



Su socio tecnológico para el mecanizado económico

MECANIZADO DE AGUJEROS



Soluciones de herramientas y proceso combinadas con amplios servicios

Nos definimos como socio tecnológico que le apoya en el desarrollo de procesos de fabricación eficientes y respetuosos con los recursos mediante herramientas estándar, conceptos de herramientas individuales y la optimización de los detalles de las herramientas. Así, nuestras herramientas satisfacen sus requisitos de seguridad en el proceso, precisión y manejo sencillo. ¿Cómo? Mediante unos avanzados métodos de desarrollo y diseño, así como mediante la producción en unas instalaciones de fabricación de vanguardia.

Además de necesitar la herramienta óptima para su tarea, ¿busca también un socio que se encargue de la planificación y coordinación completas del proceso? También en ese caso estamos a su disposición. Le asesoramos durante todas las fases de producción y mantenemos su proceso de manufactura al más alto nivel: altamente productiva, económica y segura. Asimismo, le ofrecemos soluciones completas para todas las tareas periféricas relacionadas con el proceso de mecanizado.

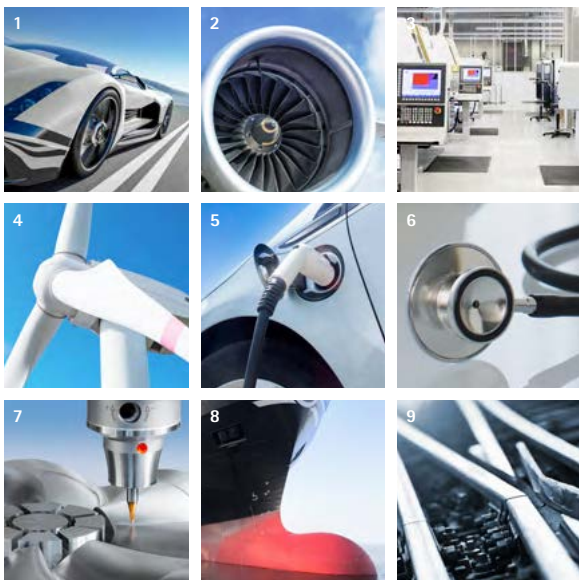

Sectores

- 1 Automotriz
- 2 Aeroespacial
- 3 Construcción de maquinaria
- 4 Generación de energía
- 5 Electromovilidad
- 6 Tecnología médica
- 7 Fabricación de moldes y troqueles
- 8 Construcción naval
- 9 Transporte ferroviario



Más de
5000
empleados en
el mundo entero

N.º 1
Líder tecnológico para
el mecanizado de
componentes cúbicos

Sucursales con producción, distribución y servicio técnico en 25 países

Representaciones en más de 19 países



Líneas de productos

- 1 Escariado y taladrado de precisión
- 2 Barrenado en sólido, mandrinado y avellanado
- 3 Fresado
- 4 Torneado
- 5 Herramientas accionadas
- 6 Sujeción
- 7 Ajuste, medición y entrega
- 8 Servicios



ÍNDICE

01 Introducción

Competencia en mecanizado de agujeros	6
Vista general del surtido	8

02 Barrenado en solido

Vista general de los productos, vista general de las series, ayuda de selección, código de denominación ..	12
Barrenado en solido	
Barrenado en solido con metal duro	29
Barrenado en solido con sistema de cabezal intercambiable ..	183
Barrenado en solido con insertos de corte	239
Taladrado	245
Taladrado escalonado	257
Taladrado profundo	267
Escariado	289
Soluciones especiales	300

03 Escariado y taladrado de precisión

Vista general de los productos	306
Escariadores fijos de múltiples filos	311
Herramientas con guías de apoyo	477
Soluciones para diámetros grandes	560
Soluciones especiales	572

04 Avellanado

Avellanadores cónicos	585
-----------------------------	-----

05 Mandrinado y torneado

Vista general de los productos	596
Soluciones especiales	598
ModulBore	613
Soporte de sujeción corto	643
Insertos de corte	663

06 Anexo técnico

Anexo técnico	737
---------------------	-----

COMPETENCIA EN MECANIZADO DE AGUJEROS

La herramienta óptima para cada aplicación

Partiendo de la fabricación de herramientas especiales para soluciones de mecanizado a medida para sus clientes, MAPAL ha desarrollado un amplio programa estándar para el mecanizado de agujeros.

MAPAL es uno de los mayores proveedores mundiales en el campo del taladrado con herramientas de metal duro. El programa de brocas de metal duro comprende soluciones para el mecanizado económico y seguro de prácticamente cualquier material, y se completa con unos modernos sistemas de cabezal intercambiable para lograr la máxima rentabilidad.

La gama para el mecanizado de precisión de agujeros incluye escariadores fijos de múltiples filos, herramientas con guías de apoyo, escariadores de un filo, el sistema EasyAdjust (sistema EA), así como insertos de corte afilados con precisión y soluciones para diámetros grandes de hasta 400 mm.

Las herramientas con insertos de corte desempeñan un papel principal en el campo del mandrinado. Los insertos de corte radiales positivos para el mandrinado y torneado son especialmente económicos. Los insertos de corte tangenciales están disponibles para los requisitos de mandrinado más exigentes.



Barrenado en solido



MAPAL ofrece un amplio programa estándar de brocas de metal duro para todas las tareas de mecanizado. Además de las herramientas de dos y tres cuchillas para el barrenado en solido, la gama incluye también brocas piloto, brocas escalonadas, taladros profundos y brocas escariadoras para perforar y escariar en un solo paso. Además, hay disponibles brocas de barrenado en solido con sistema de cabezal intercambiable e insertos de corte. MAPAL ofrece las brocas adecuadas para todos los materiales, ya se trate de materiales de fundición, metales no ferrosos, aceros, materiales modernos de construcción ligera o materiales difíciles de mecanizar por arranque de viruta.

Escariado y taladrado de precisión



El escariado y el taladrado de precisión son los métodos más comunes para el mecanizado de precisión de los agujeros y convence gracias a sus resultados de máxima precisión. En función del grado de complejidad del mecanizado y de las exigencias en cuanto a precisión y superficie, MAPAL ofrecerá la solución adecuada.

Los escariadores fijos de múltiples filos permiten altos valores de avance y reducen enormemente el tiempo de mecanizado. La gama incluye escariadores monobloque de metal duro, cermet o HSS, así como escariadores de cabezal intercambiable HPR con unión HFS de alta precisión. Se dispone de un programa HPR modular para el mecanizado de grandes diámetros de hasta 400 mm.

Las herramientas con guías de apoyo garantizan la máxima precisión. Además de los escariadores de un filo, el programa estándar incluye el sistema EasyAdjust para el ajuste sencillo de herramientas en el menor tiempo posible e insertos de corte de afilado preciso.

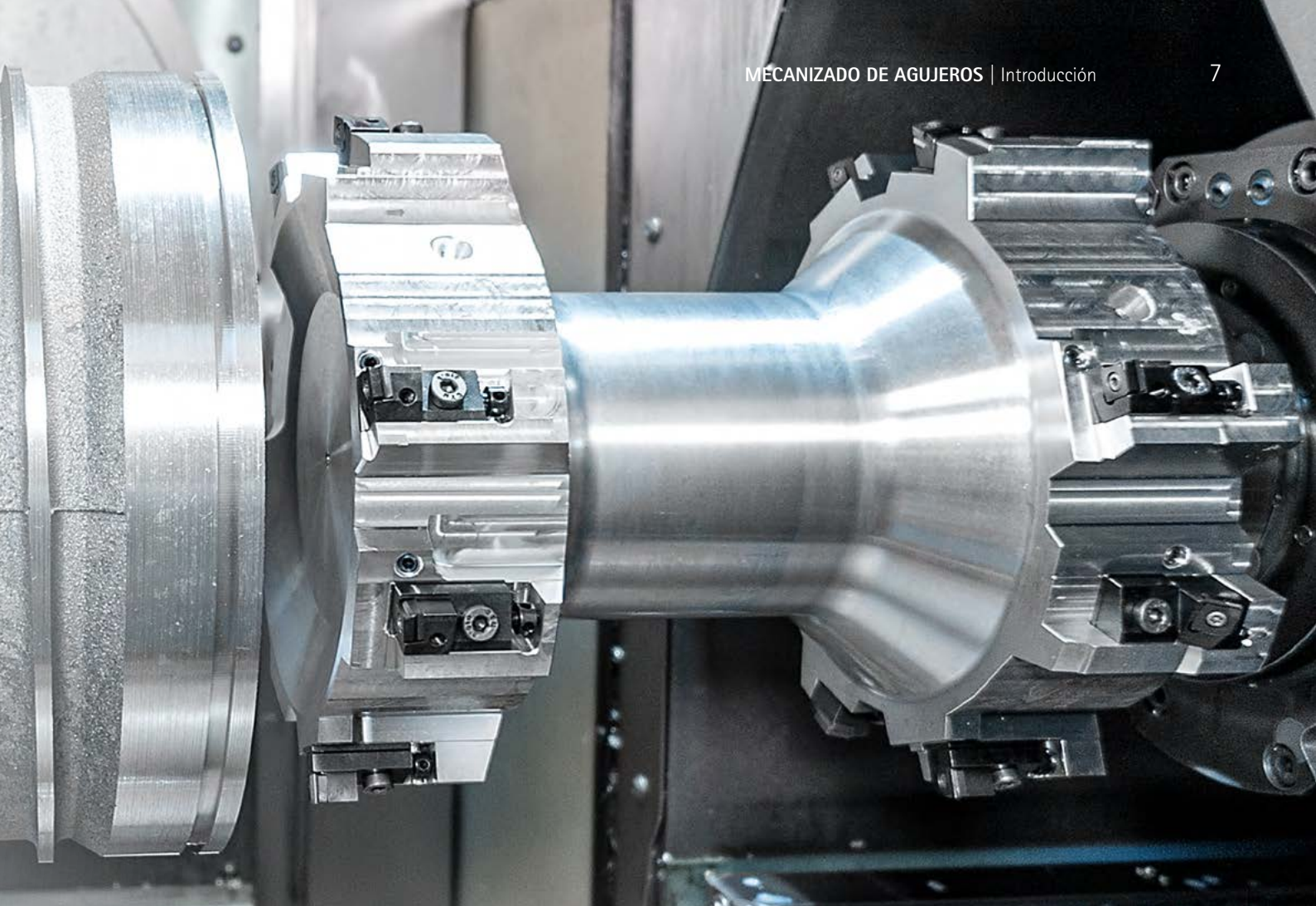

Avellanado



Con los avellanadores cónicos divididos de forma extremadamente irregular, MAPAL ha establecido un nuevo estándar en el campo del avellanado. Los avellanadores cónicos, que están disponibles en variantes de acero rápido y metal duro, trabajan con fuerzas axiales y radiales significativamente reducidas en comparación con los avellanadores cónicos convencionales. Las ventajas resultantes son una mejor superficie, una mayor duración de las herramientas y unas óptimas uniones atornilladas y remachadas.

Mandrinado y torneado



MAPAL ofrece diferentes conceptos y soluciones de herramientas para el mandrinado y el torneado. Optimizados para diferentes requisitos, ofrecen flexibilidad, rentabilidad y seguridad en el proceso incluso en situaciones de mecanizado exigentes. La gama incluye, entre otros componentes, un soporte de sujeción corto, insertos de corte radiales y tangenciales, soluciones individuales con insertos o insertos de corte de PCD y el programa Modul-Bore para el mandrinado, que se adapta específicamente a las necesidades de cada cliente.

VISTA GENERAL DEL PROGRAMA



1 | Barrenado en sólido

- 1.1 Barrenado en sólido con metal duro (a partir de la página 29)
- 1.2 Barrenado en sólido con sistema de cabezal intercambiable (a partir de la página 183)
 - Barrenado en sólido con insertos de corte (a partir de la página 239)
- 1.3 Taladrado (a partir de la página 245)
- 1.4 Taladrado escalonado (a partir de la página 257)
- 1.5 Taladrado profundo (a partir de la página 267)
- 1.6 Escariado (a partir de la página 289)

2 | Escariado y taladrado de precisión

- 2.1 Escariador de alto rendimiento | FXR (a partir de la página 316)
- 2.2 Escariador de cabezal intercambiable | HPR (a partir de la página 368)
 - Escariador con filo soldado de alto rendimiento | MOR/MRF (a partir de la página 350)
- 2.3 Escariador de un filo (a partir de la página 478)
- 2.4 Sistema EasyAdjust (a partir de la página 514)
- 2.5 Soluciones para diámetros grandes (a partir de la página 560)



3 | Avellanado

3.1 Avellanador cónico (a partir de la página 586)

4 | Mandrinado y torneado

4.1 Soluciones especiales con PCD (a partir de la página 598)

4.2 Soluciones especiales con insertos de corte (a partir de la página 604)

4.3 ModulBore (a partir de la página 613)

4.4 Soporte de sujeción corto (a partir de la página 643)

4.5 Insertos de corte (a partir de la página 663)

BARRENADO EN SOLIDO

Brocas óptimas para casi todas las aplicaciones y materiales.





VISTA GENERAL DE LOS PRODUCTOS

MAPAL ofrece para el barrenado en sólido un completo programa estándar para casi todas las tareas de mecanizado, compuesto por brocas fabricadas íntegramente en metal duro, así como brocas de cabezal intercambiable. El programa comprende brocas universales y herramientas para mecanizar fundición, metales no ferrosos, aceros, materiales de construcción ligera o materiales difíciles de mecanizar por arranque de viruta. Además, la oferta incluye soluciones para el mecanizado a alta velocidad y de avance elevado con tres insertos.

MAPAL ofrece brocas de PCD, especialmente diseñadas para los requisitos específicos de los clientes. También las brocas fabricadas íntegramente en metal duro y de cabezal intercambiable pueden adaptarse individualmente. El servicio de reafilado a nivel mundial garantiza la calidad original de todas las herramientas con la máxima rentabilidad.





Basic Line:
Herramientas universales, amplia gama de aplicación, costes de adquisición reducidos







Performance Line:
Herramientas de alto rendimiento, amplia gama de aplicación, alta productividad en la fabricación en serie



Expert Line:
Herramientas especializadas para aplicaciones seleccionadas, máxima precisión y productividad

Broca de barrenado en sólido			Broca piloto
			
<p>Barrenado en sólido con metal duro</p> <p>Taladro fabricado íntegramente en metal duro para casi todos los materiales en tres clases de rendimiento distintos.</p> <ul style="list-style-type: none"> - MEGA-Drill: broca de barrenado en sólido de doble filo con recubrimiento y geometría que se adaptan al material correspondiente - Tritan-Drill: broca de barrenado en sólido de tres filos para el máximo avance con cuchilla transversal con autocentrado para situaciones de taladrado difíciles - ECU-Drill: programa extremadamente rentable con una extraordinaria relación precio/rendimiento <p>Rango de Ø: 0,50 – 25,00 mm Profundidad de taladrado: 3xD 4xD 5xD 6xD 8xD 12xD</p> <p>P M K N C S H</p>	<p>Barrenado en sólido con sistema de cabezal intercambiable</p> <p>Barrenado en sólido con uso minimizado de metal duro con máxima estabilidad y precisión.</p> <ul style="list-style-type: none"> - Broca de placas de corte QTD: sistema rentable con placas de corte intercambiables - Broca de cabezal intercambiable TTD: broca de cabezal intercambiable de dos filos con cinco cabezales de taladrado distintos - Broca de cabezal intercambiable TTD-Tritan: hasta el doble de avance en comparación con brocas de cabezal intercambiable de doble filo. Alta seguridad en el proceso y estabilidad también en situaciones de taladrado difíciles <p>Rango de Ø: 9,00 – 50,00 mm Profundidad de taladrado: 1xD 1,5xD 3xD 5xD</p> <p>P M K N C S H</p>	<p>Barrenado en sólido con insertos de corte</p> <p>Broca de barrenado en sólido de aluminio con insertos de corte con recubrimiento de diamante CVD.</p> <ul style="list-style-type: none"> - Insertos de corte de tres filos con recubrimiento de diamante CVD para una máxima productividad y rentabilidad - Barrenado en sólido de AISi1 a AISi12 - Con refrigeración interna, también posibilidad de MQL - Soluciones específicas para: Ø 16 – 54,9 mm <p>Rango de Ø: 16,00 – 54,90 mm Profundidad de taladrado: Hasta 3xD</p> <p>N</p>	<p>Taladrado</p> <p>Taladrado de agujeros de centrado según DIN.</p> <ul style="list-style-type: none"> - Tritan-Spot-Drill: broca piloto de tres filos para taladrado exigente, especialmente adaptada a brocas de tres filos - ECU-Centre-Drill: taladrado de agujeros de centrado según DIN en componentes de rotación simétrica - CPD-Spot-Drill: broca de centrado de dos filos con unión CFS <p>Rango de Ø: 0,50 – 20,00 mm</p> <p>P M K S</p>
<p>Página 29</p>	<p>Página 183</p>	<p>Página 239</p>	<p>Página 245</p>



Broca escalonada	Taladro profundo	Broca escariadora	Soluciones especiales
			
<p>Taladrado escalonado</p> <p>Taladrado de agujeros lisos para roscar y biselados para roscas métricas.</p> <ul style="list-style-type: none"> - Tritan-Step-Drill: broca escalonada, de tres filos, con cuchilla transversal con autocentrado para el mecanizado de agujeros para roscar sin movimiento pendular - MEGA-Step-Drill: broca escalonada de dos filos para el taladrado de agujeros para roscar <p>Rango de Ø: 2,50 - 17,50 mm</p> <p>P M</p>	<p>Taladrado profundo</p> <p>Taladrado estable y eficiente de agujeros profundos de hasta 40xD.</p> <ul style="list-style-type: none"> - MEGA-Deep-Drill: taladro profundo con refrigeración interna para los mecanizados seguros de agujeros profundos de hasta 40xD - MEGA-Pilot-Drill: broca piloto especialmente adaptada a MEGA-Deep-Drill <p>Rango de Ø: 1,00 - 16,00 mm Profundidad de taladrado:</p> <p>12xD 20xD 25xD 30xD 40xD</p> <p>P M K N</p>	<p>Escariado</p> <p>Taladrado y escariado en un solo paso.</p> <p>Tritan-Drill-Reamer</p> <ul style="list-style-type: none"> - La solución más precisa para el escariado - Tres insertos y seis bisel guía - Cuchilla transversal con autocentrado para un comportamiento mejorado del taladrado - Gran precisión de posicionamiento - Circularidad óptima - Con refrigeración interna - Ejecuciones de tolerancia ±0,003 mm y H7 <p>Rango de Ø: 3,80 - 20,05 mm Profundidad de taladrado:</p> <p>3xD 5xD</p> <p>P K N</p>	<p>Soluciones especiales</p> <ul style="list-style-type: none"> - Soluciones especiales para aplicaciones específicas en el ámbito de las brocas fabricadas íntegramente en metal duro - Brocas de PCD diseñadas de forma óptima para el mecanizado de aluminio y CFK - La gama comprende desde sencillas brocas de PCD con ranuras rectas hasta brocas escalonadas de PCD en espiral - Centro de excelencia de herramientas de PCD en Pforzheim, líder a escala mundial
<p>Página 257</p>	<p>Página 267</p>	<p>Página 289</p>	<p>Página 300</p>

VISTA GENERAL DE LAS SERIES

Barrenado en sólido con metal duro

TALADRO MEGA

Taladro completo de doble filo con recubrimiento y geometría que se adaptan al material correspondiente.



MEGA-Drill

- Recubrimiento y geometría que se adaptan individualmente a cada material
- Amplia campo de aplicación
- Contiene taladro profundo, broca escalonada y microbroca para cada aplicación

Clase de producto: Idoneidad del material: Profundidad de taladrado:

Perforance
LINE

P M K
N C S H

3xD 4xD
5xD 8xD 12xD

Rango de Ø: 0,50 - 25,00 mm



MEGA-Speed-Drill

- Broca de alta velocidad con dos insertos
- Perfil de ranura muy finamente afilado para rápida retirada de virutas
- Tres bisel guía reducen la fricción y las vibraciones

Clase de producto: Idoneidad del material: Profundidad de taladrado:

Expert
LINE

P M
K S

3xD 8xD
8xD 12xD

Rango de Ø: 3,00 - 20,00 mm



MEGA-Quadro-Drill

- Cuatro bisel guía para una máxima calidad de agujero, coaxialidad y exactitud de posición
- Circularidad óptima y tolerancias diametrales

Clase de producto: Idoneidad del material: Profundidad de taladrado:

Perforance
LINE

P
K

5xD
8xD 12xD

Rango de Ø: 3,00 - 20,00 mm



MEGA-180°-Drill

- Barrenado en sólido con fondo del agujero plano
- Taladrado en superficies inclinadas de hasta 45°

Clase de producto: Idoneidad del material: Profundidad de taladrado:

Expert
LINE

P M
K N

3xD
5xD

Rango de Ø: 3,00 - 20,00 mm



BOCA TRITAN

Taladro completo de tres filos para el máximo avance con cuchilla transversal con autocentrado para situaciones de taladrado difíciles.



BROCA ECU

Programa extremadamente rentable con una extraordinaria relación precio/rendimiento.



Tritan-Drill

- Herramientas robustas con esquinas estables de los insertos
- Sin movimientos pendulares durante el mecanizado
- Óptima retirada de virutas



Clase de producto: Idoneidad del material: Profundidad de taladrado:



Rango de Ø: 4,00 - 20,00 mm

ECU-Drill

- Programa rentable
- Material de corte y recubrimientos especialmente adaptados al material



Clase de producto: Idoneidad del material: Profundidad de taladrado:



Rango de Ø: 3,00 - 20,00 mm

SELECCIÓN DE UNA BROCA

Paso a paso hasta la broca correcta

Por ejemplo, ¿busca un taladro completo para el mecanizado de acero templado? Esta ayuda de selección le guía paso a paso hasta la broca correcta.

1	Uso	Seleccione su aplicación principal.	➤		Barrenado en sólido		Taladrado	
2	Diseño	Seleccione su ejecución de herramienta preferida.	➤		Monolítico		Interfaz QTS	
3	Clase de productos	Decidase por una clase de productos.	➤	 Basic Line: Herramientas universales, amplia gama de aplicación, costes de adquisición reducidos				
4	Idoneidad del material	Determine el material de la pieza según los grupos de material que mecanizar de MAPAL (grupos de mecanizado de virutas de Mapal). El grupo de mecanizado está en la página desplegable al final del catálogo.	➤		Acero		Acero inoxidable	
5	Características del componente	Compruebe los requisitos que debe cumplir su herramienta debido a las características del agujero.	➤		Mecanizado de alto avance		Mecanizado a alta velocidad	
			➤		Tolerancia de taladrado alcanzable $\geq IT$		Serie preferente en H7	
6	Ejecución	Compruebe si las características de la geometría satisfacen sus requisitos.	➤	Rango de diámetros	Número de insertos			
7	Producto	Seleccione su broca. Los productos de la serie preferente disponible en stock se podrán suministrar en poco tiempo, mientras que los productos con características configurables se podrán configurar libremente dentro de los límites establecidos.	➤					Serie preferente disponible en stock



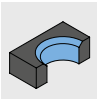

Taladrado escalonado

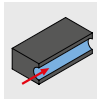

Taladrado profundo

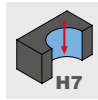

Escariado



Interfaz TTS



Interfaz CFS



Con inserto de corte



Performance Line:
Herramientas de alto rendimiento, amplia gama de aplicación, alta productividad en la fabricación en serie



Expert Line:
Herramientas especializadas para aplicaciones seleccionadas, máxima precisión y productividad



Hierro fundido



Metales no ferrosos y plásticos

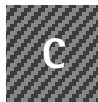

Materiales compuestos



Superalloys y titanio

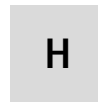

Acero templado y fundición de acero

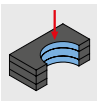

Taladrado de paquetes

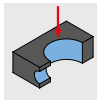

Taladrado transversal

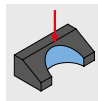

Entrada inclinada en el agujero

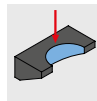

Salida inclinada del agujero

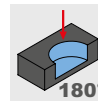

Fondo del agujero plano



Tolerancia del diámetro de afilado de la herramienta



Profundidad de taladrado máxima

Número de biseles guía



Suministro de refrigerante



Producto con características configurables

BORE MACHINING | Drilling from solid 19

Step 1: Application Step 2: Design Step 3: Product category Step 4: Material suitability Step 5: Part features Step 6: Design

Design				Product			
ø [mm]	z	ngc*		Product name	Specification		Page
3 - 25	2	2	✓	MEGA-Drill-Steel-Plus	SCD600, 601		51
2 - 20	2	2	✓	MEGA-Drill-Inox	SCD120, 121		129
2,8 - 20	2	2	✓	MEGA-Drill-Alu	SCD131		151
2,55 - 20	2	2	✓	MEGA-Drill-Hardened	SCD140		82
0,5 - 12	2	2		MEGA-Drill-Composite-IMP	SCD250		156
0,8 - 2,99	2	2	✓	MICRO-Drill-Steel	SCD371		79

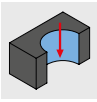

Barrenado en solido (1/2)

Diseño	Clase de productos	Idoneidad del material						Características del agujero							Profundidad de taladrado					
		P	M	K	N	C	S	H	HFC	HSC	180°	Tolerancia	3xD	4xD	5xD	6xD	8xD	12xD		
Performance LINE	Performance LINE	■	■	■	■	■	■	■			✓	✓		IT9	✓		✓		✓	
		■	■	■	■	■	■	■						IT9	✓		✓		✓	
		■	■	■	■	■	■	■						IT9	✓		✓		✓	✓
		■	■	■	■	■	■	■						IT9		✓				
		■	■	■	■	■	■	■						IT9			✓			
		■	■	■	■	■	■	■						IT9			✓		✓	✓
		■	■	■	■	■	■	■				✓			IT9			✓		✓
Expert LINE	Expert LINE	■	■	■	■	■	■	■	✓		✓	✓	✓	IT9			✓		✓	✓
		■	■	■	■	■	■	■	✓		✓	✓	✓	IT9	✓		✓		✓	✓
		■	■	■	■	■	■	■		✓				IT9	✓		✓		✓	
		■	■	■	■	■	■	■		✓				IT9	✓		✓		✓	✓
		■	■	■	■	■	■	■		✓				IT9			✓		✓	✓
		■	■	■	■	■	■	■		✓				IT9			✓			
		■	■	■	■	■	■	■						IT9	✓		✓			
		■	■	■	■	■	■	■						IT9	✓		✓			
		■	■	■	■	■	■	■						IT9			✓			
Basic LINE	Basic LINE	■	■	■	■	■	■	■					IT9		✓		✓			
		■	■	■	■	■	■	■					IT9	✓		✓		✓	✓	
		■	■	■	■	■	■	■					IT9			✓		✓		

■ muy adecuado

■ adecuado con restricciones

Paso 1:
Uso

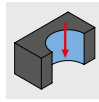

Paso 2:
Diseño



Paso 3:
Clase de productos



Paso 4:
Idoneidad del material



Paso 5:
Características del componente



Paso 6:
Ejecución



	Ejecución				Producto			
	∅ [mm]	z	η _{FF} *		Nombre de producto	Especificación		Página
	3 - 25	2	2	✓	MEGA-Drill-Steel-Plus	SCD600, 601		51
	2 - 20	2	2	✓	MEGA-Drill-Inox	SCD120, 121		129
	2,8 - 20	2	2	✓	MEGA-Drill-Alu	SCD131		151
	2,55 - 20	2	2		MEGA-Drill-Hardened	SCD140		82
	0,5 - 12	2	2		MEGA-Drill-Composite-MD	SCD250		156
	0,8 - 2,99	2	2	✓	MICRO-Drill-Steel	SCD371		79
	3 - 20	2	4	✓	MEGA-Quadro-Drill-Plus	SCD610, 611		70
	4 - 20	3	3	✓	Tritan-Drill-Uni-Plus	SCD631		30
	4 - 20	3	3	✓	Tritan-Drill-Steel	SCD661		85
	3 - 20	2	3	✓	MEGA-Speed-Drill-Uni	SCD221		36
	3 - 20	2	3	✓	MEGA-Speed-Drill-Steel	SCD621		95
	3 - 20	2	3	✓	MEGA-Speed-Drill-Inox	SCD411		142
	3 - 20	2	3	✓	MEGA-Speed-Drill-Iron	SCD421		150
	3 - 20	2	4	✓	MEGA-180°-Drill	SCD231		105
	3 - 20	2	4	✓	MEGA-180°-Drill-Alu	SCD241		160
	3 - 12	2	2		MEGA-Drill-Composite-UDX	SCD270, 271		158
	3 - 20	2	2	✓	ECU-Drill-Uni	SCD350, 351		42
	3 - 20	2	2	✓	ECU-Drill-Steel	SCD360, 361		111
	4,8 - 11,6	2	4	✓	ECU-G-Drill	SCD211		164

* η_{FF} = Número de biseles guía

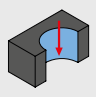









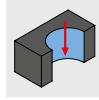







Barrenado en solido (2/2)

Diseño	Clase de productos	Idoneidad del material						Características del agujero							Profundidad de taladrado												
		P	M	K	N	C	S	H	HFC	HSC	1	2	3	4	5	180°	Tolerancia	1xD	1,5xD	3xD	5xD	8xD	12xD				
	Performance LINE	■		■														IT9	✓		✓	✓	✓	✓			
		■		■															IT9	✓		✓	✓	✓	✓		
		■	■	■	■		■												IT9	✓		✓	✓	✓	✓		
					■															IT9	✓		✓	✓	✓	✓	
						■														IT9	✓		✓	✓	✓	✓	
	Expert LINE	■		■					✓		✓	✓	✓	✓				IT9			✓	✓	✓				
		■		■							✓	✓							IT10		✓	✓	✓	✓	✓		
		■		■															IT10		✓	✓	✓	✓	✓		
		■	■	■															IT10		✓	✓	✓	✓	✓		
					■															IT10		✓	✓	✓	✓	✓	
	Performance LINE				■													IT10		✓	✓	✓	✓	✓			
						■													IT10		✓	✓	✓	✓	✓		
							■												IT10		✓	✓	✓	✓	✓		
								■											IT10		✓	✓	✓	✓	✓		
									■										IT9	✓	✓	✓					

■ muy adecuado

□ adecuado con restricciones

Paso 1:
UsoPaso 2:
DiseñoPaso 3:
Clase de productosPaso 4:
Idoneidad del materialPaso 5:
Características del componentePaso 6:
Ejecución

Ejecución					Producto			
Ø [mm]	z	η _{FF} *		Nombre de producto	Especificación		Página	
12 - 45	2	4	✓	Cabezal de taladrado intercambiable TTD Uni-Plus	01P-Uni-Plus		206	
12 - 45	2	3	✓	Cabezal de taladrado intercambiable TTD Steel	04-Steel		207	
12 - 45	2	3	✓	Cabezal de taladrado intercambiable TTD Inox	02-Inox		209	
12 - 45	2	4	✓	Cabezal de taladrado intercambiable TTD Iron	05-Iron		211	
12 - 45	2	4	✓	Cabezal de taladrado intercambiable TTD Alu	03-Alu		212	
12 - 32,49	3	3	✓	Cabezal de taladrado intercambiable TTD-Tritan Uni	01-Uni		230	
9 - 50	2	2	✓	Placa de corte QTD Steel	01-Steel		186	
14 - 32	2	2	✓	Placa de corte QTD Steel-Pyramid	05-Pyramid		188	
10 - 33	2	2	✓	Placa de corte QTD Uni, forma EK	10-Uni		190	
9 - 50	2	2	✓	Placa de corte QTD Inox	02-Inox		191	
9 - 50	2	2	✓	Placa de corte QTD Iron	04-Iron		193	
9 - 50	2	2	✓	Placa de corte QTD Alu	03-Alu		194	
16 - 54,9	1	4	✓	Inserto de corte WOGT	WOGT-X40		241	

* η_{FF} = Número de biseles guía

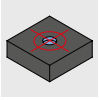

Taladrado

Diseño	Clase de productos	Idoneidad del material						Características del agujero							Profundidad de taladrado									
		P	M	K	N	C	S	H	HFC	HSC	Flute	Flute	Flute	Flute	Flute	180°	Tolerancia	1xD	1,5xD	3xD	5xD	8xD	12xD	
	Expert LINE	■	■	■	■	■	■	■																
	Basic LINE	■	■	■	■	■	■	■																
	Basic LINE	■	■	■	■	■	■	■																

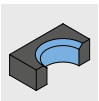

Taladrado escalonado

Diseño	Clase de productos	Idoneidad del material						Características del agujero							Profundidad de taladrado									
		P	M	K	N	C	S	H	HFC	HSC	Flute	Flute	Flute	Flute	Flute	180°	Tolerancia	1xD	1,5xD	3xD	5xD	8xD	12xD	
	Expert LINE	■	■	■	■	■	■	■	✓								IT9							
	Performance LINE	■	■	■	■	■	■	■									IT9							



Taladrado profundo

Diseño	Clase de productos	Idoneidad del material						Características del agujero							Profundidad de taladrado									
		P	M	K	N	C	S	H	HFC	HSC	Flute	Flute	Flute	Flute	Flute	180°	Tolerancia	15xD	20xD	25xD	30xD	40xD		
	Performance LINE	■	■	■	■	■	■	■																
	Performance LINE	■	■	■	■	■	■	■							✓		IT9	✓	✓	✓	✓	✓		
	Performance LINE	■	■	■	■	■	■	■						✓		IT9		✓	✓	✓	✓			



Escariado

Diseño	Clase de productos	Idoneidad del material						Características del agujero							Profundidad de taladrado									
		P	M	K	N	C	S	H	HFC	HSC	Flute	Flute	Flute	Flute	Flute	180°	Tolerancia	1xD	1,5xD	3xD	5xD	8xD	12xD	
	Expert LINE	■	■	■	■	■	■	■			✓	✓	✓	✓		IT7				✓	✓			

■ muy adecuado

▣ adecuado con restricciones

Paso 1:
Uso

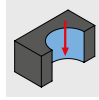

Paso 2:
Diseño



Paso 3:
Clase de productos



Paso 4:
Idoneidad del material



Paso 5:
Características del componente



Paso 6:
Ejecución



Ejecución				Producto			
Ø [mm]	z	η _{FF} *		Nombre de producto	Especificación		Página
4 - 20	3	0		Tritan-Spot-Drill-Steel	SCD670		246
0,5 - 2,5	2	2		ECU-Centre-Drill	SCD450		248
8 - 20	2	0		CPD-Spot-Drill	CPD100		249

Ejecución				Producto			
Ø [mm]	z	η _{FF} *		Nombre de producto	Especificación		Página
3,98 - 17,50	3	3	✓	Tritan-Step-Drill-Steel	SCD561		258
2,5 - 14	2	2	✓	MEGA-Step-Drill-Steel-Plus	SCD590, 591		259

Ejecución				Producto			
Ø [mm]	z	η _{FF} *		Nombre de producto	Especificación		Página
1 - 3	2	2	✓	MEGA-Pilot-Drill	SCD581		268
1 - 16	2	4	✓	MEGA-Deep-Drill	SCD171		269
3 - 12	2	4	✓	MEGA-Deep-Drill-Alu	SCD181		278

Ejecución				Producto			
Ø [mm]	z	η _{FF} *		Nombre de producto	Especificación		Página
3,80 - 20,05	3		✓	Tritan-Drill-Reamer	SDR301		292

* η_{FF} = Número de biselos guía

Código de denominación

Broca fabricada por completo en metal duro

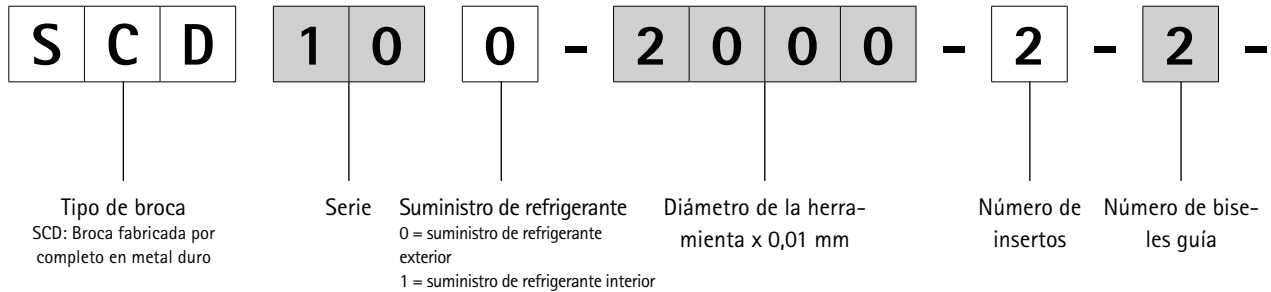

Broca escariadora

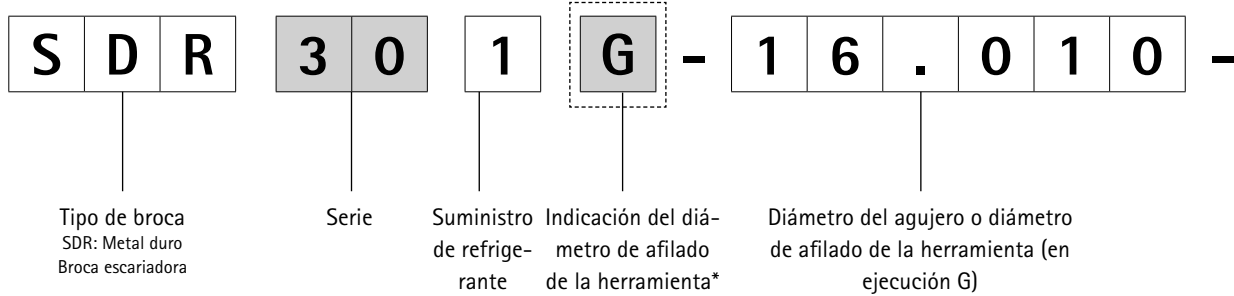

Sistemas intercambiables QTD y TTD

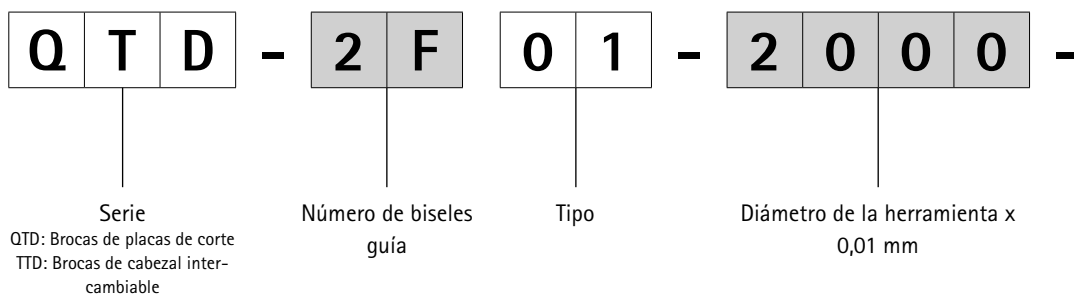

* Dígito solo utilizado para la ejecución G

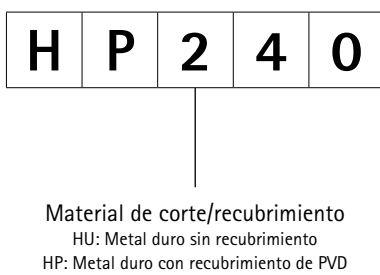
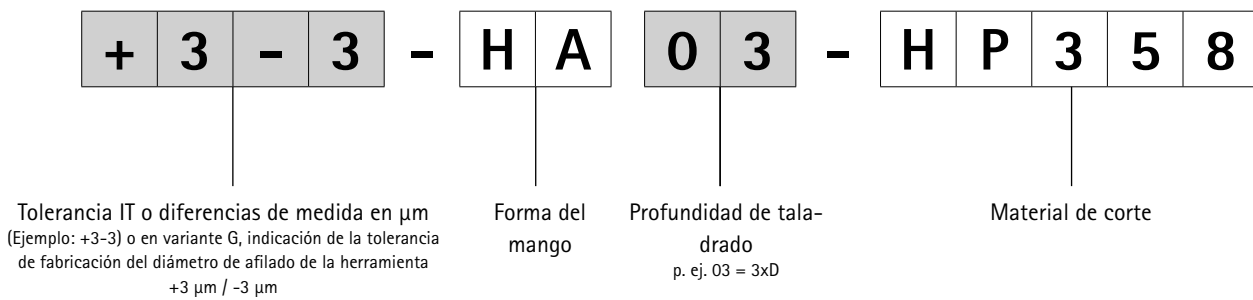
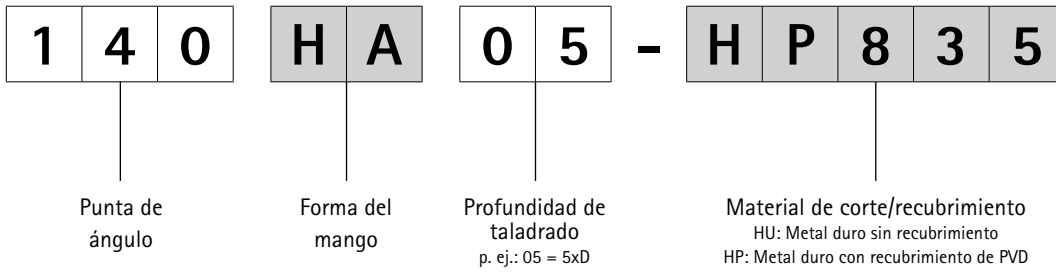

Código de denominación

Sistema de cambio TTD-Tritan

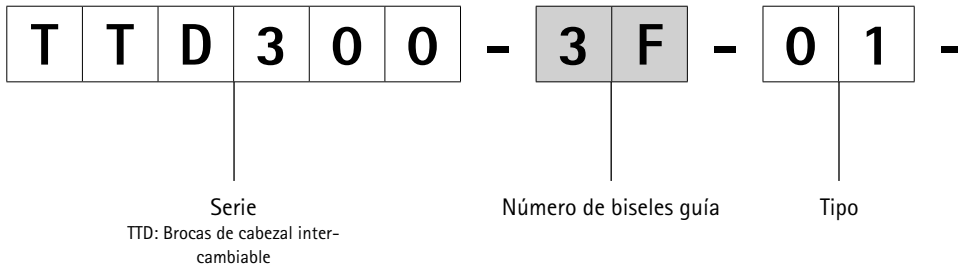

Programa de portaherramientas TTS para TTD-Tritan

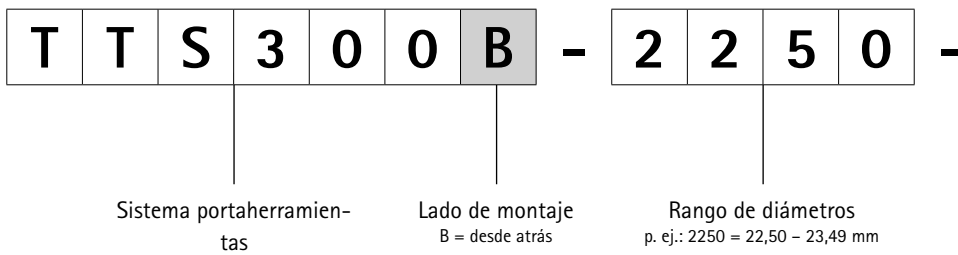

Programa de portaherramientas QTS para QTD

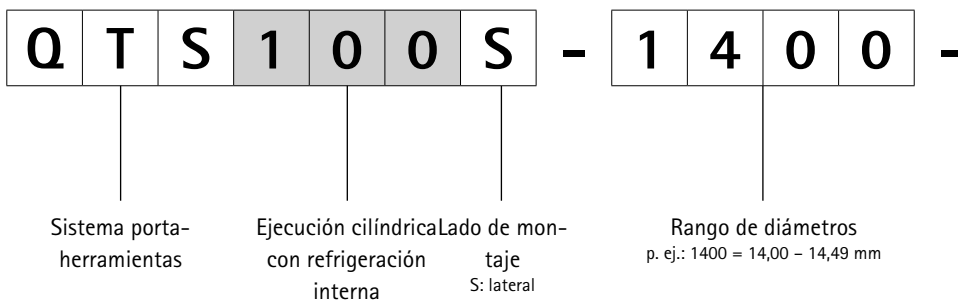

Programa de portaherramientas TTS para TTD

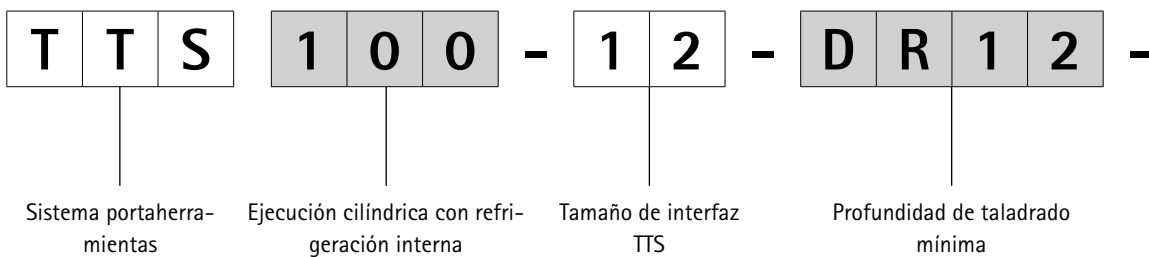

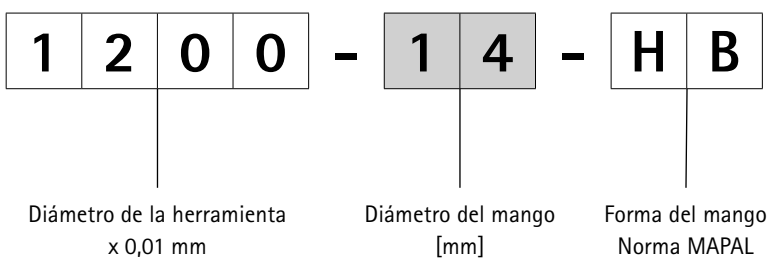
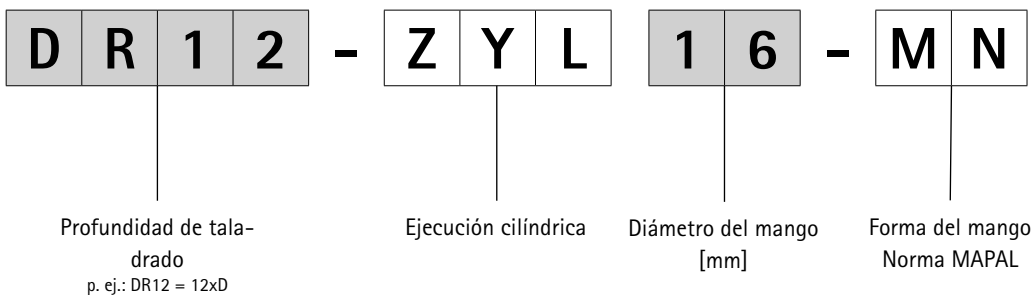
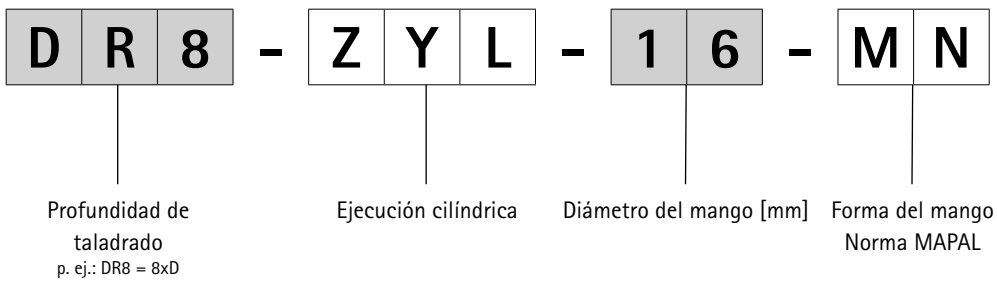
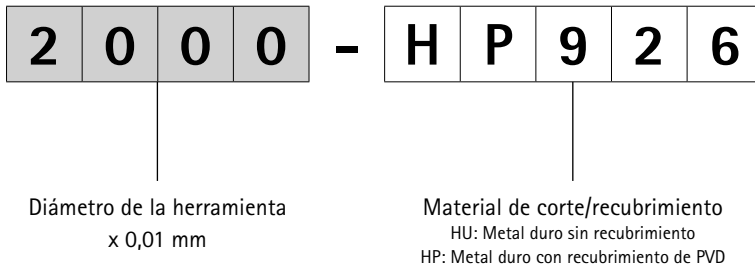



BARRENADO EN SOLIDO CON METAL DURO

Uso universal

Tritan-Drill-Uni-Plus	30
MEGA-Speed-Drill-Uni	36
ECU-Drill-Uni	42

Acero y acero templado

MEGA-Drill-Steel-Plus	51
MEGA-Quadro-Drill-Plus	70
MICRO-Drill-Steel	79
MEGA-Drill-Hardened	82
Tritan-Drill-Steel	85
MEGA-Speed-Drill-Steel	95
MEGA-180°-Drill	105
ECU-Drill-Steel	111

Acero inoxidable y hierro fundido

MEGA-Drill-Inox	129
MEGA-Speed-Drill-Inox	142
MEGA-Speed-Drill-Iron	150

Aluminio y materiales compuestos

MEGA-Drill-Alu	151
MEGA-Drill-Composite-MD	156
MEGA-Drill-Composite-UDX	158
MEGA-180°-Drill-Alu	160
ECU-G-Drill	164

Anexo técnico

Recomendación de valores de corte	166
---	-----



Tritan-Drill-Uni-Plus

Broca helicoidal de metal duro

SCD631 (5xD), suministro de refrigerante interior, producto sucesor de la Tritan-Drill-Uni (SCD44)

Ejecución:

Diámetro de broca: 4,00 – 20,00 mm
 Tolerancia del agujero: IT 9 (alcanzable)
 Material de corte: HP358
 Número de insertos: 3
 Número de bisel guía: 3
 Ángulo de la punta: 140°
 Ángulo de hélice: 30°

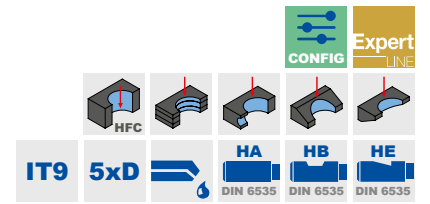
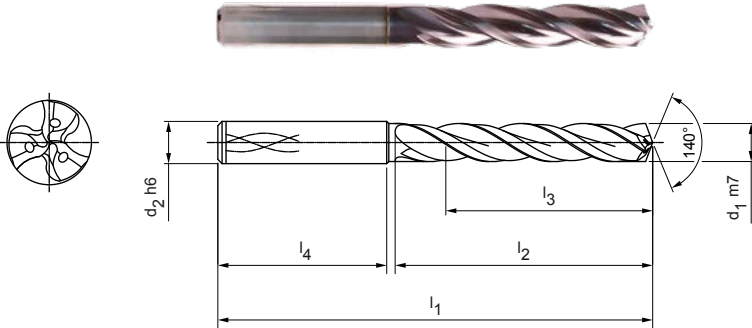

Serie preferente disponible en stock en forma de mango HA

Dimensiones						Forma del mango HA	
d ₁ m7	d ₂ h6	l ₁	l ₂	l ₃	l ₄	Especificación	Referencia
4,00	6	74	36	29	36	SCD631-0400-3-3-140HA05-HP358	31037282
4,10	6	74	36	29	36	SCD631-0410-3-3-140HA05-HP358	31037283
4,20	6	74	36	29	36	SCD631-0420-3-3-140HA05-HP358	31037284
4,30	6	74	36	29	36	SCD631-0430-3-3-140HA05-HP358	31037285
4,50	6	74	36	29	36	SCD631-0450-3-3-140HA05-HP358	31037287
4,80	6	82	44	35	36	SCD631-0480-3-3-140HA05-HP358	31037290
5,00	6	82	44	35	36	SCD631-0500-3-3-140HA05-HP358	31037292
5,10	6	82	44	35	36	SCD631-0510-3-3-140HA05-HP358	31037293
5,20	6	82	44	35	36	SCD631-0520-3-3-140HA05-HP358	31037294
5,30	6	82	44	35	36	SCD631-0530-3-3-140HA05-HP358	31037295
5,50	6	82	44	35	36	SCD631-0550-3-3-140HA05-HP358	31037297
5,55	6	82	44	35	36	SCD631-0555-3-3-140HA05-HP358	31307521
5,60	6	82	44	35	36	SCD631-0560-3-3-140HA05-HP358	31037298
5,70	6	82	44	35	36	SCD631-0570-3-3-140HA05-HP358	31037299
5,80	6	82	44	35	36	SCD631-0580-3-3-140HA05-HP358	31037300
5,90	6	82	44	35	36	SCD631-0590-3-3-140HA05-HP358	31037301
6,00	6	82	44	35	36	SCD631-0600-3-3-140HA05-HP358	31037302
6,10	8	91	53	43	36	SCD631-0610-3-3-140HA05-HP358	31037303
6,20	8	91	53	43	36	SCD631-0620-3-3-140HA05-HP358	31037304
6,30	8	91	53	43	36	SCD631-0630-3-3-140HA05-HP358	31037305
6,40	8	91	53	43	36	SCD631-0640-3-3-140HA05-HP358	31037306
6,50	8	91	53	43	36	SCD631-0650-3-3-140HA05-HP358	31037307
6,70	8	91	53	43	36	SCD631-0670-3-3-140HA05-HP358	31037309
6,80	8	91	53	43	36	SCD631-0680-3-3-140HA05-HP358	31037310
6,90	8	91	53	43	36	SCD631-0690-3-3-140HA05-HP358	31037311
7,00	8	91	53	43	36	SCD631-0700-3-3-140HA05-HP358	31037312
7,40	8	91	53	43	36	SCD631-0740-3-3-140HA05-HP358	31037316
7,50	8	91	53	43	36	SCD631-0750-3-3-140HA05-HP358	31037317
7,70	8	91	53	43	36	SCD631-0770-3-3-140HA05-HP358	31037319
7,80	8	91	53	43	36	SCD631-0780-3-3-140HA05-HP358	31037320
7,90	8	91	53	43	36	SCD631-0790-3-3-140HA05-HP358	31037321
8,00	8	91	53	43	36	SCD631-0800-3-3-140HA05-HP358	31037322
8,10	10	103	61	49	40	SCD631-0810-3-3-140HA05-HP358	31037323
8,50	10	103	61	49	40	SCD631-0850-3-3-140HA05-HP358	31037327
8,60	10	103	61	49	40	SCD631-0860-3-3-140HA05-HP358	31037328

Tritan-Drill-Uni-Plus | Broca helicoidal de metal duro SCD631 (5xD), suministro de refrigerante interior

Dimensiones						Forma del mango HA	
d ₁ m7	d ₂ h6	l ₁	l ₂	l ₃	l ₄	Especificación	Referencia
8,80	10	103	61	49	40	SCD631-0880-3-3-140HA05-HP358	31037330
9,00	10	103	61	49	40	SCD631-0900-3-3-140HA05-HP358	31037332
9,30	10	103	61	49	40	SCD631-0930-3-3-140HA05-HP358	31037335
9,50	10	103	61	49	40	SCD631-0950-3-3-140HA05-HP358	31037337
9,80	10	103	61	49	40	SCD631-0980-3-3-140HA05-HP358	31037340
9,90	10	103	61	49	40	SCD631-0990-3-3-140HA05-HP358	31037341
10,00	10	103	61	49	40	SCD631-1000-3-3-140HA05-HP358	31037342
10,20	12	118	71	56	45	SCD631-1020-3-3-140HA05-HP358	31037344
10,50	12	118	71	56	45	SCD631-1050-3-3-140HA05-HP358	31037347
11,00	12	118	71	56	45	SCD631-1100-3-3-140HA05-HP358	31037352
11,20	12	118	71	56	45	SCD631-1120-3-3-140HA05-HP358	31037354
11,50	12	118	71	56	45	SCD631-1150-3-3-140HA05-HP358	31037357
11,70	12	118	71	56	45	SCD631-1170-3-3-140HA05-HP358	31037359
11,80	12	118	71	56	45	SCD631-1180-3-3-140HA05-HP358	31037360
12,00	12	118	71	56	45	SCD631-1200-3-3-140HA05-HP358	31037362
12,50	14	124	77	60	45	SCD631-1250-3-3-140HA05-HP358	31037364
13,00	14	124	77	60	45	SCD631-1300-3-3-140HA05-HP358	31037366
13,50	14	124	77	60	45	SCD631-1350-3-3-140HA05-HP358	31037368
13,80	14	124	77	60	45	SCD631-1380-3-3-140HA05-HP358	31037369
14,00	14	124	77	60	45	SCD631-1400-3-3-140HA05-HP358	31037370
14,50	16	133	83	63	48	SCD631-1450-3-3-140HA05-HP358	31037372
14,80	16	133	83	63	48	SCD631-1480-3-3-140HA05-HP358	31037373
15,00	16	133	83	63	48	SCD631-1500-3-3-140HA05-HP358	31037374
15,50	16	133	83	63	48	SCD631-1550-3-3-140HA05-HP358	31037376
16,00	16	133	83	63	48	SCD631-1600-3-3-140HA05-HP358	31037378
17,00	18	143	93	71	48	SCD631-1700-3-3-140HA05-HP358	31037382
17,50	18	143	93	71	48	SCD631-1750-3-3-140HA05-HP358	31037384
18,00	18	143	93	71	48	SCD631-1800-3-3-140HA05-HP358	31037386
18,50	20	153	101	77	50	SCD631-1850-3-3-140HA05-HP358	31037388
19,80	20	153	101	77	50	SCD631-1980-3-3-140HA05-HP358	31037393
20,00	20	153	101	77	50	SCD631-2000-3-3-140HA05-HP358	31037394

Características configurables



Diámetro:
Diámetro seleccionable libremente en incrementos de 0,01 mm





Forma del mango:
Forma del mango: HB | HE

Especificación
SCD631-[diámetro]-3-3-140[forma del mango]05-HP358

Dimensiones de la serie configurable

d ₁ min.	d ₁ max.	d ₂ h6	l ₁	l ₂	l ₃	l ₄
4,00	4,70	6	74	36	29	36
4,71	6,00	6	82	44	35	36
6,01	8,00	8	91	53	43	36
8,01	10,00	10	103	61	49	40
10,01	12,00	12	118	71	56	45
12,01	14,00	14	124	77	60	45
14,01	16,00	16	133	83	63	48
16,01	18,00	18	143	93	71	48
18,01	20,00	20	153	101	77	50

Ejemplo:

SCD631-0431-3-3-140HE05-HP358

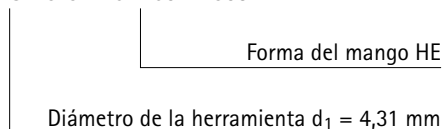

Medidas en mm.

Para la recomendación de valores de corte, véase al final del capítulo.

Ejecuciones especiales y otros recubrimientos a petición.

Tritan-Drill-Uni-Plus

Broca helicoidal de metal duro

SCD631 (8xD), suministro de refrigerante interior, producto sucesor de la Tritan-Drill-Uni (SCD44)

Ejecución:

Diámetro de broca: 4,00 – 20,00 mm
 Tolerancia del agujero: IT 9 (alcanzable)
 Material de corte: HP358
 Número de insertos: 3
 Número de biseles guía: 3
 Ángulo de la punta: 135°
 Ángulo de hélice: 30°

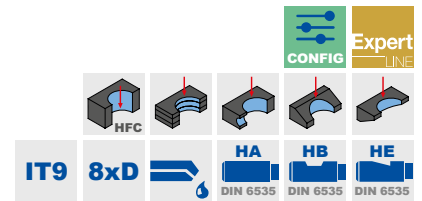
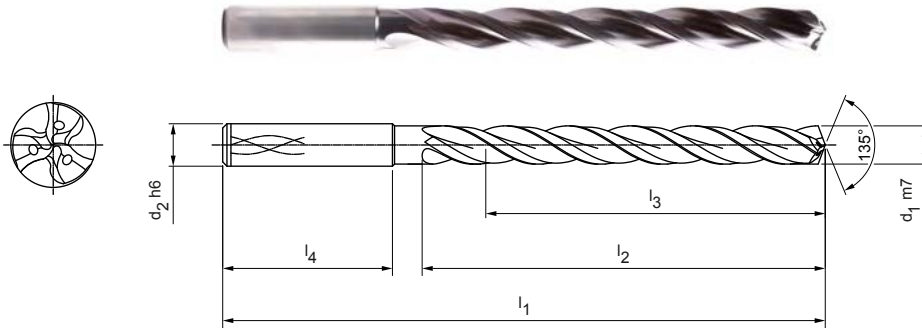

Serie preferente disponible en stock en forma de mango HA

Dimensiones						Forma del mango HA	
d ₁ m7	d ₂ h6	l ₁	l ₂	l ₃	l ₄	Especificación	Referencia
4,00	6	81	43	36	36	SCD631-0400-3-3-135HA08-HP358	31037395
4,10	6	81	43	36	36	SCD631-0410-3-3-135HA08-HP358	31037396
4,30	6	81	43	36	36	SCD631-0430-3-3-135HA08-HP358	31037398
4,50	6	81	43	36	36	SCD631-0450-3-3-135HA08-HP358	31037400
4,60	6	81	43	36	36	SCD631-0460-3-3-135HA08-HP358	31037401
4,70	6	81	43	36	36	SCD631-0470-3-3-135HA08-HP358	31037402
4,90	6	95	57	48	36	SCD631-0490-3-3-135HA08-HP358	31037404
5,00	6	95	57	48	36	SCD631-0500-3-3-135HA08-HP358	31037405
5,03	6	95	57	48	36	SCD631-0503-3-3-135HA08-HP358	31266415
5,10	6	95	57	48	36	SCD631-0510-3-3-135HA08-HP358	31037406
5,20	6	95	57	48	36	SCD631-0520-3-3-135HA08-HP358	31037407
5,50	6	95	57	48	36	SCD631-0550-3-3-135HA08-HP358	31037410
5,60	6	95	57	48	36	SCD631-0560-3-3-135HA08-HP358	31037411
5,80	6	95	57	48	36	SCD631-0580-3-3-135HA08-HP358	31037413
6,00	6	95	57	48	36	SCD631-0600-3-3-135HA08-HP358	31037415
6,10	8	114	76	64	36	SCD631-0610-3-3-135HA08-HP358	31037416
6,50	8	114	76	64	36	SCD631-0650-3-3-135HA08-HP358	31037420
6,80	8	114	76	64	36	SCD631-0680-3-3-135HA08-HP358	31037423
6,90	8	114	76	64	36	SCD631-0690-3-3-135HA08-HP358	31037424
7,00	8	114	76	64	36	SCD631-0700-3-3-135HA08-HP358	31037425
7,10	8	114	76	64	36	SCD631-0710-3-3-135HA08-HP358	31037426
7,50	8	114	76	64	36	SCD631-0750-3-3-135HA08-HP358	31037430
7,80	8	114	76	64	36	SCD631-0780-3-3-135HA08-HP358	31037433
7,90	8	114	76	64	36	SCD631-0790-3-3-135HA08-HP358	31037434
8,00	8	114	76	64	36	SCD631-0800-3-3-135HA08-HP358	31037435
8,50	10	142	95	80	40	SCD631-0850-3-3-135HA08-HP358	31037440
8,80	10	142	95	80	40	SCD631-0880-3-3-135HA08-HP358	31037443
9,00	10	142	95	80	40	SCD631-0900-3-3-135HA08-HP358	31037445
9,10	10	142	95	80	40	SCD631-0910-3-3-135HA08-HP358	31037446
9,40	10	142	95	80	40	SCD631-0940-3-3-135HA08-HP358	31037449
9,50	10	142	95	80	40	SCD631-0950-3-3-135HA08-HP358	31037450
9,80	10	142	95	80	40	SCD631-0980-3-3-135HA08-HP358	31037453
10,00	10	142	95	80	40	SCD631-1000-3-3-135HA08-HP358	31037455
11,00	12	162	114	96	45	SCD631-1100-3-3-135HA08-HP358	31037465
11,80	12	162	114	96	45	SCD631-1180-3-3-135HA08-HP358	31037473

Tritan-Drill-Uni-Plus | Broca helicoidal de metal duro SCD631 (8xD), suministro de refrigerante interior

Dimensiones						Forma del mango HA	
d ₁ m7	d ₂ h6	l ₁	l ₂	l ₃	l ₄	Especificación	Referencia
12,00	12	162	114	96	45	SCD631-1200-3-3-135HA08-HP358	31037475
12,50	14	178	133	112	45	SCD631-1250-3-3-135HA08-HP358	31037477
13,00	14	178	133	112	45	SCD631-1300-3-3-135HA08-HP358	31037479
13,50	14	178	133	112	45	SCD631-1350-3-3-135HA08-HP358	31037481
14,00	14	178	133	112	45	SCD631-1400-3-3-135HA08-HP358	31037483
15,00	16	203	152	128	48	SCD631-1500-3-3-135HA08-HP358	31037487
16,00	16	203	152	128	48	SCD631-1600-3-3-135HA08-HP358	31037491
17,00	18	222	171	144	48	SCD631-1700-3-3-135HA08-HP358	31037495

Características configurables

**Diámetro:**

Diámetro seleccionable libremente en incrementos de 0,01 mm

**Forma del mango:**

Forma del mango: HB | HE

Especificación

SCD631-[diámetro]-3-3-140[forma del mango]08-HP358

Dimensiones de la serie configurable

d ₁ min.	d ₁ max.	d ₂ h6	l ₁	l ₂	l ₃	l ₄
4,00	4,70	6	81	43	36	36
4,71	6,00	6	95	57	48	36
6,01	8,00	8	114	76	64	36
8,01	10,00	10	142	95	80	40
10,01	12,00	12	162	114	96	45
12,01	14,00	14	178	133	112	45
14,01	16,00	16	203	152	128	48
16,01	18,00	18	222	171	144	48
18,01	20,00	20	243	190	160	50

Ejemplo:

SCD631-0431-3-3-140HE08-HP358

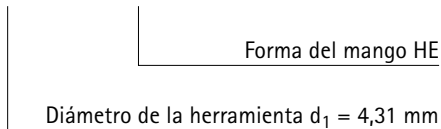

Medidas en mm.

Para la recomendación de valores de corte, véase al final del capítulo.

Ejecuciones especiales y otros recubrimientos a petición.

Tritan-Drill-Uni-Plus

Broca helicoidal de metal duro

SCD631 (12xD), suministro de refrigerante interior, producto sucesor de la Tritan-Drill-Uni (SCD44)

Ejecución:

Diámetro de broca: 4,00 – 20,00 mm
 Tolerancia del agujero: IT 9 (alcanzable)
 Material de corte: HP358
 Número de insertos: 3
 Número de bisel guía: 3
 Ángulo de la punta: 135°
 Ángulo de hélice: 30°

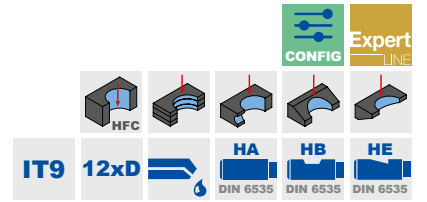
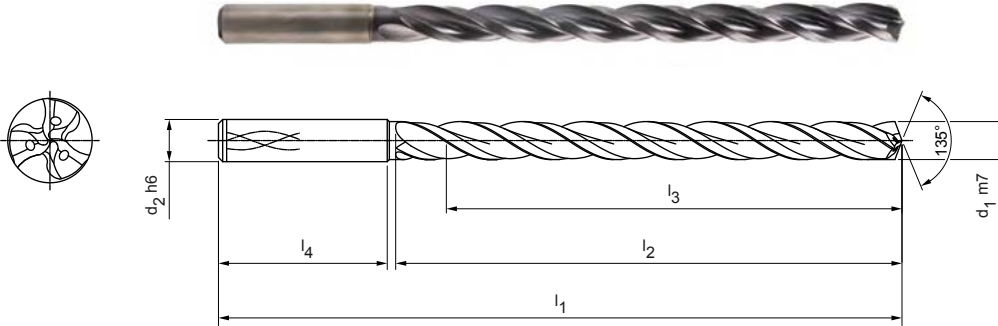

Serie preferente disponible en stock en forma de mango HA

Dimensiones						Forma del mango HA	
d ₁ m7	d ₂ h6	l ₁	l ₂	l ₃	l ₄	Especificación	Referencia
4,00	6	102	64	58	36	SCD631-0400-3-3-135HA12-HP358	31035357
4,10	6	102	64	58	36	SCD631-0410-3-3-135HA12-HP358	31035358
4,20	6	102	64	58	36	SCD631-0420-3-3-135HA12-HP358	31035359
4,30	6	102	64	58	36	SCD631-0430-3-3-135HA12-HP358	31035360
4,50	6	102	64	58	36	SCD631-0450-3-3-135HA12-HP358	31035362
4,60	6	102	64	58	36	SCD631-0460-3-3-135HA12-HP358	31035363
4,70	6	102	64	58	36	SCD631-0470-3-3-135HA12-HP358	31035364
4,80	6	116	78	70	36	SCD631-0480-3-3-135HA12-HP358	31035365
5,00	6	116	78	70	36	SCD631-0500-3-3-135HA12-HP358	31035367
5,10	6	116	78	70	36	SCD631-0510-3-3-135HA12-HP358	31035368
5,20	6	116	78	70	36	SCD631-0520-3-3-135HA12-HP358	31035369
5,40	6	116	78	70	36	SCD631-0540-3-3-135HA12-HP358	31035371
5,50	6	116	78	70	36	SCD631-0550-3-3-135HA12-HP358	31035372
5,80	6	116	78	70	36	SCD631-0580-3-3-135HA12-HP358	31035375
6,00	6	116	78	70	36	SCD631-0600-3-3-135HA12-HP358	31035377
6,10	8	146	108	94	36	SCD631-0610-3-3-135HA12-HP358	31035378
6,20	8	146	108	94	36	SCD631-0620-3-3-135HA12-HP358	31035379
6,50	8	146	108	94	36	SCD631-0650-3-3-135HA12-HP358	31035382
6,60	8	146	108	94	36	SCD631-0660-3-3-135HA12-HP358	31035383
6,80	8	146	108	94	36	SCD631-0680-3-3-135HA12-HP358	31035385
7,00	8	146	108	94	36	SCD631-0700-3-3-135HA12-HP358	31035387
7,50	8	146	108	94	36	SCD631-0750-3-3-135HA12-HP358	31035392
7,80	8	146	108	94	36	SCD631-0780-3-3-135HA12-HP358	31035395
8,00	8	146	108	94	36	SCD631-0800-3-3-135HA12-HP358	31035397
8,50	10	162	120	110	40	SCD631-0850-3-3-135HA12-HP358	31035402
9,00	10	162	120	110	40	SCD631-0900-3-3-135HA12-HP358	31035407
9,50	10	162	120	110	40	SCD631-0950-3-3-135HA12-HP358	31035412
9,80	10	162	120	110	40	SCD631-0980-3-3-135HA12-HP358	31035415
9,90	10	162	120	110	40	SCD631-0990-3-3-135HA12-HP358	31035416
10,00	10	162	120	110	40	SCD631-1000-3-3-135HA12-HP358	31035417
10,20	12	204	156	142	45	SCD631-1020-3-3-135HA12-HP358	31035419
10,50	12	204	156	142	45	SCD631-1050-3-3-135HA12-HP358	31035422
11,00	12	204	156	142	45	SCD631-1100-3-3-135HA12-HP358	31035427
11,30	12	204	156	142	45	SCD631-1130-3-3-135HA12-HP358	31035430
11,80	12	204	156	142	45	SCD631-1180-3-3-135HA12-HP358	31035435

Tritan-Drill-Uni-Plus | Broca helicoidal de metal duro SCD631 (12xD), suministro de refrigerante interior

Dimensiones						Forma del mango HA	
d ₁ m7	d ₂ h6	l ₁	l ₂	l ₃	l ₄	Especificación	Referencia
12,00	12	204	156	142	45	SCD631-1200-3-3-135HA12-HP358	31035437
12,50	14	230	182	166	45	SCD631-1250-3-3-135HA12-HP358	31035439
13,00	14	230	182	166	45	SCD631-1300-3-3-135HA12-HP358	31035441
13,50	14	230	182	166	45	SCD631-1350-3-3-135HA12-HP358	31035443
13,80	14	230	182	166	45	SCD631-1380-3-3-135HA12-HP358	31035444
14,00	14	230	182	166	45	SCD631-1400-3-3-135HA12-HP358	31035445
15,00	16	260	208	192	48	SCD631-1500-3-3-135HA12-HP358	31035449
15,80	16	260	208	192	48	SCD631-1580-3-3-135HA12-HP358	31035452
16,00	16	260	208	192	48	SCD631-1600-3-3-135HA12-HP358	31035453

Características configurables



Diámetro:
Diámetro seleccionable libremente en incrementos de 0,01 mm





Forma del mango:
Forma del mango: HB | HE

Especificación
SCD631-[diámetro]-3-3-140[forma del mango]12-HP358

Dimensiones de la serie configurable

d ₁ min.	d ₁ max.	d ₂ h6	l ₁	l ₂	l ₃	l ₄
4,00	4,70	6	102	64	58	36
4,71	6,00	6	116	78	70	36
6,01	8,00	8	146	108	94	36
8,01	10,00	10	162	120	110	40
10,01	12,00	12	204	156	142	45
12,01	14,00	14	230	182	166	45
14,01	16,00	16	260	208	192	48
16,01	18,00	18	285	234	216	48
18,01	20,00	20	310	258	240	50

Ejemplo:

SCD631-0431-3-3-140HE12-HP358

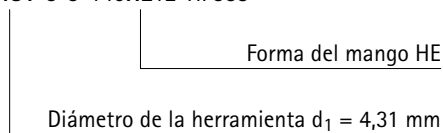

Medidas en mm.

Para la recomendación de valores de corte, véase al final del capítulo.

Ejecuciones especiales y otros recubrimientos a petición.

MEGA-Speed-Drill-Uni

Broca helicoidal de metal duro
SCD221 (3xD), suministro de refrigerante interior

Ejecución:
 Diámetro de broca: 3,00 – 20,00 mm
 Tolerancia del agujero: ≥ IT 9
 Material de corte: HP374
 Número de insertos: 2
 Número de bisel guía: 3
 Ángulo de la punta: 135°
 Ángulo de hélice: 30°

Aplicación:
 Para el mecanizado a alta velocidad.

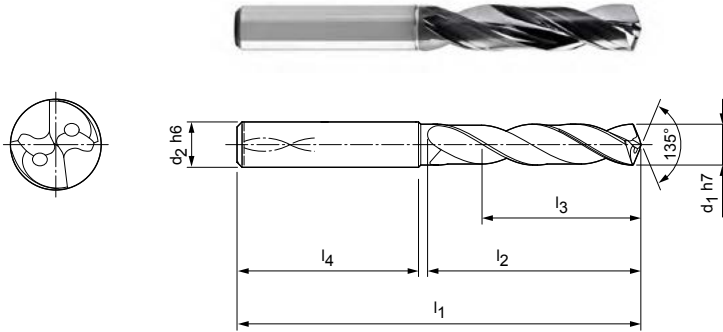

Serie preferente disponible en stock en forma de mango HA

Dimensiones						Forma del mango HA	
d ₁ h7	d ₂ h6	l ₁	l ₂	l ₃	l ₄	Especificación	Referencia
3,00	6	62	20	14	36	SCD221-0300-2-3-135HA03-HP374	30404127
3,10	6	62	20	14	36	SCD221-0310-2-3-135HA03-HP374	30404128
3,20	6	62	20	14	36	SCD221-0320-2-3-135HA03-HP374	30404129
3,30	6	62	20	14	36	SCD221-0330-2-3-135HA03-HP374	30404130
3,40	6	62	20	14	36	SCD221-0340-2-3-135HA03-HP374	30404131
3,50	6	62	20	14	36	SCD221-0350-2-3-135HA03-HP374	30404132
3,70	6	62	20	14	36	SCD221-0370-2-3-135HA03-HP374	30404134
4,00	6	66	24	17	36	SCD221-0400-2-3-135HA03-HP374	30404137
4,20	6	66	24	17	36	SCD221-0420-2-3-135HA03-HP374	30404139
4,30	6	66	24	17	36	SCD221-0430-2-3-135HA03-HP374	30404140
4,50	6	66	24	17	36	SCD221-0450-2-3-135HA03-HP374	30404142
5,00	6	66	28	20	36	SCD221-0500-2-3-135HA03-HP374	30404148
5,10	6	66	28	20	36	SCD221-0510-2-3-135HA03-HP374	30404149
5,20	6	66	28	20	36	SCD221-0520-2-3-135HA03-HP374	30404150
5,50	6	66	28	20	36	SCD221-0550-2-3-135HA03-HP374	30404153
5,55	6	66	28	20	36	SCD221-0555-2-3-135HA03-HP374	30404154
5,60	6	66	28	20	36	SCD221-0560-2-3-135HA03-HP374	30404155
5,80	6	66	28	20	36	SCD221-0580-2-3-135HA03-HP374	30404157
6,00	6	66	28	20	36	SCD221-0600-2-3-135HA03-HP374	30404159
6,30	8	79	34	24	36	SCD221-0630-2-3-135HA03-HP374	30404162
6,50	8	79	34	24	36	SCD221-0650-2-3-135HA03-HP374	30404164
6,80	8	79	34	24	36	SCD221-0680-2-3-135HA03-HP374	30404167
6,90	8	79	34	24	36	SCD221-0690-2-3-135HA03-HP374	30404168
7,00	8	79	34	24	36	SCD221-0700-2-3-135HA03-HP374	30404169
7,40	8	79	41	29	36	SCD221-0740-2-3-135HA03-HP374	30404173
7,50	8	79	41	29	36	SCD221-0750-2-3-135HA03-HP374	30404175
7,80	8	79	41	29	36	SCD221-0780-2-3-135HA03-HP374	30404178
8,00	8	79	41	29	36	SCD221-0800-2-3-135HA03-HP374	30404180
8,50	10	89	47	35	40	SCD221-0850-2-3-135HA03-HP374	30404185
8,60	10	89	47	35	40	SCD221-0860-2-3-135HA03-HP374	30404186
8,80	10	89	47	35	40	SCD221-0880-2-3-135HA03-HP374	30404188
9,00	10	89	47	35	40	SCD221-0900-2-3-135HA03-HP374	30404190
9,50	10	89	47	35	40	SCD221-0950-2-3-135HA03-HP374	30404195
9,80	10	89	47	35	40	SCD221-0980-2-3-135HA03-HP374	30404198
9,90	10	89	47	35	40	SCD221-0990-2-3-135HA03-HP374	30404199

MEGA-Speed-Drill-Uni | Broca helicoidal de metal duro SCD221 (3xD), suministro de refrigerante interior

Dimensiones						Forma del mango HA	
d ₁ h7	d ₂ h6	l ₁	l ₂	l ₃	l ₄	Especificación	Referencia
10,00	10	89	47	35	40	SCD221-1000-2-3-135HA03-HP374	30404200
10,20	12	102	55	40	45	SCD221-1020-2-3-135HA03-HP374	30404202
10,30	12	102	55	40	45	SCD221-1030-2-3-135HA03-HP374	30404203
10,50	12	102	55	40	45	SCD221-1050-2-3-135HA03-HP374	30404205
10,60	12	102	55	40	45	SCD221-1060-2-3-135HA03-HP374	30404206
11,00	12	102	55	40	45	SCD221-1100-2-3-135HA03-HP374	30404210
11,50	12	102	55	40	45	SCD221-1150-2-3-135HA03-HP374	30404215
11,60	12	102	55	40	45	SCD221-1160-2-3-135HA03-HP374	30404216
11,80	12	102	55	40	45	SCD221-1180-2-3-135HA03-HP374	30404219
12,00	12	102	55	40	45	SCD221-1200-2-3-135HA03-HP374	30404221
12,50	14	107	60	43	45	SCD221-1250-2-3-135HA03-HP374	30404222
13,00	14	107	60	43	45	SCD221-1300-2-3-135HA03-HP374	30404224
13,50	14	107	60	43	45	SCD221-1350-2-3-135HA03-HP374	30404225
14,00	14	107	60	43	45	SCD221-1400-2-3-135HA03-HP374	30404227
14,50	16	115	65	45	48	SCD221-1450-2-3-135HA03-HP374	30404228
15,00	16	115	65	45	48	SCD221-1500-2-3-135HA03-HP374	30404230
16,00	16	115	65	45	48	SCD221-1600-2-3-135HA03-HP374	30404233
17,00	18	123	73	51	48	SCD221-1700-2-3-135HA03-HP374	30404236
17,50	18	123	73	51	48	SCD221-1750-2-3-135HA03-HP374	30404237
17,80	18	123	73	51	48	SCD221-1780-2-3-135HA03-HP374	30404238
18,00	18	123	73	51	48	SCD221-1800-2-3-135HA03-HP374	30404239
18,50	20	131	79	55	50	SCD221-1850-2-3-135HA03-HP374	30404240
19,50	20	131	79	55	50	SCD221-1950-2-3-135HA03-HP374	30404243
20,00	20	131	79	55	50	SCD221-2000-2-3-135HA03-HP374	30404245

Características configurables

**Diámetro:**

Diámetro seleccionable libremente en incrementos de 0,01 mm

**Forma del mango:**

Forma del mango: HB | HE

Especificación

SCD221-[diámetro]-3-3-140[forma del mango]03-HP358

Dimensiones de la serie configurable

d ₁ min.	d ₁ max.	d ₂ h6	l ₁	l ₂	l ₃	l ₄
3,00	3,70	6	62	20	14	36
3,71	4,70	6	66	24	17	36
4,71	6,00	6	66	28	20	36
6,01	8,00	8	79	34	24	36
8,01	10,00	10	89	47	35	40
10,01	12,00	12	102	55	40	45
12,01	14,00	14	107	60	43	45
14,01	16,00	16	115	65	45	48
16,01	18,00	18	123	73	51	48
18,01	20,00	20	131	79	55	50

Ejemplo:

SCD221-0431-3-3-140HE03-HP358

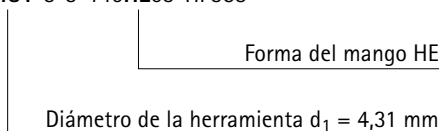

Medidas en mm.

Para la recomendación de valores de corte, véase al final del capítulo.

Ejecuciones especiales y otros recubrimientos a petición.

MEGA-Speed-Drill-Uni

Broca helicoidal de metal duro
SCD221 (5xD), suministro de refrigerante interior

Ejecución:
 Diámetro de broca: 3,00 – 20,00 mm
 Tolerancia del agujero: ≥ IT 9
 Material de corte: HP374
 Número de insertos: 2
 Número de biseles guía: 3
 Ángulo de la punta: 135°
 Ángulo de hélice: 30°

Aplicación:
 Para el mecanizado a alta velocidad.

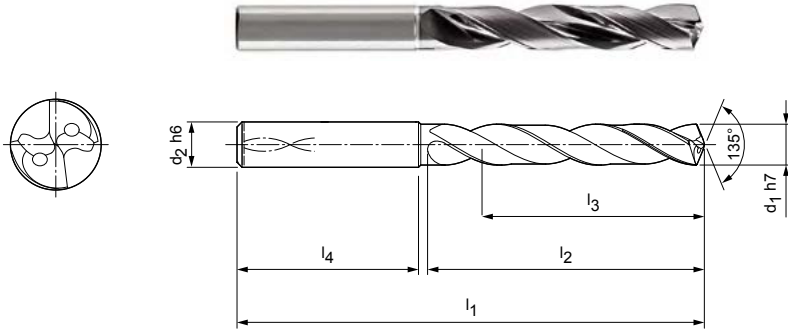

Serie preferente disponible en stock en forma de mango HA

Dimensiones						Forma del mango HA	
d ₁ h7	d ₂ h6	l ₁	l ₂	l ₃	l ₄	Especificación	Referencia
3,00	6	66	28	23	36	SCD221-0300-2-3-135HA05-HP374	30392925
3,10	6	66	28	23	36	SCD221-0310-2-3-135HA05-HP374	30392926
3,20	6	66	28	23	36	SCD221-0320-2-3-135HA05-HP374	30392927
3,30	6	66	28	23	36	SCD221-0330-2-3-135HA05-HP374	30392928
3,40	6	66	28	23	36	SCD221-0340-2-3-135HA05-HP374	30392929
3,50	6	66	28	23	36	SCD221-0350-2-3-135HA05-HP374	30392930
3,70	6	66	28	23	36	SCD221-0370-2-3-135HA05-HP374	30392932
4,00	6	74	36	29	36	SCD221-0400-2-3-135HA05-HP374	30392935
4,20	6	74	36	29	36	SCD221-0420-2-3-135HA05-HP374	30392937
4,30	6	74	36	29	36	SCD221-0430-2-3-135HA05-HP374	30392938
4,50	6	74	36	29	36	SCD221-0450-2-3-135HA05-HP374	30392940
5,00	6	82	44	35	36	SCD221-0500-2-3-135HA05-HP374	30392946
5,10	6	82	44	35	36	SCD221-0510-2-3-135HA05-HP374	30392947
5,20	6	82	44	35	36	SCD221-0520-2-3-135HA05-HP374	30392948
5,50	6	82	44	35	36	SCD221-0550-2-3-135HA05-HP374	30392951
5,60	6	82	44	35	36	SCD221-0560-2-3-135HA05-HP374	30392953
5,80	6	82	44	35	36	SCD221-0580-2-3-135HA05-HP374	30392955
6,00	6	82	44	35	36	SCD221-0600-2-3-135HA05-HP374	30392957
6,50	8	91	53	43	36	SCD221-0650-2-3-135HA05-HP374	30392962
6,60	8	91	53	43	36	SCD221-0660-2-3-135HA05-HP374	30392963
6,80	8	91	53	43	36	SCD221-0680-2-3-135HA05-HP374	30392965
6,90	8	91	53	43	36	SCD221-0690-2-3-135HA05-HP374	30392966
7,00	8	91	53	43	36	SCD221-0700-2-3-135HA05-HP374	30392967
7,40	8	91	53	43	36	SCD221-0740-2-3-135HA05-HP374	30392971
7,50	8	91	53	43	36	SCD221-0750-2-3-135HA05-HP374	30392972
7,80	8	91	53	43	36	SCD221-0780-2-3-135HA05-HP374	30392975
8,00	8	91	53	43	36	SCD221-0800-2-3-135HA05-HP374	30392977
8,50	10	103	61	49	40	SCD221-0850-2-3-135HA05-HP374	30392982
8,60	10	103	61	49	40	SCD221-0860-2-3-135HA05-HP374	30392983
8,80	10	103	61	49	40	SCD221-0880-2-3-135HA05-HP374	30392985
9,00	10	103	61	49	40	SCD221-0900-2-3-135HA05-HP374	30392987
9,50	10	103	61	49	40	SCD221-0950-2-3-135HA05-HP374	30392992
9,70	10	103	61	49	40	SCD221-0970-2-3-135HA05-HP374	30392994
9,80	10	103	61	49	40	SCD221-0980-2-3-135HA05-HP374	30392995
10,00	10	103	61	49	40	SCD221-1000-2-3-135HA05-HP374	30392997

MEGA-Speed-Drill-Uni | Broca helicoidal de metal duro SCD221 (5xD), suministro de refrigerante interior

Dimensiones						Forma del mango HA	
d ₁ h7	d ₂ h6	l ₁	l ₂	l ₃	l ₄	Especificación	Referencia
10,20	12	118	71	56	45	SCD221-1020-2-3-135HA05-HP374	30392999
10,30	12	118	71	56	45	SCD221-1030-2-3-135HA05-HP374	30393000
10,50	12	118	71	56	45	SCD221-1050-2-3-135HA05-HP374	30393002
11,00	12	118	71	56	45	SCD221-1100-2-3-135HA05-HP374	30393007
11,50	12	118	71	56	45	SCD221-1150-2-3-135HA05-HP374	30393012
11,80	12	118	71	56	45	SCD221-1180-2-3-135HA05-HP374	30393015
12,00	12	118	71	56	45	SCD221-1200-2-3-135HA05-HP374	30393017
12,50	14	124	77	60	45	SCD221-1250-2-3-135HA05-HP374	30393018
13,00	14	124	77	60	45	SCD221-1300-2-3-135HA05-HP374	30393020
13,50	14	124	77	60	45	SCD221-1350-2-3-135HA05-HP374	30393021
13,80	14	124	77	60	45	SCD221-1380-2-3-135HA05-HP374	30393022
14,00	14	124	77	60	45	SCD221-1400-2-3-135HA05-HP374	30393023
14,50	16	133	83	63	48	SCD221-1450-2-3-135HA05-HP374	30393024
15,00	16	133	83	63	48	SCD221-1500-2-3-135HA05-HP374	30393026
15,50	16	133	83	63	48	SCD221-1550-2-3-135HA05-HP374	30393027
15,80	16	133	83	63	48	SCD221-1580-2-3-135HA05-HP374	30393028
16,00	16	133	83	63	48	SCD221-1600-2-3-135HA05-HP374	30393029
16,80	18	143	93	71	48	SCD221-1680-2-3-135HA05-HP374	30393031
17,00	18	143	93	71	48	SCD221-1700-2-3-135HA05-HP374	30393032
17,50	18	143	93	71	48	SCD221-1750-2-3-135HA05-HP374	30393033
17,80	18	143	93	71	48	SCD221-1780-2-3-135HA05-HP374	30393034
18,00	18	143	93	71	48	SCD221-1800-2-3-135HA05-HP374	30393035
18,50	20	153	101	77	50	SCD221-1850-2-3-135HA05-HP374	30393036
18,80	20	153	101	77	50	SCD221-1880-2-3-135HA05-HP374	30393037
19,00	20	153	101	77	50	SCD221-1900-2-3-135HA05-HP374	30393038
20,00	20	153	101	77	50	SCD221-2000-2-3-135HA05-HP374	30393041

Características configurables



Diámetro:
Diámetro seleccionable libremente en incrementos de 0,01 mm





Forma del mango:
Forma del mango: HB | HE

Especificación
SCD221-[diámetro]-3-3-140[forma del mango]05-HP358

Dimensiones de la serie configurable

d ₁ min.	d ₁ max.	d ₂ h6	l ₁	l ₂	l ₃	l ₄
3,00	3,70	6	66	28	23	36
3,71	4,70	6	74		29	36
4,71	6,00	6	82	44	35	36
6,01	8,00	8	91	53	43	36
8,01	10,00	10	103	61	49	40
10,01	12,00	12	118	71	56	45
12,01	14,00	14	124	77	60	45
14,01	16,00	16	133	83	63	48
16,01	18,00	18	143	93	71	48
18,01	20,00	20	153	101	77	50

Ejemplo:

SCD221-0431-3-3-140HE05-HP374

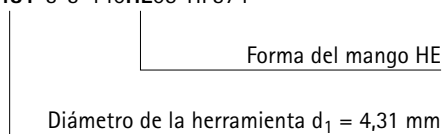

Medidas en mm.

Para la recomendación de valores de corte, véase al final del capítulo.

Ejecuciones especiales y otros recubrimientos a petición.

MEGA-Speed-Drill-Uni

Broca helicoidal de metal duro
SCD221 (8xD), suministro de refrigerante interior

Ejecución:

Diámetro de broca: 3,00 – 20,00 mm
Tolerancia del agujero: ≥ IT 9
Material de corte: HP374
Número de insertos: 2
Número de biseles guía: 3
Ángulo de la punta: 135°
Ángulo de hélice: 30°

Aplicación:

Para el mecanizado a alta velocidad.

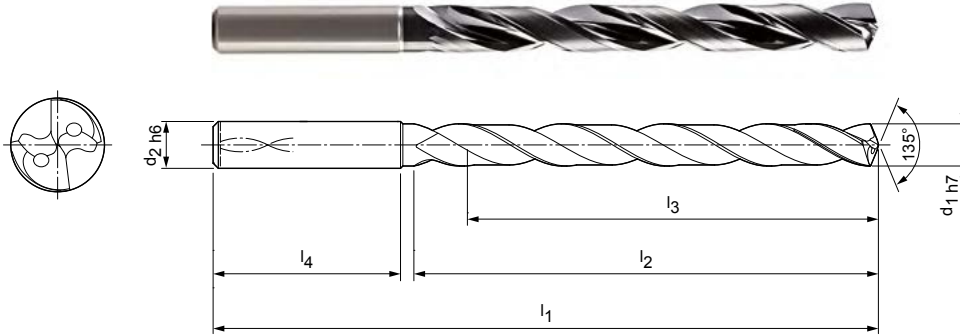

Serie preferente disponible en stock en forma de mango HA

Dimensiones						Forma del mango HA	
d ₁ h7	d ₂ h6	l ₁	l ₂	l ₃	l ₄	Especificación	Referencia
3,00	6	72	34	29	36	SCD221-0300-2-3-135HA08-HP374	30404000
3,20	6	72	34	29	36	SCD221-0320-2-3-135HA08-HP374	30404002
3,30	6	72	34	29	36	SCD221-0330-2-3-135HA08-HP374	30404003
3,40	6	72	34	29	36	SCD221-0340-2-3-135HA08-HP374	30404004
3,50	6	72	34	29	36	SCD221-0350-2-3-135HA08-HP374	30404005
3,70	6	72	34	29	36	SCD221-0370-2-3-135HA08-HP374	30404007
4,00	6	81	43	36	36	SCD221-0400-2-3-135HA08-HP374	30404010
4,10	6	81	43	36	36	SCD221-0410-2-3-135HA08-HP374	30404011
4,20	6	81	43	36	36	SCD221-0420-2-3-135HA08-HP374	30404012
4,30	6	81	43	36	36	SCD221-0430-2-3-135HA08-HP374	30404013
4,50	6	81	43	36	36	SCD221-0450-2-3-135HA08-HP374	30404015
4,80	6	95	57	48	36	SCD221-0480-2-3-135HA08-HP374	30404019
5,00	6	95	57	48	36	SCD221-0500-2-3-135HA08-HP374	30404021
5,10	6	95	57	48	36	SCD221-0510-2-3-135HA08-HP374	30404022
5,20	6	95	57	48	36	SCD221-0520-2-3-135HA08-HP374	30404023
5,40	6	95	57	48	36	SCD221-0540-2-3-135HA08-HP374	30404025
5,50	6	95	57	48	36	SCD221-0550-2-3-135HA08-HP374	30404026
5,80	6	95	57	48	36	SCD221-0580-2-3-135HA08-HP374	30404030
6,00	6	95	57	48	36	SCD221-0600-2-3-135HA08-HP374	30404032
6,10	8	114	76	64	36	SCD221-0610-2-3-135HA08-HP374	30404033
6,40	8	114	76	64	36	SCD221-0640-2-3-135HA08-HP374	30404036
6,50	8	114	76	64	36	SCD221-0650-2-3-135HA08-HP374	30404037
6,80	8	114	76	64	36	SCD221-0680-2-3-135HA08-HP374	30404040
7,00	8	114	76	64	36	SCD221-0700-2-3-135HA08-HP374	30404043
7,50	8	114	76	64	36	SCD221-0750-2-3-135HA08-HP374	30404048
7,80	8	114	76	64	36	SCD221-0780-2-3-135HA08-HP374	30404051
8,00	8	114	76	64	36	SCD221-0800-2-3-135HA08-HP374	30404053
8,50	10	142	95	80	40	SCD221-0850-2-3-135HA08-HP374	30404058
9,00	10	142	95	80	40	SCD221-0900-2-3-135HA08-HP374	30404063
9,30	10	142	95	80	40	SCD221-0930-2-3-135HA08-HP374	30404066
9,50	10	142	95	80	40	SCD221-0950-2-3-135HA08-HP374	30404068
9,60	10	142	95	80	40	SCD221-0960-2-3-135HA08-HP374	30404069
9,80	10	142	95	80	40	SCD221-0980-2-3-135HA08-HP374	30404071
10,00	10	142	95	80	40	SCD221-1000-2-3-135HA08-HP374	30404073
10,20	12	162	114	96	45	SCD221-1020-2-3-135HA08-HP374	30404075

MEGA-Speed-Drill-Uni | Broca helicoidal de metal duro SCD221 (8xD), suministro de refrigerante interior

Dimensiones						Forma del mango HA	
d ₁ h7	d ₂ h6	l ₁	l ₂	l ₃	l ₄	Especificación	Referencia
10,50	12	162	114	96	45	SCD221-1050-2-3-135HA08-HP374	30404078
11,00	12	162	114	96	45	SCD221-1100-2-3-135HA08-HP374	30404083
11,40	12	162	114	96	45	SCD221-1140-2-3-135HA08-HP374	30404088
11,80	12	162	114	96	45	SCD221-1180-2-3-135HA08-HP374	30404092
12,00	12	162	114	96	45	SCD221-1200-2-3-135HA08-HP374	30404094
12,50	14	178	133	112	45	SCD221-1250-2-3-135HA08-HP374	30404095
13,00	14	178	133	112	45	SCD221-1300-2-3-135HA08-HP374	30404097
13,50	14	178	133	112	45	SCD221-1350-2-3-135HA08-HP374	30404098
14,00	14	178	133	112	45	SCD221-1400-2-3-135HA08-HP374	30404100
15,00	16	203	152	128	48	SCD221-1500-2-3-135HA08-HP374	30404103
16,00	16	203	152	128	48	SCD221-1600-2-3-135HA08-HP374	30404106
17,50	18	222	171	144	48	SCD221-1750-2-3-135HA08-HP374	30404110

Características configurables

**Diámetro:**

Diámetro seleccionable libremente en incrementos de 0,01 mm

**Forma del mango:**

Forma del mango: HB | HE

Especificación

SCD221-[diámetro]-3-3-140[forma del mango]08-HP374

Dimensiones de la serie configurable

d ₁ min.	d ₁ max.	d ₂ h6	l ₁	l ₂	l ₃	l ₄
3,00	3,70	6	72	34	29	36
3,71	4,70	6	81	43	36	36
4,80	6,00	6	95	57	48	36
6,01	8,00	8	114	76	64	36
8,01	10,00	10	142	95	80	40
10,01	12,00	12	162	114	96	45
12,01	14,00	14	178	133	112	45
14,01	16,00	16	203	152	128	48
16,01	18,00	18	222	171	144	48
18,01	20,00	20	243	190	160	50

Ejemplo:

SCD221-0431-3-3-140HE08-HP374

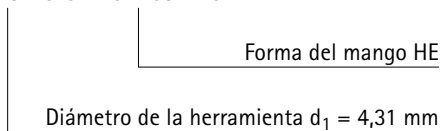

Medidas en mm.

Para la recomendación de valores de corte, véase al final del capítulo.

Ejecuciones especiales y otros recubrimientos a petición.

ECU-Drill-Uni

Broca helicoidal de metal duro
SCD351 (4xD), suministro de refrigerante interior

Ejecución:

Diámetro de broca: 3,00 - 20,00 mm
Tolerancia del agujero: ≥ IT 9
Material de corte: HP765
Número de insertos: 2
Ángulo de la punta: 140°
Ángulo de hélice: 30°

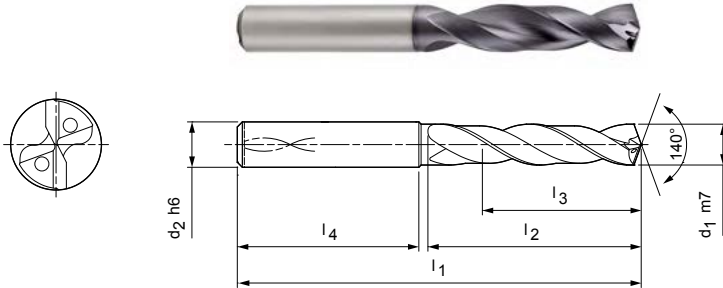

Serie preferente disponible en stock en forma de mango HA

Dimensiones						Forma del mango HA	
d ₁ m7	d ₂ h6	l ₁	l ₂	l ₃	l ₄	Especificación	Referencia
3,00	6	62	22	16	36	SCD351-0300-2-2-140HA04-HP765	30421828
3,10	6	62	22	16	36	SCD351-0310-2-2-140HA04-HP765	30421829
3,20	6	62	22	16	36	SCD351-0320-2-2-140HA04-HP765	30421830
3,30	6	62	22	16	36	SCD351-0330-2-2-140HA04-HP765	30421831
3,40	6	62	22	16	36	SCD351-0340-2-2-140HA04-HP765	30421832
3,50	6	62	22	16	36	SCD351-0350-2-2-140HA04-HP765	30421833
3,60	6	62	22	16	36	SCD351-0360-2-2-140HA04-HP765	30421834
3,70*	6	62	22	16	36	SCD351-0370-2-2-140HA04-HP765	30421835
3,80	6	66	26	22	36	SCD351-0380-2-2-140HA04-HP765	30421836
3,90	6	66	26	22	36	SCD351-0390-2-2-140HA04-HP765	30421837
4,00	6	66	26	22	36	SCD351-0400-2-2-140HA04-HP765	30421838
4,10	6	66	26	22	36	SCD351-0410-2-2-140HA04-HP765	30421839
4,20	6	66	26	22	36	SCD351-0420-2-2-140HA04-HP765	30421840
4,30	6	66	26	22	36	SCD351-0430-2-2-140HA04-HP765	30421842
4,40	6	66	26	22	36	SCD351-0440-2-2-140HA04-HP765	30421843
4,50	6	66	26	22	36	SCD351-0450-2-2-140HA04-HP765	30421844
4,60	6	66	26	22	36	SCD351-0460-2-2-140HA04-HP765	30421845
4,65*	6	66	26	22	36	SCD351-0465-2-2-140HA04-HP765	30421846
4,70	6	66	26	22	36	SCD351-0470-2-2-140HA04-HP765	30421847
4,80	6	66	30	24	36	SCD351-0480-2-2-140HA04-HP765	30421848
4,90	6	66	30	24	36	SCD351-0490-2-2-140HA04-HP765	30421849
5,00	6	66	30	24	36	SCD351-0500-2-2-140HA04-HP765	30421850
5,10	6	66	30	24	36	SCD351-0510-2-2-140HA04-HP765	30421851
5,20	6	66	30	24	36	SCD351-0520-2-2-140HA04-HP765	30421852
5,30	6	66	30	24	36	SCD351-0530-2-2-140HA04-HP765	30421853
5,40	6	66	30	24	36	SCD351-0540-2-2-140HA04-HP765	30421854
5,50	6	66	30	24	36	SCD351-0550-2-2-140HA04-HP765	30421855
5,55*	6	66	30	24	36	SCD351-0555-2-2-140HA04-HP765	30421856
5,60	6	66	30	24	36	SCD351-0560-2-2-140HA04-HP765	30421857
5,70	6	66	30	24	36	SCD351-0570-2-2-140HA04-HP765	30421858
5,80	6	66	30	24	36	SCD351-0580-2-2-140HA04-HP765	30421859
5,90	6	66	30	24	36	SCD351-0590-2-2-140HA04-HP765	30421860
6,00	6	66	30	24	36	SCD351-0600-2-2-140HA04-HP765	30421861
6,10	8	79	38	30	36	SCD351-0610-2-2-140HA04-HP765	30421862

ECU-Drill-Uni | Broca helicoidal de metal duro SCD351 (4xD), suministro de refrigerante interior

Dimensiones						Forma del mango HA	
d ₁ m7	d ₂ h6	l ₁	l ₂	l ₃	l ₄	Especificación	Referencia
6,20	8	79	38	30	36	SCD351-0620-2-2-140HA04-HP765	30421863
6,30	8	79	38	30	36	SCD351-0630-2-2-140HA04-HP765	30421864
6,40	8	79	38	30	36	SCD351-0640-2-2-140HA04-HP765	30421865
6,50	8	79	38	30	36	SCD351-0650-2-2-140HA04-HP765	30421866
6,60	8	79	38	30	36	SCD351-0660-2-2-140HA04-HP765	30421867
6,70	8	79	38	30	36	SCD351-0670-2-2-140HA04-HP765	30421868
6,80	8	79	38	30	36	SCD351-0680-2-2-140HA04-HP765	30421869
6,90	8	79	38	30	36	SCD351-0690-2-2-140HA04-HP765	30421870
7,00	8	79	38	30	36	SCD351-0700-2-2-140HA04-HP765	30421871
7,10	8	79	42	34	36	SCD351-0710-2-2-140HA04-HP765	30421872
7,20	8	79	42	34	36	SCD351-0720-2-2-140HA04-HP765	30421873
7,30	8	79	42	34	36	SCD351-0730-2-2-140HA04-HP765	30421874
7,40	8	79	42	34	36	SCD351-0740-2-2-140HA04-HP765	30421875
7,45*	8	79	42	34	36	SCD351-0745-2-2-140HA04-HP765	30569196
7,50	8	79	42	34	36	SCD351-0750-2-2-140HA04-HP765	30421876
7,60	8	79	42	34	36	SCD351-0760-2-2-140HA04-HP765	30421878
7,70	8	79	42	34	36	SCD351-0770-2-2-140HA04-HP765	30421879
7,80	8	79	42	34	36	SCD351-0780-2-2-140HA04-HP765	30421880
7,90	8	79	42	34	36	SCD351-0790-2-2-140HA04-HP765	30421881
8,00	8	79	42	34	36	SCD351-0800-2-2-140HA04-HP765	30421882
8,10	10	89	49	38	40	SCD351-0810-2-2-140HA04-HP765	30421883
8,20	10	89	49	38	40	SCD351-0820-2-2-140HA04-HP765	30421884
8,30	10	89	49	38	40	SCD351-0830-2-2-140HA04-HP765	30421885
8,40	10	89	49	38	40	SCD351-0840-2-2-140HA04-HP765	30421886
8,50	10	89	49	38	40	SCD351-0850-2-2-140HA04-HP765	30421887
8,60	10	89	49	38	40	SCD351-0860-2-2-140HA04-HP765	30421888
8,70	10	89	49	38	40	SCD351-0870-2-2-140HA04-HP765	30421889
8,80	10	89	49	38	40	SCD351-0880-2-2-140HA04-HP765	30421890
8,90	10	89	49	38	40	SCD351-0890-2-2-140HA04-HP765	30421891
9,00	10	89	49	38	40	SCD351-0900-2-2-140HA04-HP765	30421892
9,10	10	89	49	38	40	SCD351-0910-2-2-140HA04-HP765	30421893
9,20	10	89	49	38	40	SCD351-0920-2-2-140HA04-HP765	30421894
9,30*	10	89	49	40	40	SCD351-0930-2-2-140HA04-HP765	30421896
9,40	10	89	49	40	40	SCD351-0940-2-2-140HA04-HP765	30421897
9,50	10	89	49	40	40	SCD351-0950-2-2-140HA04-HP765	30421898
9,60	10	89	49	40	40	SCD351-0960-2-2-140HA04-HP765	30421899
9,70	10	89	49	40	40	SCD351-0970-2-2-140HA04-HP765	30421900
9,80	10	89	49	40	40	SCD351-0980-2-2-140HA04-HP765	30421901
9,90	10	89	49	40	40	SCD351-0990-2-2-140HA04-HP765	30421902
10,00	10	89	49	40	40	SCD351-1000-2-2-140HA04-HP765	30421903
10,10	12	102	56	45	45	SCD351-1010-2-2-140HA04-HP765	30421904
10,20	12	102	56	45	45	SCD351-1020-2-2-140HA04-HP765	30421905
10,30	12	102	56	45	45	SCD351-1030-2-2-140HA04-HP765	30421906
10,40	12	102	56	45	45	SCD351-1040-2-2-140HA04-HP765	30421907
10,50	12	102	56	45	45	SCD351-1050-2-2-140HA04-HP765	30421908
10,60	12	102	56	45	45	SCD351-1060-2-2-140HA04-HP765	30421909
10,70	12	102	56	45	45	SCD351-1070-2-2-140HA04-HP765	30421910
10,80	12	102	56	45	45	SCD351-1080-2-2-140HA04-HP765	30421911
10,90	12	102	56	45	45	SCD351-1090-2-2-140HA04-HP765	30421912
11,00	12	102	56	45	45	SCD351-1100-2-2-140HA04-HP765	30421913
11,10	12	102	56	45	45	SCD351-1110-2-2-140HA04-HP765	30421914
11,20*	12	102	56	45	45	SCD351-1120-2-2-140HA04-HP765	30421915
11,50	12	102	56	45	45	SCD351-1150-2-2-140HA04-HP765	30421918
11,70	12	102	56	45	45	SCD351-1170-2-2-140HA04-HP765	30421920
11,80	12	102	56	45	45	SCD351-1180-2-2-140HA04-HP765	30421921

Continúa en la página siguiente.

ECU-Drill-Uni | Broca helicoidal de metal duro SCD351 (4xD), suministro de refrigerante interior

Dimensiones						Forma del mango HA	
d ₁ m7	d ₂ h6	l ₁	l ₂	l ₃	l ₄	Especificación	Referencia
11,90	12	102	56	45	45	SCD351-1190-2-2-140HA04-HP765	30421922
12,00	12	102	56	45	45	SCD351-1200-2-2-140HA04-HP765	30421923
12,20	14	107	61	50	45	SCD351-1220-2-2-140HA04-HP765	30421924
12,50	14	107	61	50	45	SCD351-1250-2-2-140HA04-HP765	30421925
12,70	14	107	61	50	45	SCD351-1270-2-2-140HA04-HP765	30421926
12,80	14	107	61	50	45	SCD351-1280-2-2-140HA04-HP765	30421927
13,00	14	107	61	50	45	SCD351-1300-2-2-140HA04-HP765	30421928
13,50	14	107	61	50	45	SCD351-1350-2-2-140HA04-HP765	30421929
13,80	14	107	61	50	45	SCD351-1380-2-2-140HA04-HP765	30421931
14,00	14	107	61	50	45	SCD351-1400-2-2-140HA04-HP765	30421932
14,20	16	115	65	51	48	SCD351-1420-2-2-140HA04-HP765	30421934
14,50	16	115	65	51	48	SCD351-1450-2-2-140HA04-HP765	30421935
14,80	16	115	65	51	48	SCD351-1480-2-2-140HA04-HP765	30421936
15,00	16	115	65	51	48	SCD351-1500-2-2-140HA04-HP765	30421937
15,10	16	115	65	51	48	SCD351-1510-2-2-140HA04-HP765	30421938
15,20	16	115	65	51	48	SCD351-1520-2-2-140HA04-HP765	30421939
15,50	16	115	65	51	48	SCD351-1550-2-2-140HA04-HP765	30421941
15,70	16	115	65	51	48	SCD351-1570-2-2-140HA04-HP765	30421942
15,80	16	115	65	51	48	SCD351-1580-2-2-140HA04-HP765	30421943
16,00	16	115	65	51	48	SCD351-1600-2-2-140HA04-HP765	30421944
16,50	18	123	73	53	48	SCD351-1650-2-2-140HA04-HP765	30421946
16,80	18	123	73	53	48	SCD351-1680-2-2-140HA04-HP765	30569199
17,00	18	123	73	53	48	SCD351-1700-2-2-140HA04-HP765	30421947
17,30	18	123	73	53	48	SCD351-1730-2-2-140HA04-HP765	30421949
17,50	18	123	73	53	48	SCD351-1750-2-2-140HA04-HP765	30421950
17,70	18	123	73	53	48	SCD351-1770-2-2-140HA04-HP765	30421951
18,00	18	123	73	53	48	SCD351-1800-2-2-140HA04-HP765	30421952
18,50	20	131	79	55	50	SCD351-1850-2-2-140HA04-HP765	30421953
19,00	20	131	79	55	50	SCD351-1900-2-2-140HA04-HP765	30421954
19,50	20	131	79	55	50	SCD351-1950-2-2-140HA04-HP765	30421956
20,00	20	131	79	55	50	SCD351-2000-2-2-140HA04-HP765	30421957

Características configurables



Forma del mango:
Forma del mango: HB | HE



Especificación
SCD351-0430-3-3-140[forma del mango]04-HP765

Ejemplo:
SCD351-0430-3-3-140HE04-HP765

Forma del mango HE

Medidas en mm.

* Especialmente indicada para la prefabricación de los agujeros para rosca para machos de laminación.

Para la recomendación de valores de corte, véase al final del capítulo.

Ejecuciones especiales y otros recubrimientos a petición.

ECU-Drill-Uni

Broca helicoidal de metal duro
SCD350 (4xD), suministro de refrigerante exterior

Ejecución:
 Diámetro de broca: 3,00 - 20,00 mm
 Tolerancia del agujero: ≥ IT 9
 Material de corte: HP765
 Número de insertos: 2
 Ángulo de la punta: 140°
 Ángulo de hélice: 30°

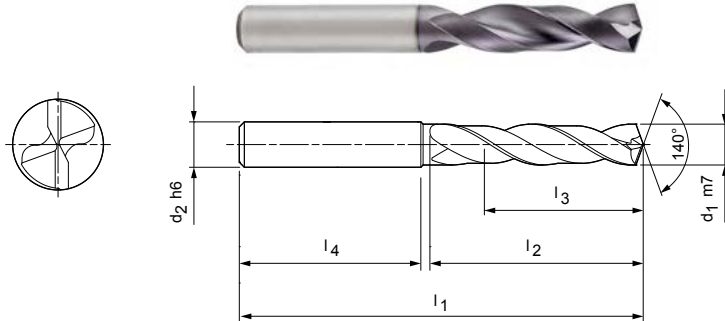

Serie preferente disponible en stock en forma de mango HA

Dimensiones						Forma del mango HA	
d ₁ m7	d ₂ h6	l ₁	l ₂	l ₃	l ₄	Especificación	Referencia
3,00	6	62	22	16	36	SCD350-0300-2-2-140HA04-HP765	30421694
3,10	6	62	22	16	36	SCD350-0310-2-2-140HA04-HP765	30421696
3,20	6	62	22	16	36	SCD350-0320-2-2-140HA04-HP765	30421697
3,30	6	62	22	16	36	SCD350-0330-2-2-140HA04-HP765	30421698
3,40	6	62	22	16	36	SCD350-0340-2-2-140HA04-HP765	30421699
3,50	6	62	22	16	36	SCD350-0350-2-2-140HA04-HP765	30421700
3,60	6	62	22	16	36	SCD350-0360-2-2-140HA04-HP765	30421701
3,70*	6	62	22	16	36	SCD350-0370-2-2-140HA04-HP765	30421703
3,80	6	66	26	22	36	SCD350-0380-2-2-140HA04-HP765	30421704
3,90	6	66	26	22	36	SCD350-0390-2-2-140HA04-HP765	30421705
4,00	6	66	26	22	36	SCD350-0400-2-2-140HA04-HP765	30421706
4,10	6	66	26	22	36	SCD350-0410-2-2-140HA04-HP765	30421707
4,20	6	66	26	22	36	SCD350-0420-2-2-140HA04-HP765	30421708
4,30	6	66	26	22	36	SCD350-0430-2-2-140HA04-HP765	30421709
4,40	6	66	26	22	36	SCD350-0440-2-2-140HA04-HP765	30421710
4,50	6	66	26	22	36	SCD350-0450-2-2-140HA04-HP765	30421711
4,60	6	66	26	22	36	SCD350-0460-2-2-140HA04-HP765	30421712
4,65*	6	66	26	22	36	SCD350-0465-2-2-140HA04-HP765	30421713
4,70	6	66	26	22	36	SCD350-0470-2-2-140HA04-HP765	30421714
4,80	6	66	30	24	36	SCD350-0480-2-2-140HA04-HP765	30421715
4,90	6	66	30	24	36	SCD350-0490-2-2-140HA04-HP765	30421716
5,00	6	66	30	24	36	SCD350-0500-2-2-140HA04-HP765	30421717
5,10	6	66	30	24	36	SCD350-0510-2-2-140HA04-HP765	30421718
5,20	6	66	30	24	36	SCD350-0520-2-2-140HA04-HP765	30421719
5,30	6	66	30	24	36	SCD350-0530-2-2-140HA04-HP765	30421720
5,40	6	66	30	24	36	SCD350-0540-2-2-140HA04-HP765	30421721
5,50	6	66	30	24	36	SCD350-0550-2-2-140HA04-HP765	30421722
5,55*	6	66	30	24	36	SCD350-0555-2-2-140HA04-HP765	30421723
5,60	6	66	30	24	36	SCD350-0560-2-2-140HA04-HP765	30421725
5,70	6	66	30	24	36	SCD350-0570-2-2-140HA04-HP765	30421726
5,80	6	66	30	24	36	SCD350-0580-2-2-140HA04-HP765	30421727
5,90	6	66	30	24	36	SCD350-0590-2-2-140HA04-HP765	30421728
6,00	6	66	30	24	36	SCD350-0600-2-2-140HA04-HP765	30421731
6,10	8	79	38	30	36	SCD350-0610-2-2-140HA04-HP765	30421732

ECU-Drill-Uni | Broca helicoidal de metal duro SCD350 (4xD), suministro de refrigerante exterior

Dimensiones						Forma del mango HA	
d ₁ m7	d ₂ h6	l ₁	l ₂	l ₃	l ₄	Especificación	Referencia
6,20	8	79	38	30	36	SCD350-0620-2-2-140HA04-HP765	30421733
6,30	8	79	38	30	36	SCD350-0630-2-2-140HA04-HP765	30421734
6,40	8	79	38	30	36	SCD350-0640-2-2-140HA04-HP765	30421735
6,50	8	79	38	30	36	SCD350-0650-2-2-140HA04-HP765	30421736
6,60	8	79	38	30	36	SCD350-0660-2-2-140HA04-HP765	30421737
6,70	8	79	38	30	36	SCD350-0670-2-2-140HA04-HP765	30421738
6,80	8	79	38	30	36	SCD350-0680-2-2-140HA04-HP765	30421739
6,90	8	79	38	30	36	SCD350-0690-2-2-140HA04-HP765	30421740
7,00	8	79	38	30	36	SCD350-0700-2-2-140HA04-HP765	30421741
7,10	8	79	42	34	36	SCD350-0710-2-2-140HA04-HP765	30421742
7,20	8	79	42	34	36	SCD350-0720-2-2-140HA04-HP765	30421743
7,30	8	79	42	34	36	SCD350-0730-2-2-140HA04-HP765	30421744
7,40	8	79	42	34	36	SCD350-0740-2-2-140HA04-HP765	30421745
7,50	8	79	42	34	36	SCD350-0750-2-2-140HA04-HP765	30421746
7,60	8	79	42	34	36	SCD350-0760-2-2-140HA04-HP765	30421748
7,70	8	79	42	34	36	SCD350-0770-2-2-140HA04-HP765	30421749
7,80	8	79	42	34	36	SCD350-0780-2-2-140HA04-HP765	30421750
7,90	8	79	42	34	36	SCD350-0790-2-2-140HA04-HP765	30421751
8,00	8	79	42	34	36	SCD350-0800-2-2-140HA04-HP765	30421752
8,10	10	89	49	38	40	SCD350-0810-2-2-140HA04-HP765	30421753
8,20	10	89	49	38	40	SCD350-0820-2-2-140HA04-HP765	30421754
8,30	10	89	49	38	40	SCD350-0830-2-2-140HA04-HP765	30421755
8,40	10	89	49	38	40	SCD350-0840-2-2-140HA04-HP765	30421756
8,50	10	89	49	38	40	SCD350-0850-2-2-140HA04-HP765	30421757
8,60	10	89	49	38	40	SCD350-0860-2-2-140HA04-HP765	30421758
8,70	10	89	49	38	40	SCD350-0870-2-2-140HA04-HP765	30421759
8,80	10	89	49	38	40	SCD350-0880-2-2-140HA04-HP765	30421760
8,90	10	89	49	38	40	SCD350-0890-2-2-140HA04-HP765	30421761
9,00	10	89	49	38	40	SCD350-0900-2-2-140HA04-HP765	30421762
9,10	10	89	49	38	40	SCD350-0910-2-2-140HA04-HP765	30421763
9,20	10	89	49	38	40	SCD350-0920-2-2-140HA04-HP765	30421764
9,30*	10	89	49	40	40	SCD350-0930-2-2-140HA04-HP765	30421766
9,40	10	89	49	40	40	SCD350-0940-2-2-140HA04-HP765	30421767
9,50	10	89	49	40	40	SCD350-0950-2-2-140HA04-HP765	30421768
9,60	10	89	49	40	40	SCD350-0960-2-2-140HA04-HP765	30421769
9,70	10	89	49	40	40	SCD350-0970-2-2-140HA04-HP765	30421770
9,80	10	89	49	40	40	SCD350-0980-2-2-140HA04-HP765	30421771
9,90	10	89	49	40	40	SCD350-0990-2-2-140HA04-HP765	30421772
10,00	10	89	49	40	40	SCD350-1000-2-2-140HA04-HP765	30421773
10,10	12	102	56	45	45	SCD350-1010-2-2-140HA04-HP765	30421774
10,20	12	102	56	45	45	SCD350-1020-2-2-140HA04-HP765	30421775
10,30	12	102	56	45	45	SCD350-1030-2-2-140HA04-HP765	30421776
10,40	12	102	56	45	45	SCD350-1040-2-2-140HA04-HP765	30421777
10,50	12	102	56	45	45	SCD350-1050-2-2-140HA04-HP765	30421778
10,60	12	102	56	45	45	SCD350-1060-2-2-140HA04-HP765	30421779
10,80	12	102	56	45	45	SCD350-1080-2-2-140HA04-HP765	30421781
10,90	12	102	56	45	45	SCD350-1090-2-2-140HA04-HP765	30421782
11,00	12	102	56	45	45	SCD350-1100-2-2-140HA04-HP765	30421783
11,10	12	102	56	45	45	SCD350-1110-2-2-140HA04-HP765	30421784
11,20*	12	102	56	45	45	SCD350-1120-2-2-140HA04-HP765	30421785
11,30	12	102	56	45	45	SCD350-1130-2-2-140HA04-HP765	30421786
11,40	12	102	56	45	45	SCD350-1140-2-2-140HA04-HP765	30421787
11,50	12	102	56	45	45	SCD350-1150-2-2-140HA04-HP765	30421788
11,60	12	102	56	45	45	SCD350-1160-2-2-140HA04-HP765	30421789
11,70	12	102	56	45	45	SCD350-1170-2-2-140HA04-HP765	30421790

ECU-Drill-Uni | Broca helicoidal de metal duro SCD350 (4xD), suministro de refrigerante exterior

Dimensiones						Forma del mango HA	
d ₁ m7	d ₂ h6	l ₁	l ₂	l ₃	l ₄	Especificación	Referencia
11,80	12	102	56	45	45	SCD350-1180-2-2-140HA04-HP765	30421791
12,00	12	102	56	45	45	SCD350-1200-2-2-140HA04-HP765	30421793
12,20	14	107	61	50	45	SCD350-1220-2-2-140HA04-HP765	30421794
12,50	14	107	61	50	45	SCD350-1250-2-2-140HA04-HP765	30421795
12,80	14	107	61	50	45	SCD350-1280-2-2-140HA04-HP765	30421798
13,00	14	107	61	50	45	SCD350-1300-2-2-140HA04-HP765	30421799
13,50	14	107	61	50	45	SCD350-1350-2-2-140HA04-HP765	30421800
13,80	14	107	61	50	45	SCD350-1380-2-2-140HA04-HP765	30421802
14,00	14	107	61	50	45	SCD350-1400-2-2-140HA04-HP765	30421803
14,20	16	115	65	51	48	SCD350-1420-2-2-140HA04-HP765	30421804
14,50	16	115	65	51	48	SCD350-1450-2-2-140HA04-HP765	30421805
14,80	16	115	65	51	48	SCD350-1480-2-2-140HA04-HP765	30421807
15,00	16	115	65	51	48	SCD350-1500-2-2-140HA04-HP765	30421808
15,10	16	115	65	51	48	SCD350-1510-2-2-140HA04-HP765	30421809
15,20	16	115	65	51	48	SCD350-1520-2-2-140HA04-HP765	30421810
15,50	16	115	65	51	48	SCD350-1550-2-2-140HA04-HP765	30421811
15,70	16	115	65	51	48	SCD350-1570-2-2-140HA04-HP765	30421813
15,80	16	115	65	51	48	SCD350-1580-2-2-140HA04-HP765	30421814
16,00	16	115	65	51	48	SCD350-1600-2-2-140HA04-HP765	30421815
16,50	18	123	73	53	48	SCD350-1650-2-2-140HA04-HP765	30421817
17,00	18	123	73	53	48	SCD350-1700-2-2-140HA04-HP765	30421818
17,50	18	123	73	53	48	SCD350-1750-2-2-140HA04-HP765	30421820
17,70	18	123	73	53	48	SCD350-1770-2-2-140HA04-HP765	30421821
18,00	18	123	73	53	48	SCD350-1800-2-2-140HA04-HP765	30421822
18,50	20	131	79	55	50	SCD350-1850-2-2-140HA04-HP765	30421823
19,00	20	131	79	55	50	SCD350-1900-2-2-140HA04-HP765	30421824
19,50	20	131	79	55	50	SCD350-1950-2-2-140HA04-HP765	30421826
20,00	20	131	79	55	50	SCD350-2000-2-2-140HA04-HP765	30421827

Características configurables



Forma del mango:
Forma del mango: HB | HE



Especificación
SCD350-0430-3-3-140[forma del mango]04-HP765

Ejemplo:
SCD350-0430-3-3-140HE04-HP765

Forma del mango HE

Medidas en mm.

* Especialmente indicada para la prefabricación de los agujeros para rosca para machos de laminación.

Para la recomendación de valores de corte, véase al final del capítulo.

Ejecuciones especiales y otros recubrimientos a petición.

ECU-Drill-Uni

Broca helicoidal de metal duro
SCD351 (6xD), suministro de refrigerante interior

Ejecución:
 Diámetro de broca: 3,00 - 20,00 mm
 Tolerancia del agujero: ≥ IT 9
 Material de corte: HP765
 Número de insertos: 2
 Ángulo de la punta: 140°
 Ángulo de hélice: 30°

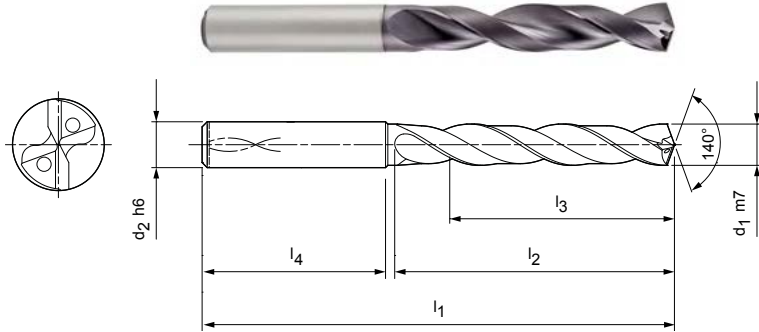

Serie preferente disponible en stock en forma de mango HA

Dimensiones						Forma del mango HA	
d ₁ m7	d ₂ h6	l ₁	l ₂	l ₃	l ₄	Especificación	Referencia
3,00	6	66	28	23	36	SCD351-0300-2-2-140HA06-HP765	30421958
3,10	6	66	28	23	36	SCD351-0310-2-2-140HA06-HP765	30421959
3,20	6	66	28	23	36	SCD351-0320-2-2-140HA06-HP765	30421960
3,30	6	66	28	23	36	SCD351-0330-2-2-140HA06-HP765	30421961
3,40	6	66	28	23	36	SCD351-0340-2-2-140HA06-HP765	30421962
3,50	6	66	28	23	36	SCD351-0350-2-2-140HA06-HP765	30421963
3,60	6	66	28	23	36	SCD351-0360-2-2-140HA06-HP765	30421964
3,70*	6	66	28	23	36	SCD351-0370-2-2-140HA06-HP765	30421965
3,80	6	74	36	29	36	SCD351-0380-2-2-140HA06-HP765	30421966
3,90	6	74	36	29	36	SCD351-0390-2-2-140HA06-HP765	30421967
4,00	6	74	36	29	36	SCD351-0400-2-2-140HA06-HP765	30421968
4,10	6	74	36	29	36	SCD351-0410-2-2-140HA06-HP765	30421969
4,20	6	74	36	29	36	SCD351-0420-2-2-140HA06-HP765	30421970
4,30	6	74	36	29	36	SCD351-0430-2-2-140HA06-HP765	30421971
4,40	6	74	36	29	36	SCD351-0440-2-2-140HA06-HP765	30421972
4,50	6	74	36	29	36	SCD351-0450-2-2-140HA06-HP765	30421973
4,60	6	74	36	29	36	SCD351-0460-2-2-140HA06-HP765	30421974
4,65*	6	74	36	29	36	SCD351-0465-2-2-140HA06-HP765	30421975
4,70	6	74	36	29	36	SCD351-0470-2-2-140HA06-HP765	30421976
4,80	6	82	44	35	36	SCD351-0480-2-2-140HA06-HP765	30421977
4,90	6	82	44	35	36	SCD351-0490-2-2-140HA06-HP765	30421978
5,00	6	82	44	35	36	SCD351-0500-2-2-140HA06-HP765	30421979
5,10	6	82	44	35	36	SCD351-0510-2-2-140HA06-HP765	30421980
5,20	6	82	44	35	36	SCD351-0520-2-2-140HA06-HP765	30421981
5,30	6	82	44	35	36	SCD351-0530-2-2-140HA06-HP765	30421982
5,40	6	82	44	35	36	SCD351-0540-2-2-140HA06-HP765	30421983
5,50	6	82	44	35	36	SCD351-0550-2-2-140HA06-HP765	30421984
5,55*	6	82	44	35	36	SCD351-0555-2-2-140HA06-HP765	30421985
5,60	6	82	44	35	36	SCD351-0560-2-2-140HA06-HP765	30421987
5,70	6	82	44	35	36	SCD351-0570-2-2-140HA06-HP765	30421988
5,80	6	82	44	35	36	SCD351-0580-2-2-140HA06-HP765	30421989
5,90	6	82	44	35	36	SCD351-0590-2-2-140HA06-HP765	30421990
6,00	6	82	44	35	36	SCD351-0600-2-2-140HA06-HP765	30421991
6,10	8	91	53	43	36	SCD351-0610-2-2-140HA06-HP765	30421992
6,20	8	91	53	43	36	SCD351-0620-2-2-140HA06-HP765	30421993

ECU-Drill-Uni | Broca helicoidal de metal duro SCD351 (6xD), suministro de refrigerante interior

Dimensiones						Forma del mango HA	
d ₁ m7	d ₂ h6	l ₁	l ₂	l ₃	l ₄	Especificación	Referencia
6,30	8	91	53	43	36	SCD351-0630-2-2-140HA06-HP765	30421994
6,40	8	91	53	43	36	SCD351-0640-2-2-140HA06-HP765	30421995
6,50	8	91	53	43	36	SCD351-0650-2-2-140HA06-HP765	30421996
6,60	8	91	53	43	36	SCD351-0660-2-2-140HA06-HP765	30421997
6,70	8	91	53	43	36	SCD351-0670-2-2-140HA06-HP765	30421998
6,80	8	91	53	43	36	SCD351-0680-2-2-140HA06-HP765	30421999
6,90	8	91	53	43	36	SCD351-0690-2-2-140HA06-HP765	30422000
7,00	8	91	53	43	36	SCD351-0700-2-2-140HA06-HP765	30422001
7,10	8	91	53	43	36	SCD351-0710-2-2-140HA06-HP765	30422002
7,20	8	91	53	43	36	SCD351-0720-2-2-140HA06-HP765	30422003
7,30	8	91	53	43	36	SCD351-0730-2-2-140HA06-HP765	30422004
7,40	8	91	53	43	36	SCD351-0740-2-2-140HA06-HP765	30422005
7,45*	8	91	53	43	36	SCD351-0745-2-2-140HA06-HP765	30569230
7,50	8	91	53	43	36	SCD351-0750-2-2-140HA06-HP765	30422006
7,60	8	91	53	43	36	SCD351-0760-2-2-140HA06-HP765	30422008
7,70	8	91	53	43	36	SCD351-0770-2-2-140HA06-HP765	30422009
7,80	8	91	53	43	36	SCD351-0780-2-2-140HA06-HP765	30422010
7,90	8	91	53	43	36	SCD351-0790-2-2-140HA06-HP765	30422011
8,00	8	91	53	43	36	SCD351-0800-2-2-140HA06-HP765	30422012
8,10	10	103	61	49	40	SCD351-0810-2-2-140HA06-HP765	30422013
8,20	10	103	61	49	40	SCD351-0820-2-2-140HA06-HP765	30422014
8,30	10	103	61	49	40	SCD351-0830-2-2-140HA06-HP765	30422015
8,40	10	103	61	49	40	SCD351-0840-2-2-140HA06-HP765	30422016
8,50	10	103	61	49	40	SCD351-0850-2-2-140HA06-HP765	30422017
8,60	10	103	61	49	40	SCD351-0860-2-2-140HA06-HP765	30422018
8,70	10	103	61	49	40	SCD351-0870-2-2-140HA06-HP765	30422019
8,80	10	103	61	49	40	SCD351-0880-2-2-140HA06-HP765	30422020
8,90	10	103	61	49	40	SCD351-0890-2-2-140HA06-HP765	30422021
9,00	10	103	61	49	40	SCD351-0900-2-2-140HA06-HP765	30422022
9,10	10	103	61	49	40	SCD351-0910-2-2-140HA06-HP765	30422023
9,20	10	103	61	49	40	SCD351-0920-2-2-140HA06-HP765	30422024
9,30*	10	103	61	49	40	SCD351-0930-2-2-140HA06-HP765	30422026
9,40	10	103	61	49	40	SCD351-0940-2-2-140HA06-HP765	30422027
9,50	10	103	61	49	40	SCD351-0950-2-2-140HA06-HP765	30422028
9,60	10	103	61	49	40	SCD351-0960-2-2-140HA06-HP765	30422029
9,70	10	103	61	49	40	SCD351-0970-2-2-140HA06-HP765	30422030
9,80	10	103	61	49	40	SCD351-0980-2-2-140HA06-HP765	30422031
9,90	10	103	61	49	40	SCD351-0990-2-2-140HA06-HP765	30422032
10,00	10	103	61	49	40	SCD351-1000-2-2-140HA06-HP765	30422033
10,10	12	118	71	56	45	SCD351-1010-2-2-140HA06-HP765	30422034
10,20	12	118	71	56	45	SCD351-1020-2-2-140HA06-HP765	30422035
10,30	12	118	71	56	45	SCD351-1030-2-2-140HA06-HP765	30422036
10,40	12	118	71	56	45	SCD351-1040-2-2-140HA06-HP765	30422037
10,50	12	118	71	56	45	SCD351-1050-2-2-140HA06-HP765	30422038
10,60	12	118	71	56	45	SCD351-1060-2-2-140HA06-HP765	30422039
10,70	12	118	71	56	45	SCD351-1070-2-2-140HA06-HP765	30422040
10,80	12	118	71	56	45	SCD351-1080-2-2-140HA06-HP765	30422041
10,90	12	118	71	56	45	SCD351-1090-2-2-140HA06-HP765	30422042
11,00	12	118	71	56	45	SCD351-1100-2-2-140HA06-HP765	30422043
11,10	12	118	71	56	45	SCD351-1110-2-2-140HA06-HP765	30422044
11,20*	12	118	71	56	45	SCD351-1120-2-2-140HA06-HP765	30422045
11,30	12	118	71	56	45	SCD351-1130-2-2-140HA06-HP765	30422046
11,50	12	118	71	56	45	SCD351-1150-2-2-140HA06-HP765	30422048
11,60	12	118	71	56	45	SCD351-1160-2-2-140HA06-HP765	30422049
11,80	12	118	71	56	45	SCD351-1180-2-2-140HA06-HP765	30422051
11,90	12	118	71	56	45	SCD351-1190-2-2-140HA06-HP765	30422052
12,00	12	118	71	56	45	SCD351-1200-2-2-140HA06-HP765	30422053

Continúa en la página siguiente.

ECU-Drill-Uni | Broca helicoidal de metal duro SCD351 (6xD), suministro de refrigerante interior

Dimensiones						Forma del mango HA	
d ₁ m7	d ₂ h6	l ₁	l ₂	l ₃	l ₄	Especificación	Referencia
12,20	14	124	77	60	45	SCD351-1220-2-2-140HA06-HP765	30422054
12,50	14	124	77	60	45	SCD351-1250-2-2-140HA06-HP765	30422055
12,70	14	124	77	60	45	SCD351-1270-2-2-140HA06-HP765	30422056
12,80	14	124	77	60	45	SCD351-1280-2-2-140HA06-HP765	30422057
13,00	14	124	77	60	45	SCD351-1300-2-2-140HA06-HP765	30422058
13,50	14	124	77	60	45	SCD351-1350-2-2-140HA06-HP765	30422059
13,70	14	124	77	60	45	SCD351-1370-2-2-140HA06-HP765	30422060
13,80	14	124	77	60	45	SCD351-1380-2-2-140HA06-HP765	30422061
14,00	14	124	77	60	45	SCD351-1400-2-2-140HA06-HP765	30422062
14,20	16	133	83	63	48	SCD351-1420-2-2-140HA06-HP765	30422063
14,50	16	133	83	63	48	SCD351-1450-2-2-140HA06-HP765	30422064
14,80	16	133	83	63	48	SCD351-1480-2-2-140HA06-HP765	30422066
15,00	16	133	83	63	48	SCD351-1500-2-2-140HA06-HP765	30422067
15,50	16	133	83	63	48	SCD351-1550-2-2-140HA06-HP765	30422069
15,70	16	133	83	63	48	SCD351-1570-2-2-140HA06-HP765	30422070
15,80	16	133	83	63	48	SCD351-1580-2-2-140HA06-HP765	30422071
16,00	16	133	83	63	48	SCD351-1600-2-2-140HA06-HP765	30422072
16,50	18	143	93	71	48	SCD351-1650-2-2-140HA06-HP765	30422073
17,00	18	143	93	71	48	SCD351-1700-2-2-140HA06-HP765	30422074
17,50	18	143	93	71	48	SCD351-1750-2-2-140HA06-HP765	30422075
18,00	18	143	93	71	48	SCD351-1800-2-2-140HA06-HP765	30422076
18,50	20	153	101	77	50	SCD351-1850-2-2-140HA06-HP765	30422077
19,00	20	153	101	77	50	SCD351-1900-2-2-140HA06-HP765	30422078
19,50	20	153	101	77	50	SCD351-1950-2-2-140HA06-HP765	30422079
20,00	20	153	101	77	50	SCD351-2000-2-2-140HA06-HP765	30422080

Características configurables



Forma del mango:
Forma del mango: HB | HE



Especificación
SCD351-0430-3-3-140[forma del mango]06-HP765

Ejemplo:
SCD351-0430-3-3-140HE06-HP765

Forma del mango HE

Medidas en mm.

* Especialmente indicada para la prefabricación de los agujeros para rosca para machos de laminación.

Para la recomendación de valores de corte, véase al final del capítulo.

Ejecuciones especiales y otros recubrimientos a petición.

MEGA-Drill-Steel-Plus

Broca helicoidal de metal duro

SCD600 (3xD), suministro de refrigerante exterior, producto sucesor de la MEGA-Speed-Drill-Steel (SCD10)

Ejecución:

Diámetro de broca:	3,00 – 25,00 mm
Tolerancia del agujero:	≥ IT 9
Material de corte:	HP358
Número de insertos:	2
Número de biseles guía:	2
Ángulo de la punta:	140°
Ángulo de hélice:	30°

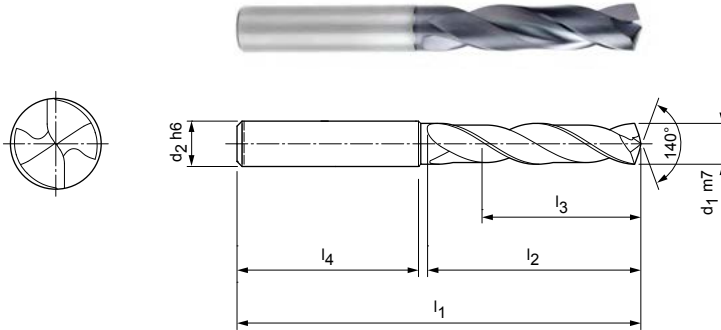

Serie preferente disponible en stock en forma de mango HA

Dimensiones						Forma del mango HA	
d ₁ m7	d ₂ h6	l ₁	l ₂	l ₃	l ₄	Especificación	Referencia
3,00	6	62	20	14	36	SCD600-0300-2-2-140HA03-HP358	30801131
3,10	6	62	20	14	36	SCD600-0310-2-2-140HA03-HP358	30801132
3,15	6	62	20	14	36	SCD600-0315-2-2-140HA03-HP358	30801133
3,20	6	62	20	14	36	SCD600-0320-2-2-140HA03-HP358	30801134
3,25	6	62	20	14	36	SCD600-0325-2-2-140HA03-HP358	30801136
3,30	6	62	20	14	36	SCD600-0330-2-2-140HA03-HP358	30801137
3,40	6	62	20	14	36	SCD600-0340-2-2-140HA03-HP358	30801138
3,50	6	62	20	14	36	SCD600-0350-2-2-140HA03-HP358	30801139
3,60	6	62	20	14	36	SCD600-0360-2-2-140HA03-HP358	30801140
3,70*	6	62	20	14	36	SCD600-0370-2-2-140HA03-HP358	30801141
3,80	6	66	24	17	36	SCD600-0380-2-2-140HA03-HP358	30801142
3,85	6	66	24	17	36	SCD600-0385-2-2-140HA03-HP358	30801143
3,90	6	66	24	17	36	SCD600-0390-2-2-140HA03-HP358	30801144
4,00	6	66	24	17	36	SCD600-0400-2-2-140HA03-HP358	30801145
4,10	6	66	24	17	36	SCD600-0410-2-2-140HA03-HP358	30801146
4,20	6	66	24	17	36	SCD600-0420-2-2-140HA03-HP358	30801147
4,25	6	66	24	17	36	SCD600-0425-2-2-140HA03-HP358	30801148
4,30	6	66	24	17	36	SCD600-0430-2-2-140HA03-HP358	30801149
4,35	6	66	24	17	36	SCD600-0435-2-2-140HA03-HP358	30801150
4,40	6	66	24	17	36	SCD600-0440-2-2-140HA03-HP358	30801151
4,45	6	66	24	17	36	SCD600-0445-2-2-140HA03-HP358	30801152
4,50	6	66	24	17	36	SCD600-0450-2-2-140HA03-HP358	30801153
4,60	6	66	24	17	36	SCD600-0460-2-2-140HA03-HP358	30801154
4,65*	6	66	24	17	36	SCD600-0465-2-2-140HA03-HP358	30801155
4,70	6	66	24	17	36	SCD600-0470-2-2-140HA03-HP358	30801156
4,80	6	66	28	20	36	SCD600-0480-2-2-140HA03-HP358	30801157
4,90	6	66	28	20	36	SCD600-0490-2-2-140HA03-HP358	30801158
4,95	6	66	28	20	36	SCD600-0495-2-2-140HA03-HP358	30801159
5,00	6	66	28	20	36	SCD600-0500-2-2-140HA03-HP358	30801160
5,05	6	66	28	20	36	SCD600-0505-2-2-140HA03-HP358	30801161
5,10	6	66	28	20	36	SCD600-0510-2-2-140HA03-HP358	30801162
5,20	6	66	28	20	36	SCD600-0520-2-2-140HA03-HP358	30801163
5,30	6	66	28	20	36	SCD600-0530-2-2-140HA03-HP358	30801164
5,40	6	66	28	20	36	SCD600-0540-2-2-140HA03-HP358	30801165
5,50	6	66	28	20	36	SCD600-0550-2-2-140HA03-HP358	30801166

Continúa en la página siguiente.

MEGA-Drill-Steel-Plus | Broca helicoidal de metal duro SCD600 (3xD), suministro de refrigerante exterior

Dimensiones						Forma del mango HA	
d ₁ m7	d ₂ h6	l ₁	l ₂	l ₃	l ₄	Especificación	Referencia
5,55*	6	66	28	20	36	SCD600-0555-2-2-140HA03-HP358	30801167
5,60	6	66	28	20	36	SCD600-0560-2-2-140HA03-HP358	30801168
5,70	6	66	28	20	36	SCD600-0570-2-2-140HA03-HP358	30801169
5,75	6	66	28	20	36	SCD600-0575-2-2-140HA03-HP358	30801170
5,80	6	66	28	20	36	SCD600-0580-2-2-140HA03-HP358	30801171
5,90	6	66	28	20	36	SCD600-0590-2-2-140HA03-HP358	30801172
5,95	6	66	28	20	36	SCD600-0595-2-2-140HA03-HP358	30801173
6,00	6	66	28	20	36	SCD600-0600-2-2-140HA03-HP358	30801174
6,10	8	79	34	24	36	SCD600-0610-2-2-140HA03-HP358	30801175
6,20	8	79	34	24	36	SCD600-0620-2-2-140HA03-HP358	30801176
6,30	8	79	34	24	36	SCD600-0630-2-2-140HA03-HP358	30801177
6,40	8	79	34	24	36	SCD600-0640-2-2-140HA03-HP358	30801178
6,50	8	79	34	24	36	SCD600-0650-2-2-140HA03-HP358	30801179
6,60	8	79	34	24	36	SCD600-0660-2-2-140HA03-HP358	30801180
6,70	8	79	34	24	36	SCD600-0670-2-2-140HA03-HP358	30801181
6,80	8	79	34	24	36	SCD600-0680-2-2-140HA03-HP358	30801182
6,90	8	79	34	24	36	SCD600-0690-2-2-140HA03-HP358	30801183
7,00	8	79	34	24	36	SCD600-0700-2-2-140HA03-HP358	30801184
7,10	8	79	41	29	36	SCD600-0710-2-2-140HA03-HP358	30801185
7,20	8	79	41	29	36	SCD600-0720-2-2-140HA03-HP358	30801186
7,30	8	79	41	29	36	SCD600-0730-2-2-140HA03-HP358	30801187
7,40	8	79	41	29	36	SCD600-0740-2-2-140HA03-HP358	30801188
7,45*	8	79	41	29	36	SCD600-0745-2-2-140HA03-HP358	30801189
7,50	8	79	41	29	36	SCD600-0750-2-2-140HA03-HP358	30801190
7,60	8	79	41	29	36	SCD600-0760-2-2-140HA03-HP358	30801191
7,70	8	79	41	29	36	SCD600-0770-2-2-140HA03-HP358	30801192
7,80	8	79	41	29	36	SCD600-0780-2-2-140HA03-HP358	30801193
7,90	8	79	41	29	36	SCD600-0790-2-2-140HA03-HP358	30801194
8,00	8	79	41	29	36	SCD600-0800-2-2-140HA03-HP358	30801195
8,10	10	89	47	35	40	SCD600-0810-2-2-140HA03-HP358	30801196
8,20	10	89	47	35	40	SCD600-0820-2-2-140HA03-HP358	30801197
9,10	10	89	47	35	40	SCD600-0910-2-2-140HA03-HP358	30801206
9,20	10	89	47	35	40	SCD600-0920-2-2-140HA03-HP358	30801207
9,30*	10	89	47	35	40	SCD600-0930-2-2-140HA03-HP358	30801208
9,35	10	89	47	35	40	SCD600-0935-2-2-140HA03-HP358	30801209
9,50	10	89	47	35	40	SCD600-0950-2-2-140HA03-HP358	30801212
9,60	10	89	47	35	40	SCD600-0960-2-2-140HA03-HP358	30801213
9,70	10	89	47	35	40	SCD600-0970-2-2-140HA03-HP358	30801214
9,80	10	89	47	35	40	SCD600-0980-2-2-140HA03-HP358	30801215
9,90	10	89	47	35	40	SCD600-0990-2-2-140HA03-HP358	30801216
10,00	10	89	47	35	40	SCD600-1000-2-2-140HA03-HP358	30801217
10,10	12	102	55	40	45	SCD600-1010-2-2-140HA03-HP358	30801218
10,20	12	102	55	40	45	SCD600-1020-2-2-140HA03-HP358	30801219
10,30	12	102	55	40	45	SCD600-1030-2-2-140HA03-HP358	30801220
10,40	12	102	55	40	45	SCD600-1040-2-2-140HA03-HP358	30801221
10,50	12	102	55	40	45	SCD600-1050-2-2-140HA03-HP358	30801222
10,55	12	102	55	40	45	SCD600-1055-2-2-140HA03-HP358	30801223
10,60	12	102	55	40	45	SCD600-1060-2-2-140HA03-HP358	30801224
10,70	12	102	55	40	45	SCD600-1070-2-2-140HA03-HP358	30801225
10,80	12	102	55	40	45	SCD600-1080-2-2-140HA03-HP358	30801227
10,90	12	102	55	40	45	SCD600-1090-2-2-140HA03-HP358	30801228
11,00	12	102	55	40	45	SCD600-1100-2-2-140HA03-HP358	30801229
11,10	12	102	55	40	45	SCD600-1110-2-2-140HA03-HP358	30801230
11,20*	12	102	55	40	45	SCD600-1120-2-2-140HA03-HP358	30801231
11,25	12	102	55	40	45	SCD600-1125-2-2-140HA03-HP358	30801232
11,30	12	102	55	40	45	SCD600-1130-2-2-140HA03-HP358	30801233
11,35	12	102	55	40	45	SCD600-1135-2-2-140HA03-HP358	30801234

MEGA-Drill-Steel-Plus | Broca helicoidal de metal duro SCD600 (3xD), suministro de refrigerante exterior

Dimensiones						Forma del mango HA	
d ₁ m7	d ₂ h6	l ₁	l ₂	l ₃	l ₄	Especificación	Referencia
11,40	12	102	55	40	45	SCD600-1140-2-2-140HA03-HP358	30801235
11,50	12	102	55	40	45	SCD600-1150-2-2-140HA03-HP358	30801237
11,60	12	102	55	40	45	SCD600-1160-2-2-140HA03-HP358	30801238
11,70	12	102	55	40	45	SCD600-1170-2-2-140HA03-HP358	30801239
11,80	12	102	55	40	45	SCD600-1180-2-2-140HA03-HP358	30801240
11,90	12	102	55	40	45	SCD600-1190-2-2-140HA03-HP358	30801241
12,00	12	102	55	40	45	SCD600-1200-2-2-140HA03-HP358	30801242
12,15	14	107	60	43	45	SCD600-1215-2-2-140HA03-HP358	30801243
12,25	14	107	60	43	45	SCD600-1225-2-2-140HA03-HP358	30801244
12,50	14	107	60	43	45	SCD600-1250-2-2-140HA03-HP358	30801245
12,55	14	107	60	43	45	SCD600-1255-2-2-140HA03-HP358	30801246
12,70	14	107	60	43	45	SCD600-1270-2-2-140HA03-HP358	30801247
12,80	14	107	60	43	45	SCD600-1280-2-2-140HA03-HP358	30801248
13,00	14	107	60	43	45	SCD600-1300-2-2-140HA03-HP358	30801250
13,10	14	107	60	43	45	SCD600-1310-2-2-140HA03-HP358	30801251
13,30	14	107	60	43	45	SCD600-1330-2-2-140HA03-HP358	30801252
13,35	14	107	60	43	45	SCD600-1335-2-2-140HA03-HP358	30801253
13,50	14	107	60	43	45	SCD600-1350-2-2-140HA03-HP358	30801254
13,70	14	107	60	43	45	SCD600-1370-2-2-140HA03-HP358	30801255
13,80	14	107	60	43	45	SCD600-1380-2-2-140HA03-HP358	30801256
14,00	14	107	60	43	45	SCD600-1400-2-2-140HA03-HP358	30801257
14,20	16	115	65	45	48	SCD600-1420-2-2-140HA03-HP358	30801258
14,50	16	115	65	45	48	SCD600-1450-2-2-140HA03-HP358	30801259
14,80	16	115	65	45	48	SCD600-1480-2-2-140HA03-HP358	30801260
15,00	16	115	65	45	48	SCD600-1500-2-2-140HA03-HP358	30801261
15,10	16	115	65	45	48	SCD600-1510-2-2-140HA03-HP358	30801262
15,25	16	115	65	45	48	SCD600-1525-2-2-140HA03-HP358	30801263
15,30	16	115	65	45	48	SCD600-1530-2-2-140HA03-HP358	30801264
15,35	16	115	65	45	48	SCD600-1535-2-2-140HA03-HP358	30801265
15,50	16	115	65	45	48	SCD600-1550-2-2-140HA03-HP358	30801266
15,60	16	115	65	45	48	SCD600-1560-2-2-140HA03-HP358	30801267
15,80	16	115	65	45	48	SCD600-1580-2-2-140HA03-HP358	30801268
16,00	16	115	65	45	48	SCD600-1600-2-2-140HA03-HP358	30801269
16,05	18	123	73	51	48	SCD600-1605-2-2-140HA03-HP358	30801270
16,50	18	123	73	51	48	SCD600-1650-2-2-140HA03-HP358	30801271
16,80	18	123	73	51	48	SCD600-1680-2-2-140HA03-HP358	30801272
17,00	18	123	73	51	48	SCD600-1700-2-2-140HA03-HP358	30801274
17,50	18	123	73	51	48	SCD600-1750-2-2-140HA03-HP358	30801275
17,80	18	123	73	51	48	SCD600-1780-2-2-140HA03-HP358	30801277
18,00	18	123	73	51	48	SCD600-1800-2-2-140HA03-HP358	30801278
18,50	20	131	79	55	50	SCD600-1850-2-2-140HA03-HP358	30801279
19,00	20	131	79	55	50	SCD600-1900-2-2-140HA03-HP358	30801282
19,35	20	131	79	55	50	SCD600-1935-2-2-140HA03-HP358	30801283
19,60	20	131	79	55	50	SCD600-1960-2-2-140HA03-HP358	30801285
19,80	20	131	79	55	50	SCD600-1980-2-2-140HA03-HP358	30801286
20,00	20	131	79	55	50	SCD600-2000-2-2-140HA03-HP358	30801287

Continúa en la página siguiente.

MEGA-Drill-Steel-Plus | Broca helicoidal de metal duro SCD600 (3xD), suministro de refrigerante exterior

Características configurables

**Diámetro:**

Diámetro seleccionable libremente en incrementos de 0,01 mm

**Forma del mango:**

Forma del mango: HB | HE

Especificación

SCD600-[diámetro]-3-3-140[forma del mango]03-HP358

Dimensiones de la serie configurable

d ₁ min.	d ₁ max.	d ₂ h6	l ₁	l ₂	l ₃	l ₄
3,00	3,70	6	62	20	14	36
3,71	4,70	6	66	24	17	36
4,71	6,00	6	66	28	20	36
6,01	7,00	8	79	34	24	36
7,01	8,00	8	79	41	29	36
8,01	10,00	10	89	47	35	40
10,01	12,00	12	102	55	40	45
12,01	14,00	14	107	60	43	45
14,01	16,00	16	115	65	45	48
16,01	18,00	18	123	73	51	48
18,01	20,00	20	131	79	55	50

Ejemplo:

SCD600-0431-3-3-140HE03-HP358

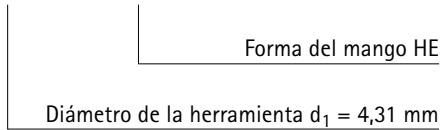

Medidas en mm.

* Especialmente indicada para la prefabricación de los agujeros para rosca para machos de laminación.

Para la recomendación de valores de corte, véase al final del capítulo.

Ejecuciones especiales y otros recubrimientos a petición.

MEGA-Drill-Steel-Plus

Broca helicoidal de metal duro

SCD601 (3xD), suministro de refrigerante interior, producto sucesor de la MEGA-Drill-Steel (SCD10)

Ejecución:

Diámetro de broca:	3,00 – 25,00 mm
Tolerancia del agujero:	≥ IT 9
Material de corte:	HP358
Número de insertos:	2
Número de biseles guía:	2
Ángulo de la punta:	140°
Ángulo de hélice:	30°

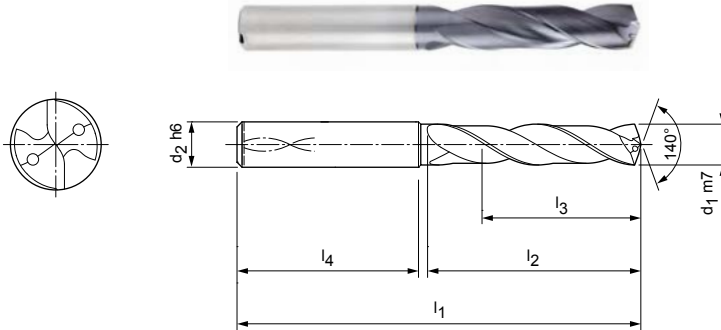

Serie preferente disponible en stock en forma de mango HA

Dimensiones						Forma del mango HA	
d ₁ m7	d ₂ h6	l ₁	l ₂	l ₃	l ₄	Especificación	Referencia
3,00	6	62	20	14	36	SCD601-0300-2-2-140HA03-HP358	30802107
3,10	6	62	20	14	36	SCD601-0310-2-2-140HA03-HP358	30802108
3,15	6	62	20	14	36	SCD601-0315-2-2-140HA03-HP358	30802109
3,20	6	62	20	14	36	SCD601-0320-2-2-140HA03-HP358	30802110
3,22	6	62	20	14	36	SCD601-0322-2-2-140HA03-HP358	30802111
3,25	6	62	20	14	36	SCD601-0325-2-2-140HA03-HP358	30802112
3,30	6	62	20	14	36	SCD601-0330-2-2-140HA03-HP358	30802113
3,40	6	62	20	14	36	SCD601-0340-2-2-140HA03-HP358	30802115
3,50	6	62	20	14	36	SCD601-0350-2-2-140HA03-HP358	30802116
3,60	6	62	20	14	36	SCD601-0360-2-2-140HA03-HP358	30802117
3,70*	6	62	20	14	36	SCD601-0370-2-2-140HA03-HP358	30802118
3,80	6	66	24	17	36	SCD601-0380-2-2-140HA03-HP358	30802119
3,85	6	66	24	17	36	SCD601-0385-2-2-140HA03-HP358	30802120
3,90	6	66	24	17	36	SCD601-0390-2-2-140HA03-HP358	30802121
4,00	6	66	24	17	36	SCD601-0400-2-2-140HA03-HP358	30802122
4,10	6	66	24	17	36	SCD601-0410-2-2-140HA03-HP358	30802123
4,20	6	66	24	17	36	SCD601-0420-2-2-140HA03-HP358	30802124
4,25	6	66	24	17	36	SCD601-0425-2-2-140HA03-HP358	30802125
4,30	6	66	24	17	36	SCD601-0430-2-2-140HA03-HP358	30802126
4,40	6	66	24	17	36	SCD601-0440-2-2-140HA03-HP358	30802129
4,50	6	66	24	17	36	SCD601-0450-2-2-140HA03-HP358	30802131
4,60	6	66	24	17	36	SCD601-0460-2-2-140HA03-HP358	30802132
4,65*	6	66	24	17	36	SCD601-0465-2-2-140HA03-HP358	30802133
4,70	6	66	24	17	36	SCD601-0470-2-2-140HA03-HP358	30802134
4,80	6	66	28	20	36	SCD601-0480-2-2-140HA03-HP358	30802135
4,90	6	66	28	20	36	SCD601-0490-2-2-140HA03-HP358	30802136
4,95	6	66	28	20	36	SCD601-0495-2-2-140HA03-HP358	30802137
5,00	6	66	28	20	36	SCD601-0500-2-2-140HA03-HP358	30802138
5,05	6	66	28	20	36	SCD601-0505-2-2-140HA03-HP358	30802139
5,10	6	66	28	20	36	SCD601-0510-2-2-140HA03-HP358	30802140
5,20	6	66	28	20	36	SCD601-0520-2-2-140HA03-HP358	30802141
5,30	6	66	28	20	36	SCD601-0530-2-2-140HA03-HP358	30802142
5,40	6	66	28	20	36	SCD601-0540-2-2-140HA03-HP358	30802143
5,50	6	66	28	20	36	SCD601-0550-2-2-140HA03-HP358	30802144
5,55*	6	66	28	20	36	SCD601-0555-2-2-140HA03-HP358	30802145

Continúa en la página siguiente.

MEGA-Drill-Steel-Plus | Broca helicoidal de metal duro SCD601 (3xD), suministro de refrigerante interior

Dimensiones						Forma del mango HA	
d ₁ m7	d ₂ h6	l ₁	l ₂	l ₃	l ₄	Especificación	Referencia
5,60	6	66	28	20	36	SCD601-0560-2-2-140HA03-HP358	30802146
5,70	6	66	28	20	36	SCD601-0570-2-2-140HA03-HP358	30802147
5,75	6	66	28	20	36	SCD601-0575-2-2-140HA03-HP358	30802148
5,80	6	66	28	20	36	SCD601-0580-2-2-140HA03-HP358	30802149
5,90	6	66	28	20	36	SCD601-0590-2-2-140HA03-HP358	30802150
5,95	6	66	28	20	36	SCD601-0595-2-2-140HA03-HP358	30802151
6,00	6	66	28	20	36	SCD601-0600-2-2-140HA03-HP358	30802152
6,10	8	79	34	24	36	SCD601-0610-2-2-140HA03-HP358	30802153
6,20	8	79	34	24	36	SCD601-0620-2-2-140HA03-HP358	30802154
6,30	8	79	34	24	36	SCD601-0630-2-2-140HA03-HP358	30802155
6,40	8	79	34	24	36	SCD601-0640-2-2-140HA03-HP358	30802156
6,50	8	79	34	24	36	SCD601-0650-2-2-140HA03-HP358	30802157
6,60	8	79	34	24	36	SCD601-0660-2-2-140HA03-HP358	30802158
6,70	8	79	34	24	36	SCD601-0670-2-2-140HA03-HP358	30802159
6,80	8	79	34	24	36	SCD601-0680-2-2-140HA03-HP358	30802160
6,90	8	79	34	24	36	SCD601-0690-2-2-140HA03-HP358	30802161
7,00	8	79	34	24	36	SCD601-0700-2-2-140HA03-HP358	30802162
7,10	8	79	41	29	36	SCD601-0710-2-2-140HA03-HP358	30802163
7,20	8	79	41	29	36	SCD601-0720-2-2-140HA03-HP358	30802164
7,30	8	79	41	29	36	SCD601-0730-2-2-140HA03-HP358	30802165
7,40	8	79	41	29	36	SCD601-0740-2-2-140HA03-HP358	30802166
7,45*	8	79	41	29	36	SCD601-0745-2-2-140HA03-HP358	30802167
7,50	8	79	41	29	36	SCD601-0750-2-2-140HA03-HP358	30802168
7,60	8	79	41	29	36	SCD601-0760-2-2-140HA03-HP358	30802169
7,70	8	79	41	29	36	SCD601-0770-2-2-140HA03-HP358	30802170
7,80	8	79	41	29	36	SCD601-0780-2-2-140HA03-HP358	30802171
7,90	8	79	41	29	36	SCD601-0790-2-2-140HA03-HP358	30802172
8,00	8	79	41	29	36	SCD601-0800-2-2-140HA03-HP358	30802173
8,10	10	89	47	35	40	SCD601-0810-2-2-140HA03-HP358	30802174
8,20	10	89	47	35	40	SCD601-0820-2-2-140HA03-HP358	30802175
8,30	10	89	47	35	40	SCD601-0830-2-2-140HA03-HP358	30802176
8,40	10	89	47	35	40	SCD601-0840-2-2-140HA03-HP358	30802177
8,50	10	89	47	35	40	SCD601-0850-2-2-140HA03-HP358	30802178
8,60	10	89	47	35	40	SCD601-0860-2-2-140HA03-HP358	30802179
8,70	10	89	47	35	40	SCD601-0870-2-2-140HA03-HP358	30802180
8,80	10	89	47	35	40	SCD601-0880-2-2-140HA03-HP358	30802181
8,90	10	89	47	35	40	SCD601-0890-2-2-140HA03-HP358	30802182
9,00	10	89	47	35	40	SCD601-0900-2-2-140HA03-HP358	30802183
9,10	10	89	47	35	40	SCD601-0910-2-2-140HA03-HP358	30802184
9,20	10	89	47	35	40	SCD601-0920-2-2-140HA03-HP358	30802185
9,30*	10	89	47	35	40	SCD601-0930-2-2-140HA03-HP358	30802186
9,35	10	89	47	35	40	SCD601-0935-2-2-140HA03-HP358	30802187
9,40	10	89	47	35	40	SCD601-0940-2-2-140HA03-HP358	30802188
9,50	10	89	47	35	40	SCD601-0950-2-2-140HA03-HP358	30802190
9,60	10	89	47	35	40	SCD601-0960-2-2-140HA03-HP358	30802191
9,70	10	89	47	35	40	SCD601-0970-2-2-140HA03-HP358	30802192
9,80	10	89	47	35	40	SCD601-0980-2-2-140HA03-HP358	30802193
9,90	10	89	47	35	40	SCD601-0990-2-2-140HA03-HP358	30802194
10,00	10	89	47	35	40	SCD601-1000-2-2-140HA03-HP358	30802195
10,10	12	102	55	40	45	SCD601-1010-2-2-140HA03-HP358	30802196
10,20	12	102	55	40	45	SCD601-1020-2-2-140HA03-HP358	30802197
10,30	12	102	55	40	45	SCD601-1030-2-2-140HA03-HP358	30802198
10,40	12	102	55	40	45	SCD601-1040-2-2-140HA03-HP358	30802199
10,50	12	102	55	40	45	SCD601-1050-2-2-140HA03-HP358	30802200
10,55	12	102	55	40	45	SCD601-1055-2-2-140HA03-HP358	30802201
10,60	12	102	55	40	45	SCD601-1060-2-2-140HA03-HP358	30802202
10,70	12	102	55	40	45	SCD601-1070-2-2-140HA03-HP358	30802203

MEGA-Drill-Steel-Plus | Broca helicoidal de metal duro SCD601 (3xD), suministro de refrigerante interior

Dimensiones						Forma del mango HA	
d ₁ m7	d ₂ h6	l ₁	l ₂	l ₃	l ₄	Especificación	Referencia
10,75	12	102	55	40	45	SCD601-1075-2-2-140HA03-HP358	30802204
10,80	12	102	55	40	45	SCD601-1080-2-2-140HA03-HP358	30802205
10,90	12	102	55	40	45	SCD601-1090-2-2-140HA03-HP358	30802206
11,00	12	102	55	40	45	SCD601-1100-2-2-140HA03-HP358	30802207
11,10	12	102	55	40	45	SCD601-1110-2-2-140HA03-HP358	30802208
11,20*	12	102	55	40	45	SCD601-1120-2-2-140HA03-HP358	30802209
11,25	12	102	55	40	45	SCD601-1125-2-2-140HA03-HP358	30802210
11,30	12	102	55	40	45	SCD601-1130-2-2-140HA03-HP358	30802211
11,45	12	102	55	40	45	SCD601-1145-2-2-140HA03-HP358	30802214
11,50	12	102	55	40	45	SCD601-1150-2-2-140HA03-HP358	30802215
11,60	12	102	55	40	45	SCD601-1160-2-2-140HA03-HP358	30802216
11,70	12	102	55	40	45	SCD601-1170-2-2-140HA03-HP358	30802217
11,80	12	102	55	40	45	SCD601-1180-2-2-140HA03-HP358	30802218
11,90	12	102	55	40	45	SCD601-1190-2-2-140HA03-HP358	30802219
12,00	12	102	55	40	45	SCD601-1200-2-2-140HA03-HP358	30802220
12,15	14	107	60	43	45	SCD601-1215-2-2-140HA03-HP358	30802221
12,20	14	107	60	43	45	SCD601-1220-2-2-140HA03-HP358	31307544
12,25	14	107	60	43	45	SCD601-1225-2-2-140HA03-HP358	30802222
12,50	14	107	60	43	45	SCD601-1250-2-2-140HA03-HP358	30802223
12,55	14	107	60	43	45	SCD601-1255-2-2-140HA03-HP358	30802224
12,70	14	107	60	43	45	SCD601-1270-2-2-140HA03-HP358	30802225
12,80	14	107	60	43	45	SCD601-1280-2-2-140HA03-HP358	30802226
12,90	14	107	60	43	45	SCD601-1290-2-2-140HA03-HP358	30802227
13,00	14	107	60	43	45	SCD601-1300-2-2-140HA03-HP358	30802228
13,10	14	107	60	43	45	SCD601-1310-2-2-140HA03-HP358	30802229
13,30	14	107	60	43	45	SCD601-1330-2-2-140HA03-HP358	30802230
13,35	14	107	60	43	45	SCD601-1335-2-2-140HA03-HP358	30802231
13,50	14	107	60	43	45	SCD601-1350-2-2-140HA03-HP358	30802232
13,70	14	107	60	43	45	SCD601-1370-2-2-140HA03-HP358	30802233
13,80	14	107	60	43	45	SCD601-1380-2-2-140HA03-HP358	30802234
14,00	14	107	60	43	45	SCD601-1400-2-2-140HA03-HP358	30802235
14,20	16	115	65	45	48	SCD601-1420-2-2-140HA03-HP358	30802236
14,50	16	115	65	45	48	SCD601-1450-2-2-140HA03-HP358	30802237
14,80	16	115	65	45	48	SCD601-1480-2-2-140HA03-HP358	30802238
15,00	16	115	65	45	48	SCD601-1500-2-2-140HA03-HP358	30802239
15,10	16	115	65	45	48	SCD601-1510-2-2-140HA03-HP358	30802240
15,25	16	115	65	45	48	SCD601-1525-2-2-140HA03-HP358	30802241
15,30	16	115	65	45	48	SCD601-1530-2-2-140HA03-HP358	30802242
15,35	16	115	65	45	48	SCD601-1535-2-2-140HA03-HP358	30802243
15,50	16	115	65	45	48	SCD601-1550-2-2-140HA03-HP358	30802244
15,60	16	115	65	45	48	SCD601-1560-2-2-140HA03-HP358	30802245
15,80	16	115	65	45	48	SCD601-1580-2-2-140HA03-HP358	30802246
16,00	16	115	65	45	48	SCD601-1600-2-2-140HA03-HP358	30802247
16,05	18	123	73	51	48	SCD601-1605-2-2-140HA03-HP358	30802248
16,50	18	123	73	51	48	SCD601-1650-2-2-140HA03-HP358	30802249
16,60	18	123	73	51	48	SCD601-1660-2-2-140HA03-HP358	31307545
16,90	18	123	73	51	48	SCD601-1690-2-2-140HA03-HP358	30802251
17,00	18	123	73	51	48	SCD601-1700-2-2-140HA03-HP358	30802252
17,50	18	123	73	51	48	SCD601-1750-2-2-140HA03-HP358	30802253
17,60	18	123	73	51	48	SCD601-1760-2-2-140HA03-HP358	30802254
17,80	18	123	73	51	48	SCD601-1780-2-2-140HA03-HP358	30802255
18,00	18	123	73	51	48	SCD601-1800-2-2-140HA03-HP358	30802256
18,50	20	131	79	55	50	SCD601-1850-2-2-140HA03-HP358	30802257
18,90	20	131	79	55	50	SCD601-1890-2-2-140HA03-HP358	30802259
19,00	20	131	79	55	50	SCD601-1900-2-2-140HA03-HP358	30802260
19,35	20	131	79	55	50	SCD601-1935-2-2-140HA03-HP358	30802261
19,50	20	131	79	55	50	SCD601-1950-2-2-140HA03-HP358	30802262

Continúa en la página siguiente.

MEGA-Drill-Steel-Plus | Broca helicoidal de metal duro SCD601 (3xD), suministro de refrigerante interior

Dimensiones						Forma del mango HA	
d ₁ m7	d ₂ h6	l ₁	l ₂	l ₃	l ₄	Especificación	Referencia
19,80	20	131	79	55	50	SCD601-1980-2-2-140HA03-HP358	30802264
20,00	20	131	79	55	50	SCD601-2000-2-2-140HA03-HP358	30802265
21,00	25	151	93	66	56	SCD601-2100-2-2-140HA03-HP358	30802267
21,50	25	151	93	66	56	SCD601-2150-2-2-140HA03-HP358	30802268
22,00	25	151	93	66	56	SCD601-2200-2-2-140HA03-HP358	30802269
23,50	25	151	93	66	56	SCD601-2350-2-2-140HA03-HP358	30802272

Características configurables



Diámetro:
Diámetro seleccionable libremente en incrementos de 0,01 mm





Forma del mango:
Forma del mango: HB | HE

Especificación
SCD601-[diámetro]-3-3-140[forma del mango]03-HP358

Dimensiones de la serie configurable

d ₁ min.	d ₁ max.	d ₂ h6	l ₁	l ₂	l ₃	l ₄
3,00	3,70	6	62	20	14	36
3,71	4,70	6	66	24	17	36
4,71	6,00	6	66	28	20	36
6,01	7,00	8	79	34	24	36
7,01	8,00	8	79	41	29	36
8,01	10,00	10	89	47	35	40
10,01	12,00	12	102	55	40	45
12,01	14,00	14	107	60	43	45
14,01	16,00	16	115	65	45	48
16,01	18,00	18	123	73	51	48
18,01	20,00	20	131	79	55	50
20,01	25,00	25	151	93	66	56

Ejemplo:

SCD601-0431-3-3-140HE03-HP358

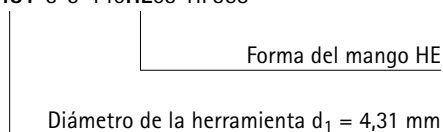

Medidas en mm.

* Especialmente indicada para la prefabricación de los agujeros para rosca para machos de laminación.

Para la recomendación de valores de corte, véase al final del capítulo.

Ejecuciones especiales y otros recubrimientos a petición.

MEGA-Drill-Steel-Plus

Broca helicoidal de metal duro

SCD600 (5xD), suministro de refrigerante exterior, producto sucesor de la MEGA-Speed-Drill-Steel (SCD10)

Ejecución:

Diámetro de broca:	3,00 – 20,00 mm
Tolerancia del agujero:	≥ IT 9
Material de corte:	HP358
Número de insertos:	2
Número de biseles guía:	2
Ángulo de la punta:	140°
Ángulo de hélice:	30°

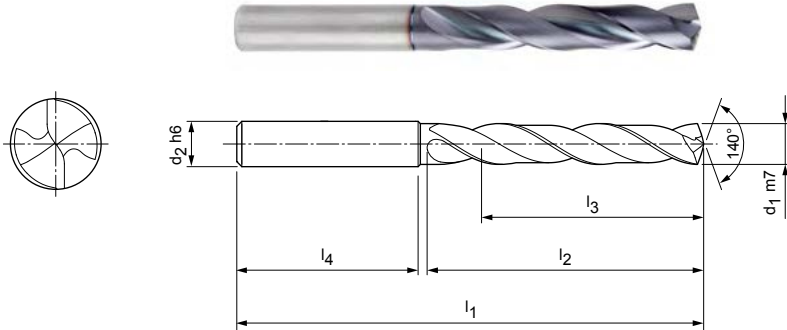

Serie preferente disponible en stock en forma de mango HA

Dimensiones						Forma del mango HA	
d ₁ m7	d ₂ h6	l ₁	l ₂	l ₃	l ₄	Especificación	Referencia
3,00	6	66	28	23	36	SCD600-0300-2-2-140HA05-HP358	30801634
3,10	6	66	28	23	36	SCD600-0310-2-2-140HA05-HP358	30801635
3,15	6	66	28	23	36	SCD600-0315-2-2-140HA05-HP358	30801636
3,20	6	66	28	23	36	SCD600-0320-2-2-140HA05-HP358	30801637
3,25	6	66	28	23	36	SCD600-0325-2-2-140HA05-HP358	30801639
3,30	6	66	28	23	36	SCD600-0330-2-2-140HA05-HP358	30801640
3,40	6	66	28	23	36	SCD600-0340-2-2-140HA05-HP358	30801641
3,50	6	66	28	23	36	SCD600-0350-2-2-140HA05-HP358	30801642
3,60	6	66	28	23	36	SCD600-0360-2-2-140HA05-HP358	30801643
3,70	6	66	28	23	36	SCD600-0370-2-2-140HA05-HP358	30801644
3,80	6	74	36	29	36	SCD600-0380-2-2-140HA05-HP358	30801645
3,90	6	74	36	29	36	SCD600-0390-2-2-140HA05-HP358	30801647
4,00	6	74	36	29	36	SCD600-0400-2-2-140HA05-HP358	30801648
4,10	6	74	36	29	36	SCD600-0410-2-2-140HA05-HP358	30801649
4,20	6	74	36	29	36	SCD600-0420-2-2-140HA05-HP358	30801650
4,25	6	74	36	29	36	SCD600-0425-2-2-140HA05-HP358	30801651
4,30	6	74	36	29	36	SCD600-0430-2-2-140HA05-HP358	30801652
4,35	6	74	36	29	36	SCD600-0435-2-2-140HA05-HP358	30801653
4,40	6	74	36	29	36	SCD600-0440-2-2-140HA05-HP358	30801654
4,50	6	74	36	29	36	SCD600-0450-2-2-140HA05-HP358	30801656
4,60	6	74	36	29	36	SCD600-0460-2-2-140HA05-HP358	30801657
4,65	6	74	36	29	36	SCD600-0465-2-2-140HA05-HP358	30801658
4,70	6	74	36	29	36	SCD600-0470-2-2-140HA05-HP358	30801659
4,80	6	82	44	35	36	SCD600-0480-2-2-140HA05-HP358	30801660
4,90	6	82	44	35	36	SCD600-0490-2-2-140HA05-HP358	30801662
4,95	6	82	44	35	36	SCD600-0495-2-2-140HA05-HP358	30801663
5,00	6	82	44	35	36	SCD600-0500-2-2-140HA05-HP358	30801664
5,05	6	82	44	35	36	SCD600-0505-2-2-140HA05-HP358	30801665
5,10	6	82	44	35	36	SCD600-0510-2-2-140HA05-HP358	30801666
5,20	6	82	44	35	36	SCD600-0520-2-2-140HA05-HP358	30801667
5,30	6	82	44	35	36	SCD600-0530-2-2-140HA05-HP358	30801668
5,40	6	82	44	35	36	SCD600-0540-2-2-140HA05-HP358	30801669
5,50	6	82	44	35	36	SCD600-0550-2-2-140HA05-HP358	30801670
5,55	6	82	44	35	36	SCD600-0555-2-2-140HA05-HP358	30801671
5,60	6	82	44	35	36	SCD600-0560-2-2-140HA05-HP358	30801672

Continúa en la página siguiente.

MEGA-Drill-Steel-Plus | Broca helicoidal de metal duro SCD600 (5xD), suministro de refrigerante exterior

Dimensiones						Forma del mango HA	
d ₁ m7	d ₂ h6	l ₁	l ₂	l ₃	l ₄	Especificación	Referencia
5,70	6	82	44	35	36	SCD600-0570-2-2-140HA05-HP358	30801673
5,75	6	82	44	35	36	SCD600-0575-2-2-140HA05-HP358	30801674
5,80	6	82	44	35	36	SCD600-0580-2-2-140HA05-HP358	30801675
5,90	6	82	44	35	36	SCD600-0590-2-2-140HA05-HP358	30801676
5,95	6	82	44	35	36	SCD600-0595-2-2-140HA05-HP358	30801677
6,00	6	82	44	35	36	SCD600-0600-2-2-140HA05-HP358	30801678
6,10	8	91	53	43	36	SCD600-0610-2-2-140HA05-HP358	30801679
6,20	8	91	53	43	36	SCD600-0620-2-2-140HA05-HP358	30801680
6,30	8	91	53	43	36	SCD600-0630-2-2-140HA05-HP358	30801681
6,40	8	91	53	43	36	SCD600-0640-2-2-140HA05-HP358	30801682
6,50	8	91	53	43	36	SCD600-0650-2-2-140HA05-HP358	30801683
6,60	8	91	53	43	36	SCD600-0660-2-2-140HA05-HP358	30801684
6,70	8	91	53	43	36	SCD600-0670-2-2-140HA05-HP358	30801685
6,80	8	91	53	43	36	SCD600-0680-2-2-140HA05-HP358	30801686
6,90	8	91	53	43	36	SCD600-0690-2-2-140HA05-HP358	30801687
7,00	8	91	53	43	36	SCD600-0700-2-2-140HA05-HP358	30801688
7,10	8	91	53	43	36	SCD600-0710-2-2-140HA05-HP358	30801689
7,20	8	91	53	43	36	SCD600-0720-2-2-140HA05-HP358	30801690
7,30	8	91	53	43	36	SCD600-0730-2-2-140HA05-HP358	30801691
7,40	8	91	53	43	36	SCD600-0740-2-2-140HA05-HP358	30801692
7,45	8	91	53	43	36	SCD600-0745-2-2-140HA05-HP358	30801693
7,50	8	91	53	43	36	SCD600-0750-2-2-140HA05-HP358	30801694
7,60	8	91	53	43	36	SCD600-0760-2-2-140HA05-HP358	30801695
7,80	8	91	53	43	36	SCD600-0780-2-2-140HA05-HP358	30801697
7,90	8	91	53	43	36	SCD600-0790-2-2-140HA05-HP358	30801698
8,00	8	91	53	43	36	SCD600-0800-2-2-140HA05-HP358	30801699
8,10	10	103	61	49	40	SCD600-0810-2-2-140HA05-HP358	30801700
8,20	10	103	61	49	40	SCD600-0820-2-2-140HA05-HP358	30801701
8,30	10	103	61	49	40	SCD600-0830-2-2-140HA05-HP358	30801702
8,40	10	103	61	49	40	SCD600-0840-2-2-140HA05-HP358	30801703
8,50	10	103	61	49	40	SCD600-0850-2-2-140HA05-HP358	30801704
8,60	10	103	61	49	40	SCD600-0860-2-2-140HA05-HP358	30801705
8,70	10	103	61	49	40	SCD600-0870-2-2-140HA05-HP358	30801706
8,80	10	103	61	49	40	SCD600-0880-2-2-140HA05-HP358	30801707
8,90	10	103	61	49	40	SCD600-0890-2-2-140HA05-HP358	30801708
9,00	10	103	61	49	40	SCD600-0900-2-2-140HA05-HP358	30801709
9,10	10	103	61	49	40	SCD600-0910-2-2-140HA05-HP358	30801710
9,20	10	103	61	49	40	SCD600-0920-2-2-140HA05-HP358	30801711
9,30	10	103	61	49	40	SCD600-0930-2-2-140HA05-HP358	30801712
9,50	10	103	61	49	40	SCD600-0950-2-2-140HA05-HP358	30801716
9,60	10	103	61	49	40	SCD600-0960-2-2-140HA05-HP358	30801717
9,70	10	103	61	49	40	SCD600-0970-2-2-140HA05-HP358	30801718
9,80	10	103	61	49	40	SCD600-0980-2-2-140HA05-HP358	30801719
9,90	10	103	61	49	40	SCD600-0990-2-2-140HA05-HP358	30801720
10,00	10	103	61	49	40	SCD600-1000-2-2-140HA05-HP358	30801721
10,10	12	118	71	56	45	SCD600-1010-2-2-140HA05-HP358	30801722
10,20	12	118	71	56	45	SCD600-1020-2-2-140HA05-HP358	30801723
10,30	12	118	71	56	45	SCD600-1030-2-2-140HA05-HP358	30801724
10,40	12	118	71	56	45	SCD600-1040-2-2-140HA05-HP358	30801725
10,50	12	118	71	56	45	SCD600-1050-2-2-140HA05-HP358	30801726
10,70	12	118	71	56	45	SCD600-1070-2-2-140HA05-HP358	30801729
10,75	12	118	71	56	45	SCD600-1075-2-2-140HA05-HP358	30801731
10,80	12	118	71	56	45	SCD600-1080-2-2-140HA05-HP358	30801732
11,00	12	118	71	56	45	SCD600-1100-2-2-140HA05-HP358	30801734
11,20	12	118	71	56	45	SCD600-1120-2-2-140HA05-HP358	30801736
11,25	12	118	71	56	45	SCD600-1125-2-2-140HA05-HP358	30801737
11,30	12	118	71	56	45	SCD600-1130-2-2-140HA05-HP358	30801738

MEGA-Drill-Steel-Plus | Broca helicoidal de metal duro SCD600 (5xD), suministro de refrigerante exterior

Dimensiones						Forma del mango HA	
d ₁ m7	d ₂ h6	l ₁	l ₂	l ₃	l ₄	Especificación	Referencia
11,35	12	118	71	56	45	SCD600-1135-2-2-140HA05-HP358	30801739
11,50	12	118	71	56	45	SCD600-1150-2-2-140HA05-HP358	30801742
11,80	12	118	71	56	45	SCD600-1180-2-2-140HA05-HP358	30801745
11,90	12	118	71	56	45	SCD600-1190-2-2-140HA05-HP358	30801746
12,00	12	118	71	56	45	SCD600-1200-2-2-140HA05-HP358	30801747
12,15	14	124	77	60	45	SCD600-1215-2-2-140HA05-HP358	30801748
12,25	14	124	77	60	45	SCD600-1225-2-2-140HA05-HP358	30801749
12,50	14	124	77	60	45	SCD600-1250-2-2-140HA05-HP358	30801750
12,70	14	124	77	60	45	SCD600-1270-2-2-140HA05-HP358	30801752
12,80	14	124	77	60	45	SCD600-1280-2-2-140HA05-HP358	30801753
12,90	14	124	77	60	45	SCD600-1290-2-2-140HA05-HP358	30801754
13,00	14	124	77	60	45	SCD600-1300-2-2-140HA05-HP358	30801755
13,10	14	124	77	60	45	SCD600-1310-2-2-140HA05-HP358	30801756
13,30	14	124	77	60	45	SCD600-1330-2-2-140HA05-HP358	30801757
13,35	14	124	77	60	45	SCD600-1335-2-2-140HA05-HP358	30801758
13,50	14	124	77	60	45	SCD600-1350-2-2-140HA05-HP358	30801759
13,80	14	124	77	60	45	SCD600-1380-2-2-140HA05-HP358	30801761
14,00	14	124	77	60	45	SCD600-1400-2-2-140HA05-HP358	30801762
14,20	16	133	83	63	48	SCD600-1420-2-2-140HA05-HP358	30801763
14,50	16	133	83	63	48	SCD600-1450-2-2-140HA05-HP358	30801764
14,80	16	133	83	63	48	SCD600-1480-2-2-140HA05-HP358	30801765
15,00	16	133	83	63	48	SCD600-1500-2-2-140HA05-HP358	30801766
15,10	16	133	83	63	48	SCD600-1510-2-2-140HA05-HP358	30801767
15,25	16	133	83	63	48	SCD600-1525-2-2-140HA05-HP358	30801768
15,30	16	133	83	63	48	SCD600-1530-2-2-140HA05-HP358	30801769
15,50	16	133	83	63	48	SCD600-1550-2-2-140HA05-HP358	30801771
15,80	16	133	83	63	48	SCD600-1580-2-2-140HA05-HP358	30801773
16,00	16	133	83	63	48	SCD600-1600-2-2-140HA05-HP358	30801774
16,50	18	143	93	71	48	SCD600-1650-2-2-140HA05-HP358	30801776
16,80	18	143	93	71	48	SCD600-1680-2-2-140HA05-HP358	30801777
17,00	18	143	93	71	48	SCD600-1700-2-2-140HA05-HP358	30801779
17,50	18	143	93	71	48	SCD600-1750-2-2-140HA05-HP358	30801780
17,60	18	143	93	71	48	SCD600-1760-2-2-140HA05-HP358	30801781
18,00	18	143	93	71	48	SCD600-1800-2-2-140HA05-HP358	30801783
18,50	20	153	101	77	50	SCD600-1850-2-2-140HA05-HP358	30801784
18,80	20	153	101	77	50	SCD600-1880-2-2-140HA05-HP358	30801785
18,90	20	153	101	77	50	SCD600-1890-2-2-140HA05-HP358	30801786
19,00	20	153	101	77	50	SCD600-1900-2-2-140HA05-HP358	30801787
19,50	20	153	101	77	50	SCD600-1950-2-2-140HA05-HP358	30801789
19,80	20	153	101	77	50	SCD600-1980-2-2-140HA05-HP358	30801791
20,00	20	153	101	77	50	SCD600-2000-2-2-140HA05-HP358	30801792

Continúa en la página siguiente.

MEGA-Drill-Steel-Plus | Broca helicoidal de metal duro SCD600 (5xD), suministro de refrigerante exterior

Características configurables

**Diámetro:**

Diámetro seleccionable libremente en incrementos de 0,01 mm

**Forma del mango:**

Forma del mango: HB | HE

Especificación

SCD600-[diámetro]-3-3-140[forma del mango]05-HP358

Dimensiones de la serie configurable

d ₁ min.	d ₁ max.	d ₂ h6	l ₁	l ₂	l ₃	l ₄
3,00	3,70	6	66	28	23	36
3,71	4,70	6	74	36	29	36
4,71	6,00	6	82	44	35	36
6,01	8,00	8	91	53	43	36
8,01	10,00	10	103	61	49	40
10,01	12,00	12	118	71	56	45
12,01	14,00	14	124	77	60	45
14,01	16,00	16	133	83	63	48
16,01	18,00	18	143	93	71	48
18,01	20,00	20	153	101	77	50

Ejemplo:

SCD600-0431-3-3-140HE05-HP358

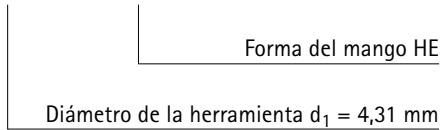

Medidas en mm.

Para la recomendación de valores de corte, véase al final del capítulo.

Ejecuciones especiales y otros recubrimientos a petición.

MEGA-Drill-Steel-Plus

Broca helicoidal de metal duro

SCD601 (5xD), suministro de refrigerante interior, producto sucesor de la MEGA-Drill-Steel (SCD10)

Ejecución:

Diámetro de broca: 3,00 – 25,00 mm
 Tolerancia del agujero: ≥ IT 9
 Material de corte: HP358
 Número de insertos: 2
 Número de biseles guía: 2
 Ángulo de la punta: 140°
 Ángulo de hélice: 30°

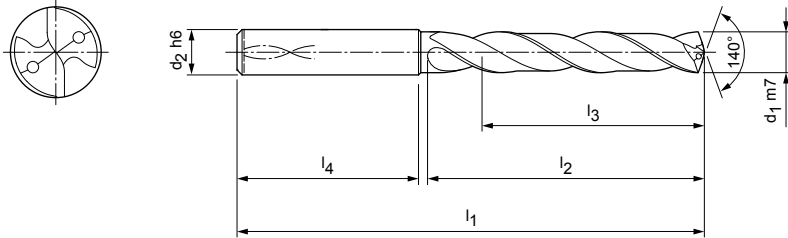

Serie preferente disponible en stock en forma de mango HA

Dimensiones						Forma del mango HA	
d ₁ m7	d ₂ h6	l ₁	l ₂	l ₃	l ₄	Especificación	Referencia
3,00	6	66	28	23	36	SCD601-0300-2-2-140HA05-HP358	30802611
3,10	6	66	28	23	36	SCD601-0310-2-2-140HA05-HP358	30802612
3,15	6	66	28	23	36	SCD601-0315-2-2-140HA05-HP358	30802613
3,20	6	66	28	23	36	SCD601-0320-2-2-140HA05-HP358	30802614
3,25	6	66	28	23	36	SCD601-0325-2-2-140HA05-HP358	30802616
3,30	6	66	28	23	36	SCD601-0330-2-2-140HA05-HP358	30802617
3,40	6	66	28	23	36	SCD601-0340-2-2-140HA05-HP358	30802618
3,50	6	66	28	23	36	SCD601-0350-2-2-140HA05-HP358	30802619
3,60	6	66	28	23	36	SCD601-0360-2-2-140HA05-HP358	30802620
3,65	6	66	28	23	36	SCD601-0365-2-2-140HA05-HP358	31307546
3,70*	6	66	28	23	36	SCD601-0370-2-2-140HA05-HP358	30802621
3,80	6	74	36	29	36	SCD601-0380-2-2-140HA05-HP358	30802622
3,85	6	74	36	29	36	SCD601-0385-2-2-140HA05-HP358	30802623
3,90	6	74	36	29	36	SCD601-0390-2-2-140HA05-HP358	30802624
4,00	6	74	36	29	36	SCD601-0400-2-2-140HA05-HP358	30802625
4,10	6	74	36	29	36	SCD601-0410-2-2-140HA05-HP358	30802626
4,20	6	74	36	29	36	SCD601-0420-2-2-140HA05-HP3583	30802627
4,25	6	74	36	29	36	SCD601-0425-2-2-140HA05-HP358	30802628
4,30	6	74	36	29	36	SCD601-0430-2-2-140HA05-HP358	30802629
4,35	6	74	36	29	36	SCD601-0435-2-2-140HA05-HP358	30802630
4,40	6	74	36	29	36	SCD601-0440-2-2-140HA05-HP358	30802631
4,45	6	74	36	29	36	SCD601-0445-2-2-140HA05-HP358	30802632
4,50	6	74	36	29	36	SCD601-0450-2-2-140HA05-HP358	30802633
4,60	6	74	36	29	36	SCD601-0460-2-2-140HA05-HP358	30802634
4,65*	6	74	36	29	36	SCD601-0465-2-2-140HA05-HP358	30802635
4,70	6	74	36	29	36	SCD601-0470-2-2-140HA05-HP358	30802636
4,80	6	82	44	35	36	SCD601-0480-2-2-140HA05-HP358	30802637
4,90	6	82	44	35	36	SCD601-0490-2-2-140HA05-HP358	30802638
4,95	6	82	44	35	36	SCD601-0495-2-2-140HA05-HP358	30802639
5,00	6	82	44	35	36	SCD601-0500-2-2-140HA05-HP358	30802640
5,05	6	82	44	35	36	SCD601-0505-2-2-140HA05-HP358	30802641
5,10	6	82	44	35	36	SCD601-0510-2-2-140HA05-HP358	30802642
5,20	6	82	44	35	36	SCD601-0520-2-2-140HA05-HP358	30802643
5,30	6	82	44	35	36	SCD601-0530-2-2-140HA05-HP358	30802644
5,40	6	82	44	35	36	SCD601-0540-2-2-140HA05-HP358	30802645

MEGA-Drill-Steel-Plus | Broca helicoidal de metal duro SCD601 (5xD), suministro de refrigerante interior

Dimensiones						Forma del mango HA	
d ₁ m7	d ₂ h6	l ₁	l ₂	l ₃	l ₄	Especificación	Referencia
5,50	6	82	44	35	36	SCD601-0550-2-2-140HA05-HP358	30802646
5,55*	6	82	44	35	36	SCD601-0555-2-2-140HA05-HP358	30802647
5,60	6	82	44	35	36	SCD601-0560-2-2-140HA05-HP358	30802648
5,70	6	82	44	35	36	SCD601-0570-2-2-140HA05-HP358	30802649
5,75	6	82	44	35	36	SCD601-0575-2-2-140HA05-HP358	30802650
5,80	6	82	44	35	36	SCD601-0580-2-2-140HA05-HP358	30802651
5,90	6	82	44	35	36	SCD601-0590-2-2-140HA05-HP358	30802652
5,95	6	82	44	35	36	SCD601-0595-2-2-140HA05-HP358	30802653
6,00	6	82	44	35	36	SCD601-0600-2-2-140HA05-HP358	30802654
6,10	8	91	53	43	36	SCD601-0610-2-2-140HA05-HP358	30802655
6,20	8	91	53	43	36	SCD601-0620-2-2-140HA05-HP358	30802656
6,30	8	91	53	43	36	SCD601-0630-2-2-140HA05-HP358	30802657
6,40	8	91	53	43	36	SCD601-0640-2-2-140HA05-HP358	30802658
6,50	8	91	53	43	36	SCD601-0650-2-2-140HA05-HP358	30802659
6,60	8	91	53	43	36	SCD601-0660-2-2-140HA05-HP358	30802660
6,70	8	91	53	43	36	SCD601-0670-2-2-140HA05-HP358	30802661
6,80	8	91	53	43	36	SCD601-0680-2-2-140HA05-HP358	30802662
6,90	8	91	53	43	36	SCD601-0690-2-2-140HA05-HP358	30802663
7,00	8	91	53	43	36	SCD601-0700-2-2-140HA05-HP358	30802664
7,10	8	91	53	43	36	SCD601-0710-2-2-140HA05-HP358	30802665
7,20	8	91	53	43	36	SCD601-0720-2-2-140HA05-HP358	30802666
7,30	8	91	53	43	36	SCD601-0730-2-2-140HA05-HP358	30802667
7,40	8	91	53	43	36	SCD601-0740-2-2-140HA05-HP358	30802668
7,45*	8	91	53	43	36	SCD601-0745-2-2-140HA05-HP358	30802669
7,50	8	91	53	43	36	SCD601-0750-2-2-140HA05-HP358	30802670
7,60	8	91	53	43	36	SCD601-0760-2-2-140HA05-HP358	30802671
7,70	8	91	53	43	36	SCD601-0770-2-2-140HA05-HP358	30802672
7,80	8	91	53	43	36	SCD601-0780-2-2-140HA05-HP358	30802673
7,90	8	91	53	43	36	SCD601-0790-2-2-140HA05-HP358	30802674
8,00	8	91	53	43	36	SCD601-0800-2-2-140HA05-HP358	30802675
8,10	10	103	61	49	40	SCD601-0810-2-2-140HA05-HP358	30802676
8,20	10	103	61	49	40	SCD601-0820-2-2-140HA05-HP358	30802677
8,30	10	103	61	49	40	SCD601-0830-2-2-140HA05-HP358	30802678
8,40	10	103	61	49	40	SCD601-0840-2-2-140HA05-HP358	30802679
8,50	10	103	61	49	40	SCD601-0850-2-2-140HA05-HP358	30802680
8,60	10	103	61	49	40	SCD601-0860-2-2-140HA05-HP358	30802681
8,70	10	103	61	49	40	SCD601-0870-2-2-140HA05-HP358	30802682
8,80	10	103	61	49	40	SCD601-0880-2-2-140HA05-HP358	30802683
8,90	10	103	61	49	40	SCD601-0890-2-2-140HA05-HP358	30802684
9,00	10	103	61	49	40	SCD601-0900-2-2-140HA05-HP358	30802685
9,10	10	103	61	49	40	SCD601-0910-2-2-140HA05-HP358	30802686
9,20	10	103	61	49	40	SCD601-0920-2-2-140HA05-HP358	30802687
9,30*	10	103	61	49	40	SCD601-0930-2-2-140HA05-HP358	30802688
9,35	10	103	61	49	40	SCD601-0935-2-2-140HA05-HP358	30802689
9,40	10	103	61	49	40	SCD601-0940-2-2-140HA05-HP358	30802690
9,45	10	103	61	49	40	SCD601-0945-2-2-140HA05-HP358	30802691
9,50	10	103	61	49	40	SCD601-0950-2-2-140HA05-HP358	30802692
9,60	10	103	61	49	40	SCD601-0960-2-2-140HA05-HP358	30802693
9,70	10	103	61	49	40	SCD601-0970-2-2-140HA05-HP358	30802694
9,80	10	103	61	49	40	SCD601-0980-2-2-140HA05-HP358	30802695
9,90	10	103	61	49	40	SCD601-0990-2-2-140HA05-HP358	30802696
10,00	10	103	61	49	40	SCD601-1000-2-2-140HA05-HP358	30802697
10,10	12	118	71	56	45	SCD601-1010-2-2-140HA05-HP358	30802698
10,20	12	118	71	56	45	SCD601-1020-2-2-140HA05-HP358	30802699
10,30	12	118	71	56	45	SCD601-1030-2-2-140HA05-HP358	30802700
10,40	12	118	71	56	45	SCD601-1040-2-2-140HA05-HP358	30802701
10,50	12	118	71	56	45	SCD601-1050-2-2-140HA05-HP358	30802702

MEGA-Drill-Steel-Plus | Broca helicoidal de metal duro SCD601 (5xD), suministro de refrigerante interior

Dimensiones						Forma del mango HA	
d ₁ m7	d ₂ h6	l ₁	l ₂	l ₃	l ₄	Especificación	Referencia
10,55	12	118	71	56	45	SCD601-1055-2-2-140HA05-HP358	30802703
10,60	12	118	71	56	45	SCD601-1060-2-2-140HA05-HP358	30802704
10,70	12	118	71	56	45	SCD601-1070-2-2-140HA05-HP358	30802705
10,80	12	118	71	56	45	SCD601-1080-2-2-140HA05-HP358	30802707
10,90	12	118	71	56	45	SCD601-1090-2-2-140HA05-HP358	30802708
11,00	12	118	71	56	45	SCD601-1100-2-2-140HA05-HP358	30802709
11,10	12	118	71	56	45	SCD601-1110-2-2-140HA05-HP358	30802710
11,20*	12	118	71	56	45	SCD601-1120-2-2-140HA05-HP358	30802711
11,25	12	118	71	56	45	SCD601-1125-2-2-140HA05-HP358	30802712
11,30	12	118	71	56	45	SCD601-1130-2-2-140HA05-HP358	30802713
11,40	12	118	71	56	45	SCD601-1140-2-2-140HA05-HP358	30802715
11,50	12	118	71	56	45	SCD601-1150-2-2-140HA05-HP358	30802717
11,60	12	118	71	56	45	SCD601-1160-2-2-140HA05-HP358	30802718
11,70	12	118	71	56	45	SCD601-1170-2-2-140HA05-HP358	30802719
11,80	12	118	71	56	45	SCD601-1180-2-2-140HA05-HP358	30802720
11,90	12	118	71	56	45	SCD601-1190-2-2-140HA05-HP358	30802721
12,00	12	118	71	56	45	SCD601-1200-2-2-140HA05-HP358	30802722
12,15	14	124	77	60	45	SCD601-1215-2-2-140HA05-HP358	30802723
12,25	14	124	77	60	45	SCD601-1225-2-2-140HA05-HP358	30802724
12,30	14	124	77	60	45	SCD601-1230-2-2-140HA05-HP358	31201193
12,50	14	124	77	60	45	SCD601-1250-2-2-140HA05-HP358	30802725
12,55	14	124	77	60	45	SCD601-1255-2-2-140HA05-HP358	30802726
12,70	14	124	77	60	45	SCD601-1270-2-2-140HA05-HP358	30802727
12,80	14	124	77	60	45	SCD601-1280-2-2-140HA05-HP358	30802728
12,90	14	124	77	60	45	SCD601-1290-2-2-140HA05-HP358	30802729
13,00	14	124	77	60	45	SCD601-1300-2-2-140HA05-HP358	30802730
13,10	14	124	77	60	45	SCD601-1310-2-2-140HA05-HP358	30802731
13,30	14	124	77	60	45	SCD601-1330-2-2-140HA05-HP358	30802732
13,35	14	124	77	60	45	SCD601-1335-2-2-140HA05-HP358	30802733
13,50	14	124	77	60	45	SCD601-1350-2-2-140HA05-HP358	30802734
13,70	14	124	77	60	45	SCD601-1370-2-2-140HA05-HP358	30802735
13,80	14	124	77	60	45	SCD601-1380-2-2-140HA05-HP358	30802736
14,00	14	124	77	60	45	SCD601-1400-2-2-140HA05-HP358	30802737
14,20	16	133	83	63	48	SCD601-1420-2-2-140HA05-HP358	30802738
14,50	16	133	83	63	48	SCD601-1450-2-2-140HA05-HP358	30802739
14,80	16	133	83	63	48	SCD601-1480-2-2-140HA05-HP358	30802740
15,00	16	133	83	63	48	SCD601-1500-2-2-140HA05-HP358	30802741
15,10	16	133	83	63	48	SCD601-1510-2-2-140HA05-HP358	30802742
15,25	16	133	83	63	48	SCD601-1525-2-2-140HA05-HP358	30802743
15,30	16	133	83	63	48	SCD601-1530-2-2-140HA05-HP358	30802744
15,35	16	133	83	63	48	SCD601-1535-2-2-140HA05-HP358	30802745
15,50	16	133	83	63	48	SCD601-1550-2-2-140HA05-HP358	30802746
15,60	16	133	83	63	48	SCD601-1560-2-2-140HA05-HP358	30802747
15,80	16	133	83	63	48	SCD601-1580-2-2-140HA05-HP358	30802748
16,00	16	133	83	63	48	SCD601-1600-2-2-140HA05-HP358	30802749
16,05	18	143	93	71	48	SCD601-1605-2-2-140HA05-HP358	30802750
16,50	18	143	93	71	48	SCD601-1650-2-2-140HA05-HP358	30802751
16,80	18	143	93	71	48	SCD601-1680-2-2-140HA05-HP358	30802752
16,90	18	143	93	71	48	SCD601-1690-2-2-140HA05-HP358	30802753
17,00	18	143	93	71	48	SCD601-1700-2-2-140HA05-HP358	30802754

Continúa en la página siguiente.

MEGA-Drill-Steel-Plus | Broca helicoidal de metal duro SCD601 (5xD), suministro de refrigerante interior

Características configurables

**Diámetro:**

Diámetro seleccionable libremente en incrementos de 0,01 mm

**Forma del mango:**

Forma del mango: HB | HE

Especificación

SCD601-[diámetro]-3-3-140[forma del mango]05-HP358

Ejemplo:

SCD601-0431-3-3-140HE05-HP358

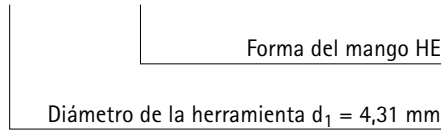

Dimensiones de la serie configurable

d ₁ min.	d ₁ max.	d ₂ h6	l ₁	l ₂	l ₃	l ₄
3,00	3,70	6	66	28	23	36
3,71	4,70	6	74	36	29	36
4,71	6,00	6	82	44	35	36
6,01	8,00	8	91	53	43	36
8,01	10,00	10	103	61	49	40
10,01	12,00	12	118	71	56	45
12,01	14,00	14	124	77	60	45
14,01	16,00	16	133	83	63	48
16,01	18,00	18	143	93	71	48
18,01	20,00	20	153	101	77	50
20,01	22,00	25	200	135	110	56
22,01	25,00	25	200	140	120	56

Medidas en mm.

* Especialmente indicada para la prefabricación de los agujeros para rosca para machos de laminación.

Para la recomendación de valores de corte, véase al final del capítulo.

Ejecuciones especiales y otros recubrimientos a petición.

MEGA-Drill-Steel-Plus

Broca helicoidal de metal duro

SCD601 (8xD), suministro de refrigerante interior, producto sucesor de la MEGA-Drill-Steel (SCD10)

Ejecución:

Diámetro de broca: 3,00 – 20,00 mm
 Tolerancia del agujero: ≥ IT 9
 Material de corte: HP358
 Número de insertos: 2
 Número de biseles guía: 2
 Ángulo de la punta: 135°
 Ángulo de hélice: 30°

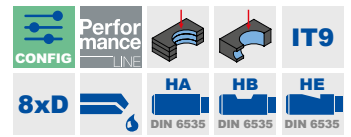
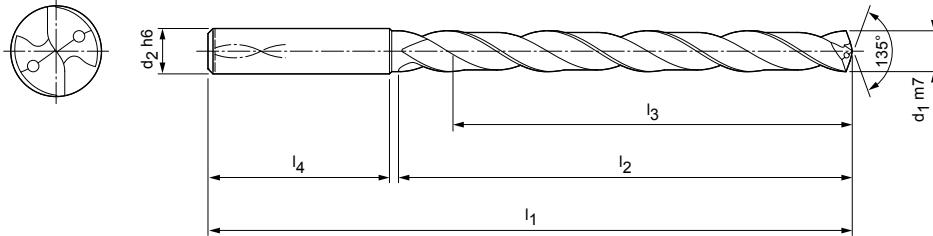

Serie preferente disponible en stock en forma de mango HA

Dimensiones						Forma del mango HA	
d ₁ m7	d ₂ h6	l ₁	l ₂	l ₃	l ₄	Especificación	Referencia
3,00	6	72	34	29	36	SCD601-0300-2-2-135HA08-HP358	30803112
3,10	6	72	34	29	36	SCD601-0310-2-2-135HA08-HP358	30803113
3,20	6	72	34	29	36	SCD601-0320-2-2-135HA08-HP358	30803114
3,30	6	72	34	29	36	SCD601-0330-2-2-135HA08-HP358	30803115
3,40	6	72	34	29	36	SCD601-0340-2-2-135HA08-HP358	30803116
3,50	6	72	34	29	36	SCD601-0350-2-2-135HA08-HP358	30803117
3,60	6	72	34	29	36	SCD601-0360-2-2-135HA08-HP358	30803118
3,70	6	72	34	29	36	SCD601-0370-2-2-135HA08-HP358	30803119
3,80	6	81	43	36	36	SCD601-0380-2-2-135HA08-HP358	30803120
3,90	6	81	43	36	36	SCD601-0390-2-2-135HA08-HP358	30803121
4,00	6	81	43	36	36	SCD601-0400-2-2-135HA08-HP358	30803122
4,10	6	81	43	36	36	SCD601-0410-2-2-135HA08-HP358	30803123
4,20	6	81	43	36	36	SCD601-0420-2-2-135HA08-HP358	30803124
4,30	6	81	43	36	36	SCD601-0430-2-2-135HA08-HP358	30803125
4,40	6	81	43	36	36	SCD601-0440-2-2-135HA08-HP358	30803126
4,50	6	81	43	36	36	SCD601-0450-2-2-135HA08-HP358	30803127
4,60	6	81	43	36	36	SCD601-0460-2-2-135HA08-HP358	30803128
4,70	6	81	43	36	36	SCD601-0470-2-2-135HA08-HP358	30803129
4,80	6	95	57	48	36	SCD601-0480-2-2-135HA08-HP358	30803130
4,90	6	95	57	48	36	SCD601-0490-2-2-135HA08-HP358	30803131
5,00	6	95	57	48	36	SCD601-0500-2-2-135HA08-HP358	30803132
5,10	6	95	57	48	36	SCD601-0510-2-2-135HA08-HP358	30803133
5,20	6	95	57	48	36	SCD601-0520-2-2-135HA08-HP358	30803134
5,30	6	95	57	48	36	SCD601-0530-2-2-135HA08-HP358	30803135
5,40	6	95	57	48	36	SCD601-0540-2-2-135HA08-HP358	30803136
5,50	6	95	57	48	36	SCD601-0550-2-2-135HA08-HP358	30803137
5,60	6	95	57	48	36	SCD601-0560-2-2-135HA08-HP358	30803138
5,70	6	95	57	48	36	SCD601-0570-2-2-135HA08-HP358	30803139
5,80	6	95	57	48	36	SCD601-0580-2-2-135HA08-HP358	30803140
5,90	6	95	57	48	36	SCD601-0590-2-2-135HA08-HP358	30803141
6,00	6	95	57	48	36	SCD601-0600-2-2-135HA08-HP358	30803142
6,10	8	114	76	64	36	SCD601-0610-2-2-135HA08-HP358	30803143
6,20	8	114	76	64	36	SCD601-0620-2-2-135HA08-HP358	30803144
6,30	8	114	76	64	36	SCD601-0630-2-2-135HA08-HP358	30803145
6,40	8	114	76	64	36	SCD601-0640-2-2-135HA08-HP358	30803146

MEGA-Drill-Steel-Plus | Broca helicoidal de metal duro SCD601 (8xD), suministro de refrigerante interior

Dimensiones						Forma del mango HA	
d ₁ m7	d ₂ h6	l ₁	l ₂	l ₃	l ₄	Especificación	Referencia
6,50	8	114	76	64	36	SCD601-0650-2-2-135HA08-HP358	30803147
6,60	8	114	76	64	36	SCD601-0660-2-2-135HA08-HP358	30803148
6,70	8	114	76	64	36	SCD601-0670-2-2-135HA08-HP358	30803149
6,80	8	114	76	64	36	SCD601-0680-2-2-135HA08-HP358	30803150
6,90	8	114	76	64	36	SCD601-0690-2-2-135HA08-HP358	30803151
7,00	8	114	76	64	36	SCD601-0700-2-2-135HA08-HP358	30803152
7,10	8	114	76	64	36	SCD601-0710-2-2-135HA08-HP358	30803153
7,20	8	114	76	64	36	SCD601-0720-2-2-135HA08-HP358	30803154
7,30	8	114	76	64	36	SCD601-0730-2-2-135HA08-HP358	30803155
7,40	8	114	76	64	36	SCD601-0740-2-2-135HA08-HP358	30803156
7,50	8	114	76	64	36	SCD601-0750-2-2-135HA08-HP358	30803157
7,60	8	114	76	64	36	SCD601-0760-2-2-135HA08-HP358	30803158
7,70	8	114	76	64	36	SCD601-0770-2-2-135HA08-HP358	30803159
7,80	8	114	76	64	36	SCD601-0780-2-2-135HA08-HP358	30803160
7,90	8	114	76	64	36	SCD601-0790-2-2-135HA08-HP358	30803161
8,00	8	114	76	64	36	SCD601-0800-2-2-135HA08-HP358	30803162
8,10	10	142	95	80	40	SCD601-0810-2-2-135HA08-HP358	30803163
8,20	10	142	95	80	40	SCD601-0820-2-2-135HA08-HP358	30803164
8,40	10	142	95	80	40	SCD601-0840-2-2-135HA08-HP358	30803166
8,50	10	142	95	80	40	SCD601-0850-2-2-135HA08-HP358	30803167
8,60	10	142	95	80	40	SCD601-0860-2-2-135HA08-HP358	30803168
8,70	10	142	95	80	40	SCD601-0870-2-2-135HA08-HP358	30803169
8,80	10	142	95	80	40	SCD601-0880-2-2-135HA08-HP358	30803170
8,90	10	142	95	80	40	SCD601-0890-2-2-135HA08-HP358	30803171
9,00	10	142	95	80	40	SCD601-0900-2-2-135HA08-HP358	30803172
9,10	10	142	95	80	40	SCD601-0910-2-2-135HA08-HP358	30803173
9,20	10	142	95	80	40	SCD601-0920-2-2-135HA08-HP358	30803174
9,30	10	142	95	80	40	SCD601-0930-2-2-135HA08-HP358	30803175
9,40	10	142	95	80	40	SCD601-0940-2-2-135HA08-HP358	30803176
9,50	10	142	95	80	40	SCD601-0950-2-2-135HA08-HP358	30803177
9,60	10	142	95	80	40	SCD601-0960-2-2-135HA08-HP358	30803178
9,80	10	142	95	80	40	SCD601-0980-2-2-135HA08-HP358	30803180
9,90	10	142	95	80	40	SCD601-0990-2-2-135HA08-HP358	30803181
10,00	10	142	95	80	40	SCD601-1000-2-2-135HA08-HP358	30803182
10,10	12	162	114	96	45	SCD601-1010-2-2-135HA08-HP358	30803183
10,20	12	162	114	96	45	SCD601-1020-2-2-135HA08-HP358	30803184
10,30	12	162	114	95	45	SCD601-1030-2-2-135HA08-HP358	30803185
10,40	12	162	114	96	45	SCD601-1040-2-2-135HA08-HP358	30803186
10,50	12	162	114	96	45	SCD601-1050-2-2-135HA08-HP358	30803187
10,70	12	162	114	96	45	SCD601-1070-2-2-135HA08-HP358	30803189
10,80	12	162	114	96	45	SCD601-1080-2-2-135HA08-HP358	30803190
11,00	12	162	114	96	45	SCD601-1100-2-2-135HA08-HP358	30803192
11,10	12	162	114	96	45	SCD601-1110-2-2-135HA08-HP358	30803193
11,20	12	162	114	96	45	SCD601-1120-2-2-135HA08-HP358	30803194
11,30	12	162	114	96	45	SCD601-1130-2-2-135HA08-HP358	30803195
11,40	12	162	114	96	45	SCD601-1140-2-2-135HA08-HP358	30803196
11,50	12	162	114	96	45	SCD601-1150-2-2-135HA08-HP358	30803197
11,80	12	162	114	96	45	SCD601-1180-2-2-135HA08-HP358	30803200
12,00	12	162	114	96	45	SCD601-1200-2-2-135HA08-HP358	30803202
12,50	14	178	133	112	45	SCD601-1250-2-2-135HA08-HP358	30803203
12,80	14	178	133	112	45	SCD601-1280-2-2-135HA08-HP358	30803204
13,00	14	178	133	112	45	SCD601-1300-2-2-135HA08-HP358	30803205
13,50	14	178	133	112	45	SCD601-1350-2-2-135HA08-HP358	30803206
13,80	14	178	133	112	45	SCD601-1380-2-2-135HA08-HP358	30803207
14,00	14	178	133	112	45	SCD601-1400-2-2-135HA08-HP358	30803208
14,50	16	203	152	128	48	SCD601-1450-2-2-135HA08-HP358	30803209
14,80	16	203	152	128	48	SCD601-1480-2-2-135HA08-HP358	30803210

MEGA-Drill-Steel-Plus | Broca helicoidal de metal duro SCD601 (8xD), suministro de refrigerante interior

Dimensiones						Forma del mango HA	
d ₁ m7	d ₂ h6	l ₁	l ₂	l ₃	l ₄	Especificación	Referencia
15,00	16	203	152	128	48	SCD601-1500-2-2-135HA08-HP358	30803211
15,50	16	203	152	128	48	SCD601-1550-2-2-135HA08-HP358	30803212
15,80	16	203	152	128	48	SCD601-1580-2-2-135HA08-HP358	30803213
16,00	16	203	152	128	48	SCD601-1600-2-2-135HA08-HP358	30803214
17,00	18	222	171	144	48	SCD601-1700-2-2-135HA08-HP358	30803217
17,50	18	222	171	144	48	SCD601-1750-2-2-135HA08-HP358	30803218
17,80	18	222	171	144	48	SCD601-1780-2-2-135HA08-HP358	30803219
18,00	18	222	171	144	48	SCD601-1800-2-2-135HA08-HP358	30803220
18,50	20	243	190	160	50	SCD601-1850-2-2-135HA08-HP358	30803221
18,80	20	243	190	160	50	SCD601-1880-2-2-135HA08-HP358	30803222
19,50	20	243	190	160	50	SCD601-1950-2-2-135HA08-HP358	30803224
19,80	20	243	190	160	50	SCD601-1980-2-2-135HA08-HP358	30803225
20,00	20	243	190	160	50	SCD601-2000-2-2-135HA08-HP358	30803226

Características configurables

**Diámetro:**

Diámetro seleccionable libremente en incrementos de 0,01 mm

**Forma del mango:**

Forma del mango: HB | HE

Especificación

SCD601-[diámetro]-2-2-135[forma del mango]08-HP358

Dimensiones de la serie configurable

d ₁ min.	d ₁ max.	d ₂ h6	l ₁	l ₂	l ₃	l ₄
3,00	3,70	6	72	34	29	36
3,71	4,70	6	81	43	36	36
4,71	6,00	6	95	57	48	36
6,01	8,00	8	114	76	64	36
8,01	10,00	10	142	95	80	40
10,01	12,00	12	162	114	96	45
12,01	14,00	14	178	133	112	45
14,01	16,00	16	203	152	128	48
16,01	18,00	18	222	171	144	48
18,01	20,00	20	243	190	160	50

Ejemplo:

SCD601-0431-2-2-135HE08-HP358

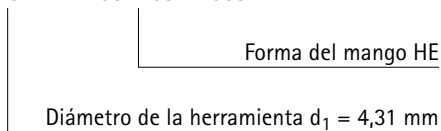

Medidas en mm.

Para la recomendación de valores de corte, véase al final del capítulo.

Ejecuciones especiales y otros recubrimientos a petición.

MEGA-Quadro-Drill-Plus

Broca helicoidal de metal duro

SCD610 (5xD), suministro de refrigerante exterior, producto sucesor de la MEGA-Quadro-Drill (SCD16)

Ejecución:

Diámetro de broca:	3,00 – 20,00 mm
Tolerancia del agujero:	≥ IT 8
Material de corte:	HP358
Número de insertos:	2
Número de bisel guía:	4
Ángulo de la punta:	140°
Ángulo de hélice:	30°

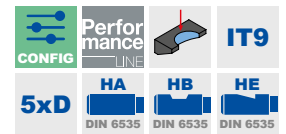
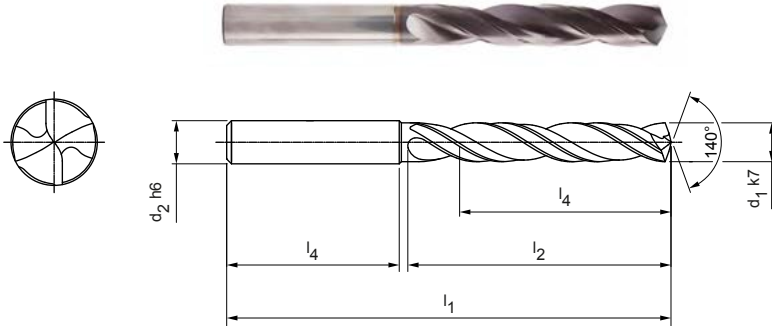

Serie preferente disponible en stock en forma de mango HA

Dimensiones						Forma del mango HA	
d ₁ k7	d ₂ h6	l ₁	l ₂	l ₃	l ₄	Especificación	Referencia
3,00	6	66	28	23	36	SCD610-0300-2-4-140HA05-HP358	31052631
3,10	6	66	28	23	36	SCD610-0310-2-4-140HA05-HP358	31052632
3,20	6	66	28	23	36	SCD610-0320-2-4-140HA05-HP358	31052633
3,30	6	66	28	23	36	SCD610-0330-2-4-140HA05-HP358	31052634
3,40	6	66	28	23	36	SCD610-0340-2-4-140HA05-HP358	31052635
3,50	6	66	28	23	36	SCD610-0350-2-4-140HA05-HP358	31052636
3,70	6	66	28	23	36	SCD610-0370-2-4-140HA05-HP358	31052638
4,00	6	74	36	29	36	SCD610-0400-2-4-140HA05-HP358	31052641
4,20	6	74	36	29	36	SCD610-0420-2-4-140HA05-HP358	31052643
4,30	6	74	36	29	36	SCD610-0430-2-4-140HA05-HP358	31052644
4,50	6	74	36	29	36	SCD610-0450-2-4-140HA05-HP358	31052646
4,80	6	82	44	35	36	SCD610-0480-2-4-140HA05-HP358	31052649
5,00	6	82	44	35	36	SCD610-0500-2-4-140HA05-HP358	31052651
5,10	6	82	44	35	36	SCD610-0510-2-4-140HA05-HP358	31052652
5,20	6	82	44	35	36	SCD610-0520-2-4-140HA05-HP358	31052653
5,50	6	82	44	35	36	SCD610-0550-2-4-140HA05-HP358	31052656
5,60	6	82	44	35	36	SCD610-0560-2-4-140HA05-HP358	31052657
5,80	6	82	44	35	36	SCD610-0580-2-4-140HA05-HP358	31052659
6,00	6	82	44	35	36	SCD610-0600-2-4-140HA05-HP358	31052661
6,40	8	91	53	43	36	SCD610-0640-2-4-140HA05-HP358	31052665
6,50	8	91	53	43	36	SCD610-0650-2-4-140HA05-HP358	31052666
6,80	8	91	53	43	36	SCD610-0680-2-4-140HA05-HP358	31052669
6,90	8	91	53	43	36	SCD610-0690-2-4-140HA05-HP358	31052670
7,00	8	91	53	43	36	SCD610-0700-2-4-140HA05-HP358	31052671
7,40	8	91	53	43	36	SCD610-0740-2-4-140HA05-HP358	31052675
7,50	8	91	53	43	36	SCD610-0750-2-4-140HA05-HP358	31052676
7,80	8	91	53	43	36	SCD610-0780-2-4-140HA05-HP358	31052679
8,00	8	91	53	43	36	SCD610-0800-2-4-140HA05-HP358	31052681
8,50	10	103	61	49	40	SCD610-0850-2-4-140HA05-HP358	31052686
8,60	10	103	61	49	40	SCD610-0860-2-4-140HA05-HP358	31052687
8,80	10	103	61	49	40	SCD610-0880-2-4-140HA05-HP358	31052689
9,00	10	103	61	49	40	SCD610-0900-2-4-140HA05-HP358	31052691
9,50	10	103	61	49	40	SCD610-0950-2-4-140HA05-HP358	31052696
9,80	10	103	61	49	40	SCD610-0980-2-4-140HA05-HP358	31052699
10,00	10	103	61	49	40	SCD610-1000-2-4-140HA05-HP358	31052701

MEGA-Quadro-Drill-Plus | Broca helicoidal de metal duro SCD610 (5xD), suministro de refrigerante exterior

Dimensiones						Forma del mango HA	
d ₁ k7	d ₂ h6	l ₁	l ₂	l ₃	l ₄	Especificación	Referencia
10,20	12	118	71	56	45	SCD610-1020-2-4-140HA05-HP358	31052703
10,30	12	118	71	56	45	SCD610-1030-2-4-140HA05-HP358	31052704
10,50	12	118	71	56	45	SCD610-1050-2-4-140HA05-HP358	31052706
10,90	12	118	71	56	45	SCD610-1090-2-4-140HA05-HP358	31052710
11,00	12	118	71	56	45	SCD610-1100-2-4-140HA05-HP358	31052711
11,50	12	118	71	56	45	SCD610-1150-2-4-140HA05-HP358	31052716
11,80	12	118	71	56	45	SCD610-1180-2-4-140HA05-HP358	31052719
12,00	12	118	71	56	45	SCD610-1200-2-4-140HA05-HP358	31052721
12,50	14	124	77	60	45	SCD610-1250-2-4-140HA05-HP358	31052722
13,00	14	124	77	60	45	SCD610-1300-2-4-140HA05-HP358	31052724
13,50	14	124	77	60	45	SCD610-1350-2-4-140HA05-HP358	31052725
14,00	14	124	77	60	45	SCD610-1400-2-4-140HA05-HP358	31052727
14,50	16	133	83	63	48	SCD610-1450-2-4-140HA05-HP358	31052728
15,00	16	133	83	63	48	SCD610-1500-2-4-140HA05-HP358	31052730
16,00	16	133	83	63	48	SCD610-1600-2-4-140HA05-HP358	31052733
17,00	18	143	93	71	48	SCD610-1700-2-4-140HA05-HP358	31052736
17,50	18	143	93	71	48	SCD610-1750-2-4-140HA05-HP358	31052737
18,00	18	143	93	71	48	SCD610-1800-2-4-140HA05-HP358	31052739
18,50	20	153	101	77	50	SCD610-1850-2-4-140HA05-HP358	31052740
20,00	20	153	101	77	50	SCD610-2000-2-4-140HA05-HP358	31052745

Características configurables

**Diámetro:**

Diámetro seleccionable libremente en incrementos de 0,01 mm

**Forma del mango:**

Forma del mango: HB | HE

Especificación

SCD610-[diámetro]-3-3-140[forma del mango]05-HP358

Dimensiones de la serie configurable

d ₁ min.	d ₁ max.	d ₂ h6	l ₁	l ₂	l ₃	l ₄
3,00	3,70	6	66	28	23	36
3,71	4,70	6	74	36	29	36
4,71	6,00	6	82	44	35	36
6,01	8,00	8	91	53	43	36
8,01	10,00	10	103	61	49	40
10,01	12,00	12	118	71	56	45
12,01	14,00	14	124	77	60	45
14,01	16,00	16	133	83	63	48
16,01	18,00	18	143	93	71	48
18,01	20,00	20	153	101	77	50

Ejemplo:

SCD610-0431-3-3-140HE05-HP358

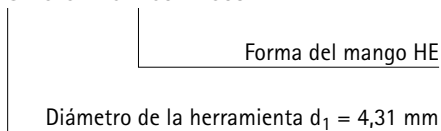

Mediciones in mm.

Para la información de medidas consulte el capítulo.

Especialmente para los brocas de metal duro.

MEGA-Quadro-Drill-Plus

Broca helicoidal de metal duro

SCD611 (5xD), suministro de refrigerante interior, producto sucesor de la MEGA-Quadro-Drill (SCD16)

Ejecución:

Diámetro de broca:	3,00 – 20,00 mm
Tolerancia del agujero:	≥ IT 8
Material de corte:	HP358
Número de insertos:	2
Número de bisel guía:	4
Ángulo de la punta:	140°
Ángulo de hélice:	30°

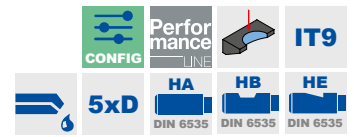
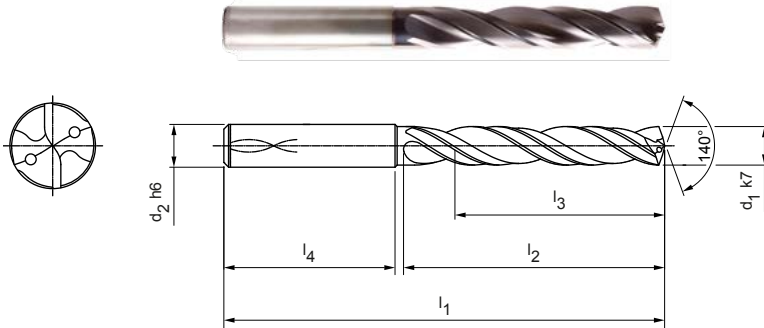

Serie preferente disponible en stock en forma de mango HA

Dimensiones						Forma del mango HA	
d ₁ k7	d ₂ h6	l ₁	l ₂	l ₃	l ₄	Especificación	Referencia
3,00	6	66	28	23	36	SCD611-0300-2-4-140HA05-HP358	31052795
3,10	6	66	28	23	36	SCD611-0310-2-4-140HA05-HP358	31052796
3,20	6	66	28	23	36	SCD611-0320-2-4-140HA05-HP358	31052797
3,30	6	66	28	23	36	SCD611-0330-2-4-140HA05-HP358	31052798
3,40	6	66	28	23	36	SCD611-0340-2-4-140HA05-HP358	31052799
3,50	6	66	28	23	36	SCD611-0350-2-4-140HA05-HP358	31052800
3,70	6	66	28	23	36	SCD611-0370-2-4-140HA05-HP358	31052802
3,80	6	74	36	29	36	SCD611-0380-2-4-140HA05-HP358	31052803
3,90	6	74	36	29	36	SCD611-0390-2-4-140HA05-HP358	31052804
4,00	6	74	36	29	36	SCD611-0400-2-4-140HA05-HP358	31052805
4,20	6	74	36	29	36	SCD611-0420-2-4-140HA05-HP358	31052807
4,30	6	74	36	29	36	SCD611-0430-2-4-140HA05-HP358	31052808
4,50	6	74	36	29	36	SCD611-0450-2-4-140HA05-HP358	31052810
4,80	6	82	44	35	36	SCD611-0480-2-4-140HA05-HP358	31052813
5,00	6	82	44	35	36	SCD611-0500-2-4-140HA05-HP358	31052815
5,10	6	82	44	35	36	SCD611-0510-2-4-140HA05-HP358	31052816
5,20	6	82	44	35	36	SCD611-0520-2-4-140HA05-HP358	31052817
5,30	6	82	44	35	36	SCD611-0530-2-4-140HA05-HP358	31052818
5,50	6	82	44	35	36	SCD611-0550-2-4-140HA05-HP358	31052820
5,60	6	82	44	35	36	SCD611-0560-2-4-140HA05-HP358	31052821
5,80	6	82	44	35	36	SCD611-0580-2-4-140HA05-HP358	31052823
5,90	6	82	44	35	36	SCD611-0590-2-4-140HA05-HP358	31052824
6,00	6	82	44	35	36	SCD611-0600-2-4-140HA05-HP358	31052825
6,40	8	91	53	43	36	SCD611-0640-2-4-140HA05-HP358	31052829
6,50	8	91	53	43	36	SCD611-0650-2-4-140HA05-HP358	31052830
6,60	8	91	53	43	36	SCD611-0660-2-4-140HA05-HP358	31052831
6,70	8	91	53	43	36	SCD611-0670-2-4-140HA05-HP358	31052832
6,80	8	91	53	43	36	SCD611-0680-2-4-140HA05-HP358	31052833
6,90	8	91	53	43	36	SCD611-0690-2-4-140HA05-HP358	31052834
7,00	8	91	53	43	36	SCD611-0700-2-4-140HA05-HP358	31052835
7,20	8	91	53	43	36	SCD611-0720-2-4-140HA05-HP358	31052837
7,40	8	91	53	43	36	SCD611-0740-2-4-140HA05-HP358	31052839
7,50	8	91	53	43	36	SCD611-0750-2-4-140HA05-HP358	31052840
7,80	8	91	53	43	36	SCD611-0780-2-4-140HA05-HP358	31052843
7,90	8	91	53	43	36	SCD611-0790-2-4-140HA05-HP358	31052844

MEGA-Quadro-Drill-Plus | Broca helicoidal de metal duro SCD611 (5xD), suministro de refrigerante interior

Dimensiones						Forma del mango HA	
d ₁ k7	d ₂ h6	l ₁	l ₂	l ₃	l ₄	Especificación	Referencia
8,00	8	91	53	43	36	SCD611-0800-2-4-140HA05-HP358	31052845
8,10	10	103	61	49	40	SCD611-0810-2-4-140HA05-HP358	31052846
8,30	10	103	61	49	40	SCD611-0830-2-4-140HA05-HP358	31052848
8,40	10	103	61	49	40	SCD611-0840-2-4-140HA05-HP358	31052849
8,50	10	103	61	49	40	SCD611-0850-2-4-140HA05-HP358	31052850
8,60	10	103	61	49	40	SCD611-0860-2-4-140HA05-HP358	31052851
8,80	10	103	61	49	40	SCD611-0880-2-4-140HA05-HP358	31052853
9,00	10	103	61	49	40	SCD611-0900-2-4-140HA05-HP358	31052855
9,20	10	103	61	49	40	SCD611-0920-2-4-140HA05-HP358	31052857
9,30	10	103	61	49	40	SCD611-0930-2-4-140HA05-HP358	31052858
9,50	10	103	61	49	40	SCD611-0950-2-4-140HA05-HP358	31052860
9,80	10	103	61	49	40	SCD611-0980-2-4-140HA05-HP358	31052863
9,90	10	103	61	49	40	SCD611-0990-2-4-140HA05-HP358	31052864
10,00	10	103	61	49	40	SCD611-1000-2-4-140HA05-HP358	31052865
10,20	12	118	71	56	45	SCD611-1020-2-4-140HA05-HP358	31052867
10,30	12	118	71	56	45	SCD611-1030-2-4-140HA05-HP358	31052868
10,40	12	118	71	56	45	SCD611-1040-2-4-140HA05-HP358	31052869
10,50	12	118	71	56	45	SCD611-1050-2-4-140HA05-HP358	31052870
10,90	12	118	71	56	45	SCD611-1090-2-4-140HA05-HP358	31052874
11,00	12	118	71	56	45	SCD611-1100-2-4-140HA05-HP358	31052875
11,50	12	118	71	56	45	SCD611-1150-2-4-140HA05-HP358	31052880
11,70	12	118	71	56	45	SCD611-1170-2-4-140HA05-HP358	31052882
11,80	12	118	71	56	45	SCD611-1180-2-4-140HA05-HP358	31052883

Características configurables

**Diámetro:**

Diámetro seleccionable libremente en incrementos de 0,01 mm

**Forma del mango:**

Forma del mango: HB | HE

Especificación

SCD611-[diámetro]-3-3-140[forma del mango]05-HP358

Dimensiones de la serie configurable

d ₁ min.	d ₁ max.	d ₂ h6	l ₁	l ₂	l ₃	l ₄
3,00	3,70	6	66	28	23	36
3,71	4,70	6	74	36	29	36
4,71	6,00	6	82	44	35	36
6,01	8,00	8	91	53	43	36
8,01	10,00	10	103	61	49	40
10,01	12,00	12	118	71	56	45
12,01	14,00	14	124	77	60	45
14,01	16,00	16	133	83	63	48
16,01	18,00	18	143	93	71	48
18,01	20,00	20	153	101	77	50

Ejemplo:

SCD611-0431-3-3-140HE05-HP358

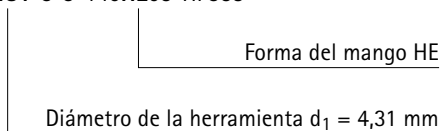

Medidas en mm.

Para la recomendación de valores de corte, véase al final del capítulo.

Ejecuciones especiales y otros recubrimientos a petición.

MEGA-Quadro-Drill-Plus

Broca helicoidal de metal duro

SCD611 (8xD), suministro de refrigerante interior, producto sucesor de la MEGA-Quadro-Drill (SCD16)

Ejecución:

Diámetro de broca: 3,00 – 20,00 mm
 Tolerancia del agujero: \geq IT 8
 Material de corte: HP358
 Número de insertos: 2
 Número de biseles guía: 4
 Ángulo de la punta: 140°
 Ángulo de hélice: 30°

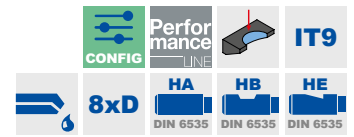
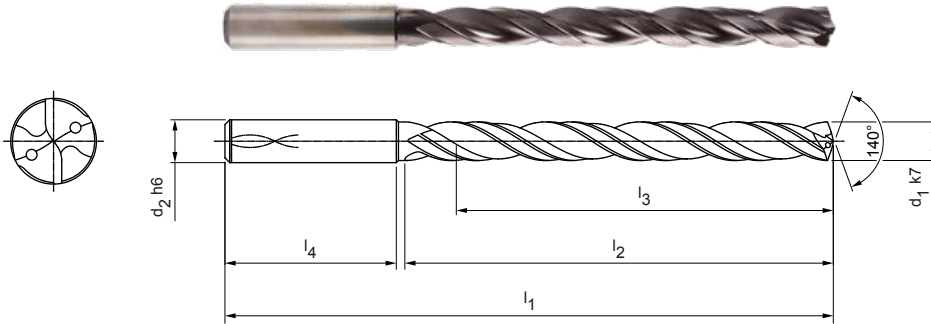

Serie preferente disponible en stock en forma de mango HA

Dimensiones						Forma del mango HA	
d ₁ k7	d ₂ h6	l ₁	l ₂	l ₃	l ₄	Especificación	Referencia
3,00	6	72	34	29	36	SCD611-0300-2-4-140HA08-HP358	31052910
3,10	6	72	34	29	36	SCD611-0310-2-4-140HA08-HP358	31052911
3,20	6	72	34	29	36	SCD611-0320-2-4-140HA08-HP358	31052912
3,30	6	72	34	29	36	SCD611-0330-2-4-140HA08-HP358	31052913
3,40	6	72	34	29	36	SCD611-0340-2-4-140HA08-HP358	31052914
3,50	6	72	34	29	36	SCD611-0350-2-4-140HA08-HP358	31052915
3,60	6	72	34	29	36	SCD611-0360-2-4-140HA08-HP358	31052916
3,70	6	72	34	29	36	SCD611-0370-2-4-140HA08-HP358	31052917
3,80	6	81	43	36	36	SCD611-0380-2-4-140HA08-HP358	31052918
3,90	6	81	43	36	36	SCD611-0390-2-4-140HA08-HP358	31052919
4,00	6	81	43	36	36	SCD611-0400-2-4-140HA08-HP358	31052920
4,10	6	81	43	36	36	SCD611-0410-2-4-140HA08-HP358	31052921
4,20	6	81	43	36	36	SCD611-0420-2-4-140HA08-HP358	31052922
4,30	6	81	43	36	36	SCD611-0430-2-4-140HA08-HP358	31052923
4,40	6	81	43	36	36	SCD611-0440-2-4-140HA08-HP358	31052924
4,50	6	81	43	36	36	SCD611-0450-2-4-140HA08-HP358	31052925
4,60	6	81	43	36	36	SCD611-0460-2-4-140HA08-HP358	31052926
4,80	6	95	57	48	36	SCD611-0480-2-4-140HA08-HP358	31052928
4,90	6	95	57	48	36	SCD611-0490-2-4-140HA08-HP358	31052929
5,00	6	95	57	48	36	SCD611-0500-2-4-140HA08-HP358	31052930
5,10	6	95	57	48	36	SCD611-0510-2-4-140HA08-HP358	31052931
5,20	6	95	57	48	36	SCD611-0520-2-4-140HA08-HP358	31052932
5,40	6	95	57	48	36	SCD611-0540-2-4-140HA08-HP358	31052934
5,50	6	95	57	48	36	SCD611-0550-2-4-140HA08-HP358	31052935
5,60	6	95	57	48	36	SCD611-0560-2-4-140HA08-HP358	31052936
5,70	6	95	57	48	36	SCD611-0570-2-4-140HA08-HP358	31052937
5,80	6	95	57	48	36	SCD611-0580-2-4-140HA08-HP358	31052938
6,00	6	95	57	48	36	SCD611-0600-2-4-140HA08-HP358	31052940
6,10	8	114	76	64	36	SCD611-0610-2-4-140HA08-HP358	31052941
6,20	8	114	76	64	36	SCD611-0620-2-4-140HA08-HP358	31052942
6,50	8	114	76	64	36	SCD611-0650-2-4-140HA08-HP358	31052945
6,60	8	114	76	64	36	SCD611-0660-2-4-140HA08-HP358	31052946
6,80	8	114	76	64	36	SCD611-0680-2-4-140HA08-HP358	31052948
6,90	8	114	76	64	36	SCD611-0690-2-4-140HA08-HP358	31052949
7,00	8	114	76	64	36	SCD611-0700-2-4-140HA08-HP358	31052950

MEGA-Quadro-Drill-Plus | Broca helicoidal de metal duro SCD611 (8xD), suministro de refrigerante interior

Dimensiones						Forma del mango HA	
d ₁ k7	d ₂ h6	l ₁	l ₂	l ₃	l ₄	Especificación	Referencia
7,20	8	114	76	64	36	SCD611-0720-2-4-140HA08-HP358	31052952
7,40	8	114	76	64	36	SCD611-0740-2-4-140HA08-HP358	31052954
7,50	8	114	76	64	36	SCD611-0750-2-4-140HA08-HP358	31052955
7,60	8	114	76	64	36	SCD611-0760-2-4-140HA08-HP358	31052956
7,80	8	114	76	64	36	SCD611-0780-2-4-140HA08-HP358	31052958
8,00	8	114	76	64	36	SCD611-0800-2-4-140HA08-HP358	31052960
8,20	10	142	95	80	40	SCD611-0820-2-4-140HA08-HP358	31052962
8,50	10	142	95	80	40	SCD611-0850-2-4-140HA08-HP358	31052965
8,60	10	142	95	80	40	SCD611-0860-2-4-140HA08-HP358	31052966
8,70	10	142	95	80	40	SCD611-0870-2-4-140HA08-HP358	31052967
8,90	10	142	95	80	40	SCD611-0890-2-4-140HA08-HP358	31052969
9,00	10	142	95	80	40	SCD611-0900-2-4-140HA08-HP358	31052970
9,50	10	142	95	80	40	SCD611-0950-2-4-140HA08-HP358	31052975
9,60	10	142	95	80	40	SCD611-0960-2-4-140HA08-HP358	31052976
9,70	10	142	95	80	40	SCD611-0970-2-4-140HA08-HP358	31052977
9,80	10	142	95	80	40	SCD611-0980-2-4-140HA08-HP358	31052978
9,90	10	142	95	80	40	SCD611-0990-2-4-140HA08-HP358	31052979
10,00	10	142	95	80	40	SCD611-1000-2-4-140HA08-HP358	31052980
10,10	12	162	114	96	45	SCD611-1010-2-4-140HA08-HP358	31052981
10,20	12	162	114	96	45	SCD611-1020-2-4-140HA08-HP358	31052982
10,50	12	162	114	96	45	SCD611-1050-2-4-140HA08-HP358	31052985
10,60	12	162	114	96	45	SCD611-1060-2-4-140HA08-HP358	31052986
10,70	12	162	114	96	45	SCD611-1070-2-4-140HA08-HP358	31052987
11,00	12	162	114	96	45	SCD611-1100-2-4-140HA08-HP358	31052990
11,30	12	162	114	96	45	SCD611-1130-2-4-140HA08-HP358	31052993
11,70	12	162	114	96	45	SCD611-1170-2-4-140HA08-HP358	31052997
11,80	12	162	114	96	45	SCD611-1180-2-4-140HA08-HP358	31052998
12,00	12	162	114	96	45	SCD611-1200-2-4-140HA08-HP358	31053000
12,50	14	178	133	112	45	SCD611-1250-2-4-140HA08-HP358	31053001
12,80	14	178	133	112	45	SCD611-1280-2-4-140HA08-HP358	31053002
13,00	14	178	133	112	45	SCD611-1300-2-4-140HA08-HP358	31053003
13,50	14	178	133	112	45	SCD611-1350-2-4-140HA08-HP358	31053004
14,00	14	178	133	112	45	SCD611-1400-2-4-140HA08-HP358	31053006
15,00	16	203	152	128	48	SCD611-1500-2-4-140HA08-HP358	31053009
15,80	16	203	152	128	48	SCD611-1580-2-4-140HA08-HP358	31053011
16,00	16	203	152	128	48	SCD611-1600-2-4-140HA08-HP358	31053012
16,50	18	222	171	144	48	SCD611-1650-2-4-140HA08-HP358	31053013
20,00	20	243	190	160	50	SCD611-2000-2-4-140HA08-HP358	31053024

Características configurables



Diámetro:
Diámetro seleccionable libremente en incrementos de 0,01 mm



Forma del mango:
Forma del mango: HB | HE

Especificación

SCD611-[diámetro]-3-3-140[forma del mango]08-HP358

Dimensiones de la serie configurable

d ₁ min.	d ₁ max.	d ₂ h6	l ₁	l ₂	l ₃	l ₄
3,00	3,70	6	72	34	29	36
3,71	4,70	6	81	43	36	36
4,71	6,00	6	95	57	48	36
6,01	8,00	8	114	76	64	36
8,01	10,00	10	142	95	80	40
10,01	12,00	12	162	114	96	45
12,01	14,00	14	178	133	112	45
14,01	16,00	16	203	152	128	48
16,01	18,00	18	222	171	144	48
18,01	20,00	20	243	190	160	50

Ejemplo:

SCD611-0431-2-4-140HE08-HP358

Forma del mango HE

Diámetro de la herramienta d₁ = 4,31 mm

Medidas en mm.

Para la recomendación de valores de corte, véase al final del capítulo.
Ejecuciones especiales y otros recubrimientos a petición.

MEGA-Quadro-Drill-Plus

Broca helicoidal de metal duro

SCD611 (12xD), suministro de refrigerante interior, producto sucesor de la MEGA-Quadro-Drill (SCD16)

Ejecución:

Diámetro de broca: 3,00 – 20,00 mm
 Tolerancia del agujero: \geq IT 8
 Material de corte: HP358
 Número de insertos: 2
 Número de bisel guía: 4
 Ángulo de la punta: 140°
 Ángulo de hélice: 30°

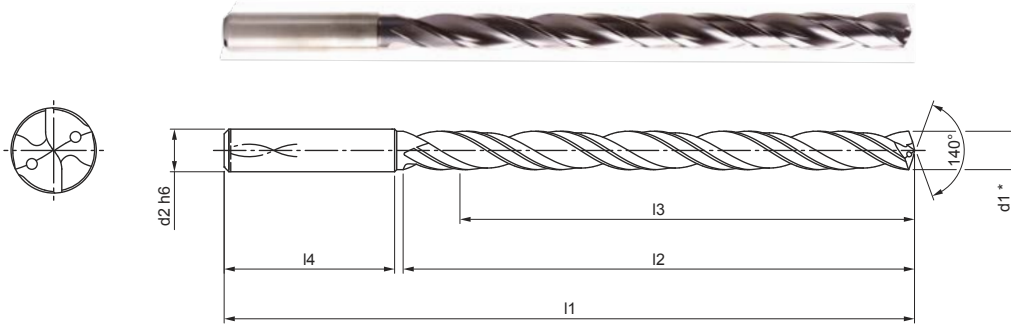

Serie preferente disponible en stock en forma de mango HA

Dimensiones						Forma del mango HA	
d_1 k7	d_2 h6	l_1	l_2	l_3	l_4	Especificación	Referencia
3,00	6	92	54	48	36	SCD611-0300-2-4-140HA12-HP358	31053025
3,10	6	92	54	48	36	SCD611-0310-2-4-140HA12-HP358	31053026
3,20	6	92	54	48	36	SCD611-0320-2-4-140HA12-HP358	31053027
3,30	6	92	54	48	36	SCD611-0330-2-4-140HA12-HP358	31053028
3,40	6	92	54	48	36	SCD611-0340-2-4-140HA12-HP358	31053029
3,50	6	92	54	48	36	SCD611-0350-2-4-140HA12-HP358	31053030
3,60	6	92	54	48	36	SCD611-0360-2-4-140HA12-HP358	31053031
3,70	6	92	54	48	36	SCD611-0370-2-4-140HA12-HP358	31053032
3,80	6	102	64	58	36	SCD611-0380-2-4-140HA12-HP358	31053033
3,90	6	102	64	58	36	SCD611-0390-2-4-140HA12-HP358	31053034
4,00	6	102	64	58	36	SCD611-0400-2-4-140HA12-HP358	31053035
4,05	6	102	64	58	36	SCD611-0405-2-4-140HA12-HP358	31300718
4,10	6	102	64	58	36	SCD611-0410-2-4-140HA12-HP358	31053036
4,20	6	102	64	58	36	SCD611-0420-2-4-140HA12-HP358	31053037
4,30	6	102	64	58	36	SCD611-0430-2-4-140HA12-HP358	31053038
4,40	6	102	64	58	36	SCD611-0440-2-4-140HA12-HP358	31053039
4,50	6	102	64	58	36	SCD611-0450-2-4-140HA12-HP358	31053040
4,60	6	102	64	58	36	SCD611-0460-2-4-140HA12-HP358	31053041
4,65	6	116	78	58	36	SCD611-0465-2-4-140HA12-HP358	31179333
4,70	6	102	64	58	36	SCD611-0470-2-4-140HA12-HP358	31053042
4,80	6	116	78	70	36	SCD611-0480-2-4-140HA12-HP358	31053043
5,00	6	116	78	70	36	SCD611-0500-2-4-140HA12-HP358	31053045
5,05	6	116	78	70	36	SCD611-0505-2-4-140HA12-HP358	31245107
5,10	6	116	78	70	36	SCD611-0510-2-4-140HA12-HP358	31053046
5,20	6	116	78	70	36	SCD611-0520-2-4-140HA12-HP358	31053047
5,40	6	116	78	70	36	SCD611-0540-2-4-140HA12-HP358	31053049
5,50	6	116	78	70	36	SCD611-0550-2-4-140HA12-HP358	31053050
5,60	6	116	78	70	36	SCD611-0560-2-4-140HA12-HP358	31053051
5,70	6	116	78	70	36	SCD611-0570-2-4-140HA12-HP358	31053052
5,80	6	116	78	70	36	SCD611-0580-2-4-140HA12-HP358	31053053
6,00	6	116	78	70	36	SCD611-0600-2-4-140HA12-HP358	31053055
6,10	8	146	108	94	36	SCD611-0610-2-4-140HA12-HP358	31053056
6,40	8	146	108	94	36	SCD611-0640-2-4-140HA12-HP358	31053059
6,50	8	146	108	94	36	SCD611-0650-2-4-140HA12-HP358	31053060
6,80	8	146	108	94	36	SCD611-0680-2-4-140HA12-HP358	31053063

MEGA-Quadro-Drill-Plus | Broca helicoidal de metal duro SCD611 (12xD), suministro de refrigerante interior

Dimensiones						Forma del mango HA	
d ₁ k7	d ₂ h6	l ₁	l ₂	l ₃	l ₄	Especificación	Referencia
6,90	8	146	108	94	36	SCD611-0690-2-4-140HA12-HP358	31053064
7,00	8	146	108	94	36	SCD611-0700-2-4-140HA12-HP358	31053065
7,10	8	146	108	94	36	SCD611-0710-2-4-140HA12-HP358	31053066
7,50	8	146	108	94	36	SCD611-0750-2-4-140HA12-HP358	31053070
7,60	8	146	108	94	36	SCD611-0760-2-4-140HA12-HP358	31053071
7,70	8	146	108	94	36	SCD611-0770-2-4-140HA12-HP358	31053072
7,80	8	146	108	94	36	SCD611-0780-2-4-140HA12-HP358	31053073
7,90	8	146	108	94	36	SCD611-0790-2-4-140HA12-HP358	31053074
8,00	8	146	108	94	36	SCD611-0800-2-4-140HA12-HP358	31053075
8,20	10	162	120	110	40	SCD611-0820-2-4-140HA12-HP358	31053077
8,30	10	162	120	110	40	SCD611-0830-2-4-140HA12-HP358	31053078
8,40	10	162	120	110	40	SCD611-0840-2-4-140HA12-HP358	31053079
8,50	10	162	120	110	40	SCD611-0850-2-4-140HA12-HP358	31053080
8,60	10	162	120	110	40	SCD611-0860-2-4-140HA12-HP358	31053081
8,70	10	162	120	110	40	SCD611-0870-2-4-140HA12-HP358	31053082
9,00	10	162	120	110	40	SCD611-0900-2-4-140HA12-HP358	31053085
9,50	10	162	120	110	40	SCD611-0950-2-4-140HA12-HP358	31053090
9,60	10	162	120	110	40	SCD611-0960-2-4-140HA12-HP358	31053091
9,80	10	162	120	110	40	SCD611-0980-2-4-140HA12-HP358	31053093
9,90	10	162	120	110	40	SCD611-0990-2-4-140HA12-HP358	31053094
10,00	10	162	120	110	40	SCD611-1000-2-4-140HA12-HP358	31053095
10,20	12	204	156	142	45	SCD611-1020-2-4-140HA12-HP358	31053097
10,50	12	204	156	142	45	SCD611-1050-2-4-140HA12-HP358	31053100
10,60	12	204	156	142	45	SCD611-1060-2-4-140HA12-HP358	31053101
11,00	12	204	156	142	45	SCD611-1100-2-4-140HA12-HP358	31053105
11,20	12	204	156	142	45	SCD611-1120-2-4-140HA12-HP358	31053107
11,70	12	204	156	142	45	SCD611-1170-2-4-140HA12-HP358	31053112
11,80	12	204	156	142	45	SCD611-1180-2-4-140HA12-HP358	31053113
12,00	12	204	156	142	45	SCD611-1200-2-4-140HA12-HP358	31053115
12,50	14	230	182	166	45	SCD611-1250-2-4-140HA12-HP358	31053116
13,00	14	230	182	166	45	SCD611-1300-2-4-140HA12-HP358	31053118
13,50	14	230	182	166	45	SCD611-1350-2-4-140HA12-HP358	31053119
14,00	14	230	182	166	45	SCD611-1400-2-4-140HA12-HP358	31053121
14,50	16	260	208	192	48	SCD611-1450-2-4-140HA12-HP358	31053122
15,00	16	260	208	192	48	SCD611-1500-2-4-140HA12-HP358	31053124
16,00	16	260	208	192	48	SCD611-1600-2-4-140HA12-HP358	31053127
16,50	18	285	234	216	48	SCD611-1650-2-4-140HA12-HP358	31053128
17,50	18	285	234	216	48	SCD611-1750-2-4-140HA12-HP358	31053131
19,50	20	310	258	240	50	SCD611-1950-2-4-140HA12-HP358	31053137

Continúa en la página siguiente.

MEGA-Quadro-Drill-Plus | Broca helicoidal de metal duro SCD611 (12xD), suministro de refrigerante interior

Características configurables

**Diámetro:**

Diámetro seleccionable libremente en incrementos de 0,01 mm

**Forma del mango:**

Forma del mango: HB | HE

Especificación

SCD611-[diámetro]-2-4-140[forma del mango]12-HP358

Dimensiones de la serie configurable

d ₁ min.	d ₁ max.	d ₂ h6	l ₁	l ₂	l ₃	l ₄
3,00	3,70	6	92	54	48	36
3,71	4,70	6	102	64	58	36
4,71	6,00	6	116	78	70	36
6,01	8,00	8	146	108	94	36
8,01	10,00	10	162	120	110	40
10,01	12,00	12	204	156	142	45
12,01	14,00	14	230	182	166	45
14,01	16,00	16	260	208	192	48
16,01	18,00	18	285	234	216	48
18,01	20,00	20	310	258	240	50

Ejemplo:

SCD611-0431-2-4-140HE12-HP358

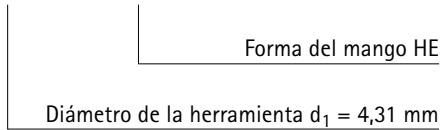

Medidas en mm.

Para la recomendación de valores de corte, véase al final del capítulo.

Ejecuciones especiales y otros recubrimientos a petición.

MICRO-Drill-Steel

Broca helicoidal de metal duro
SCD371 (5xD), suministro de refrigerante interior

Ejecución:

Diámetro de broca: 0,80 – 2,99 mm
Tolerancia del agujero: IT9 (alcanzable)
Material de corte: HP246
Número de insertos: 2
Número de biseles guía: 4
Ángulo de la punta: 142°
Ángulo de hélice: 30°

Aplicación:

Broca piloto especialmente adaptada a MEGA-Deep-Drill.
Se puede utilizar como máximo un diámetro < 3,00 mm.

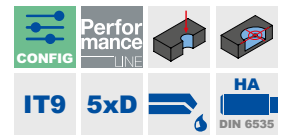
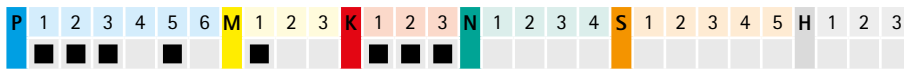
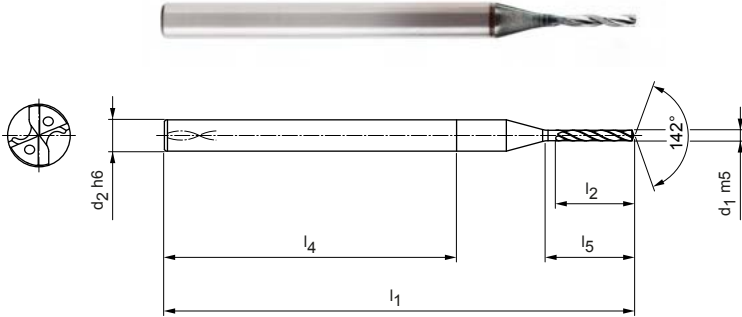

Serie preferente disponible en stock en forma de mango HA

Dimensiones						Forma del mango HA	
d ₁ m5	d ₂ h6	l ₁	l ₂	l ₃	l ₄	Especificación	Referencia
0,80	3	45	6	4	28	SCD371-0080-2-4-142HA05-HP246	31238823
1,00	3	45	7,5	5	28	SCD371-0100-2-4-142HA05-HP246	31238825
1,20	3	45	9	6	28	SCD371-0120-2-4-142HA05-HP246	31238827
1,50	3	45	11,3	7,5	28	SCD371-0150-2-4-142HA05-HP246	31238890
1,60	3	50	12	8	28	SCD371-0160-2-4-142HA05-HP246	31238891
2,00	3	50	15	10	28	SCD371-0200-2-4-142HA05-HP246	31238895
2,40	3	52	18	12	28	SCD371-0240-2-4-142HA05-HP246	31238899
2,50	3	52	18,8	12,5	28	SCD371-0250-2-4-142HA05-HP246	31238900
2,60	3	55	19,5	13	28	SCD371-0260-2-4-142HA05-HP246	31238901
2,80	3	55	21	14	28	SCD371-0280-2-4-142HA05-HP246	31238903

Características configurables



Diámetro:

Diámetro seleccionable libremente en incrementos de 0,01 mm



Especificación

SCD371-[diámetro]-2-4-142HA05-HP246

Dimensiones de la serie configurable

d ₁ min.	d ₁ max.	d ₂ h6	l ₁	l ₂	l ₃	l ₄
0,80	0,99	3	45	6,0	4,0	28
1,00	1,29	3	45	7,5	5,0	28
1,30	1,59	3	45	9,8	6,5	28
1,60	1,89	3	50	12,0	8,0	28
1,90	2,19	3	50	14,3	9,5	28
2,20	2,59	3	52	16,5	11,0	28
2,60	2,99	3	55	19,5	13,0	28

Ejemplo:

SCD371-0221-2-4-142HA05-HP246

Diámetro de la herramienta d₁ = 2,21 mm

Medidas en mm.

Para la recomendación de valores de corte, véase al final del capítulo.
Ejecuciones especiales y otros recubrimientos a petición.

MICRO-Drill-Steel

Broca helicoidal de metal duro
SCD371 (8xD), suministro de refrigerante interior

Ejecución:

Diámetro de broca: 1,00 – 2,99 mm
Tolerancia del agujero: IT9 (alcanzable)
Material de corte: HP246
Número de insertos: 2
Número de bisel guía: 4
Ángulo de la punta: 142°
Ángulo de hélice: 30°

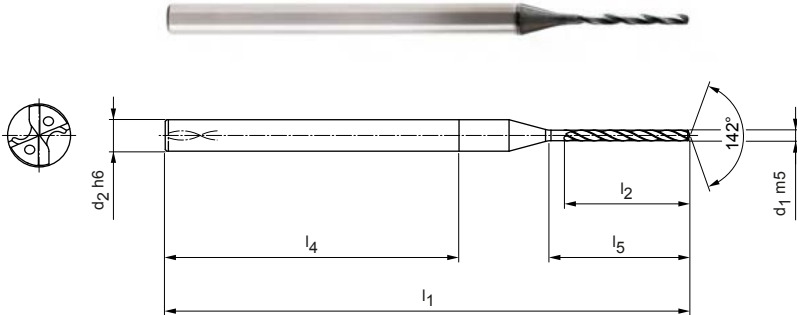

Serie preferente disponible en stock en forma de mango HA

Dimensiones						Forma del mango HA	
d ₁ m5	d ₂ h6	l ₁	l ₂	l ₃	l ₄	Especificación	Referencia
1,00	3	50	12	8	28	SCD371-0100-2-4-142HA08-HP246	31238905
1,20	3	50	14,4	9,6	28	SCD371-0120-2-4-142HA08-HP246	31238907
1,50	3	52	18	12	28	SCD371-0150-2-4-142HA08-HP246	31238910
1,60	3	55	19,2	12,8	28	SCD371-0160-2-4-142HA08-HP246	31238911
2,00	3	60	24	16	28	SCD371-0200-2-4-142HA08-HP246	31238915
2,50	3	62	30	20	28	SCD371-0250-2-4-142HA08-HP246	31238920

Características configurables



Diámetro:

Diámetro seleccionable libremente en incrementos de 0,01 mm



Especificación

SCD371-[diámetro]-2-4-142HA08-HP246

Dimensiones de la serie configurable

d ₁ min.	d ₁ max.	d ₂ h6	l ₁	l ₂	l ₃	l ₄
1,00	1,29	3	50	12,0	8,0	28
1,30	1,59	3	52	15,6	10,4	28
1,60	1,89	3	55	19,2	12,8	28
1,90	2,19	3	60	22,8	15,2	28
2,20	2,59	3	62	26,4	17,6	28
2,60	2,99	3	66	31,2	20,8	28

Ejemplo:

SCD371-0221-2-4-142HA08-HP246

Diámetro de la herramienta d₁ = 2,21 mm

Medidas en mm.

Para la recomendación de valores de corte, véase al final del capítulo.

Ejecuciones especiales y otros recubrimientos a petición.

MICRO-Drill-Steel

Broca helicoidal de metal duro
SCD371 (12xD), suministro de refrigerante interior

Ejecución:
Diámetro de broca: 1,00 – 2,99 mm
Tolerancia del agujero: IT9 (alcanzable)
Material de corte: HP246
Número de insertos: 2
Número de bisel guía: 4
Ángulo de la punta: 142°
Ángulo de hélice: 30°

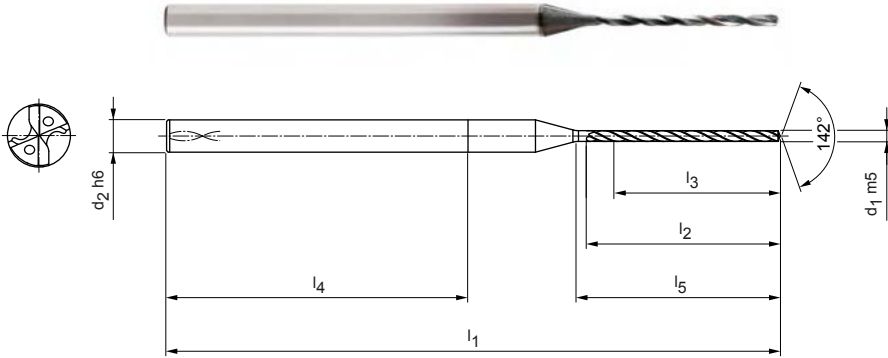

Serie preferente disponible en stock en forma de mango HA

Dimensiones						Forma del mango HA	
d ₁ m5	d ₂ h6	l ₁	l ₂	l ₃	l ₄	Especificación	Referencia
1,00	3	57	18	12	28	SCD371-0100-2-4-142HA12-HP246	31238925
1,20	3	57	21,6	14,4	28	SCD371-0120-2-4-142HA12-HP246	31238927
1,30	3	62	23,4	15,6	28	SCD371-0130-2-4-142HA12-HP246	31238928
1,50	3	62	27	18	28	SCD371-0150-2-4-142HA12-HP246	31238930
2,00	3	72	36	24	28	SCD371-0200-2-4-142HA12-HP246	31238935
2,50	3	79	45	30	28	SCD371-0250-2-4-142HA12-HP246	31238940

Características configurables



Diámetro:
Diámetro seleccionable libremente en incrementos de 0,01 mm



Especificación

SCD371-[diámetro]-2-4-142HA12-HP246

Dimensiones de la serie configurable

d ₁ min.	d ₁ max.	d ₂ h6	l ₁	l ₂	l ₃	l ₄
1,00	1,29	3	57	18,0	12,0	28
1,30	1,59	3	62	23,4	15,6	28
1,60	1,89	3	66	28,8	19,2	28
1,90	2,19	3	72	34,2	22,8	28
2,20	2,59	3	79	39,6	26,4	28
2,60	2,99	3	85	46,8	31,2	28

Ejemplo:

SCD371-0221-2-4-142HA12-HP246

Diámetro de la herramienta d₁ = 2,21 mm

Medidas en mm.

Para la recomendación de valores de corte, véase al final del capítulo.
Ejecuciones especiales y otros recubrimientos a petición.

MEGA-Drill-Hardened

Broca helicoidal de metal duro
SCD140 (3xD)

Ejecución:

Diámetro de broca: 2,55 – 20,00 mm
Tolerancia del agujero: IT 9 (alcanzable)
Material de corte: HP809
Número de insertos: 2
Número de bisel guía: 2
Ángulo de la punta: 140°
Ángulo de hélice: 15°

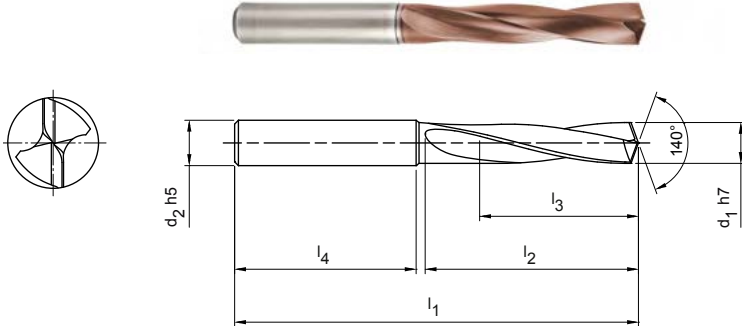

Serie preferente disponible en stock en forma de mango HA

Dimensiones						Forma del mango HA	
d ₁ h7	d ₂ h5	l ₁	l ₂	l ₃	l ₄	Especificación	Referencia
2,55	6	62	20	14	36	SCD140-0255-2-2-140HA03-HP809	31198190
2,60	6	62	20	14	36	SCD140-0260-2-2-140HA03-HP809	31198191
2,70	6	62	20	14	36	SCD140-0270-2-2-140HA03-HP809	31198192
2,80	6	62	20	14	36	SCD140-0280-2-2-140HA03-HP809	31198194
2,90	6	62	20	14	36	SCD140-0290-2-2-140HA03-HP809	31198196
3,00	6	62	20	14	36	SCD140-0300-2-2-140HA03-HP809	31151191
3,10	6	62	20	14	36	SCD140-0310-2-2-140HA03-HP809	31151192
3,20	6	62	20	14	36	SCD140-0320-2-2-140HA03-HP809	31151193
3,30	6	62	20	14	36	SCD140-0330-2-2-140HA03-HP809	31151194
3,40	6	62	20	14	36	SCD140-0340-2-2-140HA03-HP809	31151195
3,50	6	62	20	14	36	SCD140-0350-2-2-140HA03-HP809	31151196
3,60	6	62	20	14	36	SCD140-0360-2-2-140HA03-HP809	31151197
3,70	6	62	20	14	36	SCD140-0370-2-2-140HA03-HP809	31151198
3,80	6	66	24	17	36	SCD140-0380-2-2-140HA03-HP809	31151199
3,90	6	66	24	17	36	SCD140-0390-2-2-140HA03-HP809	31151330
4,00	6	66	24	17	36	SCD140-0400-2-2-140HA03-HP809	31151331
4,10	6	66	24	17	36	SCD140-0410-2-2-140HA03-HP809	31151332
4,20	6	66	24	17	36	SCD140-0420-2-2-140HA03-HP809	31151333
4,30	6	66	24	17	36	SCD140-0430-2-2-140HA03-HP809	31151334
4,40	6	66	24	17	36	SCD140-0440-2-2-140HA03-HP809	31151335
4,50	6	66	24	17	36	SCD140-0450-2-2-140HA03-HP809	31151336
4,60	6	66	24	17	36	SCD140-0460-2-2-140HA03-HP809	31151337
4,70	6	66	24	17	36	SCD140-0470-2-2-140HA03-HP809	31151339
4,80	6	66	28	20	36	SCD140-0480-2-2-140HA03-HP809	31151340
4,90	6	66	28	20	36	SCD140-0490-2-2-140HA03-HP809	31151341
5,00	6	66	28	20	36	SCD140-0500-2-2-140HA03-HP809	31151342
5,10	6	66	28	20	36	SCD140-0510-2-2-140HA03-HP809	31151343
5,20	6	66	28	20	36	SCD140-0520-2-2-140HA03-HP809	31151344
5,30	6	66	28	20	36	SCD140-0530-2-2-140HA03-HP809	31151345
5,40	6	66	28	20	36	SCD140-0540-2-2-140HA03-HP809	31151346
5,50	6	66	28	20	36	SCD140-0550-2-2-140HA03-HP809	31151347
5,55	6	66	28	20	36	SCD140-0555-2-2-140HA03-HP809	31151348
5,60	6	66	28	20	36	SCD140-0560-2-2-140HA03-HP809	31151349
5,70	6	66	28	20	36	SCD140-0570-2-2-140HA03-HP809	31151350
5,80	6	66	28	20	36	SCD140-0580-2-2-140HA03-HP809	31151351

MEGA-Drill-Hardened | Broca helicoidal de metal duro SCD140 (3xD)

Dimensiones						Forma del mango HA	
d ₁ h7	d ₂ h6	l ₁	l ₂	l ₃	l ₄	Especificación	Referencia
5,90	6	66	28	20	36	SCD140-0590-2-2-140HA03-HP809	31151352
6,00	6	66	28	20	36	SCD140-0600-2-2-140HA03-HP809	31151353
6,10	8	79	34	24	36	SCD140-0610-2-2-140HA03-HP809	31151354
6,20	8	79	34	24	36	SCD140-0620-2-2-140HA03-HP809	31151355
6,30	8	79	34	24	36	SCD140-0630-2-2-140HA03-HP809	31151356
6,40	8	79	34	24	36	SCD140-0640-2-2-140HA03-HP809	31151357
6,50	8	79	34	24	36	SCD140-0650-2-2-140HA03-HP809	31151358
6,60	8	79	34	24	36	SCD140-0660-2-2-140HA03-HP809	31151359
6,70	8	79	34	24	36	SCD140-0670-2-2-140HA03-HP809	31151360
6,80	8	79	34	24	36	SCD140-0680-2-2-140HA03-HP809	31151361
6,90	8	79	34	24	36	SCD140-0690-2-2-140HA03-HP809	31151362
7,00	8	79	34	24	36	SCD140-0700-2-2-140HA03-HP809	31151363
7,10	8	79	41	29	36	SCD140-0710-2-2-140HA03-HP809	31151364
7,30	8	79	41	29	36	SCD140-0730-2-2-140HA03-HP809	31151366
7,40	8	79	41	29	36	SCD140-0740-2-2-140HA03-HP809	31151367
7,50	8	79	41	29	36	SCD140-0750-2-2-140HA03-HP809	31151368
7,80	8	79	41	29	36	SCD140-0780-2-2-140HA03-HP809	31151371
7,90	8	79	41	29	36	SCD140-0790-2-2-140HA03-HP809	31151372
8,00	8	79	41	29	36	SCD140-0800-2-2-140HA03-HP809	31151373
8,10	10	89	47	35	40	SCD140-0810-2-2-140HA03-HP809	31151374
8,20	10	89	47	35	40	SCD140-0820-2-2-140HA03-HP809	31151375
8,50	10	89	47	35	40	SCD140-0850-2-2-140HA03-HP809	31151378
8,60	10	89	47	35	40	SCD140-0860-2-2-140HA03-HP809	31151379
8,80	10	89	47	35	40	SCD140-0880-2-2-140HA03-HP809	31151381
9,00	10	89	47	35	40	SCD140-0900-2-2-140HA03-HP809	31151383
9,30	10	89	47	35	40	SCD140-0930-2-2-140HA03-HP809	31151386
9,50	10	89	47	35	40	SCD140-0950-2-2-140HA03-HP809	31151388
9,60	10	89	47	35	40	SCD140-0960-2-2-140HA03-HP809	31151389
9,70	10	89	47	35	40	SCD140-0970-2-2-140HA03-HP809	31151390
9,80	10	89	47	35	40	SCD140-0980-2-2-140HA03-HP809	31151391
10,00	10	89	47	35	40	SCD140-1000-2-2-140HA03-HP809	31151393
10,10	12	102	55	40	45	SCD140-1010-2-2-140HA03-HP809	31151394
10,20	12	102	55	40	45	SCD140-1020-2-2-140HA03-HP809	31151395
10,30	12	102	55	40	45	SCD140-1030-2-2-140HA03-HP809	31151396
10,40	12	102	55	40	45	SCD140-1040-2-2-140HA03-HP809	31151397
10,50	12	102	55	40	45	SCD140-1050-2-2-140HA03-HP809	31151398
11,00	12	102	55	40	45	SCD140-1100-2-2-140HA03-HP809	31151403
11,50	12	102	55	40	45	SCD140-1150-2-2-140HA03-HP809	31151408
11,80	12	102	55	40	45	SCD140-1180-2-2-140HA03-HP809	31151411
11,90	12	102	55	40	45	SCD140-1190-2-2-140HA03-HP809	31151412
12,00	12	102	55	40	45	SCD140-1200-2-2-140HA03-HP809	31151413
12,50	14	107	60	43	45	SCD140-1250-2-2-140HA03-HP809	31151415
12,80	14	107	60	43	45	SCD140-1280-2-2-140HA03-HP809	31151416
13,00	14	107	60	43	45	SCD140-1300-2-2-140HA03-HP809	31151417
13,50	14	107	60	43	45	SCD140-1350-2-2-140HA03-HP809	31151418
14,00	14	107	60	43	45	SCD140-1400-2-2-140HA03-HP809	31151420
14,20	16	115	65	45	48	SCD140-1420-2-2-140HA03-HP809	31151421
14,50	16	115	65	45	48	SCD140-1450-2-2-140HA03-HP809	31151422
14,80	16	115	65	45	48	SCD140-1480-2-2-140HA03-HP809	31151423
15,00	16	115	65	45	48	SCD140-1500-2-2-140HA03-HP809	31151424
15,50	16	115	65	45	48	SCD140-1550-2-2-140HA03-HP809	31151426
16,00	16	115	65	45	48	SCD140-1600-2-2-140HA03-HP809	31151428
17,50	18	123	73	51	48	SCD140-1750-2-2-140HA03-HP809	31151432

Continúa en la página siguiente.

MEGA-Drill-Hardened | Broca helicoidal de metal duro SCD140 (3xD)

Características configurables

**Diámetro:**

Diámetro seleccionable libremente en incrementos de 0,01 mm

**Forma del mango:**

Forma del mango: HB | HE

Especificación

SCD140-[diámetro]-2-2-140[forma del mango]03-HP809

Dimensiones de la serie configurable

d ₁ min.	d ₁ max.	d ₂ h6	l ₁	l ₂	l ₃	l ₄
2,55	3,79	6	62	20	14	36
3,80	4,79	6	66	24	17	36
4,80	6,00	6	66	28	20	36
6,01	7,00	8	79	34	24	36
7,01	8,00	8	79	41	29	36
8,01	10,00	10	89	47	35	40
10,01	12,00	12	102	55	40	45
12,01	14,00	14	107	60	43	45
14,01	16,00	16	115	65	45	48
16,01	18,00	18	123	73	51	48
18,01	20,00	20	131	79	55	50

Ejemplo:

SCD140-0431-2-2-140HE03-HP809

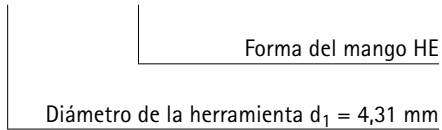

Medidas en mm.

Para la recomendación de valores de corte, véase al final del capítulo.

Ejecuciones especiales y otros recubrimientos a petición.

Tritan-Drill-Steel

Broca helicoidal de metal duro
SCD661 (3xD), suministro de refrigerante interior

Ejecución:
 Diámetro de broca: 4,00 – 20,00 mm
 Tolerancia del agujero: ≥ IT 9
 Material de corte: HP358
 Número de insertos: 3
 Número de biseles guía: 3
 Ángulo de la punta: 145°
 Ángulo de hélice: 30°

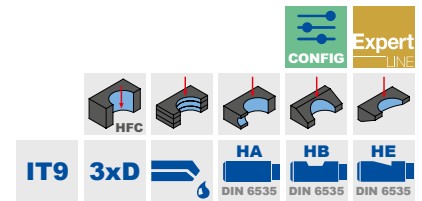
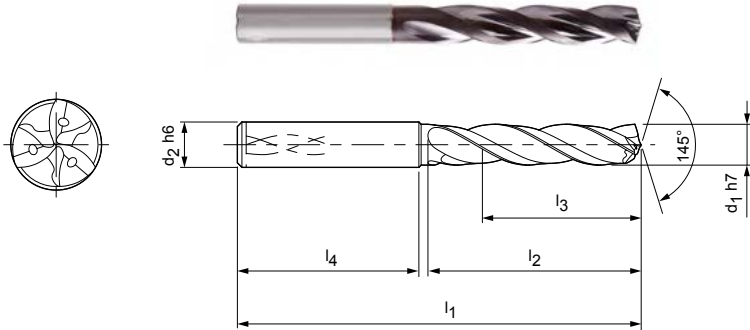

Serie preferente disponible en stock en forma de mango HA

Dimensiones						Forma del mango HA	
d ₁ h7	d ₂ h6	l ₁	l ₂	l ₃	l ₄	Especificación	Referencia
4,00	6	66	24	17	36	SCD661-0400-3-3-145HA03-HP358	30902036
4,10	6	66	24	17	36	SCD661-0410-3-3-145HA03-HP358	30902037
4,20	6	66	24	17	36	SCD661-0420-3-3-145HA03-HP358	30902038
4,30	6	66	24	17	36	SCD661-0430-3-3-145HA03-HP358	30902039
4,40	6	66	24	17	36	SCD661-0440-3-3-145HA03-HP358	30902040
4,50	6	66	24	17	36	SCD661-0450-3-3-145HA03-HP358	30902041
4,60	6	66	24	17	36	SCD661-0460-3-3-145HA03-HP358	30902042
4,65	6	66	24	17	36	SCD661-0465-3-3-145HA03-HP358	30902043
4,70	6	66	24	17	36	SCD661-0470-3-3-145HA03-HP358	30902044
4,80	6	66	28	20	36	SCD661-0480-3-3-145HA03-HP358	30902045
4,90	6	66	28	20	36	SCD661-0490-3-3-145HA03-HP358	30902046
5,00	6	66	28	20	36	SCD661-0500-3-3-145HA03-HP358	30902047
5,10	6	66	28	20	36	SCD661-0510-3-3-145HA03-HP358	30902048
5,20	6	66	28	20	36	SCD661-0520-3-3-145HA03-HP358	30902049
5,30	6	66	28	20	36	SCD661-0530-3-3-145HA03-HP358	30902050
5,40	6	66	28	20	36	SCD661-0540-3-3-145HA03-HP358	30902051
5,50	6	66	28	20	36	SCD661-0550-3-3-145HA03-HP358	30902052
5,55	6	66	28	20	36	SCD661-0555-3-3-145HA03-HP358	30902053
5,60	6	66	28	20	36	SCD661-0560-3-3-145HA03-HP358	30902054
5,70	6	66	28	20	36	SCD661-0570-3-3-145HA03-HP358	30902055
5,80	6	66	28	20	36	SCD661-0580-3-3-145HA03-HP358	30902056
5,90	6	66	28	20	36	SCD661-0590-3-3-145HA03-HP358	30902057
6,00	6	66	28	20	36	SCD661-0600-3-3-145HA03-HP358	30902058
6,10	8	79	34	24	36	SCD661-0610-3-3-145HA03-HP358	30902059
6,20	8	79	34	24	36	SCD661-0620-3-3-145HA03-HP358	30902060
6,30	8	79	34	24	36	SCD661-0630-3-3-145HA03-HP358	30902061
6,35	8	79	34	24	36	SCD661-0635-3-3-145HA03-HP358	31307522
6,40	8	79	34	24	36	SCD661-0640-3-3-145HA03-HP358	30902062
6,50	8	79	34	24	36	SCD661-0650-3-3-145HA03-HP358	30902063
6,60	8	79	34	24	36	SCD661-0660-3-3-145HA03-HP358	30902064
6,70	8	79	34	24	36	SCD661-0670-3-3-145HA03-HP358	30902065
6,80	8	79	34	24	36	SCD661-0680-3-3-145HA03-HP358	30902066
6,90	8	79	34	24	36	SCD661-0690-3-3-145HA03-HP358	30902067
7,00	8	79	34	24	36	SCD661-0700-3-3-145HA03-HP358	30902068
7,10	8	79	41	29	36	SCD661-0710-3-3-145HA03-HP358	30902069

Tritan-Drill-Steel | Broca helicoidal de metal duro SCD661 (3xD), suministro de refrigerante interior

Dimensiones						Forma del mango HA	
d ₁ h7	d ₂ h6	l ₁	l ₂	l ₃	l ₄	Especificación	Referencia
7,20	8	79	41	29	36	SCD661-0720-3-3-145HA03-HP358	30902070
7,30	8	79	41	29	36	SCD661-0730-3-3-145HA03-HP358	30902071
7,40	8	79	41	29	36	SCD661-0740-3-3-145HA03-HP358	30902072
7,45	8	79	41	29	36	SCD661-0745-3-3-145HA03-HP358	30902073
7,50	8	79	41	29	36	SCD661-0750-3-3-145HA03-HP358	30902074
7,60	8	79	41	29	36	SCD661-0760-3-3-145HA03-HP358	30902075
7,70	8	79	41	29	36	SCD661-0770-3-3-145HA03-HP358	30902076
7,80	8	79	41	29	36	SCD661-0780-3-3-145HA03-HP358	30902077
7,90	8	79	41	29	36	SCD661-0790-3-3-145HA03-HP358	30902078
8,00	8	79	41	29	36	SCD661-0800-3-3-145HA03-HP358	30902079
8,10	10	89	47	35	40	SCD661-0810-3-3-145HA03-HP358	30902080
8,20	10	89	47	35	40	SCD661-0820-3-3-145HA03-HP358	30902081
8,30	10	89	47	35	40	SCD661-0830-3-3-145HA03-HP358	30902082
8,40	10	89	47	35	40	SCD661-0840-3-3-145HA03-HP358	30902083
8,50	10	89	47	35	40	SCD661-0850-3-3-145HA03-HP358	30902084
8,60	10	89	47	35	40	SCD661-0860-3-3-145HA03-HP358	30902085
8,70	10	89	47	35	40	SCD661-0870-3-3-145HA03-HP358	30902086
8,80	10	89	47	35	40	SCD661-0880-3-3-145HA03-HP358	30902087
9,00	10	89	47	35	40	SCD661-0900-3-3-145HA03-HP358	30902089
9,10	10	89	47	35	40	SCD661-0910-3-3-145HA03-HP358	30902090
9,20	10	89	47	35	40	SCD661-0920-3-3-145HA03-HP358	30902091
9,30	10	89	47	35	40	SCD661-0930-3-3-145HA03-HP358	30902092
9,35	10	89	47	35	40	SCD661-0935-3-3-145HA03-HP358	31307523
9,40	10	89	47	35	40	SCD661-0940-3-3-145HA03-HP358	30902093
9,50	10	89	47	35	40	SCD661-0950-3-3-145HA03-HP358	30902094
9,60	10	89	47	35	40	SCD661-0960-3-3-145HA03-HP358	30902095
9,70	10	89	47	35	40	SCD661-0970-3-3-145HA03-HP358	30902096
9,80	10	89	47	35	40	SCD661-0980-3-3-145HA03-HP358	30902097
9,90	10	89	47	35	40	SCD661-0990-3-3-145HA03-HP358	30902098
10,00	10	89	47	35	40	SCD661-1000-3-3-145HA03-HP358	30902099
10,10	12	102	55	40	45	SCD661-1010-3-3-145HA03-HP358	30902100
10,20	12	102	55	40	45	SCD661-1020-3-3-145HA03-HP358	30902101
10,30	12	102	55	40	45	SCD661-1030-3-3-145HA03-HP358	30902102
10,40	12	102	55	40	45	SCD661-1040-3-3-145HA03-HP358	30902103
10,50	12	102	55	40	45	SCD661-1050-3-3-145HA03-HP358	30902104
10,80	12	102	55	40	45	SCD661-1080-3-3-145HA03-HP358	30902107
10,90	12	102	55	40	45	SCD661-1090-3-3-145HA03-HP358	30902108
11,00	12	102	55	40	45	SCD661-1100-3-3-145HA03-HP358	30902109
11,10	12	102	55	40	45	SCD661-1110-3-3-145HA03-HP358	30902110
11,20	12	102	55	40	45	SCD661-1120-3-3-145HA03-HP358	30902111
11,30	12	102	55	40	45	SCD661-1130-3-3-145HA03-HP358	30902112
11,40	12	102	55	40	45	SCD661-1140-3-3-145HA03-HP358	30902113
11,50	12	102	55	40	45	SCD661-1150-3-3-145HA03-HP358	30902114
11,60	12	102	55	40	45	SCD661-1160-3-3-145HA03-HP358	30902115
11,70	12	102	55	40	45	SCD661-1170-3-3-145HA03-HP358	30902116
11,80	12	102	55	40	45	SCD661-1180-3-3-145HA03-HP358	30902117
11,90	12	102	55	40	45	SCD661-1190-3-3-145HA03-HP358	30902118
12,00	12	102	55	40	45	SCD661-1200-3-3-145HA03-HP358	30902119
12,20	14	107	60	43	45	SCD661-1220-3-3-145HA03-HP358	30902120
12,23	14	107	60	43	45	SCD661-1223-3-3-145HA03-HP358	31271441
12,50	14	107	60	43	45	SCD661-1250-3-3-145HA03-HP358	30902121
12,70	14	107	60	43	45	SCD661-1270-3-3-145HA03-HP358	31307524
13,00	14	107	60	43	45	SCD661-1300-3-3-145HA03-HP358	30902123
13,50	14	107	60	43	45	SCD661-1350-3-3-145HA03-HP358	30902125
13,80	14	107	60	43	45	SCD661-1380-3-3-145HA03-HP358	30902126
14,00	14	107	60	43	45	SCD661-1400-3-3-145HA03-HP358	30902127
14,20	16	115	65	45	48	SCD661-1420-3-3-145HA03-HP358	30902128

Tritan-Drill-Steel | Broca helicoidal de metal duro SCD661 (3xD), suministro de refrigerante interior

Dimensiones						Forma del mango HA	
d ₁ h7	d ₂ h6	l ₁	l ₂	l ₃	l ₄	Especificación	Referencia
14,50	16	115	65	45	48	SCD661-1450-3-3-145HA03-HP358	30902129
14,80	16	115	65	45	48	SCD661-1480-3-3-145HA03-HP358	30902130
15,00	16	115	65	45	48	SCD661-1500-3-3-145HA03-HP358	30902131
15,20	16	115	65	45	48	SCD661-1520-3-3-145HA03-HP358	30902132
15,50	16	115	65	45	48	SCD661-1550-3-3-145HA03-HP358	30902133
15,80	16	115	65	45	48	SCD661-1580-3-3-145HA03-HP358	30902134
16,00	16	115	65	45	48	SCD661-1600-3-3-145HA03-HP358	30902135
16,20	18	123	73	51	48	SCD661-1620-3-3-145HA03-HP358	30902136
16,50	18	123	73	51	48	SCD661-1650-3-3-145HA03-HP358	30902137
17,00	18	123	73	51	48	SCD661-1700-3-3-145HA03-HP358	30902139
17,35	18	123	73	51	48	SCD661-1735-3-3-145HA03-HP358	31307525
17,50	18	123	73	51	48	SCD661-1750-3-3-145HA03-HP358	30902141
17,80	18	123	73	51	48	SCD661-1780-3-3-145HA03-HP358	30902142
18,00	18	123	73	51	48	SCD661-1800-3-3-145HA03-HP358	30902143
18,50	20	131	79	55	50	SCD661-1850-3-3-145HA03-HP358	30902145
18,80	20	131	79	55	50	SCD661-1880-3-3-145HA03-HP358	30902146
19,00	20	131	79	55	50	SCD661-1900-3-3-145HA03-HP358	30902147
19,50	20	131	79	55	50	SCD661-1950-3-3-145HA03-HP358	30902149
20,00	20	131	79	55	50	SCD661-2000-3-3-145HA03-HP358	30902151

Características configurables

**Diámetro:**

Diámetro seleccionable libremente en incrementos de 0,01 mm

**Forma del mango:**

Forma del mango: HB | HE

Especificación

SCD661-[diámetro]-3-3-140[forma del mango]03-HP358

Dimensiones de la serie configurable

d ₁ min.	d ₁ max.	d ₂ h6	l ₁	l ₂	l ₃	l ₄
4,00	4,70	6	66	24	17	36
4,71	6,00	6	66	28	20	36
6,01	7,00	8	79	34	24	36
7,01	8,00	8	79	41	29	36
8,01	10,00	10	89	47	35	40
10,01	12,00	12	102	55	40	45
12,01	14,00	14	107	60	43	45
14,01	16,00	16	115	65	45	48
16,01	18,00	18	123	73	51	48
18,01	20,00	20	131	79	55	50

Ejemplo:

SCD661-0431-3-3-140HE03-HP358

Forma del mango HE

Diámetro de la herramienta d₁ = 4,31 mm

Medidas en mm.

Para la recomendación de valores de corte, véase al final del capítulo.

Ejecuciones especiales y otros recubrimientos a petición.

Tritan-Drill-Steel

Broca helicoidal de metal duro
SCD661 (5xD), suministro de refrigerante interior

Ejecución:
 Diámetro de broca: 4,00 – 20,00 mm
 Tolerancia del agujero: $\geq IT 9$
 Material de corte: HP358
 Número de insertos: 3
 Número de biseles guía: 3
 Ángulo de la punta: 145°
 Ángulo de hélice: 30°

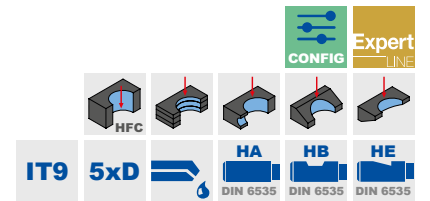
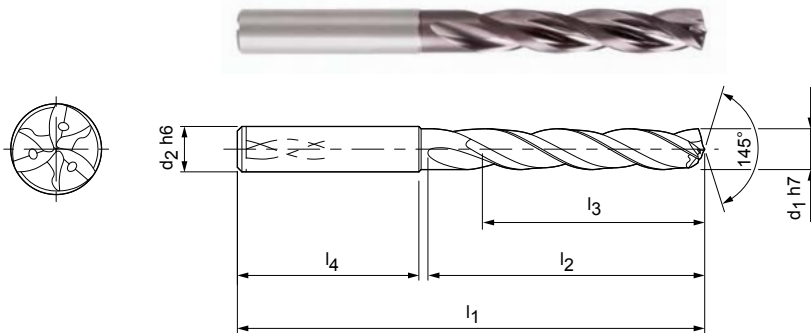

Serie preferente disponible en stock en forma de mango HA

Dimensiones						Forma del mango HA	
d ₁ h7	d ₂ h6	l ₁	l ₂	l ₃	l ₄	Especificación	Referencia
4,00	6	74	36	29	36	SCD661-0400-3-3-145HA05-HP358	30902152
4,10	6	74	36	29	36	SCD661-0410-3-3-145HA05-HP358	30902153
4,20	6	74	36	29	36	SCD661-0420-3-3-145HA05-HP358	30902154
4,30	6	74	36	29	36	SCD661-0430-3-3-145HA05-HP358	30902155
4,40	6	74	36	29	36	SCD661-0440-3-3-145HA05-HP358	30902156
4,50	6	74	36	29	36	SCD661-0450-3-3-145HA05-HP358	30902157
4,60	6	74	36	29	36	SCD661-0460-3-3-145HA05-HP358	30902158
4,65	6	74	36	29	36	SCD661-0465-3-3-145HA05-HP358	30902159
4,70	6	74	36	29	36	SCD661-0470-3-3-145HA05-HP358	30902160
4,80	6	82	44	35	36	SCD661-0480-3-3-145HA05-HP358	30902161
4,90	6	82	44	35	36	SCD661-0490-3-3-145HA05-HP358	30902162
5,00	6	82	44	35	36	SCD661-0500-3-3-145HA05-HP358	30902163
5,10	6	82	44	35	36	SCD661-0510-3-3-145HA05-HP358	30902164
5,20	6	82	44	35	36	SCD661-0520-3-3-145HA05-HP358	30902165
5,30	6	82	44	35	36	SCD661-0530-3-3-145HA05-HP358	30902166
5,40	6	82	44	35	36	SCD661-0540-3-3-145HA05-HP358	30902167
5,50	6	82	44	35	36	SCD661-0550-3-3-145HA05-HP358	30902168
5,55	6	82	44	35	36	SCD661-0555-3-3-145HA05-HP358	30902169
5,60	6	82	44	35	36	SCD661-0560-3-3-145HA05-HP358	30902170
5,70	6	82	44	35	36	SCD661-0570-3-3-145HA05-HP358	30902171
5,80	6	82	44	35	36	SCD661-0580-3-3-145HA05-HP358	30902172
5,90	6	82	44	35	36	SCD661-0590-3-3-145HA05-HP358	30902173
6,00	6	82	44	35	36	SCD661-0600-3-3-145HA05-HP358	30902174
6,05	8	91	53	43	36	SCD661-0605-3-3-145HA05-HP358	31307526
6,10	8	91	53	43	36	SCD661-0610-3-3-145HA05-HP358	30902175
6,20	8	91	53	43	36	SCD661-0620-3-3-145HA05-HP358	30902176
6,30	8	91	53	43	36	SCD661-0630-3-3-145HA05-HP358	30902177
6,40	8	91	53	43	36	SCD661-0640-3-3-145HA05-HP358	30902178
6,50	8	91	53	43	36	SCD661-0650-3-3-145HA05-HP358	30902179
6,60	8	91	53	43	36	SCD661-0660-3-3-145HA05-HP358	30902180
6,80	8	91	53	43	36	SCD661-0680-3-3-145HA05-HP358	30902182
6,90	8	91	53	43	36	SCD661-0690-3-3-145HA05-HP358	30902183
7,00	8	91	53	43	36	SCD661-0700-3-3-145HA05-HP358	30902184
7,10	8	91	53	43	36	SCD661-0710-3-3-145HA05-HP358	30902185
7,20	8	91	53	43	36	SCD661-0720-3-3-145HA05-HP358	30902186

Tritan-Drill-Steel | Broca helicoidal de metal duro SCD661 (5xD), suministro de refrigerante interior

Dimensiones						Forma del mango HA	
d ₁ h7	d ₂ h6	l ₁	l ₂	l ₃	l ₄	Especificación	Referencia
7,30	8	91	53	43	36	SCD661-0730-3-3-145HA05-HP358	30902187
7,40	8	91	53	43	36	SCD661-0740-3-3-145HA05-HP358	30902188
7,45	8	91	53	43	36	SCD661-0745-3-3-145HA05-HP358	30902189
7,50	8	91	53	43	36	SCD661-0750-3-3-145HA05-HP358	30902190
7,60	8	91	53	43	36	SCD661-0760-3-3-145HA05-HP358	30902191
7,70	8	91	53	43	36	SCD661-0770-3-3-145HA05-HP358	30902192
7,80	8	91	53	43	36	SCD661-0780-3-3-145HA05-HP358	30902193
7,90	8	91	53	43	36	SCD661-0790-3-3-145HA05-HP358	30902194
8,00	8	91	53	43	36	SCD661-0800-3-3-145HA05-HP358	30902195
8,10	10	103	61	49	40	SCD661-0810-3-3-145HA05-HP358	30902196
8,20	10	103	61	49	40	SCD661-0820-3-3-145HA05-HP358	30902197
8,30	10	103	61	49	40	SCD661-0830-3-3-145HA05-HP358	30902198
8,40	10	103	61	49	40	SCD661-0840-3-3-145HA05-HP358	30902199
8,50	10	103	61	49	40	SCD661-0850-3-3-145HA05-HP358	30902200
8,60	10	103	61	49	40	SCD661-0860-3-3-145HA05-HP358	30902201
8,70	10	103	61	49	40	SCD661-0870-3-3-145HA05-HP358	30902202
8,80	10	103	61	49	40	SCD661-0880-3-3-145HA05-HP358	30902203
8,90	10	103	61	49	40	SCD661-0890-3-3-145HA05-HP358	30902204
9,00	10	103	61	49	40	SCD661-0900-3-3-145HA05-HP358	30902205
9,10	10	103	61	49	40	SCD661-0910-3-3-145HA05-HP358	30902206
9,20	10	103	61	49	40	SCD661-0920-3-3-145HA05-HP358	30902207
9,30	10	103	61	49	40	SCD661-0930-3-3-145HA05-HP358	30902208
9,35	10	103	61	49	40	SCD661-0935-3-3-145HA05-HP358	30902209
9,40	10	103	61	49	40	SCD661-0940-3-3-145HA05-HP358	30902210
9,50	10	103	61	49	40	SCD661-0950-3-3-145HA05-HP358	30902211
9,70	10	103	61	49	40	SCD661-0970-3-3-145HA05-HP358	30902214
9,80	10	103	61	49	40	SCD661-0980-3-3-145HA05-HP358	30902215
9,90	10	103	61	49	40	SCD661-0990-3-3-145HA05-HP358	30902216
10,00	10	103	61	49	40	SCD661-1000-3-3-145HA05-HP358	30902217
10,10	12	118	71	56	45	SCD661-1010-3-3-145HA05-HP358	30902218
10,20	12	118	71	56	45	SCD661-1020-3-3-145HA05-HP358	30902219
10,30	12	118	71	56	45	SCD661-1030-3-3-145HA05-HP358	30902220
10,40	12	118	71	56	45	SCD661-1040-3-3-145HA05-HP358	30902221
10,50	12	118	71	56	45	SCD661-1050-3-3-145HA05-HP358	30902222
10,80	12	118	71	56	45	SCD661-1080-3-3-145HA05-HP358	30902225
11,00	12	118	71	56	45	SCD661-1100-3-3-145HA05-HP358	30902227
11,10	12	118	71	56	45	SCD661-1110-3-3-145HA05-HP358	30902228
11,20	12	118	71	56	45	SCD661-1120-3-3-145HA05-HP358	30902229
11,30	12	118	71	56	45	SCD661-1130-3-3-145HA05-HP358	30902230
11,40	12	118	71	56	45	SCD661-1140-3-3-145HA05-HP358	30902231
11,50	12	118	71	56	45	SCD661-1150-3-3-145HA05-HP358	30902232
11,80	12	118	71	56	45	SCD661-1180-3-3-145HA05-HP358	30902235
11,90	12	118	71	56	45	SCD661-1190-3-3-145HA05-HP358	30902236
12,00	12	118	71	56	45	SCD661-1200-3-3-145HA05-HP358	30902237
12,20	14	124	77	60	45	SCD661-1220-3-3-145HA05-HP358	30902238
12,50	14	124	77	60	45	SCD661-1250-3-3-145HA05-HP358	30902239
12,80	14	124	77	60	45	SCD661-1280-3-3-145HA05-HP358	30902240
13,00	14	124	77	60	45	SCD661-1300-3-3-145HA05-HP358	30902241
13,50	14	124	77	60	45	SCD661-1350-3-3-145HA05-HP358	30902243
13,80	14	124	77	60	45	SCD661-1380-3-3-145HA05-HP358	30902244
14,00	14	124	77	60	45	SCD661-1400-3-3-145HA05-HP358	30902245
14,20	16	133	83	63	48	SCD661-1420-3-3-145HA05-HP358	30902246
14,50	16	133	83	63	48	SCD661-1450-3-3-145HA05-HP358	30902247
14,80	16	133	83	63	48	SCD661-1480-3-3-145HA05-HP358	30902248
15,00	16	133	83	63	48	SCD661-1500-3-3-145HA05-HP358	30902249
15,10	16	133	83	63	48	SCD661-1510-3-3-145HA05-HP358	30902250
15,20	16	133	83	63	48	SCD661-1520-3-3-145HA05-HP358	30902251

Continúa en la página siguiente.

Tritan-Drill-Steel | Broca helicoidal de metal duro SCD661 (5xD), suministro de refrigerante interior

Dimensiones						Forma del mango HA	
d ₁ h7	d ₂ h6	l ₁	l ₂	l ₃	l ₄	Especificación	Referencia
15,25	16	133	83	63	48	SCD661-1525-3-3-145HA05-HP358	30902252
15,50	16	133	83	63	48	SCD661-1550-3-3-145HA05-HP358	30902253
15,80	16	133	83	63	48	SCD661-1580-3-3-145HA05-HP358	30902254
16,00	16	133	83	63	48	SCD661-1600-3-3-145HA05-HP358	30902255
16,20	18	143	93	71	48	SCD661-1620-3-3-145HA05-HP358	30902256
16,50	18	143	93	71	48	SCD661-1650-3-3-145HA05-HP358	30902257
16,80	18	143	93	71	48	SCD661-1680-3-3-145HA05-HP358	30902258
17,00	18	143	93	71	48	SCD661-1700-3-3-145HA05-HP358	30902259
17,50	18	143	93	71	48	SCD661-1750-3-3-145HA05-HP358	30902261
18,00	18	143	93	71	48	SCD661-1800-3-3-145HA05-HP358	30902263
18,50	20	153	101	77	50	SCD661-1850-3-3-145HA05-HP358	30902265
18,80	20	153	101	77	50	SCD661-1880-3-3-145HA05-HP358	30902266
19,00	20	153	101	77	50	SCD661-1900-3-3-145HA05-HP358	30902267
19,50	20	153	101	77	50	SCD661-1950-3-3-145HA05-HP358	30902269
19,80	20	153	101	77	50	SCD661-1980-3-3-145HA05-HP358	30902270
20,00	20	153	101	77	50	SCD661-2000-3-3-145HA05-HP358	30902271

Características configurables

**Diámetro:**

Diámetro seleccionable libremente en incrementos de 0,01 mm

**Forma del mango:**

Forma del mango: HB | HE

Especificación

SCD661-[diámetro]-3-3-145[forma del mango]05-HP358

Dimensiones de la serie configurable

d ₁ min.	d ₁ max.	d ₂ h6	l ₁	l ₂	l ₃	l ₄
4,00	4,70	6	74	36	29	36
4,71	6,00	6	82	44	35	36
6,01	8,00	8	91	53	43	36
8,01	10,00	10	103	61	49	40
10,01	12,00	12	118	71	56	45
12,01	14,00	14	124	77	60	45
14,01	16,00	16	133	83	63	48
16,01	18,00	18	143	93	71	48
18,01	20,00	20	153	101	77	50

Ejemplo:

SCD661-0431-3-3-145HE05-HP358

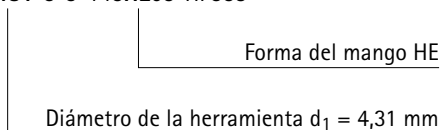

Medidas en mm.

Para la recomendación de valores de corte, véase al final del capítulo.

Ejecuciones especiales y otros recubrimientos a petición.

Tritan-Drill-Steel

Broca helicoidal de metal duro
SCD661 (8xD), suministro de refrigerante interior

Ejecución:
 Diámetro de broca: 4,00 – 20,00 mm
 Tolerancia del agujero: $\geq IT 9$
 Material de corte: HP358
 Número de insertos: 3
 Número de biseles guía: 3
 Ángulo de la punta: 140°
 Ángulo de hélice: 30°

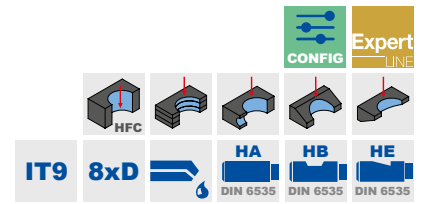
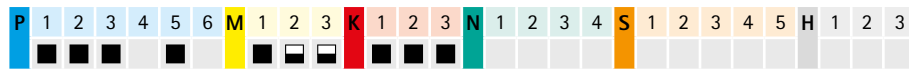
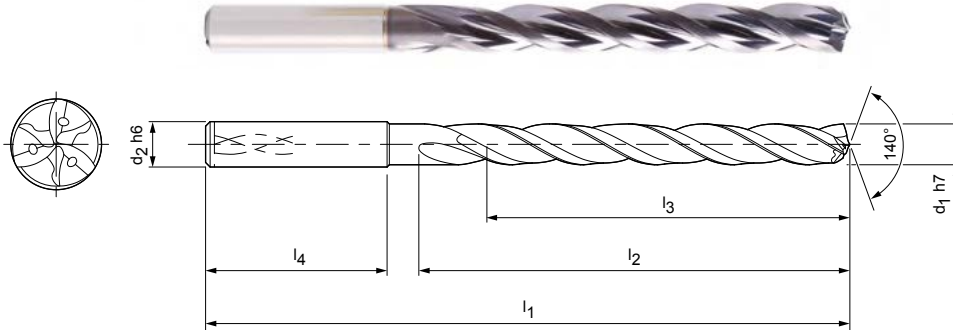

Serie preferente disponible en stock en forma de mango HA

Dimensiones						Forma del mango HA	
d ₁ h7	d ₂ h6	l ₁	l ₂	l ₃	l ₄	Especificación	Referencia
4,00	6	81	43	36	36	SCD661-0400-3-3-140HA08-HP358	30902272
4,10	6	81	43	36	36	SCD661-0410-3-3-140HA08-HP358	30902273
4,20	6	81	43	36	36	SCD661-0420-3-3-140HA08-HP358	30902274
4,30	6	81	43	36	36	SCD661-0430-3-3-140HA08-HP358	30902275
4,50	6	81	43	36	36	SCD661-0450-3-3-140HA08-HP358	30902277
4,60	6	81	43	36	36	SCD661-0460-3-3-140HA08-HP358	30902278
4,70	6	81	43	36	36	SCD661-0470-3-3-140HA08-HP358	30902279
4,80	6	95	57	48	36	SCD661-0480-3-3-140HA08-HP358	30902280
5,00	6	95	57	48	36	SCD661-0500-3-3-140HA08-HP358	30902282
5,10	6	95	57	48	36	SCD661-0510-3-3-140HA08-HP358	30902283
5,20	6	95	57	48	36	SCD661-0520-3-3-140HA08-HP358	30902284
5,40	6	95	57	48	36	SCD661-0540-3-3-140HA08-HP358	30902286
5,50	6	95	57	48	36	SCD661-0550-3-3-140HA08-HP358	30902287
5,60	6	95	57	48	36	SCD661-0560-3-3-140HA08-HP358	30902288
5,80	6	95	57	48	36	SCD661-0580-3-3-140HA08-HP358	30902290
5,90	6	95	57	48	36	SCD661-0590-3-3-140HA08-HP358	30902291
6,00	6	95	57	48	36	SCD661-0600-3-3-140HA08-HP358	30902292
6,10	8	114	76	64	36	SCD661-0610-3-3-140HA08-HP358	30902293
6,50	8	114	76	64	36	SCD661-0650-3-3-140HA08-HP358	30902297
6,60	8	114	76	64	36	SCD661-0660-3-3-140HA08-HP358	30902298
6,80	8	114	76	64	36	SCD661-0680-3-3-140HA08-HP358	30902300
6,90	8	114	76	64	36	SCD661-0690-3-3-140HA08-HP358	30902301
7,00	8	114	76	64	36	SCD661-0700-3-3-140HA08-HP358	30902302
7,50	8	114	76	64	36	SCD661-0750-3-3-140HA08-HP358	30902307
7,80	8	114	76	64	36	SCD661-0780-3-3-140HA08-HP358	30902310
7,90	8	114	76	64	36	SCD661-0790-3-3-140HA08-HP358	30902311
8,00	8	114	76	64	36	SCD661-0800-3-3-140HA08-HP358	30902312
8,10	10	142	95	80	40	SCD661-0810-3-3-140HA08-HP358	30902313
8,20	10	142	95	80	40	SCD661-0820-3-3-140HA08-HP358	30902314
8,50	10	142	95	80	40	SCD661-0850-3-3-140HA08-HP358	30902317
8,60	10	142	95	80	40	SCD661-0860-3-3-140HA08-HP358	30902318
8,80	10	142	95	80	40	SCD661-0880-3-3-140HA08-HP358	30902320
9,00	10	142	95	80	40	SCD661-0900-3-3-140HA08-HP358	30902322
9,10	10	142	95	80	40	SCD661-0910-3-3-140HA08-HP358	30902323
9,50	10	142	95	80	40	SCD661-0950-3-3-140HA08-HP358	30902327

Tritan-Drill-Steel | Broca helicoidal de metal duro SCD661 (8xD), suministro de refrigerante interior

Dimensiones						Forma del mango HA	
d ₁ h7	d ₂ h6	l ₁	l ₂	l ₃	l ₄	Especificación	Referencia
9,80	10	142	95	80	40	SCD661-0980-3-3-140HA08-HP358	30902330
10,00	10	142	95	80	40	SCD661-1000-3-3-140HA08-HP358	30902332
10,20	12	162	114	96	45	SCD661-1020-3-3-140HA08-HP358	30902334
10,30	12	162	114	96	45	SCD661-1030-3-3-140HA08-HP358	30902335
10,50	12	162	114	96	45	SCD661-1050-3-3-140HA08-HP358	30902337
11,00	12	162	114	96	45	SCD661-1100-3-3-140HA08-HP358	30902342
11,50	12	162	114	96	45	SCD661-1150-3-3-140HA08-HP358	30902347
11,80	12	162	114	96	45	SCD661-1180-3-3-140HA08-HP358	30902350
11,90	12	162	114	96	45	SCD661-1190-3-3-140HA08-HP358	30902351
12,00	12	162	114	96	45	SCD661-1200-3-3-140HA08-HP358	30902352
12,20	14	178	133	112	45	SCD661-1220-3-3-140HA08-HP358	30902353
12,50	14	178	133	112	45	SCD661-1250-3-3-140HA08-HP358	30902354
13,00	14	178	133	112	45	SCD661-1300-3-3-140HA08-HP358	30902356
13,50	14	178	133	112	45	SCD661-1350-3-3-140HA08-HP358	30902358
13,80	14	178	133	112	45	SCD661-1380-3-3-140HA08-HP358	30902359
14,00	14	178	133	112	45	SCD661-1400-3-3-140HA08-HP358	30902360
14,20	16	203	152	128	48	SCD661-1420-3-3-140HA08-HP358	30902361
14,50	16	203	152	128	48	SCD661-1450-3-3-140HA08-HP358	30902362
15,00	16	203	152	128	48	SCD661-1500-3-3-140HA08-HP358	30902364
15,50	16	203	152	128	48	SCD661-1550-3-3-140HA08-HP358	30902366
15,80	16	203	152	128	48	SCD661-1580-3-3-140HA08-HP358	30902367
16,00	16	203	152	128	48	SCD661-1600-3-3-140HA08-HP358	30902368
17,00	18	222	171	144	48	SCD661-1700-3-3-140HA08-HP358	30902372
17,50	18	222	171	144	48	SCD661-1750-3-3-140HA08-HP358	30902374
18,00	18	222	171	144	48	SCD661-1800-3-3-140HA08-HP358	30902376
18,50	20	243	190	160	50	SCD661-1850-3-3-140HA08-HP358	30902378
19,00	20	243	190	160	50	SCD661-1900-3-3-140HA08-HP358	30902380
19,20	20	243	190	160	50	SCD661-1920-3-3-140HA08-HP358	30902381
19,50	20	243	190	160	50	SCD661-1950-3-3-140HA08-HP358	30902382
20,00	20	243	190	160	50	SCD661-2000-3-3-140HA08-HP358	30902384

Características configurables

**Diámetro:**

Diámetro seleccionable libremente en incrementos de 0,01 mm

**Forma del mango:**

Forma del mango: HB | HE

Especificación

SCD661-[diámetro]-3-3-140[forma del mango]08-HP358

Dimensiones de la serie configurable

d ₁ min.	d ₁ max.	d ₂ h6	l ₁	l ₂	l ₃	l ₄
4,00	4,70	6	81	43	36	36
4,71	6,00	6	95	57	48	36
6,01	8,00	8	114	76	64	36
8,01	10,00	10	142	95	80	40
10,01	12,00	12	162	114	96	45
12,01	14,00	14	178	133	112	45
14,01	16,00	16	203	152	128	48
16,01	18,00	18	222	171	144	48
18,01	20,00	20	243	190	160	50

Ejemplo:

SCD661-0431-3-3-140HE08-HP358

Forma del mango HE

Diámetro de la herramienta d₁ = 4,31 mm

Medidas en mm.

Para la recomendación de valores de corte, véase al final del capítulo.

Ejecuciones especiales y otros recubrimientos a petición.

Tritan-Drill-Steel

Broca helicoidal de metal duro
SCD661 (12xD), suministro de refrigerante interior

Ejecución:
 Diámetro de broca: 4,00 – 20,00 mm
 Tolerancia del agujero: $\geq IT 9$
 Material de corte: HP358
 Número de insertos: 3
 Número de biseles guía: 3
 Ángulo de la punta: 140°
 Ángulo de hélice: 30°

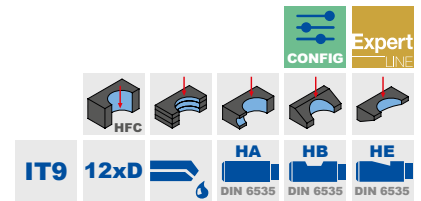
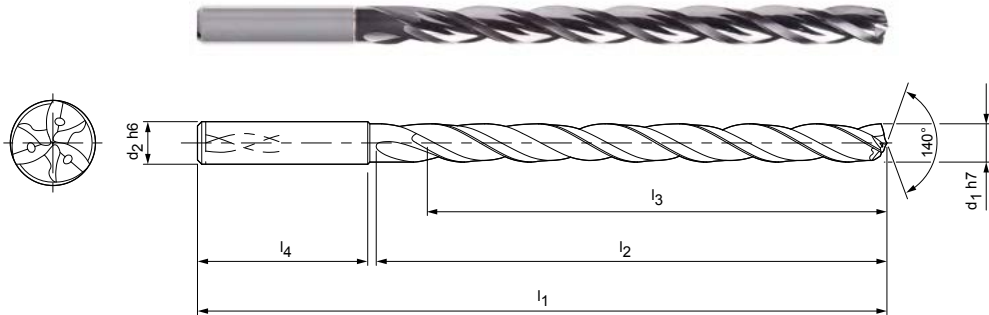

Serie preferente disponible en stock en forma de mango HA

Dimensiones						Forma del mango HA	
d ₁ h7	d ₂ h6	l ₁	l ₂	l ₃	l ₄	Especificación	Referencia
4,00	6	102	64	58	36	SCD661-0400-3-3-140HA12-HP358	30902385
4,10	6	102	64	58	36	SCD661-0410-3-3-140HA12-HP358	30902386
4,20	6	102	64	58	36	SCD661-0420-3-3-140HA12-HP358	30902387
4,30	6	102	64	58	36	SCD661-0430-3-3-140HA12-HP358	30902388
4,50	6	102	64	58	36	SCD661-0450-3-3-140HA12-HP358	30902390
4,60	6	102	64	58	36	SCD661-0460-3-3-140HA12-HP358	30902391
4,80	6	116	78	70	36	SCD661-0480-3-3-140HA12-HP358	30902393
5,00	6	116	78	70	36	SCD661-0500-3-3-140HA12-HP358	30902395
5,10	6	116	78	70	36	SCD661-0510-3-3-140HA12-HP358	30902396
5,20	6	116	78	70	36	SCD661-0520-3-3-140HA12-HP358	30902397
5,40	6	116	78	70	36	SCD661-0540-3-3-140HA12-HP358	30902399
5,50	6	116	78	70	36	SCD661-0550-3-3-140HA12-HP358	30902400
5,80	6	116	78	70	36	SCD661-0580-3-3-140HA12-HP358	30902403
5,90	6	116	78	70	36	SCD661-0590-3-3-140HA12-HP358	30902404
6,00	6	116	78	70	36	SCD661-0600-3-3-140HA12-HP358	30902405
6,10	8	146	108	94	36	SCD661-0610-3-3-140HA12-HP358	30902406
6,50	8	146	108	94	36	SCD661-0650-3-3-140HA12-HP358	30902410
6,80	8	146	108	94	36	SCD661-0680-3-3-140HA12-HP358	30902413
7,00	8	146	108	94	36	SCD661-0700-3-3-140HA12-HP358	30902415
7,50	8	146	108	94	36	SCD661-0750-3-3-140HA12-HP358	30902420
7,80	8	146	108	94	36	SCD661-0780-3-3-140HA12-HP358	30902423
7,90	8	146	108	94	36	SCD661-0790-3-3-140HA12-HP358	30902424
8,00	8	146	108	94	36	SCD661-0800-3-3-140HA12-HP358	30902425
8,20	10	162	120	110	40	SCD661-0820-3-3-140HA12-HP358	30902427
8,40	10	162	120	110	40	SCD661-0840-3-3-140HA12-HP358	30902429
8,50	10	162	120	110	40	SCD661-0850-3-3-140HA12-HP358	30902430
8,80	10	162	120	110	40	SCD661-0880-3-3-140HA12-HP358	30902433
9,00	10	162	120	110	40	SCD661-0900-3-3-140HA12-HP358	30902435
9,50	10	162	120	110	40	SCD661-0950-3-3-140HA12-HP358	30902440
9,60	10	162	120	110	40	SCD661-0960-3-3-140HA12-HP358	30902441
9,80	10	162	120	110	40	SCD661-0980-3-3-140HA12-HP358	30902443
10,00	10	162	120	110	40	SCD661-1000-3-3-140HA12-HP358	30902445
10,20	12	204	156	142	45	SCD661-1020-3-3-140HA12-HP358	30902447
10,30	12	204	156	142	45	SCD661-1030-3-3-140HA12-HP358	30902448
10,50	12	204	156	142	45	SCD661-1050-3-3-140HA12-HP358	30902450

Tritan-Drill-Steel | Broca helicoidal de metal duro SCD661 (12xD), suministro de refrigerante interior

Dimensiones						Forma del mango HA	
d ₁ h7	d ₂ h6	l ₁	l ₂	l ₃	l ₄	Especificación	Referencia
11,00	12	204	156	142	45	SCD661-1100-3-3-140HA12-HP358	30902455
11,50	12	204	156	142	45	SCD661-1150-3-3-140HA12-HP358	30902460
11,80	12	204	156	142	45	SCD661-1180-3-3-140HA12-HP358	30902463
12,00	12	204	156	142	45	SCD661-1200-3-3-140HA12-HP358	30902465
12,50	14	230	182	166	45	SCD661-1250-3-3-140HA12-HP358	30902467
13,00	14	230	182	166	45	SCD661-1300-3-3-140HA12-HP358	30902469
13,50	14	230	182	166	45	SCD661-1350-3-3-140HA12-HP358	30902471
14,00	14	230	182	166	45	SCD661-1400-3-3-140HA12-HP358	30902473
14,50	16	260	208	192	48	SCD661-1450-3-3-140HA12-HP358	30902475
15,00	16	260	208	192	48	SCD661-1500-3-3-140HA12-HP358	30902477
15,50	16	260	208	192	48	SCD661-1550-3-3-140HA12-HP358	30902479
16,00	16	260	208	192	48	SCD661-1600-3-3-140HA12-HP358	30902481
16,50	18	285	234	216	48	SCD661-1650-3-3-140HA12-HP358	30902483
17,00	18	285	234	216	48	SCD661-1700-3-3-140HA12-HP358	30902485
17,50	18	285	234	216	48	SCD661-1750-3-3-140HA12-HP358	30902487
18,00	18	285	234	216	48	SCD661-1800-3-3-140HA12-HP358	30902489
18,50	20	310	258	240	50	SCD661-1850-3-3-140HA12-HP358	30902491
19,00	20	310	258	240	50	SCD661-1900-3-3-140HA12-HP358	30902493
19,50	20	310	258	240	50	SCD661-1950-3-3-140HA12-HP358	30902495
20,00	20	310	258	240	50	SCD661-2000-3-3-140HA12-HP358	30902497

Características configurables



Diámetro:
Diámetro seleccionable libremente en incrementos de 0,01 mm





Forma del mango:
Forma del mango: HB | HE

Especificación
SCD661-[diámetro]-3-3-140[forma del mango]12-HP358

Dimensiones de la serie configurable

d ₁ min.	d ₁ max.	d ₂ h6	l ₁	l ₂	l ₃	l ₄
4,00	4,70	6	102	64	58	36
4,71	6,00	6	116	78	70	36
6,01	8,00	8	146	108	94	36
8,01	10,00	10	162	120	110	40
10,01	12,00	12	204	156	142	45
12,01	14,00	14	230	182	166	45
14,01	16,00	16	260	208	192	48
16,01	18,00	18	285	234	216	48
18,01	20,00	20	310	258	240	50

Ejemplo:

SCD661-0431-3-3-140HE12-HP358

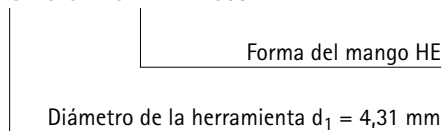

Medidas en mm.

Para la recomendación de valores de corte, véase al final del capítulo.

Ejecuciones especiales y otros recubrimientos a petición.

MEGA-Speed-Drill-Steel

Broca helicoidal de metal duro

SCD621 (3xD), suministro de refrigerante interior, producto sucesor de la MEGA-Speed-Drill-Steel (SCD22)

Ejecución:

Diámetro de broca: 3,00 – 20,00 mm
 Tolerancia del agujero: IT 9 (alcanzable)
 Material de corte: HP358
 Número de insertos: 2
 Número de bisel guía: 3
 Ángulo de la punta: 145°
 Ángulo de hélice: 30°

Aplicación:

Para el mecanizado de alta velocidad.

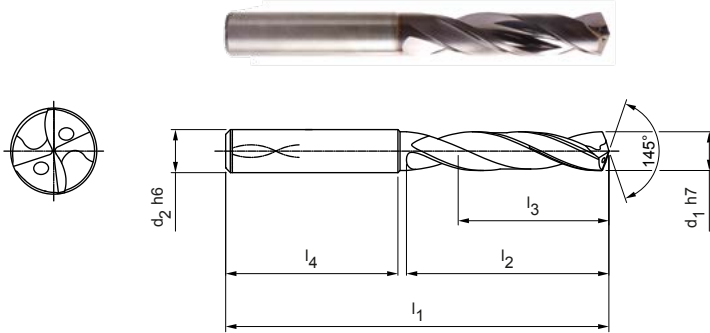

Serie preferente disponible en stock en forma de mango HA

Dimensiones						Forma del mango HA	
d ₁ h7	d ₂ h6	l ₁	l ₂	l ₃	l ₄	Especificación	Referencia
3,00	6	62	20	14	36	SCD621-0300-2-3-145HA03-HP358	31036265
3,20	6	62	20	14	36	SCD621-0320-2-3-145HA03-HP358	31036267
3,30	6	62	20	14	36	SCD621-0330-2-3-145HA03-HP358	31036268
3,40	6	62	20	14	36	SCD621-0340-2-3-145HA03-HP358	31036269
3,50	6	62	20	14	36	SCD621-0350-2-3-145HA03-HP358	31036270
3,70	6	62	20	14	36	SCD621-0370-2-3-145HA03-HP358	31036272
3,80	6	66	24	17	36	SCD621-0380-2-3-145HA03-HP358	31036273
3,90	6	66	24	17	36	SCD621-0390-2-3-145HA03-HP358	31036274
4,00	6	66	24	17	36	SCD621-0400-2-3-145HA03-HP358	31036275
4,10	6	66	24	17	36	SCD621-0410-2-3-145HA03-HP358	31036276
4,20	6	66	24	17	36	SCD621-0420-2-3-145HA03-HP358	31036277
4,30	6	66	24	17	36	SCD621-0430-2-3-145HA03-HP358	31036278
4,50	6	66	24	17	36	SCD621-0450-2-3-145HA03-HP358	31036280
4,60	6	66	24	17	36	SCD621-0460-2-3-145HA03-HP358	31036281
4,65	6	66	24	17	36	SCD621-0465-2-3-145HA03-HP358	31307528
4,70	6	66	24	17	36	SCD621-0470-2-3-145HA03-HP358	31036282
4,90	6	66	28	20	36	SCD621-0490-2-3-145HA03-HP358	31036284
5,00	6	66	28	20	36	SCD621-0500-2-3-145HA03-HP358	31036285
5,10	6	66	28	20	36	SCD621-0510-2-3-145HA03-HP358	31036286
5,20	6	66	28	20	36	SCD621-0520-2-3-145HA03-HP358	31036287
5,50	6	66	28	20	36	SCD621-0550-2-3-145HA03-HP358	31036290
5,60	6	66	28	20	36	SCD621-0560-2-3-145HA03-HP358	31036291
5,80	6	66	28	20	36	SCD621-0580-2-3-145HA03-HP358	31036293
5,90	6	66	28	20	36	SCD621-0590-2-3-145HA03-HP358	31036294
6,00	6	66	28	20	36	SCD621-0600-2-3-145HA03-HP358	31036295
6,10	8	79	34	24	36	SCD621-0610-2-3-145HA03-HP358	31036296
6,20	8	79	34	24	36	SCD621-0620-2-3-145HA03-HP358	31036297
6,30	8	79	34	24	36	SCD621-0630-2-3-145HA03-HP358	31036298
6,40	8	79	34	24	36	SCD621-0640-2-3-145HA03-HP358	31036299
6,50	8	79	34	24	36	SCD621-0650-2-3-145HA03-HP358	31036300
6,60	8	79	34	24	36	SCD621-0660-2-3-145HA03-HP358	31036301
6,80	8	79	34	24	36	SCD621-0680-2-3-145HA03-HP358	31036303
6,90	8	79	34	24	36	SCD621-0690-2-3-145HA03-HP358	31036304
7,00	8	79	34	24	36	SCD621-0700-2-3-145HA03-HP358	31036305
7,15	8	79	41	29	36	SCD621-0715-2-3-145HA03-HP358	31307529

Continúa en la página siguiente.

MEGA-Speed-Drill-Steel | Broca helicoidal de metal duro SCD621 (3xD), suministro de refrigerante interior

Dimensiones						Forma del mango HA	
d ₁ h7	d ₂ h6	l ₁	l ₂	l ₃	l ₄	Especificación	Referencia
7,30	8	79	41	29	36	SCD621-0730-2-3-145HA03-HP358	31036308
7,40	8	79	41	29	36	SCD621-0740-2-3-145HA03-HP358	31036309
7,50	8	79	41	29	36	SCD621-0750-2-3-145HA03-HP358	31036310
7,60	8	79	41	29	36	SCD621-0760-2-3-145HA03-HP358	31036311
7,70	8	79	41	29	36	SCD621-0770-2-3-145HA03-HP358	31036312
7,80	8	79	41	29	36	SCD621-0780-2-3-145HA03-HP358	31036313
8,00	8	79	41	29	36	SCD621-0800-2-3-145HA03-HP358	31036315
8,20	10	89	47	35	40	SCD621-0820-2-3-145HA03-HP358	31036317
8,50	10	89	47	35	40	SCD621-0850-2-3-145HA03-HP358	31036320
8,60	10	89	47	35	40	SCD621-0860-2-3-145HA03-HP358	31036321
8,70	10	89	47	35	40	SCD621-0870-2-3-145HA03-HP358	31036322
8,80	10	89	47	35	40	SCD621-0880-2-3-145HA03-HP358	31036323
8,90	10	89	47	35	40	SCD621-0890-2-3-145HA03-HP358	31036324
9,00	10	89	47	35	40	SCD621-0900-2-3-145HA03-HP358	31036325
9,10	10	89	47	35	40	SCD621-0910-2-3-145HA03-HP358	31036326
9,20	10	89	47	35	40	SCD621-0920-2-3-145HA03-HP358	31036327
9,30	10	89	47	35	40	SCD621-0930-2-3-145HA03-HP358	31036328
9,40	10	89	47	35	40	SCD621-0940-2-3-145HA03-HP358	31036329
9,50	10	89	47	35	40	SCD621-0950-2-3-145HA03-HP358	31036330
9,60	10	89	47	35	40	SCD621-0960-2-3-145HA03-HP358	31036331
9,80	10	89	47	35	40	SCD621-0980-2-3-145HA03-HP358	31036333
9,90	10	89	47	35	40	SCD621-0990-2-3-145HA03-HP358	31036334
10,00	10	89	47	35	40	SCD621-1000-2-3-145HA03-HP358	31036335
10,20	12	102	55	40	45	SCD621-1020-2-3-145HA03-HP358	31036337
10,30	12	102	55	40	45	SCD621-1030-2-3-145HA03-HP358	31036338
10,50	12	102	55	40	45	SCD621-1050-2-3-145HA03-HP358	31036340
11,00	12	102	55	40	45	SCD621-1100-2-3-145HA03-HP358	31036345
11,20	12	102	55	40	45	SCD621-1120-2-3-145HA03-HP358	31036347
11,50	12	102	55	40	45	SCD621-1150-2-3-145HA03-HP358	31036350
11,80	12	102	55	40	45	SCD621-1180-2-3-145HA03-HP358	31036353
11,90	12	102	55	40	45	SCD621-1190-2-3-145HA03-HP358	31036354
12,00	12	102	55	40	45	SCD621-1200-2-3-145HA03-HP358	31036355
13,00	14	107	60	43	45	SCD621-1300-2-3-145HA03-HP358	31036359
13,80	14	107	60	43	45	SCD621-1380-2-3-145HA03-HP358	31036361
14,00	14	107	60	43	45	SCD621-1400-2-3-145HA03-HP358	31036362
14,50	16	115	65	45	48	SCD621-1450-2-3-145HA03-HP358	31036364
15,00	16	115	65	45	48	SCD621-1500-2-3-145HA03-HP358	31036366
16,00	16	115	65	45	48	SCD621-1600-2-3-145HA03-HP358	31036370
17,00	18	123	73	51	48	SCD621-1700-2-3-145HA03-HP358	31036373
17,50	18	123	73	51	48	SCD621-1750-2-3-145HA03-HP358	31036374
18,00	18	123	73	51	48	SCD621-1800-2-3-145HA03-HP358	31036376
18,50	20	131	79	55	50	SCD621-1850-2-3-145HA03-HP358	31036377
20,00	20	131	79	55	50	SCD621-2000-2-3-145HA03-HP358	31036392

MEGA-Speed-Drill-Steel | Broca helicoidal de metal duro SCD621 (3xD), suministro de refrigerante interior

Características configurables

**Diámetro:**

Diámetro seleccionable libremente en incrementos de 0,01 mm

**Forma del mango:**

Forma del mango HB | HE

Especificación

SCD621-[diámetro]-2-3-145[forma del mango]03-HP358

Dimensiones de la serie configurable

d ₁ min.	d ₁ max.	d ₂ h6	l ₁	l ₂	l ₃	l ₄
3,00	3,70	6	62	20	14	36
3,71	4,70	6	66	24	17	36
4,71	6,00	6	66	28	20	36
6,01	6,80	8	79	34	24	36
6,81	8,00	8	79	41	29	36
8,01	10,00	10	89	47	35	40
10,01	12,00	12	102	55	40	45
12,01	14,00	14	107	60	43	45
14,01	16,00	16	115	65	45	48
16,01	18,00	18	123	73	51	48
18,01	20,00	20	131	79	55	50

Ejemplo:

SCD621-0431-2-3-145HE03-HP358

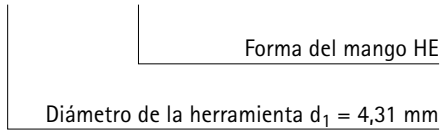

Medidas en mm.

Para la recomendación de valores de corte, véase al final del capítulo.

Ejecuciones especiales y otros recubrimientos a petición.

MEGA-Speed-Drill-Steel

Broca helicoidal de metal duro
SCD621 (5xD), suministro de refrigerante interior, producto sucesor de la MEGA-Speed-Drill-Steel (SCD22)

Ejecución:
 Diámetro de broca: 3,00 – 20,00 mm
 Tolerancia del agujero: \geq IT 9
 Material de corte: HP358
 Número de insertos: 2
 Número de bisel guía: 3
 Ángulo de la punta: 145°
 Ángulo de hélice: 30°

Aplicación:
 Para el mecanizado de alta velocidad.

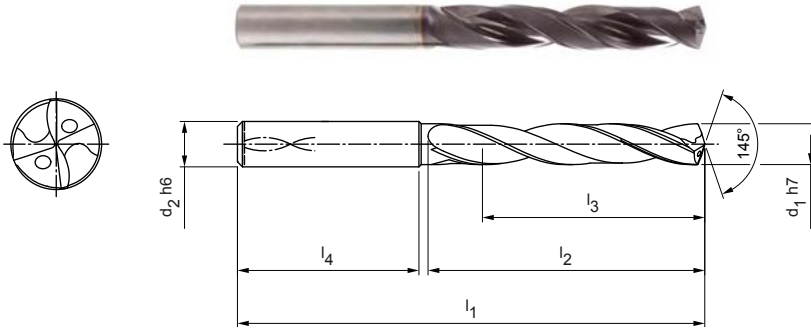

Serie preferente disponible en stock en forma de mango HA

Dimensiones						Forma del mango HA	
d ₁ h7	d ₂ h6	l ₁	l ₂	l ₃	l ₄	Especificación	Referencia
3,00	6	66	28	23	36	SCD621-0300-2-3-145HA05-HP358	30966287
3,10	6	66	28	23	36	SCD621-0310-2-3-145HA05-HP358	30966288
3,20	6	66	28	23	36	SCD621-0320-2-3-145HA05-HP358	30966289
3,30	6	66	28	23	36	SCD621-0330-2-3-145HA05-HP358	30966310
3,40	6	66	28	23	36	SCD621-0340-2-3-145HA05-HP358	30966311
3,50	6	66	28	23	36	SCD621-0350-2-3-145HA05-HP358	30959126
3,70	6	66	28	23	36	SCD621-0370-2-3-145HA05-HP358	30966313
3,80	6	74	36	29	36	SCD621-0380-2-3-145HA05-HP358	30966314
4,00	6	74	36	29	36	SCD621-0400-2-3-145HA05-HP358	30966316
4,20	6	74	36	29	36	SCD621-0420-2-3-145HA05-HP358	30966318
4,30	6	74	36	29	36	SCD621-0430-2-3-145HA05-HP358	30966319
4,50	6	74	36	29	36	SCD621-0450-2-3-145HA05-HP358	30966321
4,65	6	74	36	29	36	SCD621-0465-2-3-145HA05-HP358	31307540
4,70	6	74	36	29	36	SCD621-0470-2-3-145HA05-HP358	30966323
4,80	6	82	44	35	36	SCD621-0480-2-3-145HA05-HP358	30966324
4,90	6	82	44	35	36	SCD621-0490-2-3-145HA05-HP358	30966326
5,00	6	82	44	35	36	SCD621-0500-2-3-145HA05-HP358	30966327
5,10	6	82	44	35	36	SCD621-0510-2-3-145HA05-HP358	30966328
5,20	6	82	44	35	36	SCD621-0520-2-3-145HA05-HP358	30966329
5,30	6	82	44	35	36	SCD621-0530-2-3-145HA05-HP358	30966330
5,40	6	82	44	35	36	SCD621-0540-2-3-145HA05-HP358	30966331
5,50	6	82	44	35	36	SCD621-0550-2-3-145HA05-HP358	30966332
5,55	6	82	44	35	36	SCD621-0555-2-3-145HA05-HP358	31307541
5,60	6	82	44	35	36	SCD621-0560-2-3-145HA05-HP358	30966333
5,70	6	82	44	35	36	SCD621-0570-2-3-145HA05-HP358	30966334
5,80	6	82	44	35	36	SCD621-0580-2-3-145HA05-HP358	30966335
5,90	6	82	44	35	36	SCD621-0590-2-3-145HA05-HP358	30966336
6,00	6	82	44	35	36	SCD621-0600-2-3-145HA05-HP358	30966337
6,10	8	91	53	43	36	SCD621-0610-2-3-145HA05-HP358	30966338
6,20	8	91	53	43	36	SCD621-0620-2-3-145HA05-HP358	30966339
6,30	8	91	53	43	36	SCD621-0630-2-3-145HA05-HP358	30966340
6,50	8	91	53	43	36	SCD621-0650-2-3-145HA05-HP358	30966342
6,70	8	91	53	43	36	SCD621-0670-2-3-145HA05-HP358	30966344
6,80	8	91	53	43	36	SCD621-0680-2-3-145HA05-HP358	30966345

MEGA-Speed-Drill-Steel | Broca helicoidal de metal duro SCD621 (5xD), suministro de refrigerante interior

Dimensiones						Forma del mango HA	
d ₁ h7	d ₂ h6	l ₁	l ₂	l ₃	l ₄	Especificación	Referencia
6,90	8	91	53	43	36	SCD621-0690-2-3-145HA05-HP358	30966346
7,00	8	91	53	43	36	SCD621-0700-2-3-145HA05-HP358	30966347
7,10	8	91	53	43	36	SCD621-0710-2-3-145HA05-HP358	30966348
7,20	8	91	53	43	36	SCD621-0720-2-3-145HA05-HP358	30966349
7,30	8	91	53	43	36	SCD621-0730-2-3-145HA05-HP358	30966350
7,40	8	91	53	43	36	SCD621-0740-2-3-145HA05-HP358	30966351
7,50	8	91	53	43	36	SCD621-0750-2-3-145HA05-HP358	30966352
7,60	8	91	53	43	36	SCD621-0760-2-3-145HA05-HP358	30966353
7,80	8	91	53	43	36	SCD621-0780-2-3-145HA05-HP358	30966355
8,00	8	91	53	43	36	SCD621-0800-2-3-145HA05-HP358	30948674
8,10	10	103	61	49	40	SCD621-0810-2-3-145HA05-HP358	30966357
8,20	10	103	61	49	40	SCD621-0820-2-3-145HA05-HP358	30966358
8,30	10	103	61	49	40	SCD621-0830-2-3-145HA05-HP358	30966359
8,40	10	103	61	49	40	SCD621-0840-2-3-145HA05-HP358	30966360
8,50	10	103	61	49	40	SCD621-0850-2-3-145HA05-HP358	30959302
8,60	10	103	61	49	40	SCD621-0860-2-3-145HA05-HP358	30966361
8,70	10	89	47	35	40	SCD621-0870-2-3-145HA05-HP358	30812607
8,80	10	103	61	49	40	SCD621-0880-2-3-145HA05-HP358	30966362
9,00	10	103	61	49	40	SCD621-0900-2-3-145HA05-HP358	30966364
9,10	10	103	61	49	40	SCD621-0910-2-3-145HA05-HP358	30966365
9,30	10	103	61	49	40	SCD621-0930-2-3-145HA05-HP358	30966367
9,40	10	103	61	49	40	SCD621-0940-2-3-145HA05-HP358	30966368
9,50	10	103	61	49	40	SCD621-0950-2-3-145HA05-HP358	30966369
9,70	10	103	61	49	40	SCD621-0970-2-3-145HA05-HP358	30958145
9,80	10	103	61	49	40	SCD621-0980-2-3-145HA05-HP358	30959402
9,90	10	103	61	49	40	SCD621-0990-2-3-145HA05-HP358	30966371
10,00	10	103	61	49	40	SCD621-1000-2-3-145HA05-HP358	30948675
10,20	12	118	71	56	45	SCD621-1020-2-3-145HA05-HP358	30966373
10,30	12	118	71	56	45	SCD621-1030-2-3-145HA05-HP358	30966374
10,50	12	118	71	56	45	SCD621-1050-2-3-145HA05-HP358	30966376
11,00	12	118	71	56	45	SCD621-1100-2-3-145HA05-HP358	30966381
11,10	12	118	71	56	45	SCD621-1110-2-3-145HA05-HP358	30966382
11,20	12	118	71	56	45	SCD621-1120-2-3-145HA05-HP358	30966383
11,30	12	118	71	56	45	SCD621-1130-2-3-145HA05-HP358	30966384
11,40	12	118	71	56	45	SCD621-1140-2-3-145HA05-HP358	30966385
11,50	12	118	71	56	45	SCD621-1150-2-3-145HA05-HP358	30966386
11,60	12	118	71	56	45	SCD621-1160-2-3-145HA05-HP358	30966387
11,80	12	118	71	56	45	SCD621-1180-2-3-145HA05-HP358	30966389
11,90	12	118	71	56	45	SCD621-1190-2-3-145HA05-HP358	30966390
12,00	12	118	71	56	45	SCD621-1200-2-3-145HA05-HP358	30948676
12,20	14	124	77	60	45	SCD621-1220-2-3-145HA05-HP358	30966391
12,50	14	124	77	60	45	SCD621-1250-2-3-145HA05-HP358	30966392
12,80	14	124	77	60	45	SCD621-1280-2-3-145HA05-HP358	30980599
13,00	14	124	77	60	45	SCD621-1300-2-3-145HA05-HP358	30966393
13,50	14	124	77	60	45	SCD621-1350-2-3-145HA05-HP358	30966394
13,80	14	124	77	60	45	SCD621-1380-2-3-145HA05-HP358	30966395
14,00	14	124	77	60	45	SCD621-1400-2-3-145HA05-HP358	30966396
14,20	16	133	83	63	48	SCD621-1420-2-3-145HA05-HP358	30966397
14,50	16	133	83	63	48	SCD621-1450-2-3-145HA05-HP358	30966398
15,00	16	133	83	63	48	SCD621-1500-2-3-145HA05-HP358	30966400
15,20	16	133	83	63	48	SCD621-1520-2-3-145HA05-HP358	30966401
15,50	16	133	83	63	48	SCD621-1550-2-3-145HA05-HP358	30966402
16,00	16	133	83	63	48	SCD621-1600-2-3-145HA05-HP358	30966404
16,50	18	143	93	71	48	SCD621-1650-2-3-145HA05-HP358	30966405
17,00	18	143	93	71	48	SCD621-1700-2-3-145HA05-HP358	30966407
17,50	18	143	93	71	48	SCD621-1750-2-3-145HA05-HP358	30966408

Continúa en la página siguiente.

MEGA-Speed-Drill-Steel | Broca helicoidal de metal duro SCD621 (5xD), suministro de refrigerante interior

Dimensiones						Forma del mango HA	
d ₁ h7	d ₂ h6	l ₁	l ₂	l ₃	l ₄	Especificación	Referencia
18,00	18	143	93	71	48	SCD621-1800-2-3-145HA05-HP358	30966410
18,50	20	153	101	77	50	SCD621-1850-2-3-145HA05-HP358	30966411
19,80	20	153	101	77	50	SCD621-1980-2-3-145HA05-HP358	30966415
20,00	20	153	101	77	50	SCD621-2000-2-3-145HA05-HP358	30966416

Características configurables

**Diámetro:**

Diámetro seleccionable libremente en incrementos de 0,01 mm

**Forma del mango:**

Forma del mango: HB | HE

Especificación

SCD621-[diámetro]-2-3-145[forma del mango]05-HP358

Ejemplo:

SCD621-0431-2-3-145HE05-HP358

Forma del mango HE

Diámetro de la herramienta d₁ = 4,31 mm

Dimensiones de la serie configurable

d ₁ min.	d ₁ max.	d ₂ h6	l ₁	l ₂	l ₃	l ₄
3,00	3,70	6	66	28	23	36
3,71	4,70	6	74	36	29	36
4,71	6,00	6	82	44	35	36
6,01	6,80	8	91	53	43	36
6,81	8,00	8	91	53	43	36
8,01	9,00	10	103	61	49	40
9,01	10,00	10	103	61	49	40
10,01	11,00	12	118	71	56	45
11,01	12,00	12	118	71	56	45
12,01	14,00	14	124	77	60	45
14,01	16,00	16	133	83	63	48
16,01	18,00	18	143	93	71	48
18,01	20,00	20	153	101	77	50

Medidas en mm.

Para la recomendación de valores de corte, véase al final del capítulo.

Ejecuciones especiales y otros recubrimientos a petición.

MEGA-Speed-Drill-Steel

Broca helicoidal de metal duro

SCD621 (8xD), suministro de refrigerante interior, producto sucesor de la MEGA-Speed-Drill-Steel (SCD22)

Ejecución:

Diámetro de broca: 3,00 – 20,00 mm
 Tolerancia del agujero: IT 9 (alcanzable)
 Material de corte: HP358
 Número de insertos: 2
 Número de biseles guía: 3
 Ángulo de la punta: 145°
 Ángulo de hélice: 30°

Aplicación:

Para el mecanizado de alta velocidad.

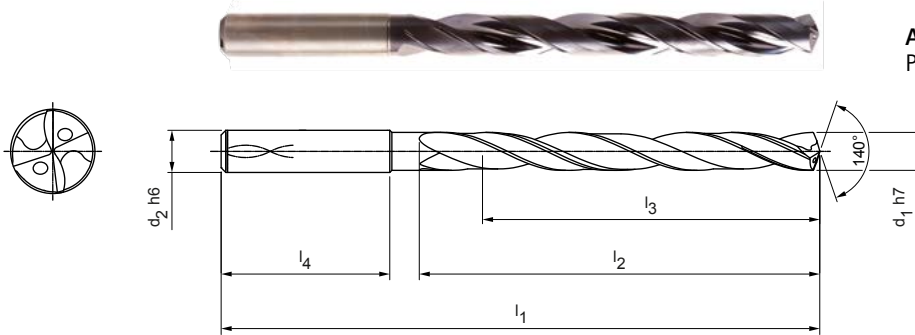

Serie preferente disponible en stock en forma de mango HA

Dimensiones						Forma del mango HA	
d ₁ h7	d ₂ h6	l ₁	l ₂	l ₃	l ₄	Especificación	Referencia
3,00	6	72	34	29	36	SCD621-0300-2-3-145HA08-HP358	31036147
3,10	6	72	34	29	36	SCD621-0310-2-3-145HA08-HP358	31036148
3,20	6	72	34	29	36	SCD621-0320-2-3-145HA08-HP358	31036149
3,30	6	72	34	29	36	SCD621-0330-2-3-145HA08-HP358	31036150
3,40	6	72	34	29	36	SCD621-0340-2-3-145HA08-HP358	31036151
3,50	6	72	34	29	36	SCD621-0350-2-3-145HA08-HP358	31036152
3,70	6	72	34	29	36	SCD621-0370-2-3-145HA08-HP358	31036154
4,00	6	81	43	36	36	SCD621-0400-2-3-145HA08-HP358	31036157
4,10	6	81	43	36	36	SCD621-0410-2-3-145HA08-HP358	31036158
4,20	6	81	43	36	36	SCD621-0420-2-3-145HA08-HP358	31036159
4,30	6	81	43	36	36	SCD621-0430-2-3-145HA08-HP358	31036160
4,50	6	81	43	36	36	SCD621-0450-2-3-145HA08-HP358	31036162
4,65	6	81	43	36	36	SCD621-0465-2-3-145HA08-HP358	31307542
4,80	6	95	57	48	36	SCD621-0480-2-3-145HA08-HP358	31036165
4,90	6	95	57	48	36	SCD621-0490-2-3-145HA08-HP358	31036166
5,00	6	95	57	48	36	SCD621-0500-2-3-145HA08-HP358	31036167
5,10	6	95	57	48	36	SCD621-0510-2-3-145HA08-HP358	31036168
5,20	6	95	57	48	36	SCD621-0520-2-3-145HA08-HP358	31036169
5,40	6	95	57	48	36	SCD621-0540-2-3-145HA08-HP358	31036171
5,50	6	95	57	48	36	SCD621-0550-2-3-145HA08-HP358	31036172
5,55	6	95	57	48	36	SCD621-0555-2-3-145HA08-HP358	31307543
5,60	6	95	57	48	36	SCD621-0560-2-3-145HA08-HP358	31036173
5,80	6	95	57	48	36	SCD621-0580-2-3-145HA08-HP358	31036175
5,90	6	95	57	48	36	SCD621-0590-2-3-145HA08-HP358	31036176
6,00	6	95	57	48	36	SCD621-0600-2-3-145HA08-HP358	31036177
6,10	8	114	76	64	36	SCD621-0610-2-3-145HA08-HP358	31036178
6,20	8	114	76	64	36	SCD621-0620-2-3-145HA08-HP358	31036179
6,50	8	114	76	64	36	SCD621-0650-2-3-145HA08-HP358	31036182
6,80	8	114	76	64	36	SCD621-0680-2-3-145HA08-HP358	31036185
6,90	8	114	76	64	36	SCD621-0690-2-3-145HA08-HP358	31036186
7,00	8	114	76	64	36	SCD621-0700-2-3-145HA08-HP358	31036187
7,50	8	114	76	64	36	SCD621-0750-2-3-145HA08-HP358	31036192
7,80	8	114	76	64	36	SCD621-0780-2-3-145HA08-HP358	31036195
8,00	8	114	76	64	36	SCD621-0800-2-3-145HA08-HP358	31036197
8,10	10	142	95	80	40	SCD621-0810-2-3-145HA08-HP358	31036198

Continúa en la página siguiente.

MEGA-Speed-Drill-Steel | Broca helicoidal de metal duro SCD621 (8xD), suministro de refrigerante interior

Dimensiones						Forma del mango HA	
d ₁ h7	d ₂ h6	l ₁	l ₂	l ₃	l ₄	Especificación	Referencia
8,50	10	142	95	80	40	SCD621-0850-2-3-145HA08-HP358	31036202
9,00	10	142	95	80	40	SCD621-0900-2-3-145HA08-HP358	31036207
9,50	10	142	95	80	40	SCD621-0950-2-3-145HA08-HP358	31036212
9,80	10	142	95	80	40	SCD621-0980-2-3-145HA08-HP358	31036215
10,00	10	142	95	80	40	SCD621-1000-2-3-145HA08-HP358	31036217
10,20	12	162	114	96	45	SCD621-1020-2-3-145HA08-HP358	31036219
10,30	12	162	114	96	45	SCD621-1030-2-3-145HA08-HP358	31036220
10,50	12	162	114	96	45	SCD621-1050-2-3-145HA08-HP358	31036222
11,00	12	162	114	96	45	SCD621-1100-2-3-145HA08-HP358	31036227
11,80	12	162	114	96	45	SCD621-1180-2-3-145HA08-HP358	31036235
12,00	12	162	114	96	45	SCD621-1200-2-3-145HA08-HP358	31036237
12,50	14	178	133	112	45	SCD621-1250-2-3-145HA08-HP358	31036239
13,00	14	178	133	112	45	SCD621-1300-2-3-145HA08-HP358	31036241
13,50	14	178	133	112	45	SCD621-1350-2-3-145HA08-HP358	31036242
14,00	14	178	133	112	45	SCD621-1400-2-3-145HA08-HP358	31036244
15,00	16	203	152	128	48	SCD621-1500-2-3-145HA08-HP358	31036248
15,80	16	203	152	128	48	SCD621-1580-2-3-145HA08-HP358	31036251
16,00	16	203	152	128	48	SCD621-1600-2-3-145HA08-HP358	31036252
19,00	20	243	190	160	50	SCD621-1900-2-3-145HA08-HP358	31036261
19,80	20	243	190	160	50	SCD621-1980-2-3-145HA08-HP358	31036263

Características configurables

**Diámetro:**

Diámetro seleccionable libremente en incrementos de 0,01 mm

**Forma del mango:**

Forma del mango: HB | HE

Especificación

SCD621-[diámetro]-2-3-145[forma del mango]08-HP358

Ejemplo:

SCD621-0431-2-3-145HE08-HP358

Forma del mango HE

Diámetro de la herramienta d₁ = 4,31 mm

Dimensiones de la serie configurable

d ₁ min.	d ₁ max.	d ₂ h6	l ₁	l ₂	l ₃	l ₄
3,00	3,70	6	72	34	29	36
3,71	4,70	6	81	43	36	36
4,71	6,00	6	95	57	48	36
6,01	6,80	8	114	76	64	36
6,81	8,00	8	114	76	64	36
8,01	9,00	10	142	95	80	40
9,01	10,00	10	142	95	80	40
10,01	11,00	12	162	114	96	45
11,01	12,00	12	162	114	96	45
12,01	14,00	14	178	133	112	45
14,01	16,00	16	203	152	128	48
16,01	18,00	18	222	171	144	48
18,01	20,00	20	243	190	160	50

Medidas en mm.

Para la recomendación de valores de corte, véase al final del capítulo.

Ejecuciones especiales y otros recubrimientos a petición.

MEGA-Speed-Drill-Steel

Broca helicoidal de metal duro

SCD621 (12xD), suministro de refrigerante interior, producto sucesor de la MEGA-Speed-Drill-Steel (SCD22)

Ejecución:

Diámetro de broca: 3,00 – 20,00 mm
 Tolerancia del agujero: \geq IT 9
 Material de corte: HP358
 Número de insertos: 2
 Número de biseles guía: 3
 Ángulo de la punta: 145°
 Ángulo de hélice: 30°

Aplicación:

Para el mecanizado de alta velocidad.

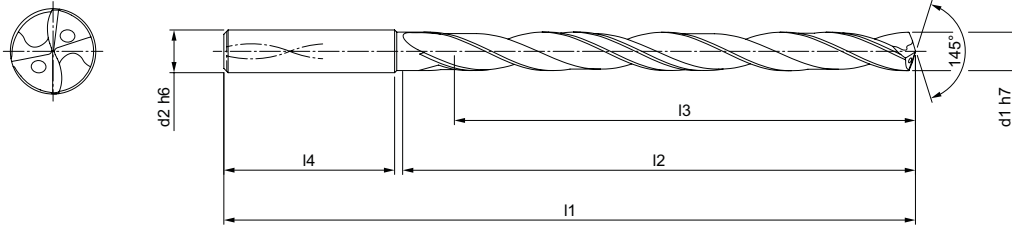

Serie preferente disponible en stock en forma de mango HA

Dimensiones						Forma del mango HA	
d ₁ h7	d ₂ h6	l ₁	l ₂	l ₃	l ₄	Especificación	Referencia
3,00	6	92	54	48	36	SCD621-0300-2-3-145HA12-HP358	31239148
3,20	6	92	54	48	36	SCD621-0320-2-3-145HA12-HP358	31239150
3,30	6	92	54	48	36	SCD621-0330-2-3-145HA12-HP358	31239151
3,40	6	92	54	48	36	SCD621-0340-2-3-145HA12-HP358	31239152
3,50	6	92	54	48	36	SCD621-0350-2-3-145HA12-HP358	31239153
3,70	6	92	54	48	36	SCD621-0370-2-3-145HA12-HP358	31239155
4,00	6	102	64	58	36	SCD621-0400-2-3-145HA12-HP358	31239158
4,10	6	102	64	58	36	SCD621-0410-2-3-145HA12-HP358	31239159
4,20	6	102	64	58	36	SCD621-0420-2-3-145HA12-HP358	31239160
4,30	6	102	64	58	36	SCD621-0430-2-3-145HA12-HP358	31239161
4,50	6	102	64	58	36	SCD621-0450-2-3-145HA12-HP358	31239163
4,80	6	116	78	70	36	SCD621-0480-2-3-145HA12-HP358	31239166
5,00	6	116	78	70	36	SCD621-0500-2-3-145HA12-HP358	31239168
5,10	6	116	78	70	36	SCD621-0510-2-3-145HA12-HP358	31239169
5,20	6	116	78	70	36	SCD621-0520-2-3-145HA12-HP358	31239170
5,40	6	116	78	70	36	SCD621-0540-2-3-145HA12-HP358	31239172
5,50	6	116	78	70	36	SCD621-0550-2-3-145HA12-HP358	31239173
5,80	6	116	78	70	36	SCD621-0580-2-3-145HA12-HP358	31239176
6,00	6	116	78	70	36	SCD621-0600-2-3-145HA12-HP358	31239178
6,10	8	146	108	94	36	SCD621-0610-2-3-145HA12-HP358	31239179
6,50	8	146	108	94	36	SCD621-0650-2-3-145HA12-HP358	31239183
6,80	8	146	108	94	36	SCD621-0680-2-3-145HA12-HP358	31239186
7,00	8	146	108	94	36	SCD621-0700-2-3-145HA12-HP358	31239188
7,50	8	146	108	94	36	SCD621-0750-2-3-145HA12-HP358	31239193
7,80	8	146	108	94	36	SCD621-0780-2-3-145HA12-HP358	31239196
8,00	8	146	108	94	36	SCD621-0800-2-3-145HA12-HP358	31239198
8,50	10	162	120	110	40	SCD621-0850-2-3-145HA12-HP358	31239203
9,00	10	162	120	110	40	SCD621-0900-2-3-145HA12-HP358	31239208
9,50	10	162	120	110	40	SCD621-0950-2-3-145HA12-HP358	31239213
9,80	10	162	120	110	40	SCD621-0980-2-3-145HA12-HP358	31239216
10,00	10	162	120	110	40	SCD621-1000-2-3-145HA12-HP358	31239218
10,20	12	204	156	142	45	SCD621-1020-2-3-145HA12-HP358	31239220
10,50	12	204	156	142	45	SCD621-1050-2-3-145HA12-HP358	31239223
11,00	12	204	156	142	45	SCD621-1100-2-3-145HA12-HP358	31239228
11,80	12	204	156	142	45	SCD621-1180-2-3-145HA12-HP358	31239236

Continúa en la página siguiente.

MEGA-Speed-Drill-Steel | Broca helicoidal de metal duro SCD621 (12xD), suministro de refrigerante interior

Dimensiones						Forma del mango HA	
d ₁ h7	d ₂ h6	l ₁	l ₂	l ₃	l ₄	Especificación	Referencia
12,00	12	204	156	142	45	SCD621-1200-2-3-145HA12-HP358	31239238
12,50	14	230	182	166	45	SCD621-1250-2-3-145HA12-HP358	31239240
13,00	14	230	182	166	45	SCD621-1300-2-3-145HA12-HP358	31239242
13,50	14	230	182	166	45	SCD621-1350-2-3-145HA12-HP358	31239243
14,00	14	230	182	166	45	SCD621-1400-2-3-145HA12-HP358	31239245
15,00	16	260	208	192	48	SCD621-1500-2-3-145HA12-HP358	31239248
16,00	16	260	208	192	48	SCD621-1600-2-3-145HA12-HP358	31239253

Características configurables

**Diámetro:**

Diámetro seleccionable libremente en incrementos de 0,01 mm

**Forma del mango:**

Forma del mango: HB | HE

Especificación

SCD621-[diámetro]-2-3-145[forma del mango]12-HP358

Ejemplo:

SCD621-0431-2-3-145HE12-HP358

Forma del mango HE

Diámetro de la herramienta d₁ = 4,31 mm

Dimensiones de la serie configurable

d ₁ min.	d ₁ max.	d ₂ h6	l ₁	l ₂	l ₃	l ₄
3,00	3,70	6	92	54	48	36
3,71	4,70	6	102	64	58	36
4,71	6,00	6	116	78	70	36
6,01	6,80	8	146	108	94	36
6,81	8,00	8	146	108	94	36
8,01	9,00	10	162	120	110	40
9,01	10,00	10	162	120	110	40
10,01	11,00	12	204	156	142	45
11,01	12,00	12	204	156	142	45
12,01	14,00	14	230	182	166	45
14,01	16,00	16	260	208	192	48
16,01	18,00	18	285	234	216	48
18,01	20,00	20	310	258	240	50

Medidas en mm.

Para la recomendación de valores de corte, véase al final del capítulo.

Ejecuciones especiales y otros recubrimientos a petición.

MEGA-180°-Drill

Broca helicoidal de metal duro

SCD231 (3xD), suministro de refrigerante interior

Ejecución:

Diámetro de broca:	3,00 – 20,00 mm
Tolerancia del agujero:	≥ IT 9
Material de corte:	HP230
Número de insertos:	2
Número de bisel guía:	4
Ángulo de la punta:	180°
Ángulo de hélice:	30°

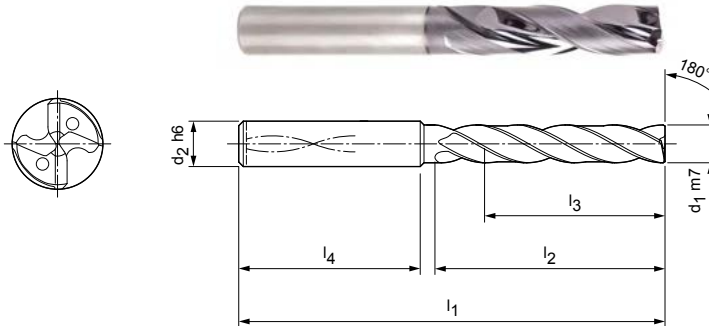

Serie preferente disponible en stock en forma de mango HA

Dimensiones						Forma del mango HA	
d ₁ m7	d ₂ h6	l ₁	l ₂	l ₃	l ₄	Especificación	Referencia
3,00	6	62	20	14	36	SCD231-0300-2-4-180HA03-HP230	30382647
3,10	6	62	20	14	36	SCD231-0310-2-4-180HA03-HP230	30382648
3,20	6	62	20	14	36	SCD231-0320-2-4-180HA03-HP230	30382649
3,30	6	62	20	14	36	SCD231-0330-2-4-180HA03-HP230	30382650
3,40	6	62	20	14	36	SCD231-0340-2-4-180HA03-HP230	30382651
3,50	6	62	20	14	36	SCD231-0350-2-4-180HA03-HP230	30382652
3,60	6	62	20	14	36	SCD231-0360-2-4-180HA03-HP230	30382653
3,70	6	62	20	14	36	SCD231-0370-2-4-180HA03-HP230	30382654
3,80	6	66	24	17	36	SCD231-0380-2-4-180HA03-HP230	30382655
3,90	6	66	24	17	36	SCD231-0390-2-4-180HA03-HP230	30382656
4,00	6	66	24	17	36	SCD231-0400-2-4-180HA03-HP230	30382657
4,10	6	66	24	17	36	SCD231-0410-2-4-180HA03-HP230	30382658
4,20	6	66	24	17	36	SCD231-0420-2-4-180HA03-HP230	30382659
4,30	6	66	24	17	36	SCD231-0430-2-4-180HA03-HP230	30382660
4,40	6	66	24	17	36	SCD231-0440-2-4-180HA03-HP230	30382661
4,50	6	66	24	17	36	SCD231-0450-2-4-180HA03-HP230	30382662
4,60	6	66	24	17	36	SCD231-0460-2-4-180HA03-HP230	30382663
4,65	6	66	24	17	36	SCD231-0465-2-4-180HA03-HP230	30382664
4,70	6	66	24	17	36	SCD231-0470-2-4-180HA03-HP230	30382665
4,80	6	66	28	20	36	SCD231-0480-2-4-180HA03-HP230	30382666
4,90	6	66	28	20	36	SCD231-0490-2-4-180HA03-HP230	30382667
5,00	6	66	28	20	36	SCD231-0500-2-4-180HA03-HP230	30382668
5,10	6	66	28	20	36	SCD231-0510-2-4-180HA03-HP230	30382669
5,20	6	66	28	20	36	SCD231-0520-2-4-180HA03-HP230	30382670
5,30	6	66	28	20	36	SCD231-0530-2-4-180HA03-HP230	30382671
5,40	6	66	28	20	36	SCD231-0540-2-4-180HA03-HP230	30382672
5,50	6	66	28	20	36	SCD231-0550-2-4-180HA03-HP230	30382673
5,55	6	66	28	20	36	SCD231-0555-2-4-180HA03-HP230	30382674
5,60	6	66	28	20	36	SCD231-0560-2-4-180HA03-HP230	30382675
5,70	6	66	28	20	36	SCD231-0570-2-4-180HA03-HP230	30382676
5,80	6	66	28	20	36	SCD231-0580-2-4-180HA03-HP230	30382677
5,90	6	66	28	20	36	SCD231-0590-2-4-180HA03-HP230	30382678
6,00	6	66	28	20	36	SCD231-0600-2-4-180HA03-HP230	30382679
6,10	8	79	34	24	36	SCD231-0610-2-4-180HA03-HP230	30382680
6,20	8	79	34	24	36	SCD231-0620-2-4-180HA03-HP230	30382681

Continúa en la página siguiente.

MEGA-180°-Drill | Broca helicoidal de metal duro SCD231 (3xD), suministro de refrigerante interior

Dimensiones						Forma del mango HA	
d ₁ m7	d ₂ h6	l ₁	l ₂	l ₃	l ₄	Especificación	Referencia
6,30	8	79	34	24	36	SCD231-0630-2-4-180HA03-HP230	30382682
6,40	8	79	34	24	36	SCD231-0640-2-4-180HA03-HP230	30382683
6,50	8	79	34	24	36	SCD231-0650-2-4-180HA03-HP230	30382684
6,60	8	79	34	24	36	SCD231-0660-2-4-180HA03-HP230	30382685
6,70	8	79	34	24	36	SCD231-0670-2-4-180HA03-HP230	30382686
6,80	8	79	34	24	36	SCD231-0680-2-4-180HA03-HP230	30382687
6,90	8	79	34	24	36	SCD231-0690-2-4-180HA03-HP230	30382688
7,00	8	79	34	24	36	SCD231-0700-2-4-180HA03-HP230	30382689
7,10	8	79	41	29	36	SCD231-0710-2-4-180HA03-HP230	30382690
7,20	8	79	41	29	36	SCD231-0720-2-4-180HA03-HP230	30382691
7,30	8	79	41	29	36	SCD231-0730-2-4-180HA03-HP230	30382692
7,40	8	79	41	29	36	SCD231-0740-2-4-180HA03-HP230	30382693
7,50	8	79	41	29	36	SCD231-0750-2-4-180HA03-HP230	30382694
7,60	8	79	41	29	36	SCD231-0760-2-4-180HA03-HP230	30382695
7,70	8	79	41	29	36	SCD231-0770-2-4-180HA03-HP230	30382696
7,80	8	79	41	29	36	SCD231-0780-2-4-180HA03-HP230	30382697
7,90	8	79	41	29	36	SCD231-0790-2-4-180HA03-HP230	30382698
8,00	8	79	41	29	36	SCD231-0800-2-4-180HA03-HP230	30382699
8,10	10	89	47	35	40	SCD231-0810-2-4-180HA03-HP230	30382700
8,20	10	89	47	35	40	SCD231-0820-2-4-180HA03-HP230	30382701
8,30	10	89	47	35	40	SCD231-0830-2-4-180HA03-HP230	30382702
8,40	10	89	47	35	40	SCD231-0840-2-4-180HA03-HP230	30382703
8,50	10	89	47	35	40	SCD231-0850-2-4-180HA03-HP230	30382704
8,60	10	89	47	35	40	SCD231-0860-2-4-180HA03-HP230	30382705
8,70	10	89	47	35	40	SCD231-0870-2-4-180HA03-HP230	30382706
8,80	10	89	47	35	40	SCD231-0880-2-4-180HA03-HP230	30382707
8,90	10	89	47	35	40	SCD231-0890-2-4-180HA03-HP230	30382708
9,00	10	89	47	35	40	SCD231-0900-2-4-180HA03-HP230	30382709
9,10	10	89	47	35	40	SCD231-0910-2-4-180HA03-HP230	30382710
9,20	10	89	47	35	40	SCD231-0920-2-4-180HA03-HP230	30382711
9,30	10	89	47	35	40	SCD231-0930-2-4-180HA03-HP230	30382712
9,40	10	89	47	35	40	SCD231-0940-2-4-180HA03-HP230	30382713
9,50	10	89	47	35	40	SCD231-0950-2-4-180HA03-HP230	30382714
9,60	10	89	47	35	40	SCD231-0960-2-4-180HA03-HP230	30382715
9,70	10	89	47	35	40	SCD231-0970-2-4-180HA03-HP230	30382716
9,80	10	89	47	35	40	SCD231-0980-2-4-180HA03-HP230	30382717
9,90	10	89	47	35	40	SCD231-0990-2-4-180HA03-HP230	30382718
10,00	10	89	47	35	40	SCD231-1000-2-4-180HA03-HP230	30382719
10,10	12	100	53	38	45	SCD231-1010-2-4-180HA03-HP230	30382720
10,20	12	100	53	38	45	SCD231-1020-2-4-180HA03-HP230	30382721
10,30	12	100	53	38	45	SCD231-1030-2-4-180HA03-HP230	30382722
10,40	12	100	53	38	45	SCD231-1040-2-4-180HA03-HP230	30382723
10,50	12	100	53	38	45	SCD231-1050-2-4-180HA03-HP230	30382724
10,60	12	100	53	38	45	SCD231-1060-2-4-180HA03-HP230	30382725
10,70	12	100	53	38	45	SCD231-1070-2-4-180HA03-HP230	30382726
10,80	12	100	53	38	45	SCD231-1080-2-4-180HA03-HP230	30382727
11,00	12	100	53	38	45	SCD231-1100-2-4-180HA03-HP230	30382729
11,10	12	100	53	38	45	SCD231-1110-2-4-180HA03-HP230	30382730
11,20	12	100	53	38	45	SCD231-1120-2-4-180HA03-HP230	30382731
11,30	12	100	53	38	45	SCD231-1130-2-4-180HA03-HP230	30382732
11,40	12	100	53	38	45	SCD231-1140-2-4-180HA03-HP230	30382733
11,50	12	100	53	38	45	SCD231-1150-2-4-180HA03-HP230	30382734
11,60	12	100	53	38	45	SCD231-1160-2-4-180HA03-HP230	30382735
11,70	12	100	53	38	45	SCD231-1170-2-4-180HA03-HP230	30382736
11,80	12	100	53	38	45	SCD231-1180-2-4-180HA03-HP230	30382737
11,90	12	100	53	38	45	SCD231-1190-2-4-180HA03-HP230	30382738
12,00	12	100	53	38	45	SCD231-1200-2-4-180HA03-HP230	30382739

MEGA-180°-Drill | Broca helicoidal de metal duro SCD231 (3xD), suministro de refrigerante interior

Dimensiones						Forma del mango HA	
d ₁ m7	d ₂ h6	l ₁	l ₂	l ₃	l ₄	Especificación	Referencia
12,50	14	105	58	41	45	SCD231-1250-2-4-180HA03-HP230	30382740
12,70	14	105	58	41	45	SCD231-1270-2-4-180HA03-HP230	30852019
12,80	14	105	58	41	45	SCD231-1280-2-4-180HA03-HP230	30382741
13,00	14	105	58	41	45	SCD231-1300-2-4-180HA03-HP230	30382742
13,50	14	105	58	41	45	SCD231-1350-2-4-180HA03-HP230	30382743
13,80	14	105	58	41	45	SCD231-1380-2-4-180HA03-HP230	30382744
14,00	14	105	58	41	45	SCD231-1400-2-4-180HA03-HP230	30382745
14,50	16	113	63	43	48	SCD231-1450-2-4-180HA03-HP230	30382746
14,80	16	113	63	43	48	SCD231-1480-2-4-180HA03-HP230	30382747
15,00	16	113	63	43	48	SCD231-1500-2-4-180HA03-HP230	30382748
15,50	16	113	63	43	48	SCD231-1550-2-4-180HA03-HP230	30382749
15,80	16	113	63	43	48	SCD231-1580-2-4-180HA03-HP230	30382750
16,00	16	113	63	43	48	SCD231-1600-2-4-180HA03-HP230	30382751
16,50	18	121	71	49	48	SCD231-1650-2-4-180HA03-HP230	30382752
16,80	18	121	71	49	48	SCD231-1680-2-4-180HA03-HP230	30382753
17,00	18	121	71	49	48	SCD231-1700-2-4-180HA03-HP230	30382754
17,50	18	121	71	49	48	SCD231-1750-2-4-180HA03-HP230	30382755
18,00	18	121	71	49	48	SCD231-1800-2-4-180HA03-HP230	30382757
18,50	20	129	77	53	50	SCD231-1850-2-4-180HA03-HP230	30382758
18,80	20	129	77	53	50	SCD231-1880-2-4-180HA03-HP230	30382759
19,00	20	129	77	53	50	SCD231-1900-2-4-180HA03-HP230	30382760
19,50	20	129	77	53	50	SCD231-1950-2-4-180HA03-HP230	30382761
20,00	20	129	77	53	50	SCD231-2000-2-4-180HA03-HP230	30382763

Características configurables

**Diámetro:**

Diámetro seleccionable libremente en incrementos de 0,01 mm

**Forma del mango:**

Forma del mango: HB | HE

Especificación

SCD231-[diámetro]-2-4-180[forma del mango]03-HP230

Ejemplo:

SCD231-0431-2-4-180HE03-HP230

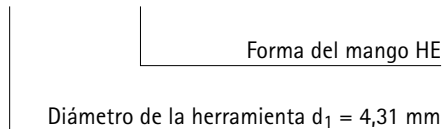

Dimensiones de la serie configurable

d ₁ min.	d ₁ max.	d ₂ h6	l ₁	l ₂	l ₃	l ₄
3,00	3,70	6	62	20	14	36
3,71	4,70	6	66	24	17	36
4,71	6,00	6	66	28	20	36
6,01	6,80	8	79	34	24	36
6,81	8,00	8	79	41	29	36
8,01	10,00	10	89	47	35	40
10,01	12,00	12	100	53	38	45
12,01	14,00	14	105	58	41	45
14,01	16,00	16	113	63	43	48
16,01	18,00	18	121	71	49	48
18,01	20,00	20	129	77	53	50

Medidas en mm.

Para la recomendación de valores de corte, véase al final del capítulo.

Ejecuciones especiales y otros recubrimientos a petición.

MEGA-180°-Drill

Broca helicoidal de metal duro

SCD231 (5xD), suministro de refrigerante interior

Ejecución:

Diámetro de broca: 3,00 – 20,00 mm

Tolerancia del agujero: \geq IT 9

Material de corte: HP230

Número de insertos: 2

Número de bisel guía: 4

Ángulo de la punta: 180°

Ángulo de hélice: 30°

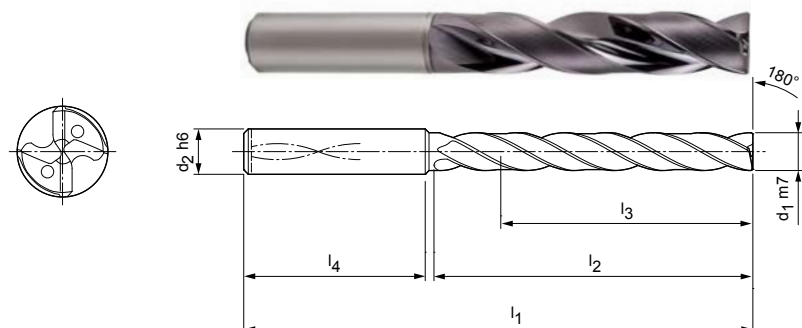

Serie preferente disponible en stock en forma de mango HA

Dimensiones						Forma del mango HA	
d ₁ m7	d ₂ h6	l ₁	l ₂	l ₃	l ₄	Especificación	Referencia
3,00	6	66	28	23	36	SCD231-0300-2-4-180HA05-HP230	30382764
3,10	6	66	28	23	36	SCD231-0310-2-4-180HA05-HP230	30382765
3,20	6	66	28	23	36	SCD231-0320-2-4-180HA05-HP230	30382766
3,30	6	66	28	23	36	SCD231-0330-2-4-180HA05-HP230	30382767
3,40	6	66	28	23	36	SCD231-0340-2-4-180HA05-HP230	30382768
3,50	6	66	28	23	36	SCD231-0350-2-4-180HA05-HP230	30382769
3,60	6	66	28	23	36	SCD231-0360-2-4-180HA05-HP230	30382770
3,70	6	66	28	23	36	SCD231-0370-2-4-180HA05-HP230	30382771
3,80	6	74	36	29	36	SCD231-0380-2-4-180HA05-HP230	30382772
3,90	6	74	36	29	36	SCD231-0390-2-4-180HA05-HP230	30382773
4,00	6	74	36	29	36	SCD231-0400-2-4-180HA05-HP230	30382774
4,10	6	74	36	29	36	SCD231-0410-2-4-180HA05-HP230	30382775
4,20	6	74	36	29	36	SCD231-0420-2-4-180HA05-HP230	30382776
4,30	6	74	36	29	36	SCD231-0430-2-4-180HA05-HP230	30382777
4,40	6	74	36	29	36	SCD231-0440-2-4-180HA05-HP230	30382778
4,50	6	74	36	29	36	SCD231-0450-2-4-180HA05-HP230	30382779
4,60	6	74	36	29	36	SCD231-0460-2-4-180HA05-HP230	30382780
4,80	6	82	44	35	36	SCD231-0480-2-4-180HA05-HP230	30382783
4,90	6	82	44	35	36	SCD231-0490-2-4-180HA05-HP230	30382784
5,00	6	82	44	35	36	SCD231-0500-2-4-180HA05-HP230	30382785
5,10	6	82	44	35	36	SCD231-0510-2-4-180HA05-HP230	30382786
5,20	6	82	44	35	36	SCD231-0520-2-4-180HA05-HP230	30382787
5,30	6	82	44	35	36	SCD231-0530-2-4-180HA05-HP230	30382788
5,40	6	82	44	35	36	SCD231-0540-2-4-180HA05-HP230	30382789
5,50	6	82	44	35	36	SCD231-0550-2-4-180HA05-HP230	30382790
5,55	6	82	44	35	36	SCD231-0555-2-4-180HA05-HP230	30382791
5,60	6	82	44	35	36	SCD231-0560-2-4-180HA05-HP230	30382792
5,70	6	82	44	35	36	SCD231-0570-2-4-180HA05-HP230	30382793
5,80	6	82	44	35	36	SCD231-0580-2-4-180HA05-HP230	30382794
5,90	6	82	44	35	36	SCD231-0590-2-4-180HA05-HP230	30382795
6,00	6	82	44	35	36	SCD231-0600-2-4-180HA05-HP230	30382796
6,10	8	91	53	43	36	SCD231-0610-2-4-180HA05-HP230	30382797
6,20	8	91	53	43	36	SCD231-0620-2-4-180HA05-HP230	30382798
6,30	8	91	53	43	36	SCD231-0630-2-4-180HA05-HP230	30382799
6,40	8	91	53	43	36	SCD231-0640-2-4-180HA05-HP230	30382800

MEGA-180°-Drill | Broca helicoidal de metal duro SCD231 (5xD), suministro de refrigerante interior

Dimensiones						Forma del mango HA	
d ₁ m7	d ₂ h6	l ₁	l ₂	l ₃	l ₄	Especificación	Referencia
6,50	8	91	53	43	36	SCD231-0650-2-4-180HA05-HP230	30382801
6,60	8	91	53	43	36	SCD231-0660-2-4-180HA05-HP230	30382802
6,70	8	91	53	43	36	SCD231-0670-2-4-180HA05-HP230	30382803
6,80	8	91	53	43	36	SCD231-0680-2-4-180HA05-HP230	30382804
6,90	8	91	53	43	36	SCD231-0690-2-4-180HA05-HP230	30382805
7,00	8	91	53	43	36	SCD231-0700-2-4-180HA05-HP230	30382806
7,10	8	91	53	43	36	SCD231-0710-2-4-180HA05-HP230	30382807
7,20	8	91	53	43	36	SCD231-0720-2-4-180HA05-HP230	30382808
7,30	8	91	53	43	36	SCD231-0730-2-4-180HA05-HP230	30382809
7,40	8	91	53	43	36	SCD231-0740-2-4-180HA05-HP230	30382810
7,50	8	91	53	43	36	SCD231-0750-2-4-180HA05-HP230	30382811
7,60	8	91	53	43	36	SCD231-0760-2-4-180HA05-HP230	30382812
7,80	8	91	53	43	36	SCD231-0780-2-4-180HA05-HP230	30382814
7,90	8	91	53	43	36	SCD231-0790-2-4-180HA05-HP230	30382815
8,00	8	91	53	43	36	SCD231-0800-2-4-180HA05-HP230	30382816
8,10	10	103	61	49	40	SCD231-0810-2-4-180HA05-HP230	30382817
8,20	10	103	61	49	40	SCD231-0820-2-4-180HA05-HP230	30382818
8,30	10	103	61	49	40	SCD231-0830-2-4-180HA05-HP230	30382819
8,40	10	103	61	49	40	SCD231-0840-2-4-180HA05-HP230	30382820
8,50	10	103	61	49	40	SCD231-0850-2-4-180HA05-HP230	30382821
8,60	10	103	61	49	40	SCD231-0860-2-4-180HA05-HP230	30382822
8,70	10	103	61	49	40	SCD231-0870-2-4-180HA05-HP230	30382823
8,80	10	103	61	49	40	SCD231-0880-2-4-180HA05-HP230	30382824
8,90	10	103	61	49	40	SCD231-0890-2-4-180HA05-HP230	30382825
9,00	10	103	61	49	40	SCD231-0900-2-4-180HA05-HP230	30382826
9,10	10	103	61	49	40	SCD231-0910-2-4-180HA05-HP230	30382827
9,20	10	103	61	49	40	SCD231-0920-2-4-180HA05-HP230	30382828
9,30	10	103	61	49	40	SCD231-0930-2-4-180HA05-HP230	30382829
9,40	10	103	61	49	40	SCD231-0940-2-4-180HA05-HP230	30382830
9,50	10	103	61	49	40	SCD231-0950-2-4-180HA05-HP230	30382831
9,60	10	103	61	49	40	SCD231-0960-2-4-180HA05-HP230	30382832
9,70	10	103	61	49	40	SCD231-0970-2-4-180HA05-HP230	30382833
9,80	10	103	61	49	40	SCD231-0980-2-4-180HA05-HP230	30382834
9,90	10	103	61	49	40	SCD231-0990-2-4-180HA05-HP230	30382835
10,00	10	103	61	49	40	SCD231-1000-2-4-180HA05-HP230	30382836
10,10	12	116	69	54	45	SCD231-1010-2-4-180HA05-HP230	30382838
10,20	12	116	69	54	45	SCD231-1020-2-4-180HA05-HP230	30382840
10,30	12	116	69	54	45	SCD231-1030-2-4-180HA05-HP230	30382841
10,40	12	116	69	54	45	SCD231-1040-2-4-180HA05-HP230	30382842
10,50	12	116	69	54	45	SCD231-1050-2-4-180HA05-HP230	30382843
10,60	12	116	69	54	45	SCD231-1060-2-4-180HA05-HP230	30382844
10,65	12	116	69	54	45	SCD231-1065-2-4-180HA05-HP230	31198519
10,80	12	116	69	54	45	SCD231-1080-2-4-180HA05-HP230	30382846
11,00	12	116	69	54	45	SCD231-1100-2-4-180HA05-HP230	30382848
11,20	12	116	69	54	45	SCD231-1120-2-4-180HA05-HP230	30382850
11,50	12	116	69	54	45	SCD231-1150-2-4-180HA05-HP230	30382853
11,60	12	116	69	54	45	SCD231-1160-2-4-180HA05-HP230	30382854
11,70	12	116	69	54	45	SCD231-1170-2-4-180HA05-HP230	30382855
11,80	12	116	69	54	45	SCD231-1180-2-4-180HA05-HP230	30382856
12,00	12	116	69	54	45	SCD231-1200-2-4-180HA05-HP230	30382858
12,50	14	122	75	58	45	SCD231-1250-2-4-180HA05-HP230	30382859
12,80	14	122	75	58	45	SCD231-1280-2-4-180HA05-HP230	30382860
13,00	14	122	75	58	45	SCD231-1300-2-4-180HA05-HP230	30382861
13,50	14	122	75	58	45	SCD231-1350-2-4-180HA05-HP230	30382862
13,80	14	122	75	58	45	SCD231-1380-2-4-180HA05-HP230	30382863
14,00	14	122	75	58	45	SCD231-1400-2-4-180HA05-HP230	30382864
14,50	16	131	81	61	48	SCD231-1450-2-4-180HA05-HP230	30382865

Continúa en la página siguiente.

MEGA-180°-Drill | Broca helicoidal de metal duro SCD231 (5xD), suministro de refrigerante interior

Dimensiones						Forma del mango HA	
d ₁ m7	d ₂ h6	l ₁	l ₂	l ₃	l ₄	Especificación	Referencia
14,80	16	131	81	61	48	SCD231-1480-2-4-180HA05-HP230	30382866
15,00	16	131	81	61	48	SCD231-1500-2-4-180HA05-HP230	30382867
15,50	16	131	81	61	48	SCD231-1550-2-4-180HA05-HP230	30382868
15,80	16	131	81	61	48	SCD231-1580-2-4-180HA05-HP230	30382869
16,00	16	131	81	61	48	SCD231-1600-2-4-180HA05-HP230	30382870
16,50	18	141	91	69	48	SCD231-1650-2-4-180HA05-HP230	30382871
17,00	18	141	91	69	48	SCD231-1700-2-4-180HA05-HP230	30382873
17,50	18	141	91	69	48	SCD231-1750-2-4-180HA05-HP230	30382874
17,80	18	141	91	69	48	SCD231-1780-2-4-180HA05-HP230	30382875
18,00	18	141	91	69	48	SCD231-1800-2-4-180HA05-HP230	30382876
18,50	20	151	99	75	50	SCD231-1850-2-4-180HA05-HP230	30382877
19,00	20	151	99	75	50	SCD231-1900-2-4-180HA05-HP230	30382879
19,80	20	151	99	75	50	SCD231-1980-2-4-180HA05-HP230	30382881
20,00	20	151	99	75	50	SCD231-2000-2-4-180HA05-HP230	30382882

Características configurables

**Diámetro:**

Diámetro seleccionable libremente en incrementos de 0,01 mm

**Forma del mango:**

Forma del mango: HB | HE

Especificación

SCD231-[diámetro]-2-4-180[forma del mango]05-HP230

Dimensiones de la serie configurable

d ₁ min.	d ₁ max.	d ₂ h6	l ₁	l ₂	l ₃	l ₄
3,00	3,70	6	66	28	23	36
3,71	4,70	6	74	36	29	36
4,71	6,00	6	82	44	35	36
6,01	8,00	8	91	53	43	36
8,01	10,00	10	103	61	49	40
10,01	12,00	12	116	69	54	45
12,01	14,00	14	122	75	58	45
14,01	16,00	16	131	81	61	48
16,01	18,00	18	141	91	69	48
18,01	20,00	20	151	99	75	50

Ejemplo:

SCD231-0431-2-4-180HE05-HP230

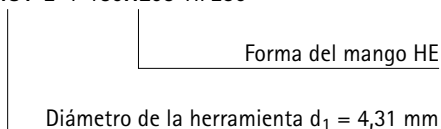

Medidas en mm.

Para la recomendación de valores de corte, véase al final del capítulo.

Ejecuciones especiales y otros recubrimientos a petición.

ECU-Drill-Steel

Broca helicoidal de metal duro

SCD361 (3xD), suministro de refrigerante interior

Ejecución:

Diámetro de broca: 3,00 - 20,00 mm

Tolerancia del agujero: \geq IT 9

Material de corte: HP132

Número de insertos: 2

Ángulo de la punta: 140°

Ángulo de hélice: 30°

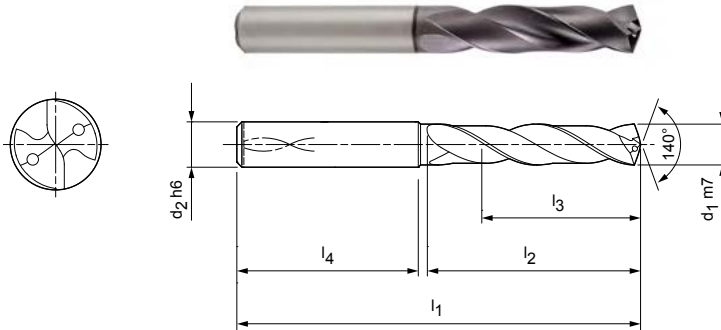

Serie preferente disponible en stock en forma de mango HA

Dimensiones						Forma del mango HA	
d ₁ m7	d ₂ h6	l ₁	l ₂	l ₃	l ₄	Especificación	Referencia
3,00	6	62	20	14	36	SCD361-0300-2-2-140HA03-HP132	30421364
3,10	6	62	20	14	36	SCD361-0310-2-2-140HA03-HP132	30421365
3,20	6	62	20	14	36	SCD361-0320-2-2-140HA03-HP132	30421366
3,30	6	62	20	14	36	SCD361-0330-2-2-140HA03-HP132	30421368
3,40	6	62	20	14	36	SCD361-0340-2-2-140HA03-HP132	30421369
3,50	6	62	20	14	36	SCD361-0350-2-2-140HA03-HP132	30421370
3,70*	6	62	20	14	36	SCD361-0370-2-2-140HA03-HP132	30421372
3,80	6	66	24	17	36	SCD361-0380-2-2-140HA03-HP132	30421373
3,90	6	66	24	17	36	SCD361-0390-2-2-140HA03-HP132	30421374
4,00	6	66	24	17	36	SCD361-0400-2-2-140HA03-HP132	30421375
4,10	6	66	24	17	36	SCD361-0410-2-2-140HA03-HP132	30421376
4,20	6	66	24	17	36	SCD361-0420-2-2-140HA03-HP132	30421377
4,30	6	66	24	17	36	SCD361-0430-2-2-140HA03-HP132	30421379
4,40	6	66	24	17	36	SCD361-0440-2-2-140HA03-HP132	30421380
4,50	6	66	24	17	36	SCD361-0450-2-2-140HA03-HP132	30421381
4,60	6	66	24	17	36	SCD361-0460-2-2-140HA03-HP132	30421382
4,65*	6	66	24	17	36	SCD361-0465-2-2-140HA03-HP132	30421383
4,70	6	66	24	17	36	SCD361-0470-2-2-140HA03-HP132	30421384
4,80	6	66	28	20	36	SCD361-0480-2-2-140HA03-HP132	30421385
4,90	6	66	28	20	36	SCD361-0490-2-2-140HA03-HP132	30421386
5,00	6	66	28	20	36	SCD361-0500-2-2-140HA03-HP132	30421388
5,10	6	66	28	20	36	SCD361-0510-2-2-140HA03-HP132	30421390
5,20	6	66	28	20	36	SCD361-0520-2-2-140HA03-HP132	30421391
5,30	6	66	28	20	36	SCD361-0530-2-2-140HA03-HP132	30421392
5,40	6	66	28	20	36	SCD361-0540-2-2-140HA03-HP132	30421393
5,50	6	66	28	20	36	SCD361-0550-2-2-140HA03-HP132	30421394
5,55*	6	66	28	20	36	SCD361-0555-2-2-140HA03-HP132	30421395
5,60	6	66	28	20	36	SCD361-0560-2-2-140HA03-HP132	30421396
5,80	6	66	28	20	36	SCD361-0580-2-2-140HA03-HP132	30421399
5,90	6	66	28	20	36	SCD361-0590-2-2-140HA03-HP132	30421400
6,00	6	66	28	20	36	SCD361-0600-2-2-140HA03-HP132	30421401
6,10	8	79	34	24	36	SCD361-0610-2-2-140HA03-HP132	30421402
6,20	8	79	34	24	36	SCD361-0620-2-2-140HA03-HP132	30421403
6,30	8	79	34	24	36	SCD361-0630-2-2-140HA03-HP132	30421404
6,40	8	79	34	24	36	SCD361-0640-2-2-140HA03-HP132	30421405

Continúa en la página siguiente.

ECU-Drill-Steel | Broca helicoidal de metal duro SCD361 (3xD), suministro de refrigerante interior

Dimensiones						Forma del mango HA	
d ₁ m7	d ₂ h6	l ₁	l ₂	l ₃	l ₄	Especificación	Referencia
6,50	8	79	34	24	36	SCD361-0650-2-2-140HA03-HP132	30421406
6,60	8	79	34	24	36	SCD361-0660-2-2-140HA03-HP132	30421407
6,70	8	79	34	24	36	SCD361-0670-2-2-140HA03-HP132	30421408
6,80	8	79	34	24	36	SCD361-0680-2-2-140HA03-HP132	30421409
6,90	8	79	34	24	36	SCD361-0690-2-2-140HA03-HP132	30421410
7,00	8	79	34	24	36	SCD361-0700-2-2-140HA03-HP132	30421411
7,10	8	79	41	29	36	SCD361-0710-2-2-140HA03-HP132	30421412
7,20	8	79	41	29	36	SCD361-0720-2-2-140HA03-HP132	30421413
7,40	8	79	41	29	36	SCD361-0740-2-2-140HA03-HP132	30421415
7,45*	8	79	41	29	36	SCD361-0745-2-2-140HA03-HP132	30421416
7,50	8	79	41	29	36	SCD361-0750-2-2-140HA03-HP132	30421417
7,70	8	79	41	29	36	SCD361-0770-2-2-140HA03-HP132	30421420
7,80	8	79	41	29	36	SCD361-0780-2-2-140HA03-HP132	30421421
7,90	8	79	41	29	36	SCD361-0790-2-2-140HA03-HP132	30421422
8,00	8	79	41	29	36	SCD361-0800-2-2-140HA03-HP132	30421423
8,10	10	89	47	35	40	SCD361-0810-2-2-140HA03-HP132	30421424
8,20	10	89	47	35	40	SCD361-0820-2-2-140HA03-HP132	30421425
8,30	10	89	47	35	40	SCD361-0830-2-2-140HA03-HP132	30421426
8,40	10	89	47	35	40	SCD361-0840-2-2-140HA03-HP132	30421427
8,50	10	89	47	35	40	SCD361-0850-2-2-140HA03-HP132	30421428
8,60	10	89	47	35	40	SCD361-0860-2-2-140HA03-HP132	30421429
8,70	10	89	47	35	40	SCD361-0870-2-2-140HA03-HP132	30421430
8,80	10	89	47	35	40	SCD361-0880-2-2-140HA03-HP132	30421431
8,90	10	89	47	35	40	SCD361-0890-2-2-140HA03-HP132	30421432
9,00	10	89	47	35	40	SCD361-0900-2-2-140HA03-HP132	30421433
9,10	10	89	47	35	40	SCD361-0910-2-2-140HA03-HP132	30421434
9,20	10	89	47	35	40	SCD361-0920-2-2-140HA03-HP132	30421435
9,30*	10	89	47	35	40	SCD361-0930-2-2-140HA03-HP132	30421437
9,35	10	89	47	35	40	SCD361-0935-2-2-140HA03-HP132	30421438
9,40	10	89	47	35	40	SCD361-0940-2-2-140HA03-HP132	30421439
9,50	10	89	47	35	40	SCD361-0950-2-2-140HA03-HP132	30421440
9,60	10	89	47	35	40	SCD361-0960-2-2-140HA03-HP132	30421441
9,80	10	89	47	35	40	SCD361-0980-2-2-140HA03-HP132	30421443
9,90	10	89	47	35	40	SCD361-0990-2-2-140HA03-HP132	30421445
10,00	10	89	47	35	40	SCD361-1000-2-2-140HA03-HP132	30421446
10,10	12	102	55	40	45	SCD361-1010-2-2-140HA03-HP132	30421447
10,20	12	102	55	40	45	SCD361-1020-2-2-140HA03-HP132	30421448
10,30	12	102	55	40	45	SCD361-1030-2-2-140HA03-HP132	30421449
10,40	12	102	55	40	45	SCD361-1040-2-2-140HA03-HP132	30421450
10,50	12	102	55	40	45	SCD361-1050-2-2-140HA03-HP132	30421451
10,60	12	102	55	40	45	SCD361-1060-2-2-140HA03-HP132	30421453
10,70	12	102	55	40	45	SCD361-1070-2-2-140HA03-HP132	30421454
10,80	12	102	55	40	45	SCD361-1080-2-2-140HA03-HP132	30421456
10,90	12	102	55	40	45	SCD361-1090-2-2-140HA03-HP132	30421457
11,00	12	102	55	40	45	SCD361-1100-2-2-140HA03-HP132	30421458
11,10	12	102	55	40	45	SCD361-1110-2-2-140HA03-HP132	30421459
11,20*	12	102	55	40	45	SCD361-1120-2-2-140HA03-HP132	30421460
11,40	12	102	55	40	45	SCD361-1140-2-2-140HA03-HP132	30421463
11,50	12	102	55	40	45	SCD361-1150-2-2-140HA03-HP132	30421464
11,70	12	102	55	40	45	SCD361-1170-2-2-140HA03-HP132	30421466
11,80	12	102	55	40	45	SCD361-1180-2-2-140HA03-HP132	30421467
12,00	12	102	55	40	45	SCD361-1200-2-2-140HA03-HP132	30421469
12,25	14	107	60	43	45	SCD361-1225-2-2-140HA03-HP132	30421470
12,50	14	107	60	43	45	SCD361-1250-2-2-140HA03-HP132	30421471
12,70	14	107	60	43	45	SCD361-1270-2-2-140HA03-HP132	30421472
12,80	14	107	60	43	45	SCD361-1280-2-2-140HA03-HP132	30421473
12,90	14	107	60	43	45	SCD361-1290-2-2-140HA03-HP132	30421474

ECU-Drill-Steel | Broca helicoidal de metal duro SCD361 (3xD), suministro de refrigerante interior

Dimensiones						Forma del mango HA	
d ₁ m7	d ₂ h6	l ₁	l ₂	l ₃	l ₄	Especificación	Referencia
13,00	14	107	60	43	45	SCD361-1300-2-2-140HA03-HP132	30421475
13,10	14	107	60	43	45	SCD361-1310-2-2-140HA03-HP132	30421476
13,20	14	107	60	43	45	SCD361-1320-2-2-140HA03-HP132	30421477
13,50	14	107	60	43	45	SCD361-1350-2-2-140HA03-HP132	30421479
13,80	14	107	60	43	45	SCD361-1380-2-2-140HA03-HP132	30421481
14,00	14	107	60	43	45	SCD361-1400-2-2-140HA03-HP132	30421482
14,20	16	115	65	45	48	SCD361-1420-2-2-140HA03-HP132	30421483
14,50	16	115	65	45	48	SCD361-1450-2-2-140HA03-HP132	30421484
14,80	16	115	65	45	48	SCD361-1480-2-2-140HA03-HP132	30421487
15,00	16	115	65	45	48	SCD361-1500-2-2-140HA03-HP132	30421488
15,10	16	115	65	45	48	SCD361-1510-2-2-140HA03-HP132	30421489
15,25	16	115	65	45	48	SCD361-1525-2-2-140HA03-HP132	30421490
15,30	16	115	65	45	48	SCD361-1530-2-2-140HA03-HP132	30421491
15,50	16	115	65	45	48	SCD361-1550-2-2-140HA03-HP132	30421493
15,80	16	115	65	45	48	SCD361-1580-2-2-140HA03-HP132	30421496
16,00	16	115	65	45	48	SCD361-1600-2-2-140HA03-HP132	30421497
16,50	18	123	73	51	48	SCD361-1650-2-2-140HA03-HP132	30421498
16,80	18	123	73	51	48	SCD361-1680-2-2-140HA03-HP132	30421499
17,00	18	123	73	51	48	SCD361-1700-2-2-140HA03-HP132	30421501
17,50	18	123	73	51	48	SCD361-1750-2-2-140HA03-HP132	30421502
17,80	18	123	73	51	48	SCD361-1780-2-2-140HA03-HP132	30421504
18,00	18	123	73	51	48	SCD361-1800-2-2-140HA03-HP132	30421505
18,50	20	131	79	55	50	SCD361-1850-2-2-140HA03-HP132	30421506
19,00	20	131	79	55	50	SCD361-1900-2-2-140HA03-HP132	30421509
19,80	20	131	79	55	50	SCD361-1980-2-2-140HA03-HP132	30421512
20,00	20	131	79	55	50	SCD361-2000-2-2-140HA03-HP132	30421513

Características configurables



Forma del mango:
Forma del mango: HB | HE



Especificación
SCD361-0430-2-2-140[forma del mango]03-HP132

Ejemplo:
SCD361-0430-2-2-140HE03-HP132

Forma del mango HE

Medidas en mm.

* Especialmente indicada para la prefabricación de los agujeros para rosca para machos de laminación.

Para la recomendación de valores de corte, véase al final del capítulo.

Ejecuciones especiales y otros recubrimientos a petición.

ECU-Drill-Steel

Broca helicoidal de metal duro

SCD360 (3xD), suministro de refrigerante exterior

Ejecución:

Diámetro de broca: 3,00 - 20,00 mm

Tolerancia del agujero: \geq IT 9

Material de corte: HP132

Número de insertos: 2

Ángulo de la punta: 140°

Ángulo de hélice: 30°

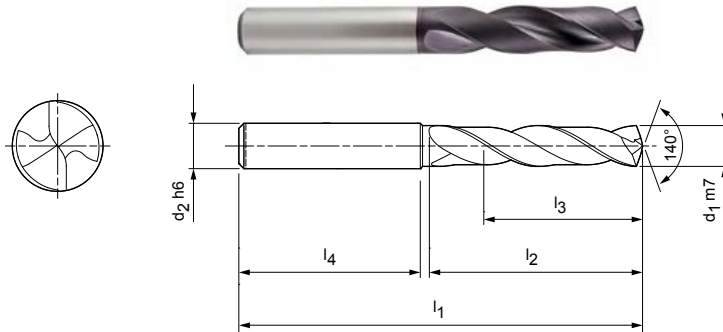

Serie preferente disponible en stock en forma de mango HA

Dimensiones						Forma del mango HA	
d ₁ m7	d ₂ h6	l ₁	l ₂	l ₃	l ₄	Especificación	Referencia
3,00	6	62	20	14	36	SCD360-0300-2-2-140HA03-HP132	30421215
3,10	6	62	20	14	36	SCD360-0310-2-2-140HA03-HP132	30421216
3,20	6	62	20	14	36	SCD360-0320-2-2-140HA03-HP132	30421217
3,30	6	62	20	14	36	SCD360-0330-2-2-140HA03-HP132	30421218
3,40	6	62	20	14	36	SCD360-0340-2-2-140HA03-HP132	30421219
3,50	6	62	20	14	36	SCD360-0350-2-2-140HA03-HP132	30421220
3,60	6	62	20	14	36	SCD360-0360-2-2-140HA03-HP132	30421221
3,70*	6	62	20	14	36	SCD360-0370-2-2-140HA03-HP132	30421222
3,80	6	66	24	17	36	SCD360-0380-2-2-140HA03-HP132	30421223
3,90	6	66	24	17	36	SCD360-0390-2-2-140HA03-HP132	30421224
4,00	6	66	24	17	36	SCD360-0400-2-2-140HA03-HP132	30421225
4,02	6	66	24	17	36	SCD360-0402-2-2-140HA03-HP132	30421226
4,10	6	66	24	17	36	SCD360-0410-2-2-140HA03-HP132	30421227
4,20	6	66	24	17	36	SCD360-0420-2-2-140HA03-HP132	30421228
4,30	6	66	24	17	36	SCD360-0430-2-2-140HA03-HP132	30421229
4,40	6	66	24	17	36	SCD360-0440-2-2-140HA03-HP132	30421230
4,50	6	66	24	17	36	SCD360-0450-2-2-140HA03-HP132	30421231
4,60	6	66	24	17	36	SCD360-0460-2-2-140HA03-HP132	30421232
4,65*	6	66	24	17	36	SCD360-0465-2-2-140HA03-HP132	30421233
4,70	6	66	24	17	36	SCD360-0470-2-2-140HA03-HP132	30421234
4,80	6	66	28	20	36	SCD360-0480-2-2-140HA03-HP132	30421235
4,90	6	66	28	20	36	SCD360-0490-2-2-140HA03-HP132	30421236
5,00	6	66	28	20	36	SCD360-0500-2-2-140HA03-HP132	30421237
5,10	6	66	28	20	36	SCD360-0510-2-2-140HA03-HP132	30421238
5,20	6	66	28	20	36	SCD360-0520-2-2-140HA03-HP132	30421240
5,30	6	66	28	20	36	SCD360-0530-2-2-140HA03-HP132	30421241
5,40	6	66	28	20	36	SCD360-0540-2-2-140HA03-HP132	30421242
5,50	6	66	28	20	36	SCD360-0550-2-2-140HA03-HP132	30421243
5,55*	6	66	28	20	36	SCD360-0555-2-2-140HA03-HP132	30421244
5,60	6	66	28	20	36	SCD360-0560-2-2-140HA03-HP132	30421245
5,70	6	66	28	20	36	SCD360-0570-2-2-140HA03-HP132	30421246
5,80	6	66	28	20	36	SCD360-0580-2-2-140HA03-HP132	30421247
5,90	6	66	28	20	36	SCD360-0590-2-2-140HA03-HP132	30421248
6,00	6	66	28	20	36	SCD360-0600-2-2-140HA03-HP132	30421249
6,10	8	79	34	24	36	SCD360-0610-2-2-140HA03-HP132	30421250

ECU-Drill-Steel | Broca helicoidal de metal duro SCD360 (3xD), suministro de refrigerante exterior

Dimensiones						Forma del mango HA	
d ₁ m7	d ₂ h6	l ₁	l ₂	l ₃	l ₄	Especificación	Referencia
6,20	8	79	34	24	36	SCD360-0620-2-2-140HA03-HP132	30421251
6,30	8	79	34	24	36	SCD360-0630-2-2-140HA03-HP132	30421252
6,40	8	79	34	24	36	SCD360-0640-2-2-140HA03-HP132	30421253
6,50	8	79	34	24	36	SCD360-0650-2-2-140HA03-HP132	30421254
6,60	8	79	34	24	36	SCD360-0660-2-2-140HA03-HP132	30421255
6,70	8	79	34	24	36	SCD360-0670-2-2-140HA03-HP132	30421256
6,80	8	79	34	24	36	SCD360-0680-2-2-140HA03-HP132	30421257
6,90	8	79	34	24	36	SCD360-0690-2-2-140HA03-HP132	30421258
7,00	8	79	34	24	36	SCD360-0700-2-2-140HA03-HP132	30421259
7,10	8	79	41	29	36	SCD360-0710-2-2-140HA03-HP132	30421260
7,20	8	79	41	29	36	SCD360-0720-2-2-140HA03-HP132	30421261
7,30	8	79	41	29	36	SCD360-0730-2-2-140HA03-HP132	30421262
7,40	8	79	41	29	36	SCD360-0740-2-2-140HA03-HP132	30421263
7,50	8	79	41	29	36	SCD360-0750-2-2-140HA03-HP132	30421264
7,60	8	79	41	29	36	SCD360-0760-2-2-140HA03-HP132	30421266
7,70	8	79	41	29	36	SCD360-0770-2-2-140HA03-HP132	30421267
7,80	8	79	41	29	36	SCD360-0780-2-2-140HA03-HP132	30421268
7,90	8	79	41	29	36	SCD360-0790-2-2-140HA03-HP132	30421269
8,00	8	79	41	29	36	SCD360-0800-2-2-140HA03-HP132	30421270
8,10	10	89	47	35	40	SCD360-0810-2-2-140HA03-HP132	30421271
8,20	10	89	47	35	40	SCD360-0820-2-2-140HA03-HP132	30421272
8,30	10	89	47	35	40	SCD360-0830-2-2-140HA03-HP132	30421273
8,40	10	89	47	35	40	SCD360-0840-2-2-140HA03-HP132	30421274
8,50	10	89	47	35	40	SCD360-0850-2-2-140HA03-HP132	30421275
8,60	10	89	47	35	40	SCD360-0860-2-2-140HA03-HP132	30421276
8,70	10	89	47	35	40	SCD360-0870-2-2-140HA03-HP132	30421277
8,80	10	89	47	35	40	SCD360-0880-2-2-140HA03-HP132	30421278
8,90	10	89	47	35	40	SCD360-0890-2-2-140HA03-HP132	30421279
9,00	10	89	47	35	40	SCD360-0900-2-2-140HA03-HP132	30421280
9,10	10	89	47	35	40	SCD360-0910-2-2-140HA03-HP132	30421281
9,20	10	89	47	35	40	SCD360-0920-2-2-140HA03-HP132	30421282
9,30*	10	89	47	35	40	SCD360-0930-2-2-140HA03-HP132	30421284
9,40	10	89	47	35	40	SCD360-0940-2-2-140HA03-HP132	30421285
9,50	10	89	47	35	40	SCD360-0950-2-2-140HA03-HP132	30421286
9,60	10	89	47	35	40	SCD360-0960-2-2-140HA03-HP132	30421287
9,70	10	89	47	35	40	SCD360-0970-2-2-140HA03-HP132	30421288
9,80	10	89	47	35	40	SCD360-0980-2-2-140HA03-HP132	30421289
9,90	10	89	47	35	40	SCD360-0990-2-2-140HA03-HP132	30421290
10,00	10	89	47	35	40	SCD360-1000-2-2-140HA03-HP132	30421291
10,10	12	102	55	40	45	SCD360-1010-2-2-140HA03-HP132	30421292
10,20	12	102	55	40	45	SCD360-1020-2-2-140HA03-HP132	30421293
10,30	12	102	55	40	45	SCD360-1030-2-2-140HA03-HP132	30421294
10,40	12	102	55	40	45	SCD360-1040-2-2-140HA03-HP132	30421295
10,50	12	102	55	40	45	SCD360-1050-2-2-140HA03-HP132	30421296
10,60	12	102	55	40	45	SCD360-1060-2-2-140HA03-HP132	30421297
10,70	12	102	55	40	45	SCD360-1070-2-2-140HA03-HP132	30421298
10,80	12	102	55	40	45	SCD360-1080-2-2-140HA03-HP132	30421300
10,90	12	102	55	40	45	SCD360-1090-2-2-140HA03-HP132	30421301
11,00	12	102	55	40	45	SCD360-1100-2-2-140HA03-HP132	30421302
11,10	12	102	55	40	45	SCD360-1110-2-2-140HA03-HP132	30421303
11,20*	12	102	55	40	45	SCD360-1120-2-2-140HA03-HP132	30421304
11,30	12	102	55	40	45	SCD360-1130-2-2-140HA03-HP132	30421305
11,40	12	102	55	40	45	SCD360-1140-2-2-140HA03-HP132	30421306
11,50	12	102	55	40	45	SCD360-1150-2-2-140HA03-HP132	30421307
11,60	12	102	55	40	45	SCD360-1160-2-2-140HA03-HP132	30421308
11,70	12	102	55	40	45	SCD360-1170-2-2-140HA03-HP132	30421309
11,80	12	102	55	40	45	SCD360-1180-2-2-140HA03-HP132	30421310

Continúa en la página siguiente.

ECU-Drill-Steel | Broca helicoidal de metal duro SCD360 (3xD), suministro de refrigerante exterior

Dimensiones						Forma del mango HA	
d ₁ m7	d ₂ h6	l ₁	l ₂	l ₃	l ₄	Especificación	Referencia
11,90	12	102	55	40	45	SCD360-1190-2-2-140HA03-HP132	30421312
12,00	12	102	55	40	45	SCD360-1200-2-2-140HA03-HP132	30421313
12,20	14	107	60	43	45	SCD360-1220-2-2-140HA03-HP132	30569112
12,25	14	107	60	43	45	SCD360-1225-2-2-140HA03-HP132	30421314
12,50	14	107	60	43	45	SCD360-1250-2-2-140HA03-HP132	30421316
12,70	14	107	60	43	45	SCD360-1270-2-2-140HA03-HP132	30421317
12,80	14	107	60	43	45	SCD360-1280-2-2-140HA03-HP132	30421318
13,00	14	107	60	43	45	SCD360-1300-2-2-140HA03-HP132	30421320
13,30	14	107	60	43	45	SCD360-1330-2-2-140HA03-HP132	30421323
13,50	14	107	60	43	45	SCD360-1350-2-2-140HA03-HP132	30421324
13,70	14	107	60	43	45	SCD360-1370-2-2-140HA03-HP132	30421325
13,80	14	107	60	43	45	SCD360-1380-2-2-140HA03-HP132	30421326
14,00	14	107	60	43	45	SCD360-1400-2-2-140HA03-HP132	30421327
14,20	16	115	65	45	48	SCD360-1420-2-2-140HA03-HP132	30421328
14,50	16	115	65	45	48	SCD360-1450-2-2-140HA03-HP132	30421330
14,70	16	115	65	45	48	SCD360-1470-2-2-140HA03-HP132	30421331
15,00	16	115	65	45	48	SCD360-1500-2-2-140HA03-HP132	30421333
15,25	16	115	65	45	48	SCD360-1525-2-2-140HA03-HP132	30421335
15,30	16	115	65	45	48	SCD360-1530-2-2-140HA03-HP132	30421336
15,50	16	115	65	45	48	SCD360-1550-2-2-140HA03-HP132	30421337
15,80	16	115	65	45	48	SCD360-1580-2-2-140HA03-HP132	30421339
16,00	16	115	65	45	48	SCD360-1600-2-2-140HA03-HP132	30421340
16,50	18	123	73	51	48	SCD360-1650-2-2-140HA03-HP132	30421341
16,80	18	123	73	51	48	SCD360-1680-2-2-140HA03-HP132	30421342
17,00	18	123	73	51	48	SCD360-1700-2-2-140HA03-HP132	30421343
17,50	18	123	73	51	48	SCD360-1750-2-2-140HA03-HP132	30421344
17,80	18	123	73	51	48	SCD360-1780-2-2-140HA03-HP132	30421345
18,00	18	123	73	51	48	SCD360-1800-2-2-140HA03-HP132	30421346
18,50	20	131	79	55	50	SCD360-1850-2-2-140HA03-HP132	30421347
19,00	20	131	79	55	50	SCD360-1900-2-2-140HA03-HP132	30421349
19,50	20	131	79	55	50	SCD360-1950-2-2-140HA03-HP132	30421350
19,80	20	131	79	55	50	SCD360-1980-2-2-140HA03-HP132	30421351
20,00	20	131	79	55	50	SCD360-2000-2-2-140HA03-HP132	30421352

Características configurables



Forma del mango:
Forma del mango: HB | HE

Especificación
SCD360-0430-2-2-140[forma del mango]05-HP132

Ejemplo:
SCD360-0430-2-2-140HE05-HP132

Forma del mango HE

Medidas en mm.

* Especialmente indicada para la prefabricación de los agujeros para rosca para machos de laminación.

Para la recomendación de valores de corte, véase el final del capítulo.

Ejecuciones especiales y otros recubrimientos a petición.

ECU-Drill-Steel

Broca helicoidal de metal duro

SCD361 (5xD), suministro de refrigerante interior

Ejecución:

Diámetro de broca: 3,00 - 20,00 mm

Tolerancia del agujero: \geq IT 9

Material de corte: HP132

Número de insertos: 2

Ángulo de la punta: 140°

Ángulo de hélice: 30°

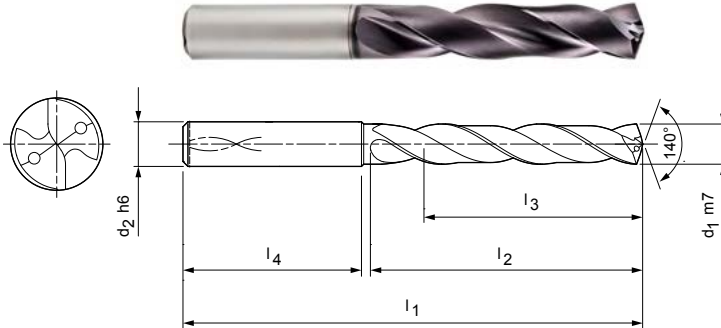

Serie preferente disponible en stock en forma de mango HA

Dimensiones						Forma del mango HA	
d ₁ m7	d ₂ h6	l ₁	l ₂	l ₃	l ₄	Especificación	Referencia
3,00	6	66	28	23	36	SCD361-0300-2-2-140HA05-HP132	30421524
3,10	6	66	28	23	36	SCD361-0310-2-2-140HA05-HP132	30421525
3,20	6	66	28	23	36	SCD361-0320-2-2-140HA05-HP132	30421526
3,30	6	66	28	23	36	SCD361-0330-2-2-140HA05-HP132	30421528
3,40	6	66	28	23	36	SCD361-0340-2-2-140HA05-HP132	30421529
3,50	6	66	28	23	36	SCD361-0350-2-2-140HA05-HP132	30421530
3,60	6	66	28	23	36	SCD361-0360-2-2-140HA05-HP132	30421531
3,70*	6	66	28	23	36	SCD361-0370-2-2-140HA05-HP132	30421532
3,80	6	74	36	29	36	SCD361-0380-2-2-140HA05-HP132	30421533
3,90	6	74	36	29	36	SCD361-0390-2-2-140HA05-HP132	30421534
4,00	6	74	36	29	36	SCD361-0400-2-2-140HA05-HP132	30421535
4,10	6	74	36	29	36	SCD361-0410-2-2-140HA05-HP132	30421536
4,20	6	74	36	29	36	SCD361-0420-2-2-140HA05-HP132	30421537
4,30	6	74	36	29	36	SCD361-0430-2-2-140HA05-HP132	30421539
4,40	6	74	36	29	36	SCD361-0440-2-2-140HA05-HP132	30421540
4,50	6	74	36	29	36	SCD361-0450-2-2-140HA05-HP132	30421541
4,60	6	74	36	29	36	SCD361-0460-2-2-140HA05-HP132	30421542
4,65*	6	74	36	29	36	SCD361-0465-2-2-140HA05-HP132	30421543
4,70	6	74	36	29	36	SCD361-0470-2-2-140HA05-HP132	30421544
4,80	6	82	44	35	36	SCD361-0480-2-2-140HA05-HP132	30421545
4,90	6	82	44	35	36	SCD361-0490-2-2-140HA05-HP132	30421546
5,00	6	82	44	35	36	SCD361-0500-2-2-140HA05-HP132	30421548
5,10	6	82	44	35	36	SCD361-0510-2-2-140HA05-HP132	30421550
5,20	6	82	44	35	36	SCD361-0520-2-2-140HA05-HP132	30421551
5,30	6	82	44	35	36	SCD361-0530-2-2-140HA05-HP132	30421552
5,40	6	82	44	35	36	SCD361-0540-2-2-140HA05-HP132	30421553
5,50	6	82	44	35	36	SCD361-0550-2-2-140HA05-HP132	30421554
5,55*	6	82	44	35	36	SCD361-0555-2-2-140HA05-HP132	30421555
5,60	6	82	44	35	36	SCD361-0560-2-2-140HA05-HP132	30421556
5,70	6	82	44	35	36	SCD361-0570-2-2-140HA05-HP132	30421557
5,80	6	82	44	35	36	SCD361-0580-2-2-140HA05-HP132	30421559
5,90	6	82	44	35	36	SCD361-0590-2-2-140HA05-HP132	30421560
6,00	6	82	44	35	36	SCD361-0600-2-2-140HA05-HP132	30421561
6,10	8	91	53	43	36	SCD361-0610-2-2-140HA05-HP132	30421562
6,20	8	91	53	43	36	SCD361-0620-2-2-140HA05-HP132	30421563

Continúa en la página siguiente.

ECU-Drill-Steel | Broca helicoidal de metal duro SCD361 (5xD), suministro de refrigerante interior

Dimensiones						Forma del mango HA	
d ₁ m7	d ₂ h6	l ₁	l ₂	l ₃	l ₄	Especificación	Referencia
6,30	8	91	53	43	36	SCD361-0630-2-2-140HA05-HP132	30421564
6,40	8	91	53	43	36	SCD361-0640-2-2-140HA05-HP132	30421565
6,50	8	91	53	43	36	SCD361-0650-2-2-140HA05-HP132	30421566
6,60	8	91	53	43	36	SCD361-0660-2-2-140HA05-HP132	30421567
6,70	8	91	53	43	36	SCD361-0670-2-2-140HA05-HP132	30421568
6,80	8	91	53	43	36	SCD361-0680-2-2-140HA05-HP132	30421569
6,90	8	91	53	43	36	SCD361-0690-2-2-140HA05-HP132	30421570
7,00	8	91	53	43	36	SCD361-0700-2-2-140HA05-HP132	30421571
7,10	8	91	53	43	36	SCD361-0710-2-2-140HA05-HP132	30421572
7,20	8	91	53	43	36	SCD361-0720-2-2-140HA05-HP132	30421573
7,30	8	91	53	43	36	SCD361-0730-2-2-140HA05-HP132	30421574
7,40	8	91	53	43	36	SCD361-0740-2-2-140HA05-HP132	30421575
7,45*	8	91	53	43	36	SCD361-0745-2-2-140HA05-HP132	30421576
7,50	8	91	53	43	36	SCD361-0750-2-2-140HA05-HP132	30421577
7,60	8	91	53	43	36	SCD361-0760-2-2-140HA05-HP132	30421579
7,70	8	91	53	43	36	SCD361-0770-2-2-140HA05-HP132	30421580
7,80	8	91	53	43	36	SCD361-0780-2-2-140HA05-HP132	30421581
7,90	8	91	53	43	36	SCD361-0790-2-2-140HA05-HP132	30421582
8,00	8	91	53	43	36	SCD361-0800-2-2-140HA05-HP132	30421583
8,10	10	103	61	49	40	SCD361-0810-2-2-140HA05-HP132	30421584
8,20	10	103	61	49	40	SCD361-0820-2-2-140HA05-HP132	30421585
8,30	10	103	61	49	40	SCD361-0830-2-2-140HA05-HP132	30421586
8,40	10	103	61	49	40	SCD361-0840-2-2-140HA05-HP132	30421587
8,50	10	103	61	49	40	SCD361-0850-2-2-140HA05-HP132	30421588
8,60	10	103	61	49	40	SCD361-0860-2-2-140HA05-HP132	30421589
8,70	10	103	61	49	40	SCD361-0870-2-2-140HA05-HP132	30421590
8,80	10	103	61	49	40	SCD361-0880-2-2-140HA05-HP132	30421591
8,90	10	103	61	49	40	SCD361-0890-2-2-140HA05-HP132	30421592
9,00	10	103	61	49	40	SCD361-0900-2-2-140HA05-HP132	30421593
9,10	10	103	61	49	40	SCD361-0910-2-2-140HA05-HP132	30421594
9,20	10	103	61	49	40	SCD361-0920-2-2-140HA05-HP132	30421595
9,30*	10	103	61	49	40	SCD361-0930-2-2-140HA05-HP132	30421597
9,35	10	103	61	49	40	SCD361-0935-2-2-140HA05-HP132	30421598
9,40	10	103	61	49	40	SCD361-0940-2-2-140HA05-HP132	30421599
9,50	10	103	61	49	40	SCD361-0950-2-2-140HA05-HP132	30421600
9,60	10	103	61	49	40	SCD361-0960-2-2-140HA05-HP132	30421601
9,70	10	103	61	49	40	SCD361-0970-2-2-140HA05-HP132	30421602
9,80	10	103	61	49	40	SCD361-0980-2-2-140HA05-HP132	30421603
9,90	10	103	61	49	40	SCD361-0990-2-2-140HA05-HP132	30421604
10,00	10	103	61	49	40	SCD361-1000-2-2-140HA05-HP132	30421605
10,10	12	118	71	56	45	SCD361-1010-2-2-140HA05-HP132	30421606
10,20	12	118	71	56	45	SCD361-1020-2-2-140HA05-HP132	30421607
10,30	12	118	71	56	45	SCD361-1030-2-2-140HA05-HP132	30421608
10,40	12	118	71	56	45	SCD361-1040-2-2-140HA05-HP132	30421609
10,50	12	118	71	56	45	SCD361-1050-2-2-140HA05-HP132	30421610
10,60	12	118	71	56	45	SCD361-1060-2-2-140HA05-HP132	30421612
10,70	12	118	71	56	45	SCD361-1070-2-2-140HA05-HP132	30421613
10,80	12	118	71	56	45	SCD361-1080-2-2-140HA05-HP132	30421615
10,90	12	118	71	56	45	SCD361-1090-2-2-140HA05-HP132	30421616
11,00	12	118	71	56	45	SCD361-1100-2-2-140HA05-HP132	30421617
11,10	12	118	71	56	45	SCD361-1110-2-2-140HA05-HP132	30421618
11,20*	12	118	71	56	45	SCD361-1120-2-2-140HA05-HP132	30421619
11,25	12	118	71	56	45	SCD361-1125-2-2-140HA05-HP132	30421620
11,30	12	118	71	56	45	SCD361-1130-2-2-140HA05-HP132	30421621
11,40	12	118	71	56	45	SCD361-1140-2-2-140HA05-HP132	30421622
11,50	12	118	71	56	45	SCD361-1150-2-2-140HA05-HP132	30421623
11,60	12	118	71	56	45	SCD361-1160-2-2-140HA05-HP132	30421624

ECU-Drill-Steel | Broca helicoidal de metal duro SCD361 (5xD), suministro de refrigerante interior

Dimensiones						Forma del mango HA	
d ₁ m7	d ₂ h6	l ₁	l ₂	l ₃	l ₄	Especificación	Referencia
11,70	12	118	71	56	45	SCD361-1170-2-2-140HA05-HP132	30421625
11,80	12	118	71	56	45	SCD361-1180-2-2-140HA05-HP132	30421626
11,90	12	118	71	56	45	SCD361-1190-2-2-140HA05-HP132	30421628
12,00	12	118	71	56	45	SCD361-1200-2-2-140HA05-HP132	30421629
12,20	14	124	77	60	45	SCD361-1220-2-2-140HA05-HP132	30569175
12,25	14	124	77	60	45	SCD361-1225-2-2-140HA05-HP132	30421630
12,50	14	124	77	60	45	SCD361-1250-2-2-140HA05-HP132	30421632
12,70	14	124	77	60	45	SCD361-1270-2-2-140HA05-HP132	30421633
12,80	14	124	77	60	45	SCD361-1280-2-2-140HA05-HP132	30421634
12,90	14	124	77	60	45	SCD361-1290-2-2-140HA05-HP132	30421635
13,00	14	124	77	60	45	SCD361-1300-2-2-140HA05-HP132	30421636
13,10	14	124	77	60	45	SCD361-1310-2-2-140HA05-HP132	30421637
13,20	14	124	77	60	45	SCD361-1320-2-2-140HA05-HP132	30421638
13,50	14	124	77	60	45	SCD361-1350-2-2-140HA05-HP132	30421640
13,70	14	124	77	60	45	SCD361-1370-2-2-140HA05-HP132	30421641
13,80	14	124	77	60	45	SCD361-1380-2-2-140HA05-HP132	30421642
14,00	14	124	77	60	45	SCD361-1400-2-2-140HA05-HP132	30421643
14,20	16	133	83	63	48	SCD361-1420-2-2-140HA05-HP132	30421644
14,50	16	133	83	63	48	SCD361-1450-2-2-140HA05-HP132	30421645
14,70	16	133	83	63	48	SCD361-1470-2-2-140HA05-HP132	30421646
14,80	16	133	83	63	48	SCD361-1480-2-2-140HA05-HP132	30421647
15,00	16	133	83	63	48	SCD361-1500-2-2-140HA05-HP132	30421648
15,10	16	133	83	63	48	SCD361-1510-2-2-140HA05-HP132	30421649
15,25	16	133	83	63	48	SCD361-1525-2-2-140HA05-HP132	30421650
15,30	16	133	83	63	48	SCD361-1530-2-2-140HA05-HP132	30421651
15,50	16	133	83	63	48	SCD361-1550-2-2-140HA05-HP132	30421652
15,70	16	133	83	63	48	SCD361-1570-2-2-140HA05-HP132	30421654
15,80	16	133	83	63	48	SCD361-1580-2-2-140HA05-HP132	30421655
16,00	16	133	83	63	48	SCD361-1600-2-2-140HA05-HP132	30421656
16,50	18	143	93	71	48	SCD361-1650-2-2-140HA05-HP132	30421657
16,80	18	143	93	71	48	SCD361-1680-2-2-140HA05-HP132	30421658
17,00	18	143	93	71	48	SCD361-1700-2-2-140HA05-HP132	30421660
17,50	18	143	93	71	48	SCD361-1750-2-2-140HA05-HP132	30421661
17,80	18	143	93	71	48	SCD361-1780-2-2-140HA05-HP132	30421663
18,00	18	143	93	71	48	SCD361-1800-2-2-140HA05-HP132	30421664
18,50	20	153	101	77	50	SCD361-1850-2-2-140HA05-HP132	30421665
18,80	20	153	101	77	50	SCD361-1880-2-2-140HA05-HP132	30421666
19,00	20	153	101	77	50	SCD361-1900-2-2-140HA05-HP132	30421668
19,50	20	153	101	77	50	SCD361-1950-2-2-140HA05-HP132	30421669
19,80	20	153	101	77	50	SCD361-1980-2-2-140HA05-HP132	30421671
20,00	20	153	101	77	50	SCD361-2000-2-2-140HA05-HP132	30421672

Continúa en la página siguiente.

ECU-Drill-Steel | Broca helicoidal de metal duro SCD361 (5xD), suministro de refrigerante interior

Características configurables



Forma del mango:
Forma del mango: HB | HE

**Especificación**

SCD361-0430-2-2-140[forma del mango]05-HP132

Ejemplo:

SCD361-0430-2-2-140HE05-HP132

Forma del mango HE

Medidas en mm.

* Especialmente indicada para la prefabricación de los agujeros para rosca para machos de laminación.

Para la recomendación de valores de corte, véase al final del capítulo.

Ejecuciones especiales y otros recubrimientos a petición.

ECU-Drill-Steel

Broca helicoidal de metal duro

SCD360 (5xD), suministro de refrigerante exterior

Ejecución:

Diámetro de broca: 3,00 - 20,00 mm

Tolerancia del agujero: \geq IT 9

Material de corte: HP132

Número de insertos: 2

Ángulo de la punta: 140°

Ángulo de hélice: 30°

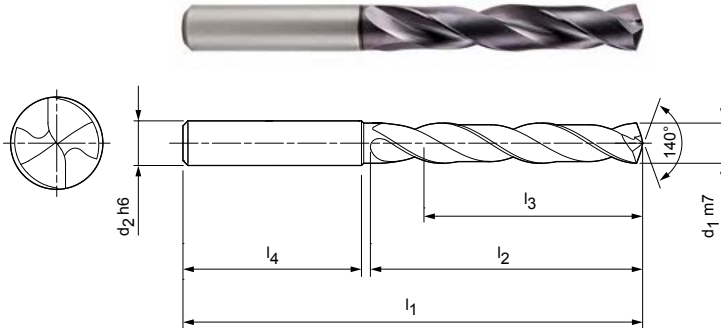

Serie preferente disponible en stock en forma de mango HA

Dimensiones						Forma del mango HA	
d ₁ m7	d ₂ h6	l ₁	l ₂	l ₃	l ₄	Especificación	Referencia
3,00	6	66	28	23	36	SCD360-0300-2-2-140HA05-HP132	30568692
3,10	6	66	28	23	36	SCD360-0310-2-2-140HA05-HP132	30568693
3,20	6	66	28	23	36	SCD360-0320-2-2-140HA05-HP132	30568694
3,30	6	66	28	23	36	SCD360-0330-2-2-140HA05-HP132	30568695
3,40	6	66	28	23	36	SCD360-0340-2-2-140HA05-HP132	30568696
3,50	6	66	28	23	36	SCD360-0350-2-2-140HA05-HP132	30568697
3,60	6	66	28	23	36	SCD360-0360-2-2-140HA05-HP132	30568698
3,70*	6	66	28	23	36	SCD360-0370-2-2-140HA05-HP132	30568699
3,80	6	74	36	29	36	SCD360-0380-2-2-140HA05-HP132	30568700
3,90	6	74	36	29	36	SCD360-0390-2-2-140HA05-HP132	30568701
4,00	6	74	36	29	36	SCD360-0400-2-2-140HA05-HP132	30568702
4,10	6	74	36	29	36	SCD360-0410-2-2-140HA05-HP132	30568703
4,20	6	74	36	29	36	SCD360-0420-2-2-140HA05-HP132	30568704
4,30	6	74	36	29	36	SCD360-0430-2-2-140HA05-HP132	30568705
4,40	6	74	36	29	36	SCD360-0440-2-2-140HA05-HP132	30568706
4,50	6	74	36	29	36	SCD360-0450-2-2-140HA05-HP132	30568707
4,60	6	74	36	29	36	SCD360-0460-2-2-140HA05-HP132	30568708
4,65*	6	74	36	29	36	SCD360-0465-2-2-140HA05-HP132	30568709
4,70	6	74	36	29	36	SCD360-0470-2-2-140HA05-HP132	30568710
4,80	6	82	44	35	36	SCD360-0480-2-2-140HA05-HP132	30568711
4,90	6	82	44	35	36	SCD360-0490-2-2-140HA05-HP132	30568712
5,00	6	82	44	35	36	SCD360-0500-2-2-140HA05-HP132	30568713
5,10	6	82	44	35	36	SCD360-0510-2-2-140HA05-HP132	30568714
5,20	6	82	44	35	36	SCD360-0520-2-2-140HA05-HP132	30568715
5,30	6	82	44	35	36	SCD360-0530-2-2-140HA05-HP132	30568716
5,40	6	82	44	35	36	SCD360-0540-2-2-140HA05-HP132	30568717
5,50	6	82	44	35	36	SCD360-0550-2-2-140HA05-HP132	30568718
5,55*	6	82	44	35	36	SCD360-0555-2-2-140HA05-HP132	30568719
5,60	6	82	44	35	36	SCD360-0560-2-2-140HA05-HP132	30568720
5,70	6	82	44	35	36	SCD360-0570-2-2-140HA05-HP132	30568721
5,80	6	82	44	35	36	SCD360-0580-2-2-140HA05-HP132	30568722
5,90	6	82	44	35	36	SCD360-0590-2-2-140HA05-HP132	30568723
6,00	6	82	44	35	36	SCD360-0600-2-2-140HA05-HP132	30568724
6,10	8	91	53	43	36	SCD360-0610-2-2-140HA05-HP132	30568725
6,20	8	91	53	43	36	SCD360-0620-2-2-140HA05-HP132	30568726

Continúa en la página siguiente.

ECU-Drill-Steel | Broca helicoidal de metal duro SCD360 (5xD), suministro de refrigerante exterior

Dimensiones						Forma del mango HA	
d ₁ m7	d ₂ h6	l ₁	l ₂	l ₃	l ₄	Especificación	Referencia
6,30	8	91	53	43	36	SCD360-0630-2-2-140HA05-HP132	30568727
6,40	8	91	53	43	36	SCD360-0640-2-2-140HA05-HP132	30568728
6,50	8	91	53	43	36	SCD360-0650-2-2-140HA05-HP132	30568729
6,60	8	91	53	43	36	SCD360-0660-2-2-140HA05-HP132	30568730
6,70	8	91	53	43	36	SCD360-0670-2-2-140HA05-HP132	30568731
6,80	8	91	53	43	36	SCD360-0680-2-2-140HA05-HP132	30568732
6,90	8	91	53	43	36	SCD360-0690-2-2-140HA05-HP132	30568733
7,00	8	91	53	43	36	SCD360-0700-2-2-140HA05-HP132	30568734
7,10	8	91	53	43	36	SCD360-0710-2-2-140HA05-HP132	30568735
7,20	8	91	53	43	36	SCD360-0720-2-2-140HA05-HP132	30568736
7,30	8	91	53	43	36	SCD360-0730-2-2-140HA05-HP132	30568737
7,40	8	91	53	43	36	SCD360-0740-2-2-140HA05-HP132	30568738
7,50	8	91	53	43	36	SCD360-0750-2-2-140HA05-HP132	30568740
7,60	8	91	53	43	36	SCD360-0760-2-2-140HA05-HP132	30568741
7,70	8	91	53	43	36	SCD360-0770-2-2-140HA05-HP132	30568742
7,80	8	91	53	43	36	SCD360-0780-2-2-140HA05-HP132	30568743
7,90	8	91	53	43	36	SCD360-0790-2-2-140HA05-HP132	30568744
8,00	8	91	53	43	36	SCD360-0800-2-2-140HA05-HP132	30568745
8,10	10	103	61	49	40	SCD360-0810-2-2-140HA05-HP132	30568746
8,20	10	103	61	49	40	SCD360-0820-2-2-140HA05-HP132	30568747
8,30	10	103	61	49	40	SCD360-0830-2-2-140HA05-HP132	30568748
8,40	10	103	61	49	40	SCD360-0840-2-2-140HA05-HP132	30568749
8,50	10	103	61	49	40	SCD360-0850-2-2-140HA05-HP132	30568750
8,60	10	103	61	49	40	SCD360-0860-2-2-140HA05-HP132	30568751
8,70	10	103	61	49	40	SCD360-0870-2-2-140HA05-HP132	30568752
8,80	10	103	61	49	40	SCD360-0880-2-2-140HA05-HP132	30568753
8,90	10	103	61	49	40	SCD360-0890-2-2-140HA05-HP132	30568754
9,00	10	103	61	49	40	SCD360-0900-2-2-140HA05-HP132	30568755
9,10	10	103	61	49	40	SCD360-0910-2-2-140HA05-HP132	30568756
9,20	10	103	61	49	40	SCD360-0920-2-2-140HA05-HP132	30568757
9,30*	10	103	61	49	40	SCD360-0930-2-2-140HA05-HP132	30568758
9,40	10	103	61	49	40	SCD360-0940-2-2-140HA05-HP132	30568759
9,50	10	103	61	49	40	SCD360-0950-2-2-140HA05-HP132	30568760
9,60	10	103	61	49	40	SCD360-0960-2-2-140HA05-HP132	30568761
9,70	10	103	61	49	40	SCD360-0970-2-2-140HA05-HP132	30568762
9,80	10	103	61	49	40	SCD360-0980-2-2-140HA05-HP132	30568763
9,90	10	103	61	49	40	SCD360-0990-2-2-140HA05-HP132	30568764
10,00	10	103	61	49	40	SCD360-1000-2-2-140HA05-HP132	30568765
10,10	12	118	71	56	45	SCD360-1010-2-2-140HA05-HP132	30568766
10,20	12	118	71	56	45	SCD360-1020-2-2-140HA05-HP132	30568767
10,30	12	118	71	56	45	SCD360-1030-2-2-140HA05-HP132	30568768
10,40	12	118	71	56	45	SCD360-1040-2-2-140HA05-HP132	30568769
10,50	12	118	71	56	45	SCD360-1050-2-2-140HA05-HP132	30568770
10,60	12	118	71	56	45	SCD360-1060-2-2-140HA05-HP132	30568771
10,80	12	118	71	56	45	SCD360-1080-2-2-140HA05-HP132	30568773
11,00	12	118	71	56	45	SCD360-1100-2-2-140HA05-HP132	30568775
11,10	12	118	71	56	45	SCD360-1110-2-2-140HA05-HP132	30568776
11,20*	12	118	71	56	45	SCD360-1120-2-2-140HA05-HP132	30568777
11,30	12	118	71	56	45	SCD360-1130-2-2-140HA05-HP132	30568778
11,40	12	118	71	56	45	SCD360-1140-2-2-140HA05-HP132	30568779
11,50	12	118	71	56	45	SCD360-1150-2-2-140HA05-HP132	30568780
11,60	12	118	71	56	45	SCD360-1160-2-2-140HA05-HP132	30568781
11,70	12	118	71	56	45	SCD360-1170-2-2-140HA05-HP132	30568782
11,80	12	118	71	56	45	SCD360-1180-2-2-140HA05-HP132	30568783
11,90	12	118	71	56	45	SCD360-1190-2-2-140HA05-HP132	30568784
12,00	12	118	71	56	45	SCD360-1200-2-2-140HA05-HP132	30568785
12,20	14	124	77	60	45	SCD360-1220-2-2-140HA05-HP132	30568786

ECU-Drill-Steel | Broca helicoidal de metal duro SCD360 (5xD), suministro de refrigerante exterior

Dimensiones						Forma del mango HA	
d ₁ m7	d ₂ h6	l ₁	l ₂	l ₃	l ₄	Especificación	Referencia
12,50	14	124	77	60	45	SCD360-1250-2-2-140HA05-HP132	30568787
12,70	14	124	77	60	45	SCD360-1270-2-2-140HA05-HP132	30568788
12,80	14	124	77	60	45	SCD360-1280-2-2-140HA05-HP132	30568789
13,00	14	124	77	60	45	SCD360-1300-2-2-140HA05-HP132	30568790
13,10	14	124	77	60	45	SCD360-1310-2-2-140HA05-HP132	30569190
13,50	14	124	77	60	45	SCD360-1350-2-2-140HA05-HP132	30568792
13,70	14	124	77	60	45	SCD360-1370-2-2-140HA05-HP132	30568793
13,80	14	124	77	60	45	SCD360-1380-2-2-140HA05-HP132	30568794
14,00	14	124	77	60	45	SCD360-1400-2-2-140HA05-HP132	30568795
14,20	16	133	83	63	48	SCD360-1420-2-2-140HA05-HP132	30568796
14,50	16	133	83	63	48	SCD360-1450-2-2-140HA05-HP132	30568797
14,70	16	133	83	63	48	SCD360-1470-2-2-140HA05-HP132	30568798
14,80	16	133	83	63	48	SCD360-1480-2-2-140HA05-HP132	30568799
15,00	16	133	83	63	48	SCD360-1500-2-2-140HA05-HP132	30568800
15,50	16	133	83	63	48	SCD360-1550-2-2-140HA05-HP132	30568801
15,70	16	133	83	63	48	SCD360-1570-2-2-140HA05-HP132	30568802
15,80	16	133	83	63	48	SCD360-1580-2-2-140HA05-HP132	30568803
16,00	16	133	83	63	48	SCD360-1600-2-2-140HA05-HP132	30568804
16,50	18	143	93	71	48	SCD360-1650-2-2-140HA05-HP132	30568805
17,00	18	143	93	71	48	SCD360-1700-2-2-140HA05-HP132	30568807
17,50	18	143	93	71	48	SCD360-1750-2-2-140HA05-HP132	30568808
18,00	18	143	93	71	48	SCD360-1800-2-2-140HA05-HP132	30568810
18,50	20	153	101	77	50	SCD360-1850-2-2-140HA05-HP132	30568811
18,80	20	153	101	77	50	SCD360-1880-2-2-140HA05-HP132	30568812
19,00	20	153	101	77	50	SCD360-1900-2-2-140HA05-HP132	30568813
19,80	20	153	101	77	50	SCD360-1980-2-2-140HA05-HP132	30568815
20,00	20	153	101	77	50	SCD360-2000-2-2-140HA05-HP132	30568816

Características configurables



Forma del mango:
Forma del mango: HB | HE



Especificación

SCD360-0430-2-2-140[forma del mango]05-HP132

Ejemplo:
SCD360-0430-2-2-140HE05-HP132

Forma del mango HE

Medidas en mm.

* Especialmente indicada para la prefabricación de los agujeros para rosca para machos de laminación.

Para la recomendación de valores de corte, véase al final del capítulo.

Ejecuciones especiales y otros recubrimientos a petición.

ECU-Drill-Steel

Broca helicoidal de metal duro
SCD361 (8xD), suministro de refrigerante interior

Ejecución:
 Diámetro de broca: 3,00 - 20,00 mm
 Tolerancia del agujero: ≥ IT 9
 Material de corte: HP132
 Número de insertos: 2
 Ángulo de la punta: 135°
 Ángulo de hélice: 30°

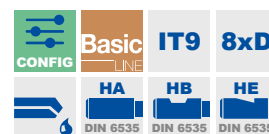
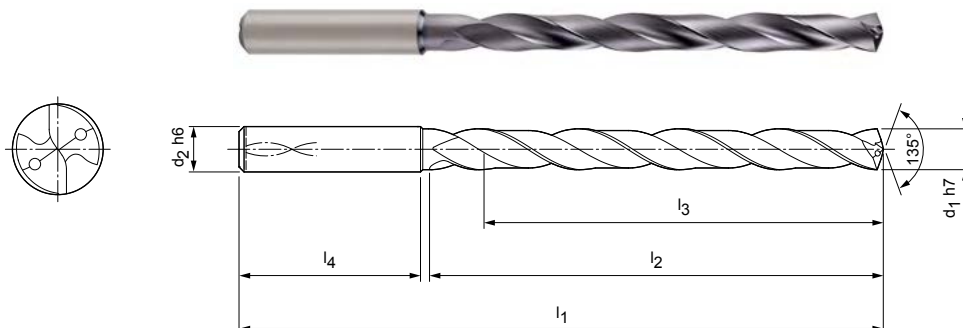

Serie preferente disponible en stock en forma de mango HA

Dimensiones						Forma del mango HA	
d ₁ h7	d ₂ h6	l ₁	l ₂	l ₃	l ₄	Especificación	Referencia
3,00	6	72	34	29	36	SCD361-0300-2-2-135HA08-HP132	30677713
3,10	6	72	34	29	36	SCD361-0310-2-2-135HA08-HP132	30677714
3,20	6	72	34	29	36	SCD361-0320-2-2-135HA08-HP132	30677715
3,30	6	72	34	29	36	SCD361-0330-2-2-135HA08-HP132	30677716
3,40	6	72	34	29	36	SCD361-0340-2-2-135HA08-HP132	30677717
3,50	6	72	34	29	36	SCD361-0350-2-2-135HA08-HP132	30677718
3,60	6	72	34	29	36	SCD361-0360-2-2-135HA08-HP132	30677719
3,70	6	72	34	29	36	SCD361-0370-2-2-135HA08-HP132	30677720
3,80	6	81	43	36	36	SCD361-0380-2-2-135HA08-HP132	30677721
3,90	6	81	43	36	36	SCD361-0390-2-2-135HA08-HP132	30677722
4,00	6	81	43	36	36	SCD361-0400-2-2-135HA08-HP132	30677723
4,10	6	81	43	36	36	SCD361-0410-2-2-135HA08-HP132	30677724
4,20	6	81	43	36	36	SCD361-0420-2-2-135HA08-HP132	30677725
4,30	6	81	43	36	36	SCD361-0430-2-2-135HA08-HP132	30677726
4,40	6	81	43	36	36	SCD361-0440-2-2-135HA08-HP132	30677727
4,50	6	81	43	36	36	SCD361-0450-2-2-135HA08-HP132	30677728
4,60	6	81	43	36	36	SCD361-0460-2-2-135HA08-HP132	30677729
4,70	6	81	43	36	36	SCD361-0470-2-2-135HA08-HP132	30677730
4,80	6	95	57	48	36	SCD361-0480-2-2-135HA08-HP132	30677731
4,90	6	95	57	48	36	SCD361-0490-2-2-135HA08-HP132	30677732
5,00	6	95	57	48	36	SCD361-0500-2-2-135HA08-HP132	30677733
5,10	6	95	57	48	36	SCD361-0510-2-2-135HA08-HP132	30677734
5,20	6	95	57	48	36	SCD361-0520-2-2-135HA08-HP132	30677735
5,30	6	95	57	48	36	SCD361-0530-2-2-135HA08-HP132	30677736
5,50	6	95	57	48	36	SCD361-0550-2-2-135HA08-HP132	30677738
5,70	6	95	57	48	36	SCD361-0570-2-2-135HA08-HP132	30677740
5,80	6	95	57	48	36	SCD361-0580-2-2-135HA08-HP132	30677741
5,90	6	95	57	48	36	SCD361-0590-2-2-135HA08-HP132	30677742
6,00	6	95	57	48	36	SCD361-0600-2-2-135HA08-HP132	30677743
6,10	8	114	76	64	36	SCD361-0610-2-2-135HA08-HP132	30677744
6,20	8	114	76	64	36	SCD361-0620-2-2-135HA08-HP132	30677745
6,30	8	114	76	64	36	SCD361-0630-2-2-135HA08-HP132	30677746
6,50	8	114	76	64	36	SCD361-0650-2-2-135HA08-HP132	30677748
6,60	8	114	76	64	36	SCD361-0660-2-2-135HA08-HP132	30677749
6,70	8	114	76	64	36	SCD361-0670-2-2-135HA08-HP132	30677751

ECU-Drill-Steel | Broca helicoidal de metal duro SCD361 (8xD), suministro de refrigerante interior

Dimensiones						Forma del mango HA	
d ₁ h7	d ₂ h6	l ₁	l ₂	l ₃	l ₄	Especificación	Referencia
6,80	8	114	76	64	36	SCD361-0680-2-2-135HA08-HP132	30677752
6,90	8	114	76	64	36	SCD361-0690-2-2-135HA08-HP132	30677753
7,00	8	114	76	64	36	SCD361-0700-2-2-135HA08-HP132	30677754
7,10	8	114	76	64	36	SCD361-0710-2-2-135HA08-HP132	30677755
7,40	8	114	76	64	36	SCD361-0740-2-2-135HA08-HP132	30677758
7,50	8	114	76	64	36	SCD361-0750-2-2-135HA08-HP132	30677759
7,70	8	114	76	64	36	SCD361-0770-2-2-135HA08-HP132	30677761
7,80	8	114	76	64	36	SCD361-0780-2-2-135HA08-HP132	30677762
7,90	8	114	76	64	36	SCD361-0790-2-2-135HA08-HP132	30677763
8,00	8	114	76	64	36	SCD361-0800-2-2-135HA08-HP132	30677764
8,10	10	142	95	80	40	SCD361-0810-2-2-135HA08-HP132	30677765
8,20	10	142	95	80	40	SCD361-0820-2-2-135HA08-HP132	30677766
8,30	10	142	95	80	40	SCD361-0830-2-2-135HA08-HP132	30677767
8,50	10	142	95	80	40	SCD361-0850-2-2-135HA08-HP132	30677769
8,60	10	142	95	80	40	SCD361-0860-2-2-135HA08-HP132	30677770
8,70	10	142	95	80	40	SCD361-0870-2-2-135HA08-HP132	30677772
8,80	10	142	95	80	40	SCD361-0880-2-2-135HA08-HP132	30677773
9,00	10	142	95	80	40	SCD361-0900-2-2-135HA08-HP132	30677775
9,10	10	142	95	80	40	SCD361-0910-2-2-135HA08-HP132	30677776
9,20	10	142	95	80	40	SCD361-0920-2-2-135HA08-HP132	30677777
9,30	10	142	95	80	40	SCD361-0930-2-2-135HA08-HP132	30677778
9,40	10	142	95	80	40	SCD431-0940-2-2-135HA08-HP765	30550363
9,50	10	142	95	80	40	SCD361-0950-2-2-135HA08-HP132	30677780
9,70	10	142	95	80	40	SCD361-0970-2-2-135HA08-HP132	30677782
9,80	10	142	95	80	40	SCD361-0980-2-2-135HA08-HP132	30677783
9,90	10	142	95	80	40	SCD361-0990-2-2-135HA08-HP132	30677784
10,00	10	142	95	80	40	SCD361-1000-2-2-135HA08-HP132	30677785
10,20	12	162	114	96	45	SCD361-1020-2-2-135HA08-HP132	30677787
10,30	12	162	114	96	45	SCD361-1030-2-2-135HA08-HP132	30677788
10,50	12	162	114	96	45	SCD361-1050-2-2-135HA08-HP132	30677790
10,80	12	162	114	96	45	SCD361-1080-2-2-135HA08-HP132	30677793
11,00	12	162	114	96	45	SCD361-1100-2-2-135HA08-HP132	30677795
11,20	12	162	114	96	45	SCD361-1120-2-2-135HA08-HP132	30677797
11,50	12	162	114	96	45	SCD361-1150-2-2-135HA08-HP132	30677800
11,70	12	162	114	96	45	SCD361-1170-2-2-135HA08-HP132	30677802
11,80	12	162	114	96	45	SCD361-1180-2-2-135HA08-HP132	30677803
12,00	12	162	114	96	45	SCD361-1200-2-2-135HA08-HP132	30677805
12,20	14	178	133	112	45	SCD361-1220-2-2-135HA08-HP132	30677806
12,50	14	178	133	112	45	SCD361-1250-2-2-135HA08-HP132	30677807
12,80	14	178	133	112	45	SCD361-1280-2-2-135HA08-HP132	30677808
13,00	14	178	133	112	45	SCD361-1300-2-2-135HA08-HP132	30677809
13,50	14	178	133	112	45	SCD361-1350-2-2-135HA08-HP132	30677811
13,80	14	178	133	112	45	SCD361-1380-2-2-135HA08-HP132	30677812
14,00	14	178	133	112	45	SCD361-1400-2-2-135HA08-HP132	30677813
14,50	16	203	152	128	48	SCD361-1450-2-2-135HA08-HP132	30677815
15,00	16	203	152	128	48	SCD361-1500-2-2-135HA08-HP132	30677817
15,50	16	203	152	128	48	SCD361-1550-2-2-135HA08-HP132	30677818
15,80	16	203	152	128	48	SCD361-1580-2-2-135HA08-HP132	30677819
16,00	16	203	152	128	48	SCD361-1600-2-2-135HA08-HP132	30677820
16,50	18	222	171	144	48	SCD361-1650-2-2-135HA08-HP132	30677821
17,00	18	222	171	144	48	SCD361-1700-2-2-135HA08-HP132	30677822
17,50	18	222	171	144	48	SCD361-1750-2-2-135HA08-HP132	30677823
18,00	18	222	171	144	48	SCD361-1800-2-2-135HA08-HP132	30677824
18,50	20	243	190	160	50	SCD361-1850-2-2-135HA08-HP132	30677825
19,00	20	243	190	160	50	SCD361-1900-2-2-135HA08-HP132	30677826
20,00	20	243	190	160	50	SCD361-2000-2-2-135HA08-HP132	30677828

Continúa en la página siguiente.

ECU-Drill-Steel | Broca helicoidal de metal duro SCD361 (8xD), suministro de refrigerante interior

Características configurables



Forma del mango:
Forma del mango: HB | HE



Especificación
SCD361-0430-2-2-140[forma del mango]08-HP132

Ejemplo:
SCD361-0430-2-2-140HE08-HP132

Forma del mango HE

ECU-Drill-Steel

Broca helicoidal de metal duro
SCD361 (12xD), suministro de refrigerante interior

Ejecución:

Diámetro de broca: 3,00 - 18,00 mm
Tolerancia del agujero: \geq IT 9
Material de corte: HP132
Número de insertos: 2
Ángulo de la punta: 135°
Ángulo de hélice: 30°

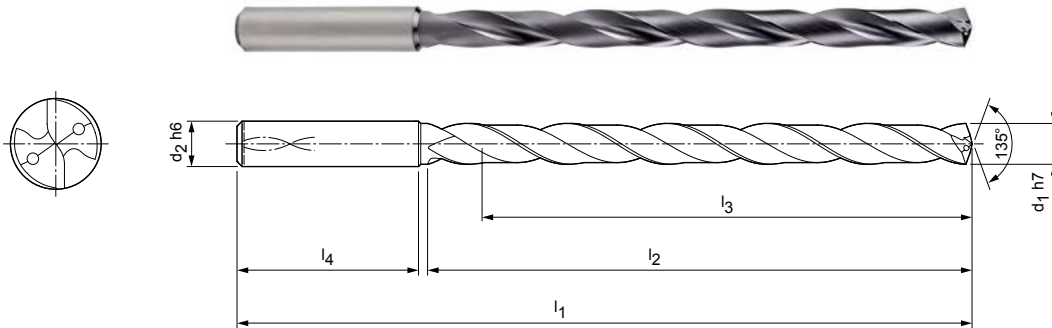

Serie preferente disponible en stock en forma de mango HA

Dimensiones						Forma del mango HA	
d_1 h7	d_2 h6	l_1	l_2	l_3	l_4	Especificación	Referencia
3,00	6	92	54	48	36	SCD361-0300-2-2-135HA12-HP132	30677829
3,10	6	92	54	48	36	SCD361-0310-2-2-135HA12-HP132	30677830
3,20	6	92	54	48	36	SCD361-0320-2-2-135HA12-HP132	30677831
3,30	6	92	54	48	36	SCD361-0330-2-2-135HA12-HP132	30677832
3,40	6	92	54	48	36	SCD361-0340-2-2-135HA12-HP132	30677833
3,50	6	92	54	48	36	SCD361-0350-2-2-135HA12-HP132	30677834
3,60	6	92	54	48	36	SCD361-0360-2-2-135HA12-HP132	30677835
3,70	6	92	54	48	36	SCD361-0370-2-2-135HA12-HP132	30677836
3,80	6	102	64	58	36	SCD361-0380-2-2-135HA12-HP132	30677837
3,90	6	102	64	58	36	SCD361-0390-2-2-135HA12-HP132	30677838
4,00	6	102	64	58	36	SCD361-0400-2-2-135HA12-HP132	30677839
4,10	6	102	64	58	36	SCD361-0410-2-2-135HA12-HP132	30677840
4,20	6	102	64	58	36	SCD361-0420-2-2-135HA12-HP132	30677841
4,30	6	102	64	58	36	SCD361-0430-2-2-135HA12-HP132	30677842
4,40	6	102	64	58	36	SCD361-0440-2-2-135HA12-HP132	30677843
4,50	6	102	64	58	36	SCD361-0450-2-2-135HA12-HP132	30677844
4,60	6	102	64	58	36	SCD361-0460-2-2-135HA12-HP132	30677845
4,70	6	102	64	58	36	SCD361-0470-2-2-135HA12-HP132	30677846
4,80	6	116	78	70	36	SCD361-0480-2-2-135HA12-HP132	30677847
4,90	6	116	78	70	36	SCD361-0490-2-2-135HA12-HP132	30677848
5,00	6	116	78	70	36	SCD361-0500-2-2-135HA12-HP132	30677849
5,10	6	116	78	70	36	SCD361-0510-2-2-135HA12-HP132	30677850
5,20	6	116	78	70	36	SCD361-0520-2-2-135HA12-HP132	30677851
5,50	6	116	78	70	36	SCD361-0550-2-2-135HA12-HP132	30677853
5,80	6	116	78	70	36	SCD361-0580-2-2-135HA12-HP132	30677854
6,00	6	116	78	70	36	SCD361-0600-2-2-135HA12-HP132	30677856
6,30	8	146	108	94	36	SCD361-0630-2-2-135HA12-HP132	30677859
6,50	8	146	108	94	36	SCD361-0650-2-2-135HA12-HP132	30677860
6,60	8	146	108	94	36	SCD361-0660-2-2-135HA12-HP132	30677861
6,80	8	146	108	94	36	SCD361-0680-2-2-135HA12-HP132	30677862
7,00	8	146	108	94	36	SCD361-0700-2-2-135HA12-HP132	30677863
7,40	8	146	108	94	36	SCD361-0740-2-2-135HA12-HP132	30677864
7,50	8	146	108	94	36	SCD361-0750-2-2-135HA12-HP132	30677865
7,80	8	146	108	94	36	SCD361-0780-2-2-135HA12-HP132	30677867
8,00	8	146	108	94	36	SCD361-0800-2-2-135HA12-HP132	30677869

Continúa en la página siguiente.

ECU-Drill-Steel | Broca helicoidal de metal duro SCD361 (12xD), suministro de refrigerante interior

Dimensiones						Forma del mango HA	
d ₁ h7	d ₂ h6	l ₁	l ₂	l ₃	l ₄	Especificación	Referencia
8,10	10	162	120	110	40	SCD361-0810-2-2-135HA12-HP132	30677870
8,20	10	162	120	110	40	SCD361-0820-2-2-135HA12-HP132	30677871
8,50	10	162	120	110	40	SCD361-0850-2-2-135HA12-HP132	30677874
9,00	10	162	120	110	40	SCD361-0900-2-2-135HA12-HP132	30677878
9,30	10	162	120	110	40	SCD361-0930-2-2-135HA12-HP132	30677881
9,50	10	162	120	110	40	SCD361-0950-2-2-135HA12-HP132	30677883
9,80	10	162	120	110	40	SCD361-0980-2-2-135HA12-HP132	30677885
10,00	10	162	120	110	40	SCD361-1000-2-2-135HA12-HP132	30677887
10,20	12	204	156	142	45	SCD361-1020-2-2-135HA12-HP132	30677888
10,50	12	204	156	142	45	SCD361-1050-2-2-135HA12-HP132	30677889
11,00	12	204	156	142	45	SCD361-1100-2-2-135HA12-HP132	30677891
11,50	12	204	156	142	45	SCD361-1150-2-2-135HA12-HP132	30677893
11,80	12	204	156	142	45	SCD361-1180-2-2-135HA12-HP132	30677894
12,00	12	204	156	142	45	SCD361-1200-2-2-135HA12-HP132	30677895
12,50	14	230	182	166	45	SCD361-1250-2-2-135HA12-HP132	30677896
13,00	14	230	182	166	45	SCD361-1300-2-2-135HA12-HP132	30677897
13,50	14	230	182	166	45	SCD361-1350-2-2-135HA12-HP132	30677899
14,00	14	230	182	166	45	SCD361-1400-2-2-135HA12-HP132	30677900
15,00	16	260	208	192	48	SCD361-1500-2-2-135HA12-HP132	30677903
16,00	16	260	208	192	48	SCD361-1600-2-2-135HA12-HP132	30677906
17,00	18	285	234	216	48	SCD361-1700-2-2-135HA12-HP132	30677908
17,50	18	285	234	216	48	SCD361-1750-2-2-135HA12-HP132	30677909
18,00	18	285	234	216	48	SCD361-1800-2-2-135HA12-HP132	30677910

Características configurables



Forma del mango:
Forma del mango: HB | HE



Especificación
SCD361-0430-2-2-140[forma del mango]12-HP132

Ejemplo:
SCD361-0430-2-2-140HE12-HP132

Forma del mango HE

Medidas en mm.

Para la recomendación de valores de corte, véase al final del capítulo.
Ejecuciones especiales y otros recubrimientos a petición.

MEGA-Drill-Inox

Broca helicoidal de metal duro

SCD120 (3xD), suministro de refrigerante exterior

Ejecución:

Diámetro de broca:	2,00 – 20,00 mm
Tolerancia del agujero:	≥ IT 9
Material de corte:	HP835
Número de insertos:	2
Número de biseles guía:	2
Ángulo de la punta:	140°
Ángulo de hélice:	30°

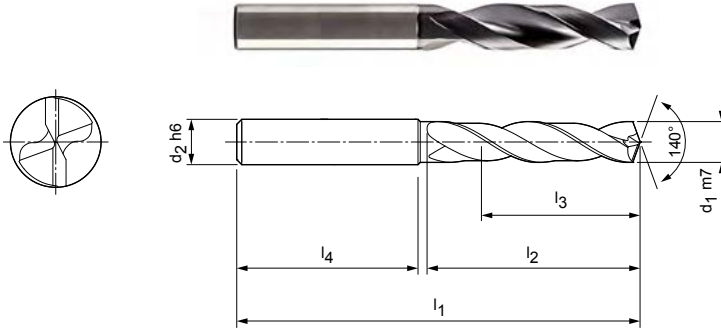

Serie preferente disponible en stock en forma de mango HA

Dimensiones						Forma del mango HA	
d ₁ m7	d ₂ h6	l ₁	l ₂	l ₃	l ₄	Especificación	Referencia
2,00	6	58	16	11	36	SCD120-0200-2-2-140HA03-HP835	30444703
2,10	6	58	16	11	36	SCD120-0210-2-2-140HA03-HP835	30453589
2,20	6	58	16	11	36	SCD120-0220-2-2-140HA03-HP835	30453826
2,30	6	58	16	11	36	SCD120-0230-2-2-140HA03-HP835	30453515
2,33	6	58	16	11	36	SCD120-0233-2-2-140HA03-HP835	30453605
2,40	6	58	16	11	36	SCD120-0240-2-2-140HA03-HP835	30444776
2,43	6	58	16	11	36	SCD120-0243-2-2-140HA03-HP835	30453606
2,50	6	58	16	11	36	SCD120-0250-2-2-140HA03-HP835	30451313
2,55	6	62	22	14	36	SCD120-0255-2-2-140HA03-HP835	30453607
2,60	6	58	16	11	36	SCD120-0260-2-2-140HA03-HP835	30453541
2,62	6	58	16	11	36	SCD120-0262-2-2-140HA03-HP835	30453608
2,70	6	58	16	11	36	SCD120-0270-2-2-140HA03-HP835	30453525
2,80	6	58	16	11	36	SCD120-0280-2-2-140HA03-HP835	30453502
2,90	6	58	16	11	36	SCD120-0290-2-2-140HA03-HP835	30453546
3,00	6	62	22	14	36	SCD120-0300-2-2-140HA03-HP835	30390310
3,10	6	62	22	14	36	SCD120-0310-2-2-140HA03-HP835	30390311
3,15	6	62	22	14	36	SCD120-0315-2-2-140HA03-HP835	30453609
3,20	6	62	22	14	36	SCD120-0320-2-2-140HA03-HP835	30390312
3,22	6	62	22	14	36	SCD120-0322-2-2-140HA03-HP835	30453610
3,25	6	62	22	14	36	SCD120-0325-2-2-140HA03-HP835	30453611
3,30	6	62	22	14	36	SCD120-0330-2-2-140HA03-HP835	30390313
3,40	6	62	22	14	36	SCD120-0340-2-2-140HA03-HP835	30390314
3,50	6	62	22	14	36	SCD120-0350-2-2-140HA03-HP835	30390315
3,60	6	62	22	14	36	SCD120-0360-2-2-140HA03-HP835	30390316
3,70	6	62	22	14	36	SCD120-0370-2-2-140HA03-HP835	30390317
3,80	6	66	26	17	36	SCD120-0380-2-2-140HA03-HP835	30390318
3,90	6	66	26	17	36	SCD120-0390-2-2-140HA03-HP835	30390319
4,00	6	66	26	17	36	SCD120-0400-2-2-140HA03-HP835	30390320
4,05	6	66	26	17	36	SCD120-0405-2-2-140HA03-HP835	30445425
4,10	6	66	26	17	36	SCD120-0410-2-2-140HA03-HP835	30390321
4,20	6	66	26	17	36	SCD120-0420-2-2-140HA03-HP835	30390322
4,30	6	66	26	17	36	SCD120-0430-2-2-140HA03-HP835	30390323
4,35	6	66	26	17	36	SCD120-0435-2-2-140HA03-HP835	30453613
4,40	6	66	26	17	36	SCD120-0440-2-2-140HA03-HP835	30390324
4,50	6	66	26	17	36	SCD120-0450-2-2-140HA03-HP835	30390325

Continúa en la página siguiente.

MEGA-Drill-Inox | Broca helicoidal de metal duro SCD120 (3xD), suministro de refrigerante exterior

Dimensiones						Forma del mango HA	
d ₁ m7	d ₂ h6	l ₁	l ₂	l ₃	l ₄	Especificación	Referencia
4,60	6	66	26	17	36	SCD120-0460-2-2-140HA03-HP835	30390326
4,65	6	66	26	17	36	SCD120-0465-2-2-140HA03-HP835	30452080
4,70	6	66	26	17	36	SCD120-0470-2-2-140HA03-HP835	30390327
4,80	6	66	30	20	36	SCD120-0480-2-2-140HA03-HP835	30390328
4,90	6	66	30	20	36	SCD120-0490-2-2-140HA03-HP835	30390329
5,00	6	66	30	20	36	SCD120-0500-2-2-140HA03-HP835	30390330
5,03	6	66	30	20	36	SCD120-0503-2-2-140HA03-HP835	30453912
5,10	6	66	30	20	36	SCD120-0510-2-2-140HA03-HP835	30390331
5,20	6	66	30	20	36	SCD120-0520-2-2-140HA03-HP835	30390332
5,30	6	66	30	20	36	SCD120-0530-2-2-140HA03-HP835	30390333
5,40	6	66	30	20	36	SCD120-0540-2-2-140HA03-HP835	30390334
5,50	6	66	30	20	36	SCD120-0550-2-2-140HA03-HP835	30390335
5,55	6	66	30	20	36	SCD120-0555-2-2-140HA03-HP835	30452081
5,60	6	66	30	20	36	SCD120-0560-2-2-140HA03-HP835	30390336
5,70	6	66	30	20	36	SCD120-0570-2-2-140HA03-HP835	30390337
5,80	6	66	30	20	36	SCD120-0580-2-2-140HA03-HP835	30390338
5,90	6	66	30	20	36	SCD120-0590-2-2-140HA03-HP835	30390339
6,00	6	66	30	20	36	SCD120-0600-2-2-140HA03-HP835	30390340
6,10	8	79	38	24	36	SCD120-0610-2-2-140HA03-HP835	30390341
6,20	8	79	38	24	36	SCD120-0620-2-2-140HA03-HP835	30390342
6,30	8	79	38	24	36	SCD120-0630-2-2-140HA03-HP835	30390343
6,40	8	79	38	24	36	SCD120-0640-2-2-140HA03-HP835	30390344
6,50	8	79	38	24	36	SCD120-0650-2-2-140HA03-HP835	30390345
6,60	8	79	38	24	36	SCD120-0660-2-2-140HA03-HP835	30390346
6,70	8	79	38	24	36	SCD120-0670-2-2-140HA03-HP835	30390347
6,80	8	79	38	24	36	SCD120-0680-2-2-140HA03-HP835	30390348
6,90	8	79	38	24	36	SCD120-0690-2-2-140HA03-HP835	30390349
7,00	8	79	38	24	36	SCD120-0700-2-2-140HA03-HP835	30390350
7,20	8	79	42	29	36	SCD120-0720-2-2-140HA03-HP835	30390352
7,40	8	79	42	29	36	SCD120-0740-2-2-140HA03-HP835	30390354
7,45	8	79	42	29	36	SCD120-0745-2-2-140HA03-HP835	30453616
7,50	8	79	42	29	36	SCD120-0750-2-2-140HA03-HP835	30390355
7,70	8	79	42	29	36	SCD120-0770-2-2-140HA03-HP835	30390357
7,80	8	79	42	29	36	SCD120-0780-2-2-140HA03-HP835	30390358
7,90	8	79	42	29	36	SCD120-0790-2-2-140HA03-HP835	30390359
8,00	8	79	42	29	36	SCD120-0800-2-2-140HA03-HP835	30390360
8,10	10	89	49	35	40	SCD120-0810-2-2-140HA03-HP835	30390361
8,20	10	89	49	35	40	SCD120-0820-2-2-140HA03-HP835	30390362
8,30	10	89	49	35	40	SCD120-0830-2-2-140HA03-HP835	30390363
8,40	10	89	49	35	40	SCD120-0840-2-2-140HA03-HP835	30390364
8,50	10	89	49	35	40	SCD120-0850-2-2-140HA03-HP835	30390365
8,60	10	89	49	35	40	SCD120-0860-2-2-140HA03-HP835	30390366
8,70	10	89	49	35	40	SCD120-0870-2-2-140HA03-HP835	30390367
8,80	10	89	49	35	40	SCD120-0880-2-2-140HA03-HP835	30390368
8,90	10	89	49	35	40	SCD120-0890-2-2-140HA03-HP835	30390369
9,00	10	89	49	35	40	SCD120-0900-2-2-140HA03-HP835	30390370
9,10	10	89	49	35	40	SCD120-0910-2-2-140HA03-HP835	30390371
9,50	10	89	49	35	40	SCD120-0950-2-2-140HA03-HP835	30390375
9,80	10	89	49	35	40	SCD120-0980-2-2-140HA03-HP835	30390378
9,90	10	89	49	35	40	SCD120-0990-2-2-140HA03-HP835	30390379
10,00	10	89	49	35	40	SCD120-1000-2-2-140HA03-HP835	30390380
10,10	12	102	56	40	45	SCD120-1010-2-2-140HA03-HP835	30390381
10,20	12	102	56	40	45	SCD120-1020-2-2-140HA03-HP835	30390382
10,30	12	102	56	40	45	SCD120-1030-2-2-140HA03-HP835	30390383
10,50	12	102	56	40	45	SCD120-1050-2-2-140HA03-HP835	30390385
11,00	12	102	56	40	45	SCD120-1100-2-2-140HA03-HP835	30390390
11,50	12	102	56	40	45	SCD120-1150-2-2-140HA03-HP835	30390395

MEGA-Drill-Inox | Broca helicoidal de metal duro SCD120 (3xD), suministro de refrigerante exterior

Dimensiones						Forma del mango HA	
d ₁ m7	d ₂ h6	l ₁	l ₂	l ₃	l ₄	Especificación	Referencia
11,80	12	102	56	40	45	SCD120-1180-2-2-140HA03-HP835	30390398
12,00	12	102	56	40	45	SCD120-1200-2-2-140HA03-HP835	30390400
12,15	14	107	61	43	45	SCD120-1215-2-2-140HA03-HP835	30453623
12,50	14	107	61	43	45	SCD120-1250-2-2-140HA03-HP835	30390401
12,80	14	107	61	43	45	SCD120-1280-2-2-140HA03-HP835	30445978
13,00	14	107	61	43	45	SCD120-1300-2-2-140HA03-HP835	30390402
13,80	14	107	61	43	45	SCD120-1380-2-2-140HA03-HP835	30445979
14,00	14	107	61	43	45	SCD120-1400-2-2-140HA03-HP835	30390404
15,00	16	115	65	45	48	SCD120-1500-2-2-140HA03-HP835	30390406
16,00	16	115	65	45	48	SCD120-1600-2-2-140HA03-HP835	30390408
17,00	18	123	73	51	48	SCD120-1700-2-2-140HA03-HP835	30390410
18,00	18	123	73	51	48	SCD120-1800-2-2-140HA03-HP835	30390412
19,00	20	131	79	55	50	SCD120-1900-2-2-140HA03-HP835	30390414

Características configurables

**Diámetro:**

Diámetro seleccionable libremente en incrementos de 0,01 mm

**Forma del mango:**

Forma del mango: HB | HE

Especificación

SCD120-[diámetro]-2-2-140[forma del mango]03-HP835

Dimensiones de la serie configurable

d ₁ min.	d ₁ max.	d ₂ h6	l ₁	l ₂	l ₃	l ₄
3,00	3,70	6	62	22	14	36
3,71	4,70	6	66	26	17	36
4,71	6,00	6	66	30	20	36
6,01	7,00	8	79	38	24	36
7,01	8,00	8	79	42	29	36
8,01	10,00	10	89	49	35	40
10,01	12,00	12	102	56	40	45
12,01	14,00	14	107	61	43	45
14,01	16,00	16	115	65	45	48
16,01	18,00	18	123	73	51	48
18,01	20,00	20	131	79	55	50

Ejemplo:

SCD120-0431-2-2-140HE03-HP835

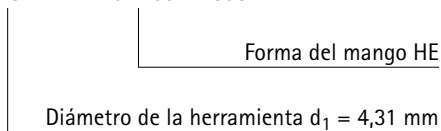

Medidas en mm.

Para la recomendación de valores de corte, véase al final del capítulo.

Ejecuciones especiales y otros recubrimientos a petición.

MEGA-Drill-Inox

Broca helicoidal de metal duro

SCD121 (3xD), suministro de refrigerante interior

Ejecución:

Diámetro de broca: 3,00 – 20,00 mm

Tolerancia del agujero: \geq IT 9

Material de corte: HP835

Número de insertos: 2

Número de biseles guía: 2

Ángulo de la punta: 140°

Ángulo de hélice: 30°

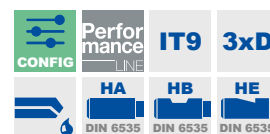
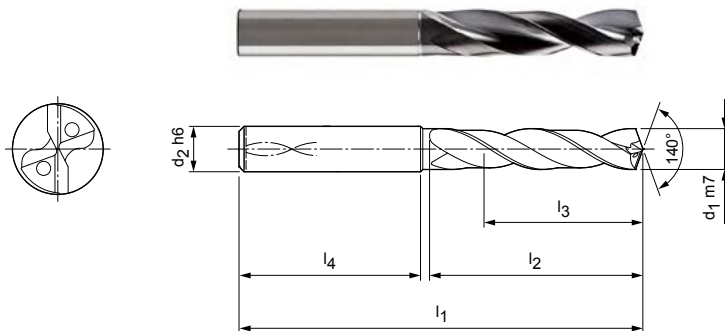

Serie preferente disponible en stock en forma de mango HA

Dimensiones						Forma del mango HA	
d ₁ m7	d ₂ h6	l ₁	l ₂	l ₃	l ₄	Especificación	Referencia
3,00	6	62	22	14	36	SCD121-0300-2-2-140HA03-HP835	30390523
3,05	6	62	22	14	36	SCD121-0305-2-2-140HA03-HP835	30445910
3,15	6	62	22	14	36	SCD121-0315-2-2-140HA03-HP835	30453629
3,20	6	62	22	14	36	SCD121-0320-2-2-140HA03-HP835	30390525
3,25	6	62	22	14	36	SCD121-0325-2-2-140HA03-HP835	30453631
3,30	6	62	22	14	36	SCD121-0330-2-2-140HA03-HP835	30390526
3,40	6	62	22	14	36	SCD121-0340-2-2-140HA03-HP835	30390527
3,50	6	62	22	14	36	SCD121-0350-2-2-140HA03-HP835	30390528
3,60	6	62	22	14	36	SCD121-0360-2-2-140HA03-HP835	30390529
3,70	6	62	22	14	36	SCD121-0370-2-2-140HA03-HP835	30390530
3,80	6	66	26	17	36	SCD121-0380-2-2-140HA03-HP835	30390531
3,90	6	66	26	17	36	SCD121-0390-2-2-140HA03-HP835	30390532
4,00	6	66	26	17	36	SCD121-0400-2-2-140HA03-HP835	30390533
4,10	6	66	26	17	36	SCD121-0410-2-2-140HA03-HP835	30390534
4,20	6	66	26	17	36	SCD121-0420-2-2-140HA03-HP835	30390535
4,30	6	66	26	17	36	SCD121-0430-2-2-140HA03-HP835	30390536
4,35	6	66	26	17	36	SCD121-0435-2-2-140HA03-HP835	30453633
4,40	6	66	26	17	36	SCD121-0440-2-2-140HA03-HP835	30390537
4,50	6	66	26	17	36	SCD121-0450-2-2-140HA03-HP835	30390538
4,65	6	66	26	17	36	SCD121-0465-2-2-140HA03-HP835	30438861
4,70	6	66	26	17	36	SCD121-0470-2-2-140HA03-HP835	30390540
4,80	6	66	30	20	36	SCD121-0480-2-2-140HA03-HP835	30390541
5,00	6	66	30	20	36	SCD121-0500-2-2-140HA03-HP835	30390543
5,10	6	66	30	20	36	SCD121-0510-2-2-140HA03-HP835	30390544
5,20	6	66	30	20	36	SCD121-0520-2-2-140HA03-HP835	30390545
5,30	6	66	30	20	36	SCD121-0530-2-2-140HA03-HP835	30390546
5,40	6	66	30	20	36	SCD121-0540-2-2-140HA03-HP835	30390547
5,50	6	66	30	20	36	SCD121-0550-2-2-140HA03-HP835	30390548
5,55	6	66	30	20	36	SCD121-0555-2-2-140HA03-HP835	30439052
5,60	6	66	30	20	36	SCD121-0560-2-2-140HA03-HP835	30390549
5,70	6	66	30	20	36	SCD121-0570-2-2-140HA03-HP835	30390550
5,80	6	66	30	20	36	SCD121-0580-2-2-140HA03-HP835	30390551
5,90	6	66	30	20	36	SCD121-0590-2-2-140HA03-HP835	30390552
5,95	6	66	30	20	36	SCD121-0595-2-2-140HA03-HP835	30453636
6,00	6	66	30	20	36	SCD121-0600-2-2-140HA03-HP835	30390553

MEGA-Drill-Inox | Broca helicoidal de metal duro SCD121 (3xD), suministro de refrigerante interior

Dimensiones						Forma del mango HA	
d ₁ m7	d ₂ h6	l ₁	l ₂	l ₃	l ₄	Especificación	Referencia
6,10	8	79	38	24	36	SCD121-0610-2-2-140HA03-HP835	30390554
6,20	8	79	38	24	36	SCD121-0620-2-2-140HA03-HP835	30390555
6,30	8	79	38	24	36	SCD121-0630-2-2-140HA03-HP835	30390556
6,40	8	79	38	24	36	SCD121-0640-2-2-140HA03-HP835	30390557
6,50	8	79	38	24	36	SCD121-0650-2-2-140HA03-HP835	30390558
6,60	8	79	38	24	36	SCD121-0660-2-2-140HA03-HP835	30390559
6,70	8	79	38	24	36	SCD121-0670-2-2-140HA03-HP835	30390560
6,80	8	79	38	24	36	SCD121-0680-2-2-140HA03-HP835	30390561
6,90	8	79	38	24	36	SCD121-0690-2-2-140HA03-HP835	30390562
7,00	8	79	38	24	36	SCD121-0700-2-2-140HA03-HP835	30390563
7,10	8	79	42	29	36	SCD121-0710-2-2-140HA03-HP835	30390564
7,20	8	79	42	29	36	SCD121-0720-2-2-140HA03-HP835	30390565
7,30	8	79	42	29	36	SCD121-0730-2-2-140HA03-HP835	30390566
7,40	8	79	42	29	36	SCD121-0740-2-2-140HA03-HP835	30390567
7,45	8	79	42	29	36	SCD121-0745-2-2-140HA03-HP835	30453637
7,50	8	79	42	29	36	SCD121-0750-2-2-140HA03-HP835	30390568
7,70	8	79	42	29	36	SCD121-0770-2-2-140HA03-HP835	30390570
7,80	8	79	42	29	36	SCD121-0780-2-2-140HA03-HP835	30390571
7,90	8	79	42	29	36	SCD121-0790-2-2-140HA03-HP835	30390572
8,00	8	79	42	29	36	SCD121-0800-2-2-140HA03-HP835	30390573
8,10	10	89	49	35	40	SCD121-0810-2-2-140HA03-HP835	30390574
8,20	10	89	49	35	40	SCD121-0820-2-2-140HA03-HP835	30390575
8,30	10	89	49	35	40	SCD121-0830-2-2-140HA03-HP835	30390576
8,40	10	89	49	35	40	SCD121-0840-2-2-140HA03-HP835	30390577
8,50	10	89	49	35	40	SCD121-0850-2-2-140HA03-HP835	30390578
8,60	10	89	49	35	40	SCD121-0860-2-2-140HA03-HP835	30390579
8,70	10	89	49	35	40	SCD121-0870-2-2-140HA03-HP835	30390580
8,80	10	89	49	35	40	SCD121-0880-2-2-140HA03-HP835	30390581
9,00	10	89	49	35	40	SCD121-0900-2-2-140HA03-HP835	30390583
9,10	10	89	49	35	40	SCD121-0910-2-2-140HA03-HP835	30390584
9,20	10	89	49	35	40	SCD121-0920-2-2-140HA03-HP835	30390585
9,30	10	89	49	35	40	SCD121-0930-2-2-140HA03-HP835	30390586
9,35	10	89	49	35	40	SCD121-0935-2-2-140HA03-HP835	30450663
9,40	10	89	49	35	40	SCD121-0940-2-2-140HA03-HP835	30390587
9,50	10	89	49	35	40	SCD121-0950-2-2-140HA03-HP835	30390588
9,70	10	89	49	35	40	SCD121-0970-2-2-140HA03-HP835	30390590
9,80	10	89	49	35	40	SCD121-0980-2-2-140HA03-HP835	30390591
9,90	10	89	49	35	40	SCD121-0990-2-2-140HA03-HP835	30390592
10,00	10	89	49	35	40	SCD121-1000-2-2-140HA03-HP835	30390593
10,20	12	102	56	40	45	SCD121-1020-2-2-140HA03-HP835	30390595
10,30	12	102	56	40	45	SCD121-1030-2-2-140HA03-HP835	30390596
10,40	12	102	56	40	45	SCD121-1040-2-2-140HA03-HP835	30390597
10,50	12	102	56	40	45	SCD121-1050-2-2-140HA03-HP835	30390598
10,70	12	102	56	40	45	SCD121-1070-2-2-140HA03-HP835	30390600
10,80	12	102	56	40	45	SCD121-1080-2-2-140HA03-HP835	30390601
11,00	12	102	56	40	45	SCD121-1100-2-2-140HA03-HP835	30390603
11,10	12	102	56	40	45	SCD121-1110-2-2-140HA03-HP835	30390604
11,30	12	102	56	40	45	SCD121-1130-2-2-140HA03-HP835	30390606
11,50	12	102	56	40	45	SCD121-1150-2-2-140HA03-HP835	30390608
11,70	12	102	56	40	45	SCD121-1170-2-2-140HA03-HP835	30390610
11,80	12	102	56	40	45	SCD121-1180-2-2-140HA03-HP835	30390611
12,00	12	102	56	40	45	SCD121-1200-2-2-140HA03-HP835	30390613
12,15	14	107	61	43	45	SCD121-1215-2-2-140HA03-HP835	30453644
12,50	14	107	61	43	45	SCD121-1250-2-2-140HA03-HP835	30443976
12,80	14	107	61	43	45	SCD121-1280-2-2-140HA03-HP835	30445992
13,00	14	107	61	43	45	SCD121-1300-2-2-140HA03-HP835	30444778
13,50	14	107	61	43	45	SCD121-1350-2-2-140HA03-HP835	30390614

Continúa en la página siguiente.

MEGA-Drill-Inox | Broca helicoidal de metal duro SCD121 (3xD), suministro de refrigerante interior

Dimensiones						Forma del mango HA	
d ₁ m7	d ₂ h6	l ₁	l ₂	l ₃	l ₄	Especificación	Referencia
13,80	14	107	61	43	45	SCD121-1380-2-2-140HA03-HP835	30445993
14,00	14	107	61	43	45	SCD121-1400-2-2-140HA03-HP835	30445050
14,50	16	115	65	45	48	SCD121-1450-2-2-140HA03-HP835	30390615
15,00	16	115	65	45	48	SCD121-1500-2-2-140HA03-HP835	30390616
15,50	16	115	65	45	48	SCD121-1550-2-2-140HA03-HP835	30442531
15,80	16	115	65	45	48	SCD121-1580-2-2-140HA03-HP835	30445995
16,00	16	115	65	45	48	SCD121-1600-2-2-140HA03-HP835	30390617
17,50	18	123	73	51	48	SCD121-1750-2-2-140HA03-HP835	30390620
18,00	18	123	73	51	48	SCD121-1800-2-2-140HA03-HP835	30390621
20,00	20	131	79	55	50	SCD121-2000-2-2-140HA03-HP835	30390625

Características configurables

**Diámetro:**

Diámetro seleccionable libremente en incrementos de 0,01 mm

**Forma del mango:**

Forma del mango: HB | HE

Especificación

SCD121-[diámetro]-2-2-140[forma del mango]03-HP835

Dimensiones de la serie configurable

d ₁ min.	d ₁ max.	d ₂ h6	l ₁	l ₂	l ₃	l ₄
3,71	4,70	6	66	26	17	36
4,71	6,00	6	66	30	20	36
6,01	7,00	8	79	38	24	36
7,01	8,00	8	79	42	29	36
8,01	10,00	10	89	49	35	40
10,01	12,00	12	102	56	40	45
12,01	14,00	14	107	61	43	45
14,01	16,00	16	115	65	45	48
16,01	18,00	18	123	73	51	48
18,01	20,00	20	131	79	55	50
18,01	20,00	20	131	79	55	50

Ejemplo:

SCD121-0431-2-2-140HE03-HP835

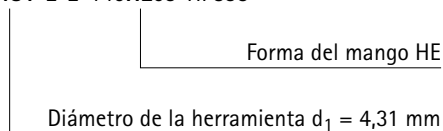

Medidas en mm.

Para la recomendación de valores de corte, véase al final del capítulo.

Ejecuciones especiales y otros recubrimientos a petición.

MEGA-Drill-Inox

Broca helicoidal de metal duro

SCD120 (5xD), suministro de refrigerante exterior

Ejecución:

Diámetro de broca:	3,00 – 20,00 mm
Tolerancia del agujero:	≥ IT 9
Material de corte:	HP835
Número de insertos:	2
Número de biseles guía:	2
Ángulo de la punta:	140°
Ángulo de hélice:	30°

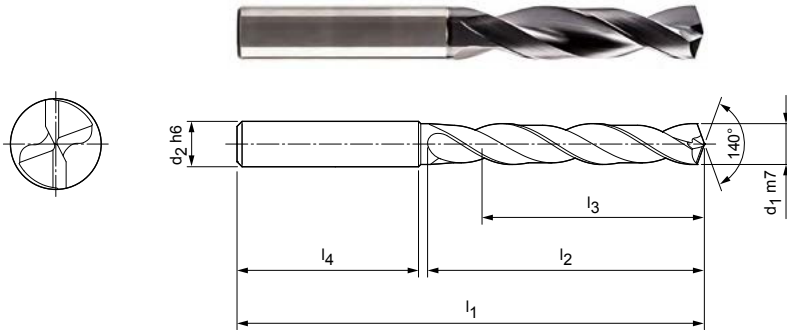

Serie preferente disponible en stock en forma de mango HA

Dimensiones						Forma del mango HA	
d ₁ m7	d ₂ h6	l ₁	l ₂	l ₃	l ₄	Especificación	Referencia
3,00	6	66	28	23	36	SCD120-0300-2-2-140HA05-HP835	30390730
3,10	6	66	28	23	36	SCD120-0310-2-2-140HA05-HP835	30390731
3,20	6	66	28	23	36	SCD120-0320-2-2-140HA05-HP835	30390732
3,30	6	66	28	23	36	SCD120-0330-2-2-140HA05-HP835	30390733
3,40	6	66	28	23	36	SCD120-0340-2-2-140HA05-HP835	30390734
3,50	6	66	28	23	36	SCD120-0350-2-2-140HA05-HP835	30390735
3,60	6	66	28	23	36	SCD120-0360-2-2-140HA05-HP835	30390736
3,70	6	66	28	23	36	SCD120-0370-2-2-140HA05-HP835	30390737
3,80	6	74	36	29	36	SCD120-0380-2-2-140HA05-HP835	30390738
3,90	6	74	36	29	36	SCD120-0390-2-2-140HA05-HP835	30390739
4,00	6	74	36	29	36	SCD120-0400-2-2-140HA05-HP835	30390740
4,10	6	74	36	29	36	SCD120-0410-2-2-140HA05-HP835	30390741
4,20	6	74	36	29	36	SCD120-0420-2-2-140HA05-HP835	30390742
4,30	6	74	36	29	36	SCD120-0430-2-2-140HA05-HP835	30390743
4,40	6	74	36	29	36	SCD120-0440-2-2-140HA05-HP835	30390744
4,50	6	74	36	29	36	SCD120-0450-2-2-140HA05-HP835	30390745
4,60	6	74	36	29	36	SCD120-0460-2-2-140HA05-HP835	30390746
4,70	6	74	36	29	36	SCD120-0470-2-2-140HA05-HP835	30390747
4,80	6	82	44	35	36	SCD120-0480-2-2-140HA05-HP835	30390748
4,90	6	82	44	35	36	SCD120-0490-2-2-140HA05-HP835	30390749
5,00	6	82	44	35	36	SCD120-0500-2-2-140HA05-HP835	30390750
5,10	6	82	44	35	36	SCD120-0510-2-2-140HA05-HP835	30390751
5,20	6	82	44	35	36	SCD120-0520-2-2-140HA05-HP835	30390752
5,30	6	82	44	35	36	SCD120-0530-2-2-140HA05-HP835	30390753
5,40	6	82	44	35	36	SCD120-0540-2-2-140HA05-HP835	30390754
5,50	6	82	44	35	36	SCD120-0550-2-2-140HA05-HP835	30390755
5,60	6	82	44	35	36	SCD120-0560-2-2-140HA05-HP835	30390756
5,80	6	82	44	35	36	SCD120-0580-2-2-140HA05-HP835	30390758
6,00	6	82	44	35	36	SCD120-0600-2-2-140HA05-HP835	30390760
6,10	8	91	53	43	36	SCD120-0610-2-2-140HA05-HP835	30390761
6,20	8	91	53	43	36	SCD120-0620-2-2-140HA05-HP835	30390762
6,30	8	91	53	43	36	SCD120-0630-2-2-140HA05-HP835	30390763
6,40	8	91	53	43	36	SCD120-0640-2-2-140HA05-HP835	30390764
6,50	8	91	53	43	36	SCD120-0650-2-2-140HA05-HP835	30390765
6,60	8	91	53	43	36	SCD120-0660-2-2-140HA05-HP835	30390766

Continúa en la página siguiente.

MEGA-Drill-Inox | Broca helicoidal de metal duro SCD120 (5xD), suministro de refrigerante exterior

Dimensiones						Forma del mango HA	
d ₁ m7	d ₂ h6	l ₁	l ₂	l ₃	l ₄	Especificación	Referencia
6,70	8	91	53	43	36	SCD120-0670-2-2-140HA05-HP835	30390767
6,80	8	91	53	43	36	SCD120-0680-2-2-140HA05-HP835	30390768
6,90	8	91	53	43	36	SCD120-0690-2-2-140HA05-HP835	30390769
7,00	8	91	53	43	36	SCD120-0700-2-2-140HA05-HP835	30390770
7,10	8	91	53	43	36	SCD120-0710-2-2-140HA05-HP835	30390771
7,40	8	91	53	43	36	SCD120-0740-2-2-140HA05-HP835	30390774
7,50	8	91	53	43	36	SCD120-0750-2-2-140HA05-HP835	30390775
7,60	8	91	53	43	36	SCD120-0760-2-2-140HA05-HP835	30390776
7,80	8	91	53	43	36	SCD120-0780-2-2-140HA05-HP835	30390778
7,90	8	91	53	43	36	SCD120-0790-2-2-140HA05-HP835	30390779
8,00	8	91	53	43	36	SCD120-0800-2-2-140HA05-HP835	30390780
8,10	10	103	61	49	40	SCD120-0810-2-2-140HA05-HP835	30390781
8,20	10	103	61	49	40	SCD120-0820-2-2-140HA05-HP835	30390782
8,50	10	103	61	49	40	SCD120-0850-2-2-140HA05-HP835	30390785
8,60	10	103	61	49	40	SCD120-0860-2-2-140HA05-HP835	30390786
8,70	10	103	61	49	40	SCD120-0870-2-2-140HA05-HP835	30390787
8,80	10	103	61	49	40	SCD120-0880-2-2-140HA05-HP835	30390788
9,00	10	103	61	49	40	SCD120-0900-2-2-140HA05-HP835	30390790
9,20	10	103	61	49	40	SCD120-0920-2-2-140HA05-HP835	30390792
9,30	10	103	61	49	40	SCD120-0930-2-2-140HA05-HP835	30390793
9,40	10	103	61	49	40	SCD120-0940-2-2-140HA05-HP835	30390794
9,50	10	103	61	49	40	SCD120-0950-2-2-140HA05-HP835	30390795
10,00	10	103	61	49	40	SCD120-1000-2-2-140HA05-HP835	30390800
10,20	12	118	71	56	45	SCD120-1020-2-2-140HA05-HP835	30390802
10,30	12	118	71	56	45	SCD120-1030-2-2-140HA05-HP835	30390803
10,50	12	118	71	56	45	SCD120-1050-2-2-140HA05-HP835	30390805
10,80	12	118	71	56	45	SCD120-1080-2-2-140HA05-HP835	30390808
11,00	12	118	71	56	45	SCD120-1100-2-2-140HA05-HP835	30390810
11,70	12	118	71	56	45	SCD120-1170-2-2-140HA05-HP835	30390817
11,80	12	118	71	56	45	SCD120-1180-2-2-140HA05-HP835	30390818
12,00	12	118	71	56	45	SCD120-1200-2-2-140HA05-HP835	30390820
12,50	14	124	77	60	45	SCD120-1250-2-2-140HA05-HP835	30390821
13,00	14	124	77	60	45	SCD120-1300-2-2-140HA05-HP835	30390822
16,00	16	133	83	63	48	SCD120-1600-2-2-140HA05-HP835	30390828
16,50	18	143	93	71	48	SCD120-1650-2-2-140HA05-HP835	30445987

Características configurables

**Diámetro:**

Diámetro seleccionable libremente en incrementos de 0,01 mm

**Forma del mango:**

Forma del mango: HB | HE

Especificación

SCD120-[diámetro]-2-2-140[forma del mango]05-HP835

Dimensiones de la serie configurable

d ₁ min.	d ₁ max.	d ₂ h6	l ₁	l ₂	l ₃	l ₄
3,00	3,70	6	66	66	23	36
3,71	4,70	6	74	74	29	36
4,71	6,00	6	82	44	35	36
6,01	8,00	8	91	53	43	36
8,01	10,00	10	103	61	49	40
10,01	12,00	12	118	71	56	45
12,01	14,00	14	124	77	60	45
14,01	16,00	16	133	83	63	48
16,01	18,00	18	143	93	71	48
18,01	20,00	20	153	101	77	50

Ejemplo:

SCD120-0431-2-2-140HE05-HP835

Forma del mango HE

Diámetro de la herramienta d₁ = 4,31 mm

Medidas en mm.

Para la recomendación de valores de corte, véase al final del capítulo.

Ejecuciones especiales y otros recubrimientos a petición.

MEGA-Drill-Inox

Broca helicoidal de metal duro

SCD121 (5xD), suministro de refrigerante interior

Ejecución:

Diámetro de broca:	2,80 – 20,00 mm
Tolerancia del agujero:	≥ IT 9
Material de corte:	HP835
Número de insertos:	2
Número de biseles guía:	2
Ángulo de la punta:	140°
Ángulo de hélice:	30°

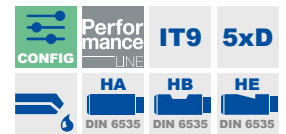
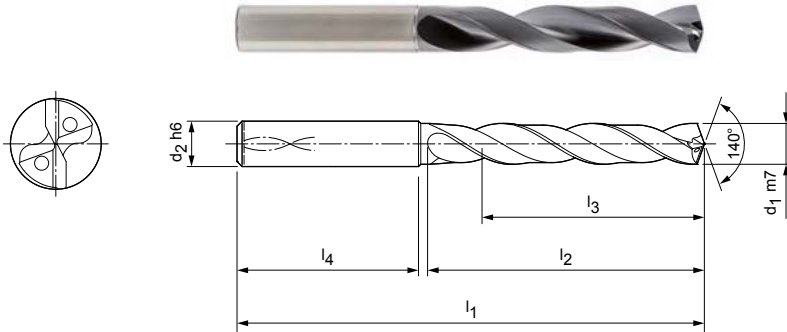

Serie preferente disponible en stock en forma de mango HA

Dimensiones						Forma del mango HA	
d ₁ m7	d ₂ h6	l ₁	l ₂	l ₃	l ₄	Especificación	Referencia
2,80	6	66	28	23	36	SCD121-0280-2-2-140HA05-HP835	30453905
3,00	6	66	28	23	36	SCD121-0300-2-2-140HA05-HP835	30390951
3,10	6	66	28	23	36	SCD121-0310-2-2-140HA05-HP835	30390952
3,15	6	66	28	23	36	SCD121-0315-2-2-140HA05-HP835	30430429
3,20	6	66	28	23	36	SCD121-0320-2-2-140HA05-HP835	30390953
3,22	6	66	28	23	36	SCD121-0322-2-2-140HA05-HP835	30453650
3,25	6	66	28	23	36	SCD121-0325-2-2-140HA05-HP835	30453651
3,30	6	66	28	23	36	SCD121-0330-2-2-140HA05-HP835	30390954
3,40	6	66	28	23	36	SCD121-0340-2-2-140HA05-HP835	30390955
3,50	6	66	28	23	36	SCD121-0350-2-2-140HA05-HP835	30390956
3,60	6	66	28	23	36	SCD121-0360-2-2-140HA05-HP835	30390957
3,70*	6	66	28	23	36	SCD121-0370-2-2-140HA05-HP835	30390958
3,80	6	74	36	29	36	SCD121-0380-2-2-140HA05-HP835	30390959
3,90	6	74	36	29	36	SCD121-0390-2-2-140HA05-HP835	30390960
4,00	6	74	36	29	36	SCD121-0400-2-2-140HA05-HP835	30390961
4,10	6	74	36	29	36	SCD121-0410-2-2-140HA05-HP835	30390962
4,15	6	74	36	29	36	SCD121-0415-2-2-140HA05-HP835	30454007
4,20	6	74	36	29	36	SCD121-0420-2-2-140HA05-HP835	30390963
4,30	6	74	36	29	36	SCD121-0430-2-2-140HA05-HP835	30390964
4,40	6	74	36	29	36	SCD121-0440-2-2-140HA05-HP835	30390965
4,45	6	74	36	29	36	SCD121-0445-2-2-140HA05-HP835	30453654
4,50	6	74	36	29	36	SCD121-0450-2-2-140HA05-HP835	30390966
4,60	6	74	36	29	36	SCD121-0460-2-2-140HA05-HP835	30390967
4,65*	6	74	36	29	36	SCD121-0465-2-2-140HA05-HP835	30453655
4,70	6	74	36	29	36	SCD121-0470-2-2-140HA05-HP835	30390968
4,80	6	82	44	35	36	SCD121-0480-2-2-140HA05-HP835	30390969
4,90	6	82	44	35	36	SCD121-0490-2-2-140HA05-HP835	30390970
5,00	6	82	44	35	36	SCD121-0500-2-2-140HA05-HP835	30390971
5,10	6	82	44	35	36	SCD121-0510-2-2-140HA05-HP835	30390972
5,20	6	82	44	35	36	SCD121-0520-2-2-140HA05-HP835	30390973
5,30	6	82	44	35	36	SCD121-0530-2-2-140HA05-HP835	30390974
5,40	6	82	44	35	36	SCD121-0540-2-2-140HA05-HP835	30390975
5,50	6	82	44	35	36	SCD121-0550-2-2-140HA05-HP835	30390976
5,60	6	82	44	35	36	SCD121-0560-2-2-140HA05-HP835	30390977
5,70	6	82	44	35	36	SCD121-0570-2-2-140HA05-HP835	30390978

Continúa en la página siguiente.

MEGA-Drill-Inox | Broca helicoidal de metal duro SCD121 (5xD), suministro de refrigerante interior

Dimensiones						Forma del mango HA	
d ₁ m7	d ₂ h6	l ₁	l ₂	l ₃	l ₄	Especificación	Referencia
5,80	6	82	44	35	36	SCD121-0580-2-2-140HA05-HP835	30390979
5,90	6	82	44	35	36	SCD121-0590-2-2-140HA05-HP835	30390980
5,95	6	82	44	35	36	SCD121-0595-2-2-140HA05-HP835	30453657
6,00	6	82	44	35	36	SCD121-0600-2-2-140HA05-HP835	30390981
6,10	8	91	53	43	36	SCD121-0610-2-2-140HA05-HP835	30390982
6,20	8	91	53	43	36	SCD121-0620-2-2-140HA05-HP835	30390983
6,30	8	91	53	43	36	SCD121-0630-2-2-140HA05-HP835	30390984
6,40	8	91	53	43	36	SCD121-0640-2-2-140HA05-HP835	30390985
6,50	8	91	53	43	36	SCD121-0650-2-2-140HA05-HP835	30390986
6,60	8	91	53	43	36	SCD121-0660-2-2-140HA05-HP835	30390987
6,70	8	91	53	43	36	SCD121-0670-2-2-140HA05-HP835	30390988
6,80	8	91	53	43	36	SCD121-0680-2-2-140HA05-HP835	30390989
6,90	8	91	53	43	36	SCD121-0690-2-2-140HA05-HP835	30390990
7,00	8	91	53	43	36	SCD121-0700-2-2-140HA05-HP835	30390991
7,10	8	91	53	43	36	SCD121-0710-2-2-140HA05-HP835	30390992
7,20	8	91	53	43	36	SCD121-0720-2-2-140HA05-HP835	30390993
7,30	8	91	53	43	36	SCD121-0730-2-2-140HA05-HP835	30390994
7,40	8	91	53	43	36	SCD121-0740-2-2-140HA05-HP835	30390995
7,45*	8	91	53	43	36	SCD121-0745-2-2-140HA05-HP835	30453658
7,50	8	91	53	43	36	SCD121-0750-2-2-140HA05-HP835	30390996
7,60	8	91	53	43	36	SCD121-0760-2-2-140HA05-HP835	30390997
7,70	8	91	53	43	36	SCD121-0770-2-2-140HA05-HP835	30390998
7,80	8	91	53	43	36	SCD121-0780-2-2-140HA05-HP835	30390999
8,00	8	91	53	43	36	SCD121-0800-2-2-140HA05-HP835	30391001
8,10	10	103	61	49	40	SCD121-0810-2-2-140HA05-HP835	30391002
8,20	10	103	61	49	40	SCD121-0820-2-2-140HA05-HP835	30391003
8,30	10	103	61	49	40	SCD121-0830-2-2-140HA05-HP835	30391004
8,50	10	103	61	49	40	SCD121-0850-2-2-140HA05-HP835	30391006
8,60	10	103	61	49	40	SCD121-0860-2-2-140HA05-HP835	30391007
8,70	10	103	61	49	40	SCD121-0870-2-2-140HA05-HP835	30391008
8,80	10	103	61	49	40	SCD121-0880-2-2-140HA05-HP835	30391009
8,90	10	103	61	49	40	SCD121-0890-2-2-140HA05-HP835	30391010
9,00	10	103	61	49	40	SCD121-0900-2-2-140HA05-HP835	30391011
9,10	10	103	61	49	40	SCD121-0910-2-2-140HA05-HP835	30391012
9,35	10	103	61	49	40	SCD121-0935-2-2-140HA05-HP835	30450706
9,40	10	103	61	49	40	SCD121-0940-2-2-140HA05-HP835	30391015
9,45	10	103	61	49	40	SCD121-0945-2-2-140HA05-HP835	30453660
9,50	10	103	61	49	40	SCD121-0950-2-2-140HA05-HP835	30391016
9,80	10	103	61	49	40	SCD121-0980-2-2-140HA05-HP835	30391019
9,90	10	103	61	49	40	SCD121-0990-2-2-140HA05-HP835	30391020
10,00	10	103	61	49	40	SCD121-1000-2-2-140HA05-HP835	30391021
10,20	12	118	71	56	45	SCD121-1020-2-2-140HA05-HP835	30391023
10,30	12	118	71	56	45	SCD121-1030-2-2-140HA05-HP835	30391024
10,50	12	118	71	56	45	SCD121-1050-2-2-140HA05-HP835	30391026
10,55	12	118	71	56	45	SCD121-1055-2-2-140HA05-HP835	30453661
10,80	12	118	71	56	45	SCD121-1080-2-2-140HA05-HP835	30391029
11,00	12	118	71	56	45	SCD121-1100-2-2-140HA05-HP835	30391031
11,20*	12	118	71	56	45	SCD121-1120-2-2-140HA05-HP835	30391033
11,25	12	118	71	56	45	SCD121-1125-2-2-140HA05-HP835	30453662
11,30	12	118	71	56	45	SCD121-1130-2-2-140HA05-HP835	30391034
11,50	12	118	71	56	45	SCD121-1150-2-2-140HA05-HP835	30391036
11,70	12	118	71	56	45	SCD121-1170-2-2-140HA05-HP835	30391038
11,80	12	118	71	56	45	SCD121-1180-2-2-140HA05-HP835	30391039
12,00	12	118	71	56	45	SCD121-1200-2-2-140HA05-HP835	30391041
12,50	14	124	77	60	45	SCD121-1250-2-2-140HA05-HP835	30391042
13,00	14	124	77	60	45	SCD121-1300-2-2-140HA05-HP835	30391044
13,50	14	124	77	60	45	SCD121-1350-2-2-140HA05-HP835	30391045

MEGA-Drill-Inox | Broca helicoidal de metal duro SCD121 (5xD), suministro de refrigerante interior

Dimensiones						Forma del mango HA	
d ₁ m7	d ₂ h6	l ₁	l ₂	l ₃	l ₄	Especificación	Referencia
13,80	14	124	77	60	45	SCD121-1380-2-2-140HA05-HP835	30391046
14,00	14	124	77	60	45	SCD121-1400-2-2-140HA05-HP835	30391047
15,00	16	133	83	63	48	SCD121-1500-2-2-140HA05-HP835	30391050
16,00	16	133	83	63	48	SCD121-1600-2-2-140HA05-HP835	30391053
16,50	18	143	93	71	48	SCD121-1650-2-2-140HA05-HP835	30391054
17,00	18	143	93	71	48	SCD121-1700-2-2-140HA05-HP835	30391056
18,00	18	143	93	71	48	SCD121-1800-2-2-140HA05-HP835	30391059
20,00	20	153	101	77	50	SCD121-2000-2-2-140HA05-HP835	30391065

Características configurables

**Diámetro:**

Diámetro seleccionable libremente en incrementos de 0,01 mm

**Forma del mango:**

Forma del mango: HB | HE

Especificación

SCD121-[diámetro]-2-2-140[forma del mango]05-HP835

Dimensiones de la serie configurable

d ₁ min.	d ₁ max.	d ₂ h6	l ₁	l ₂	l ₃	l ₄
3,71	4,70	6	74	36	29	36
4,71	6,00	6	82	44	35	36
6,01	8,00	8	91	53	43	36
8,01	10,00	10	103	61	49	40
10,01	12,00	12	118	71	56	45
12,01	14,00	14	124	77	60	45
14,01	16,00	16	133	83	63	45
16,01	18,00	18	143	93	71	48
18,01	20,00	20	153	101	77	50

Ejemplo:

SCD121-0431-2-2-140HE05-HP835

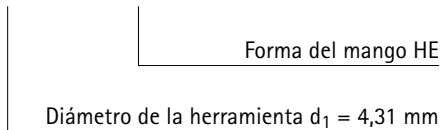

Medidas en mm.

* Especialmente indicada para la prefabricación de los agujeros para rosca para machos de laminación.

Para la recomendación de valores de corte, véase al final del capítulo.

Ejecuciones especiales y otros recubrimientos a petición.

MEGA-Drill-Inox

Broca helicoidal de metal duro
SCD121 (8xD), suministro de refrigerante interior

Ejecución:
 Diámetro de broca: 3,00 – 20,00 mm
 Tolerancia del agujero: ≥ IT 9
 Material de corte: HP835
 Número de insertos: 2
 Número de biseles guía: 2
 Ángulo de la punta: 140°
 Ángulo de hélice: 30°

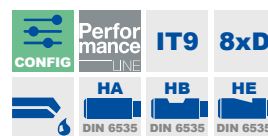
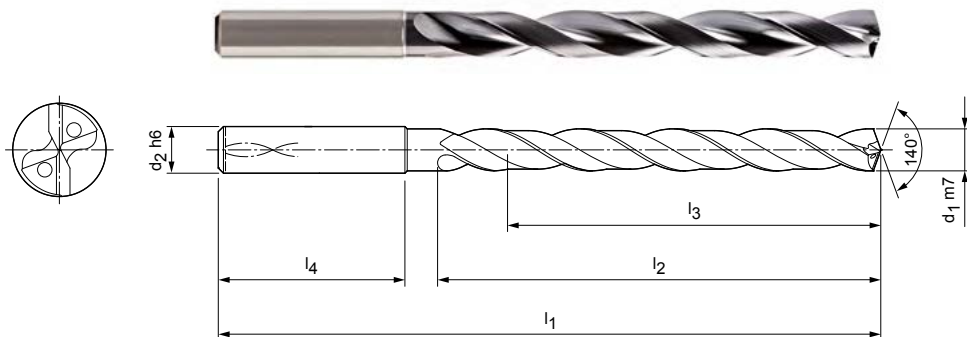

Serie preferente disponible en stock en forma de mango HA

Dimensiones						Forma del mango HA	
d ₁ m7	d ₂ h6	l ₁	l ₂	l ₃	l ₄	Especificación	Referencia
3,00	6	72	34	29	36	SCD121-0300-2-2-140HA08-HP835	30391171
3,20	6	72	34	29	36	SCD121-0320-2-2-140HA08-HP835	30391173
3,30	6	72	34	29	36	SCD121-0330-2-2-140HA08-HP835	30391174
3,40	6	72	34	29	36	SCD121-0340-2-2-140HA08-HP835	30391175
3,50	6	72	34	29	36	SCD121-0350-2-2-140HA08-HP835	30391176
3,70	6	72	34	29	36	SCD121-0370-2-2-140HA08-HP835	30391178
3,80	6	81	43	36	36	SCD121-0380-2-2-140HA08-HP835	30391179
3,90	6	81	43	36	36	SCD121-0390-2-2-140HA08-HP835	30391180
4,00	6	81	43	36	36	SCD121-0400-2-2-140HA08-HP835	30391181
4,20	6	81	43	36	36	SCD121-0420-2-2-140HA08-HP835	30391183
4,30	6	81	43	36	36	SCD121-0430-2-2-140HA08-HP835	30391184
4,40	6	81	43	36	36	SCD121-0440-2-2-140HA08-HP835	30391185
4,50	6	81	43	36	36	SCD121-0450-2-2-140HA08-HP835	30391186
4,80	6	95	57	48	36	SCD121-0480-2-2-140HA08-HP835	30391189
4,90	6	95	57	48	36	SCD121-0490-2-2-140HA08-HP835	30391190
5,00	6	95	57	48	36	SCD121-0500-2-2-140HA08-HP835	30391191
5,10	6	95	57	48	36	SCD121-0510-2-2-140HA08-HP835	30391192
5,30	6	95	57	48	36	SCD121-0530-2-2-140HA08-HP835	30391194
5,50	6	95	57	48	36	SCD121-0550-2-2-140HA08-HP835	30391196
5,60	6	95	57	48	36	SCD121-0560-2-2-140HA08-HP835	30391197
5,80	6	95	57	48	36	SCD121-0580-2-2-140HA08-HP835	30391199
5,90	6	95	57	48	36	SCD121-0590-2-2-140HA08-HP835	30391200
6,00	6	95	57	48	36	SCD121-0600-2-2-140HA08-HP835	30391201
6,10	8	114	76	64	36	SCD121-0610-2-2-140HA08-HP835	30391202
6,50	8	114	76	64	36	SCD121-0650-2-2-140HA08-HP835	30391206
6,60	8	114	76	64	36	SCD121-0660-2-2-140HA08-HP835	30391207
6,70	8	114	76	64	36	SCD121-0670-2-2-140HA08-HP835	30391208
6,80	8	114	76	64	36	SCD121-0680-2-2-140HA08-HP835	30391209
6,90	8	114	76	64	36	SCD121-0690-2-2-140HA08-HP835	30391210
7,00	8	114	76	64	36	SCD121-0700-2-2-140HA08-HP835	30391212
7,20	8	114	76	64	36	SCD121-0720-2-2-140HA08-HP835	30391214
7,50	8	114	76	64	36	SCD121-0750-2-2-140HA08-HP835	30391217
7,60	8	114	76	64	36	SCD121-0760-2-2-140HA08-HP835	30391218
7,80	8	114	76	64	36	SCD121-0780-2-2-140HA08-HP835	30391220
8,00	8	114	76	64	36	SCD121-0800-2-2-140HA08-HP835	30391222

MEGA-Drill-Inox | Broca helicoidal de metal duro SCD121 (8xD), suministro de refrigerante interior

Dimensiones						Forma del mango HA	
d ₁ m7	d ₂ h6	l ₁	l ₂	l ₃	l ₄	Especificación	Referencia
8,50	10	142	95	80	40	SCD121-0850-2-2-140HA08-HP835	30391227
8,90	10	142	95	80	40	SCD121-0890-2-2-140HA08-HP835	30391231
9,00	10	142	95	80	40	SCD121-0900-2-2-140HA08-HP835	30391232
9,10	10	142	95	80	40	SCD121-0910-2-2-140HA08-HP835	30391233
9,30	10	142	95	80	40	SCD121-0930-2-2-140HA08-HP835	30391235
9,50	10	142	95	80	40	SCD121-0950-2-2-140HA08-HP835	30391237
9,60	10	142	95	80	40	SCD121-0960-2-2-140HA08-HP835	30391238
9,70	10	142	95	80	40	SCD121-0970-2-2-140HA08-HP835	30391239
9,80	10	142	95	80	40	SCD121-0980-2-2-140HA08-HP835	30391240
10,00	10	142	95	80	40	SCD121-1000-2-2-140HA08-HP835	30391242
10,10	12	162	114	96	45	SCD121-1010-2-2-140HA08-HP835	30391243
10,20	12	162	114	96	45	SCD121-1020-2-2-140HA08-HP835	30391244
10,80	12	162	114	96	45	SCD121-1080-2-2-140HA08-HP835	30391250
11,00	12	162	114	96	45	SCD121-1100-2-2-140HA08-HP835	30391252
11,50	12	162	114	96	45	SCD121-1150-2-2-140HA08-HP835	30391257
11,80	12	162	114	96	45	SCD121-1180-2-2-140HA08-HP835	30391260
12,00	12	162	114	96	45	SCD121-1200-2-2-140HA08-HP835	30391262
13,00	14	178	133	112	45	SCD121-1300-2-2-140HA08-HP835	30391265
13,50	14	178	133	112	45	SCD121-1350-2-2-140HA08-HP835	30391266
14,00	14	178	133	112	45	SCD121-1400-2-2-140HA08-HP835	30391268
14,50	16	203	152	128	48	SCD121-1450-2-2-140HA08-HP835	30391269
15,00	16	203	152	128	48	SCD121-1500-2-2-140HA08-HP835	30391271
18,00	18	222	171	144	48	SCD121-1800-2-2-140HA08-HP835	30391280

Características configurables

**Diámetro:**

Diámetro seleccionable libremente en incrementos de 0,01 mm

**Forma del mango:**

Forma del mango: HB | HE

Especificación

SCD121-[diámetro]-2-2-140[forma del mango]08-HP835

Dimensiones de la serie configurable

d ₁ min.	d ₁ max.	d ₂ h6	l ₁	l ₂	l ₃	l ₄
3,71	4,70	6	81	43	36	36
4,71	6,00	6	95	57	48	36
6,01	8,00	8	114	76	64	36
8,01	10,00	10	142	95	80	40
10,01	12,00	12	162	114	96	45
12,01	14,00	14	178	133	112	45
14,01	16,00	16	203	152	128	48
16,01	18,00	18	222	171	144	48
18,01	20,00	20	243	190	160	50
16,01	18,00	18	123	73	51	48
18,01	20,00	20	131	79	55	50

Ejemplo:

SCD121-0431-2-2-140HE08-HP835

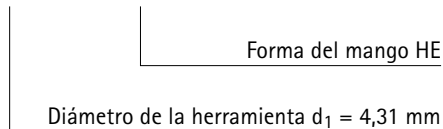

Medidas en mm.

Para la recomendación de valores de corte, véase al final del capítulo.

Ejecuciones especiales y otros recubrimientos a petición.

MEGA-Speed-Drill-Inox

Broca helicoidal de metal duro

SCD411 (5xD), suministro de refrigerante interior

Ejecución:

Diámetro de broca:	3,00 – 20,00 mm
Tolerancia del agujero:	≥ IT 9
Material de corte:	HP374
Número de insertos:	2
Número de biseles guía:	3
Ángulo de la punta:	135°
Ángulo de hélice:	30°

Aplicación:

Para el mecanizado a alta velocidad.

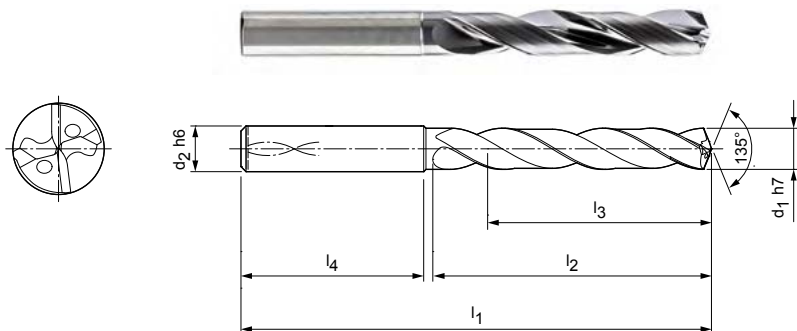

Serie preferente disponible en stock en forma de mango HA

Dimensiones						Forma del mango HA	
d ₁ h7	d ₂ h6	l ₁	l ₂	l ₃	l ₄	Especificación	Referencia
3,00	6	66	28	23	36	SCD411-0300-2-3-135HA05-HP374	30488182
3,10	6	66	28	23	36	SCD411-0310-2-3-135HA05-HP374	30488183
3,20	6	66	28	23	36	SCD411-0320-2-3-135HA05-HP374	30488184
3,30	6	66	28	23	36	SCD411-0330-2-3-135HA05-HP374	30488185
3,40	6	66	28	23	36	SCD411-0340-2-3-135HA05-HP374	30488186
3,50	6	66	28	23	36	SCD411-0350-2-3-135HA05-HP374	30488187
3,70	6	66	28	23	36	SCD411-0370-2-3-135HA05-HP374	30488189
3,80	6	74	36	29	36	SCD411-0380-2-3-135HA05-HP374	30488190
4,00	6	74	36	29	36	SCD411-0400-2-3-135HA05-HP374	30488192
4,10	6	74	36	29	36	SCD411-0410-2-3-135HA05-HP374	30488193
4,20	6	74	36	29	36	SCD411-0420-2-3-135HA05-HP374	30488194
4,30	6	74	36	29	36	SCD411-0430-2-3-135HA05-HP374	30488195
4,50	6	74	36	29	36	SCD411-0450-2-3-135HA05-HP374	30488197
4,65	6	74	36	29	36	SCD411-0465-2-3-135HA05-HP374	30488199
4,70	6	74	36	29	36	SCD411-0470-2-3-135HA05-HP374	30488200
4,80	6	82	44	35	36	SCD411-0480-2-3-135HA05-HP374	30488201
5,00	6	82	44	35	36	SCD411-0500-2-3-135HA05-HP374	30488203
5,10	6	82	44	35	36	SCD411-0510-2-3-135HA05-HP374	30488204
5,20	6	82	44	35	36	SCD411-0520-2-3-135HA05-HP374	30488205
5,30	6	82	44	35	36	SCD411-0530-2-3-135HA05-HP374	30488206
5,50	6	82	44	35	36	SCD411-0550-2-3-135HA05-HP374	30488208
5,55	6	82	44	35	36	SCD411-0555-2-3-135HA05-HP374	30488209
5,60	6	82	44	35	36	SCD411-0560-2-3-135HA05-HP374	30488210
5,80	6	82	44	35	36	SCD411-0580-2-3-135HA05-HP374	30488212
5,90	6	82	44	35	36	SCD411-0590-2-3-135HA05-HP374	30488213
6,00	6	82	44	35	36	SCD411-0600-2-3-135HA05-HP374	30488214
6,10	8	91	53	43	36	SCD411-0610-2-3-135HA05-HP374	30488215
6,30	8	91	53	43	36	SCD411-0630-2-3-135HA05-HP374	30488217
6,50	8	91	53	43	36	SCD411-0650-2-3-135HA05-HP374	30488219
6,60	8	91	53	43	36	SCD411-0660-2-3-135HA05-HP374	30488220
6,80	8	91	53	43	36	SCD411-0680-2-3-135HA05-HP374	30488222
6,90	8	91	53	43	36	SCD411-0690-2-3-135HA05-HP374	30488223
7,00	8	91	53	43	36	SCD411-0700-2-3-135HA05-HP374	30488224
7,30	8	91	53	43	36	SCD411-0730-2-3-135HA05-HP374	30488227
7,40	8	91	53	43	36	SCD411-0740-2-3-135HA05-HP374	30488228

MEGA-Speed-Drill-Inox | Broca helicoidal de metal duro SCD411 (5xD), suministro de refrigerante interior

Dimensiones						Forma del mango HA	
d ₁ h7	d ₂ h6	l ₁	l ₂	l ₃	l ₄	Especificación	Referencia
7,50	8	91	53	43	36	SCD411-0750-2-3-135HA05-HP374	30488229
7,60	8	91	53	43	36	SCD411-0760-2-3-135HA05-HP374	30488230
7,80	8	91	53	43	36	SCD411-0780-2-3-135HA05-HP374	30488232
8,00	8	91	53	43	36	SCD411-0800-2-3-135HA05-HP374	30488234
8,30	10	103	61	49	40	SCD411-0830-2-3-135HA05-HP374	30488237
8,50	10	103	61	49	40	SCD411-0850-2-3-135HA05-HP374	30488239
8,60	10	103	61	49	40	SCD411-0860-2-3-135HA05-HP374	30488240
8,70	10	103	61	49	40	SCD411-0870-2-3-135HA05-HP374	30488241
8,80	10	103	61	49	40	SCD411-0880-2-3-135HA05-HP374	30488242
8,90	10	103	61	49	40	SCD411-0890-2-3-135HA05-HP374	30488243
9,00	10	103	61	49	40	SCD411-0900-2-3-135HA05-HP374	30488244
9,20	10	103	61	49	40	SCD411-0920-2-3-135HA05-HP374	30488246
9,50	10	103	61	49	40	SCD411-0950-2-3-135HA05-HP374	30488249
9,70	10	103	61	49	40	SCD411-0970-2-3-135HA05-HP374	30488251
9,80	10	103	61	49	40	SCD411-0980-2-3-135HA05-HP374	30488252
9,90	10	103	61	49	40	SCD411-0990-2-3-135HA05-HP374	30488253
10,00	10	103	61	49	40	SCD411-1000-2-3-135HA05-HP374	30488254
10,20	12	118	71	56	45	SCD411-1020-2-3-135HA05-HP374	30488256
10,30	12	118	71	56	45	SCD411-1030-2-3-135HA05-HP374	30488257
10,50	12	118	71	56	45	SCD411-1050-2-3-135HA05-HP374	30488259
10,80	12	118	71	56	45	SCD411-1080-2-3-135HA05-HP374	30488262
11,00	12	118	71	56	45	SCD411-1100-2-3-135HA05-HP374	30488264
11,50	12	118	71	56	45	SCD411-1150-2-3-135HA05-HP374	30488269
11,80	12	118	71	56	45	SCD411-1180-2-3-135HA05-HP374	30488272
12,00	12	118	71	56	45	SCD411-1200-2-3-135HA05-HP374	30488274
12,20	14	124	77	60	45	SCD411-1220-2-3-135HA05-HP374	31307527
12,50	14	124	77	60	45	SCD411-1250-2-3-135HA05-HP374	30488275
12,80	14	124	77	60	45	SCD411-1280-2-3-135HA05-HP374	30488276
13,00	14	124	77	60	45	SCD411-1300-2-3-135HA05-HP374	30488277
13,50	14	124	77	60	45	SCD411-1350-2-3-135HA05-HP374	30488278
14,00	14	124	77	60	45	SCD411-1400-2-3-135HA05-HP374	30488280
14,20	16	133	83	63	48	SCD411-1420-2-3-135HA05-HP374	30661538
14,50	16	133	83	71	48	SCD411-1450-2-3-135HA05-HP374	30488281
15,00	16	133	83	71	48	SCD411-1500-2-3-135HA05-HP374	30488283
16,00	16	133	83	71	48	SCD411-1600-2-3-135HA05-HP374	30488286
17,00	18	143	93	71	48	SCD411-1700-2-3-135HA05-HP374	30488289
17,50	18	143	93	71	48	SCD411-1750-2-3-135HA05-HP374	30488290
18,00	18	143	93	71	48	SCD411-1800-2-3-135HA05-HP374	30488292
18,50	20	153	101	77	50	SCD411-1850-2-3-135HA05-HP374	30488293
20,00	20	153	101	77	50	SCD411-2000-2-3-135HA05-HP374	30488298

Continúa en la página siguiente.

MEGA-Speed-Drill-Inox | Broca helicoidal de metal duro SCD411 (5xD), suministro de refrigerante interior

Características configurables

**Diámetro:**

Diámetro seleccionable libremente en incrementos de 0,01 mm

**Forma del mango:**

Forma del mango: HB | HE

Especificación

SCD411-[diámetro]-2-3-135[forma del mango]05-HP374

Dimensiones de la serie configurable

d ₁ min.	d ₁ max.	d ₂ h6	l ₁	l ₂	l ₃	l ₄
3,00	3,70	6	66	28	23	36
3,71	4,70	6	74	36	29	36
4,71	6,00	6	82	44	35	36
6,01	8,00	8	91	53	43	36
8,01	10,00	10	103	61	49	40
10,01	12,00	12	118	71	56	45
12,01	14,00	14	124	77	60	45
14,01	16,00	16	133	83	63	48
16,01	18,00	18	143	93	71	48
18,01	20,00	20	153	101	77	50

Ejemplo:

SCD411-0431-2-3-140HE05-HP374

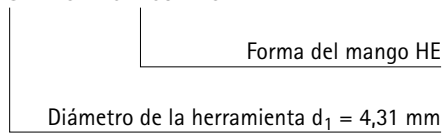

MEGA-Speed-Drill-Inox

Broca helicoidal de metal duro

SCD411 (8xD), suministro de refrigerante interior

Ejecución:

Diámetro de broca: 3,00 – 20,00 mm
 Tolerancia del agujero: \geq IT 9
 Material de corte: HP374
 Número de insertos: 2
 Número de biseles guía: 3
 Ángulo de la punta: 135°
 Ángulo de hélice: 30°

Aplicación:

Para el mecanizado de alta velocidad.

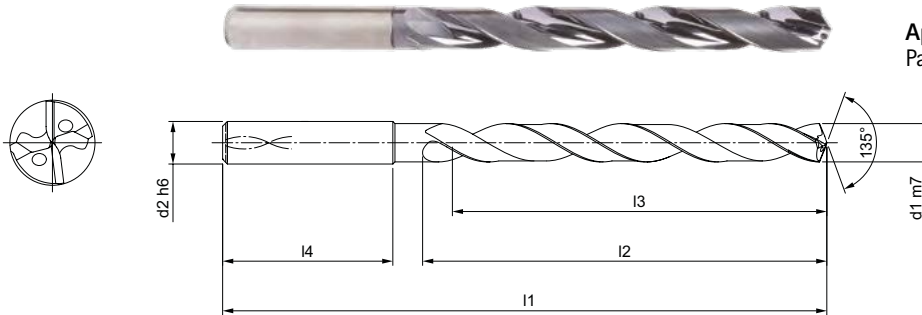

Serie preferente disponible en stock en forma de mango HA

Dimensiones						Forma del mango HA	
d ₁ m7	d ₂ h6	l ₁	l ₂	l ₃	l ₄	Especificación	Referencia
3,00	6	72	34	29	36	SCD411-0300-2-3-135HA08-HP374	31159372
3,20	6	72	34	29	36	SCD411-0320-2-3-135HA08-HP374	31159374
3,30	6	72	34	29	36	SCD411-0330-2-3-135HA08-HP374	31159375
3,40	6	72	34	29	36	SCD411-0340-2-3-135HA08-HP374	31159376
3,50	6	72	34	29	36	SCD411-0350-2-3-135HA08-HP374	31159377
3,70	6	72	34	29	36	SCD411-0370-2-3-135HA08-HP374	31159379
3,90	6	81	43	36	36	SCD411-0390-2-3-135HA08-HP374	31159391
4,00	6	81	43	36	36	SCD411-0400-2-3-135HA08-HP374	31159392
4,10	6	81	43	36	36	SCD411-0410-2-3-135HA08-HP374	31159393
4,20	6	81	43	36	36	SCD411-0420-2-3-135HA08-HP374	31159394
4,30	6	81	43	36	36	SCD411-0430-2-3-135HA08-HP374	31159395
4,50	6	81	43	36	36	SCD411-0450-2-3-135HA08-HP374	31159397
4,60	6	81	43	36	36	SCD411-0460-2-3-135HA08-HP374	31159398
4,80	6	95	57	48	36	SCD411-0480-2-3-135HA08-HP374	31159401
5,00	6	95	57	48	36	SCD411-0500-2-3-135HA08-HP374	31159403
5,10	6	95	57	48	36	SCD411-0510-2-3-135HA08-HP374	31159404
5,20	6	95	57	48	36	SCD411-0520-2-3-135HA08-HP374	31159405
5,40	6	95	57	48	36	SCD411-0540-2-3-135HA08-HP374	31159407
5,50	6	95	57	48	36	SCD411-0550-2-3-135HA08-HP374	31159408
5,80	6	95	57	48	36	SCD411-0580-2-3-135HA08-HP374	31159412
6,00	6	95	57	48	36	SCD411-0600-2-3-135HA08-HP374	31159414
6,10	8	114	76	64	36	SCD411-0610-2-3-135HA08-HP374	31159415
6,50	8	114	76	64	36	SCD411-0650-2-3-135HA08-HP374	31159419
6,80	8	114	76	64	36	SCD411-0680-2-3-135HA08-HP374	31159422
7,00	8	114	76	64	36	SCD411-0700-2-3-135HA08-HP374	31159424
7,50	8	114	76	64	36	SCD411-0750-2-3-135HA08-HP374	31159429
7,80	8	114	76	64	36	SCD411-0780-2-3-135HA08-HP374	31159432
8,00	8	114	76	64	36	SCD411-0800-2-3-135HA08-HP374	31159434
8,50	10	142	95	80	40	SCD411-0850-2-3-135HA08-HP374	31159439
9,00	10	142	95	80	40	SCD411-0900-2-3-135HA08-HP374	31159444
9,30	10	142	95	80	40	SCD411-0930-2-3-135HA08-HP374	31159447
9,50	10	142	95	80	40	SCD411-0950-2-3-135HA08-HP374	31159449
9,80	10	142	95	80	40	SCD411-0980-2-3-135HA08-HP374	31159452
10,00	10	142	95	80	40	SCD411-1000-2-3-135HA08-HP374	31159454
10,20	12	162	114	96	45	SCD411-1020-2-3-135HA08-HP374	31159456

Continúa en la página siguiente.

MEGA-Speed-Drill-Inox | Broca helicoidal de metal duro SCD411 (8xD), suministro de refrigerante interior

Dimensiones						Forma del mango HA	
d ₁ m7	d ₂ h6	l ₁	l ₂	l ₃	l ₄	Especificación	Referencia
10,50	12	162	114	96	45	SCD411-1050-2-3-135HA08-HP374	31159459
11,00	12	162	114	96	45	SCD411-1100-2-3-135HA08-HP374	31159464
11,80	12	162	114	96	45	SCD411-1180-2-3-135HA08-HP374	31159472
12,00	12	162	114	96	45	SCD411-1200-2-3-135HA08-HP374	31159474
12,50	14	178	133	112	45	SCD411-1250-2-3-135HA08-HP374	31159476
13,00	14	178	133	112	45	SCD411-1300-2-3-135HA08-HP374	31159478
13,50	14	178	133	112	45	SCD411-1350-2-3-135HA08-HP374	31159479
14,00	14	178	133	112	45	SCD411-1400-2-3-135HA08-HP374	31159481
15,00	16	203	152	128	48	SCD411-1500-2-3-135HA08-HP374	31159485
16,00	16	203	152	128	48	SCD411-1600-2-3-135HA08-HP374	31159489

Características configurables

**Diámetro:**

Diámetro seleccionable libremente en incrementos de 0,01 mm

**Forma del mango:**

Forma del mango: HB | HE

Especificación

SCD411-[diámetro]-2-3-135[forma del mango]08-HP374

Dimensiones de la serie configurable

d ₁ min.	d ₁ max.	d ₂ h6	l ₁	l ₂	l ₃	l ₄
3,00	3,70	6	72	34	29	36
3,71	4,70	6	81	43	36	36
4,71	6,00	6	95	57	48	36
6,01	8,00	8	114	76	64	36
8,01	10,00	10	142	95	80	40
10,01	12,00	12	162	114	96	45
12,01	14,00	14	178	133	112	45
14,01	16,00	16	203	152	128	48
16,01	18,00	18	222	171	144	48
18,01	20,00	20	243	190	160	50

Ejemplo:

SCD411-0431-2-3-140HE08-HP374

Forma del mango HE

Diámetro de la herramienta d₁ = 4,31 mm

Medidas en mm.

Para la recomendación de valores de corte, véase al final del capítulo.

Ejecuciones especiales y otros recubrimientos a petición.

MEGA-Speed-Drill-Inox

Broca helicoidal de metal duro

SCD411 (12xD), suministro de refrigerante interior

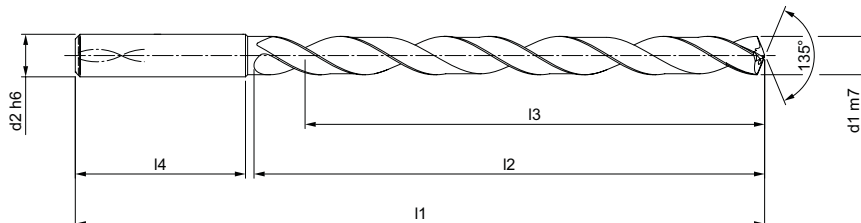
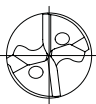

Ejecución:

- Diámetro de broca: 3,00 – 20,00 mm
- Tolerancia del agujero: ≥ IT 9
- Material de corte: HP374
- Número de insertos: 2
- Número de biseles guía: 3
- Ángulo de la punta: 135°
- Ángulo de hélice: 30°

Aplicación:

Para el mecanizado de alta velocidad.



Serie preferente disponible en stock en forma de mango HA

Dimensiones						Forma del mango HA	
d ₁ m7	d ₂ h6	l ₁	l ₂	l ₃	l ₄	Especificación	Referencia
3,00	6	92	54	48	36	SCD411-0300-2-3-135HA12-HP374	31132678
3,10	6	92	54	48	36	SCD411-0310-2-3-135HA12-HP374	31132679
3,20	6	92	54	48	36	SCD411-0320-2-3-135HA12-HP374	31132690
3,30	6	92	54	48	36	SCD411-0330-2-3-135HA12-HP374	31132691
3,40	6	92	54	48	36	SCD411-0340-2-3-135HA12-HP374	31132692
3,50	6	92	54	48	36	SCD411-0350-2-3-135HA12-HP374	31132693
3,70	6	92	54	48	36	SCD411-0370-2-3-135HA12-HP374	31132695
4,00	6	102	64	58	36	SCD411-0400-2-3-135HA12-HP374	31132698
4,10	6	102	64	58	36	SCD411-0410-2-3-135HA12-HP374	31132699
4,20	6	102	64	58	36	SCD411-0420-2-3-135HA12-HP374	31132700
4,30	6	102	64	58	36	SCD411-0430-2-3-135HA12-HP374	31132701
4,50	6	102	64	58	36	SCD411-0450-2-3-135HA12-HP374	31132703
4,80	6	116	78	70	36	SCD411-0480-2-3-135HA12-HP374	31132706
5,00	6	116	78	70	36	SCD411-0500-2-3-135HA12-HP374	31132708
5,10	6	116	78	70	36	SCD411-0510-2-3-135HA12-HP374	31132709
5,20	6	116	78	70	36	SCD411-0520-2-3-135HA12-HP374	31132710
5,40	6	116	78	70	36	SCD411-0540-2-3-135HA12-HP374	31132712
5,50	6	116	78	70	36	SCD411-0550-2-3-135HA12-HP374	31132713
5,80	6	116	78	70	36	SCD411-0580-2-3-135HA12-HP374	31132716
6,00	6	116	78	70	36	SCD411-0600-2-3-135HA12-HP374	31132718
6,10	8	146	108	94	36	SCD411-0610-2-3-135HA12-HP374	31132719
6,20	8	146	108	94	36	SCD411-0620-2-3-135HA12-HP374	31132720
6,50	8	146	108	94	36	SCD411-0650-2-3-135HA12-HP374	31132723
6,80	8	146	108	94	36	SCD411-0680-2-3-135HA12-HP374	31132726
7,00	8	146	108	94	36	SCD411-0700-2-3-135HA12-HP374	31132728
7,50	8	146	108	94	36	SCD411-0750-2-3-135HA12-HP374	31132733
7,80	8	146	108	94	36	SCD411-0780-2-3-135HA12-HP374	31132736
8,00	8	146	108	94	36	SCD411-0800-2-3-135HA12-HP374	31132738
8,50	10	162	120	110	40	SCD411-0850-2-3-135HA12-HP374	31132743
9,00	10	162	120	110	40	SCD411-0900-2-3-135HA12-HP374	31132748
9,10	10	162	120	110	40	SCD411-0910-2-3-135HA12-HP374	31132749
9,50	10	162	120	110	40	SCD411-0950-2-3-135HA12-HP374	31132753
9,70	10	162	120	110	40	SCD411-0970-2-3-135HA12-HP374	31132755
9,80	10	162	120	110	40	SCD411-0980-2-3-135HA12-HP374	31132756
10,00	10	162	120	110	40	SCD411-1000-2-3-135HA12-HP374	31132758

MEGA-Speed-Drill-Inox | Broca helicoidal de metal duro SCD411 (12xD), suministro de refrigerante interior

Dimensiones						Forma del mango HA	
d ₁ m7	d ₂ h6	l ₁	l ₂	l ₃	l ₄	Especificación	Referencia
10,10	12	204	156	142	45	SCD411-1010-2-3-135HA12-HP374	31132759
10,20	12	204	156	142	45	SCD411-1020-2-3-135HA12-HP374	31132760
10,50	12	204	156	142	45	SCD411-1050-2-3-135HA12-HP374	31132763
11,00	12	204	156	142	45	SCD411-1100-2-3-135HA12-HP374	31132768
11,80	12	204	156	142	45	SCD411-1180-2-3-135HA12-HP374	31132776
12,00	12	204	156	142	45	SCD411-1200-2-3-135HA12-HP374	31132778
12,50	14	230	182	166	45	SCD411-1250-2-3-135HA12-HP374	31132780
12,80	14	230	182	166	45	SCD411-1280-2-3-135HA12-HP374	31132781
13,00	14	230	182	166	45	SCD411-1300-2-3-135HA12-HP374	31132782
13,50	14	230	182	166	45	SCD411-1350-2-3-135HA12-HP374	31132783
14,00	14	230	182	166	45	SCD411-1400-2-3-135HA12-HP374	31132785
15,00	16	260	208	192	48	SCD411-1500-2-3-135HA12-HP374	31132788
16,00	16	260	208	192	48	SCD411-1600-2-3-135HA12-HP374	31132793

Características configurables

**Diámetro:**

Diámetro seleccionable libremente en incrementos de 0,01 mm

**Forma del mango:**

Forma del mango: HB | HE

Especificación

SCD411-[diámetro]-2-3-135[forma del mango]12-HP374

Dimensiones de la serie configurable

d ₁ min.	d ₁ max.	d ₂ h6	l ₁	l ₂	l ₃	l ₄
3,00	3,70	6	92	54	48	36
3,71	4,70	6	102	64	58	36
4,71	6,00	6	116	78	70	36
6,01	8,00	8	146	108	94	36
8,01	10,00	10	162	120	110	40
10,01	12,00	12	204	156	142	45
12,01	14,00	14	230	182	166	45
14,01	16,00	16	260	208	192	48
16,01	18,00	18	285	234	216	48
18,01	20,00	20	310	258	240	50

Ejemplo:

SCD411-0431-2-3-140HE12-HP374

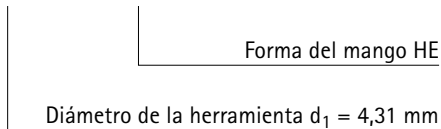

Medidas en mm.

Para la recomendación de valores de corte, véase al final del capítulo.

Ejecuciones especiales y otros recubrimientos a petición.

MEGA-Speed-Drill-Iron

Broca helicoidal de metal duro

SCD421 (5xD), suministro de refrigerante interior

Ejecución:

Diámetro de broca:	3,00 – 20,00 mm
Tolerancia del agujero:	≥ IT 9
Material de corte:	HP238
Número de insertos:	2
Número de bisel guía:	3
Ángulo de la punta:	130°
Ángulo de hélice:	30°

Aplicación:

Para el mecanizado a alta velocidad.

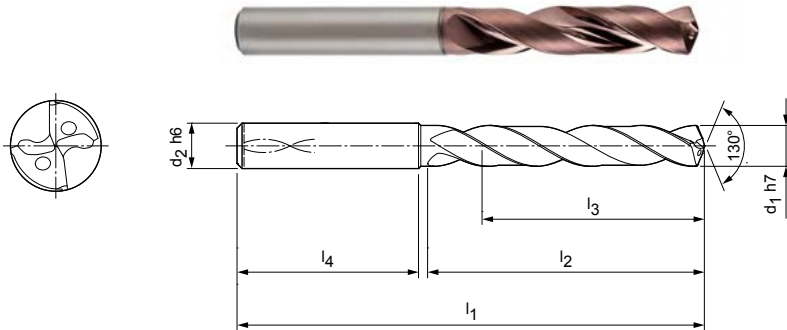

Serie preferente disponible en stock en forma de mango HA

Dimensiones						Forma del mango HA	
d ₁ h7	d ₂ h6	l ₁	l ₂	l ₃	l ₄	Especificación	Referencia
5,00	6	82	44	35	36	SCD421-0500-2-3-130HA05-HP238	30488320
5,10	6	82	44	35	36	SCD421-0510-2-3-130HA05-HP238	30488321
6,00	6	82	44	35	36	SCD421-0600-2-3-130HA05-HP238	30488331
6,90	8	91	53	43	36	SCD421-0690-2-3-130HA05-HP238	30488340
7,00	8	91	53	43	36	SCD421-0700-2-3-130HA05-HP238	30488341
7,20	8	91	53	43	36	SCD421-0720-2-3-130HA05-HP238	30488343
8,10	10	103	61	49	40	SCD421-0810-2-3-130HA05-HP238	30488352
8,50	10	103	61	49	40	SCD421-0850-2-3-130HA05-HP238	30488356
9,00	10	103	61	49	40	SCD421-0900-2-3-130HA05-HP238	30488361
14,00	14	124	77	60	45	SCD421-1400-2-3-130HA05-HP238	30488397
17,50	18	143	93	71	48	SCD421-1750-2-3-130HA05-HP238	30488407

Características configurables



Diámetro:

Diámetro seleccionable libremente en incrementos de 0,01 mm



Forma del mango:

Forma del mango: HB | HE

Especificación

SCD421-[diámetro]-2-3-130[forma del mango]05-HP238

Dimensiones de la serie configurable

d ₁ min.	d ₁ max.	d ₂ h6	l ₁	l ₂	l ₃	l ₄
3,00	3,70	6	66	28	23	36
3,71	4,79	6	74	36	29	36
4,80	6,00	6	82	44	35	36
6,01	8,00	8	91	53	43	36
8,01	10,00	10	103	61	49	40
10,01	12,00	12	118	71	56	45
12,01	14,00	14	124	77	60	45
14,01	16,00	16	133	83	63	48
16,01	18,00	18	143	93	71	48
18,01	20,00	20	153	101	77	50

Ejemplo:

SCD421-0431-2-3-130HE05-HP238

Forma del mango HE

Diámetro de la herramienta d₁ = 4,31 mm

Medidas en mm.

Para la recomendación de valores de corte, véase al final del capítulo.

Ejecuciones especiales y otros recubrimientos a petición.

MEGA-Drill-Alu

Broca helicoidal de metal duro
SCD131 (3xD), suministro de refrigerante interior

Ejecución:

Diámetro de broca: 3,00 – 20,00 mm
Tolerancia del agujero: \geq IT 9
Material de corte: HU630
Número de insertos: 2
Número de bisel guía: 2
Ángulo de la punta: 140°
Ángulo de hélice: 30°

Aplicación:

Adecuada como broca piloto para MEGA-Deep-Drill-Alu.

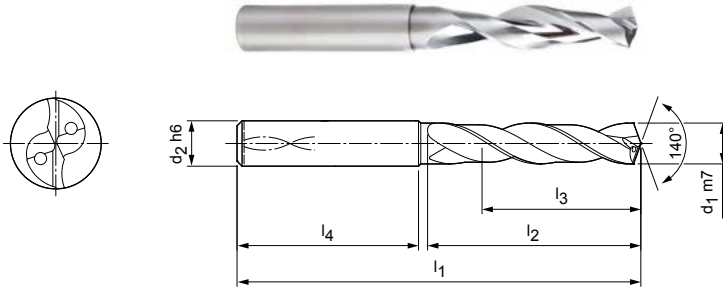

Serie preferente disponible en stock en forma de mango HA

Dimensiones						Forma del mango HA	
d ₁ m7	d ₂ h6	l ₁	l ₂	l ₃	l ₄	Especificación	Referencia
6,50	8	79	34	24	36	SCD131-0650-2-2-140HA03-HU630	30394280
6,70	8	79	34	24	36	SCD131-0670-2-2-140HA03-HU630	30446643
7,00	8	79	34	24	36	SCD131-0700-2-2-140HA03-HU630	30391294
10,00	10	89	47	35	40	SCD131-1000-2-2-140HA03-HU630	30391297
11,00	12	102	55	40	45	SCD131-1100-2-2-140HA03-HU630	30391298
12,00	12	102	55	40	45	SCD131-1200-2-2-140HA03-HU630	30391299
13,20	14	107	60	43	45	SCD131-1320-2-2-140HA03-HU630	30694326
13,70	14	107	60	43	45	SCD131-1370-2-2-140HA03-HU630	30694329
16,00	16	115	65	45	48	SCD131-1600-2-2-140HA03-HU630	30391303

Características configurables



Diámetro:

Diámetro seleccionable libremente en incrementos de 0,01 mm



Forma del mango:

Forma del mango: HB | HE

Especificación

SCD131-[diámetro]-2-2-140[forma del mango]03-HU630

Dimensiones de la serie configurable

d ₁ min.	d ₁ max.	d ₂ h6	l ₁	l ₂	l ₃	l ₄
3,00	3,50	6	62	20	14	36
3,51	4,50	6	66	24	17	36
4,51	6,00	6	66	28	20	36
6,01	7,97	8	79	34	24	36
7,98	8,00	8	79	41	29	36
8,01	10,00	10	89	47	35	40
10,01	12,00	12	102	55	40	45
12,01	14,00	14	107	60	43	45
14,01	16,00	16	115	65	45	48
16,01	18,00	18	123	73	51	48
18,01	20,00	20	131	79	55	50

Ejemplo:

SCD131-0431-2-3-140HE03-HU630

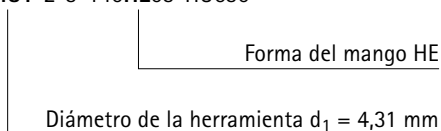

Medidas en mm.

Para la recomendación de valores de corte, véase al final del capítulo.

Ejecuciones especiales y otros recubrimientos a petición.

MEGA-Drill-Alu

Broca helicoidal de metal duro

SCD131 (5xD), suministro de refrigerante interior

Ejecución:

Diámetro de broca:	2,80 – 20,00 mm
Tolerancia del agujero:	≥ IT 9
Material de corte:	HU630
Número de insertos:	2
Número de biseles guía:	2
Ángulo de la punta:	140°
Ángulo de hélice:	30°

Aplicación:

Adecuada como broca piloto para MEGA-Deep-Drill-Alu.

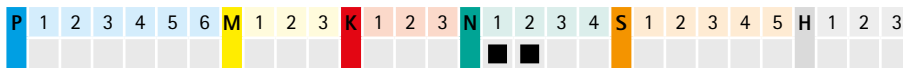
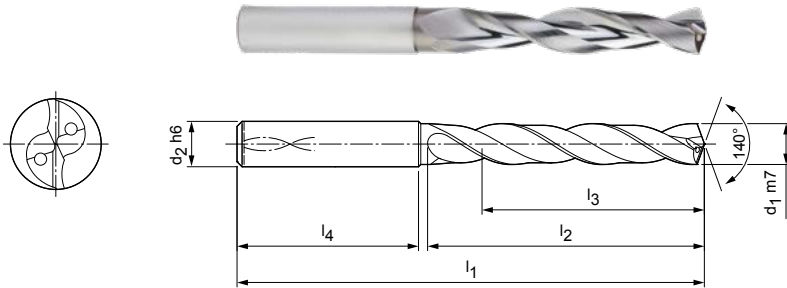

Serie preferente disponible en stock en forma de mango HA

Dimensiones						Forma del mango HA	
d ₁ m7	d ₂ h6	l ₁	l ₂	l ₃	l ₄	Especificación	Referencia
3,00	6	66	28	23	36	SCD131-0300-2-2-140HA05-HU630	30391326
3,20	6	66	28	23	36	SCD131-0320-2-2-140HA05-HU630	30391328
3,30	6	66	28	23	36	SCD131-0330-2-2-140HA05-HU630	30391329
3,50	6	66	28	23	36	SCD131-0350-2-2-140HA05-HU630	30391331
3,70*	6	66	28	23	36	SCD131-0370-2-2-140HA05-HU630	30391333
3,90	6	74	36	29	36	SCD131-0390-2-2-140HA05-HU630	30391335
4,00	6	74	36	29	36	SCD131-0400-2-2-140HA05-HU630	30391336
4,10	6	74	36	29	36	SCD131-0410-2-2-140HA05-HU630	30391337
4,20	6	74	36	29	36	SCD131-0420-2-2-140HA05-HU630	30391338
4,30	6	74	36	29	36	SCD131-0430-2-2-140HA05-HU630	30391339
4,50	6	74	36	29	36	SCD131-0450-2-2-140HA05-HU630	30391341
4,60	6	74	36	29	36	SCD131-0460-2-2-140HA05-HU630	30391342
4,70	6	74	36	29	36	SCD131-0470-2-2-140HA05-HU630	30391343
5,00	6	82	44	35	36	SCD131-0500-2-2-140HA05-HU630	30391346
5,10	6	82	44	35	36	SCD131-0510-2-2-140HA05-HU630	30391347
5,20	6	82	44	35	36	SCD131-0520-2-2-140HA05-HU630	30391348
5,50	6	82	44	35	36	SCD131-0550-2-2-140HA05-HU630	30391351
5,60	6	82	44	35	36	SCD131-0560-2-2-140HA05-HU630	30391352
6,00	6	82	44	35	36	SCD131-0600-2-2-140HA05-HU630	30391356
6,10	8	91	53	43	36	SCD131-0610-2-2-140HA05-HU630	30391357
6,20	8	91	53	43	36	SCD131-0620-2-2-140HA05-HU630	30391358
6,30	8	91	53	43	36	SCD131-0630-2-2-140HA05-HU630	30391359
6,40	8	91	53	43	36	SCD131-0640-2-2-140HA05-HU630	30391360
6,50	8	91	53	43	36	SCD131-0650-2-2-140HA05-HU630	30391361
6,60	8	91	53	43	36	SCD131-0660-2-2-140HA05-HU630	30391362
6,80	8	91	53	43	36	SCD131-0680-2-2-140HA05-HU630	30391364
7,00	8	91	53	43	36	SCD131-0700-2-2-140HA05-HU630	30391366
7,40	8	91	53	43	36	SCD131-0740-2-2-140HA05-HU630	30391370
7,50	8	91	53	43	36	SCD131-0750-2-2-140HA05-HU630	30391371
7,60	8	91	53	43	36	SCD131-0760-2-2-140HA05-HU630	30391372
8,00	8	91	53	43	36	SCD131-0800-2-2-140HA05-HU630	30391376
8,40	10	103	61	49	40	SCD131-0840-2-2-140HA05-HU630	30391380
8,50	10	103	61	49	40	SCD131-0850-2-2-140HA05-HU630	30391381
8,73	10	103	61	49	40	SCD131-0873-2-2-140HA05-HU630	30451167
8,90	10	103	61	49	40	SCD131-0890-2-2-140HA05-HU630	30391385

MEGA-Drill-Alu | Broca helicoidal de metal duro SCD131 (5xD), suministro de refrigerante interior

Dimensiones						Forma del mango HA	
d ₁ m7	d ₂ h6	l ₁	l ₂	l ₃	l ₄	Especificación	Referencia
9,00	10	103	61	49	40	SCD131-0900-2-2-140HA05-HU630	30391386
9,20	10	103	61	49	40	SCD131-0920-2-2-140HA05-HU630	30391388
9,30*	10	103	61	49	40	SCD131-0930-2-2-140HA05-HU630	30391389
9,50	10	103	61	49	40	SCD131-0950-2-2-140HA05-HU630	30391391
9,60	10	103	61	49	40	SCD131-0960-2-2-140HA05-HU630	30391392
10,00	10	103	61	49	40	SCD131-1000-2-2-140HA05-HU630	30391396
10,20	12	118	71	56	45	SCD131-1020-2-2-140HA05-HU630	30391398
10,50	12	118	71	56	45	SCD131-1050-2-2-140HA05-HU630	30391401
10,80	12	118	71	56	45	SCD131-1080-2-2-140HA05-HU630	30391404
11,00	12	118	71	56	45	SCD131-1100-2-2-140HA05-HU630	30391406
11,50	12	118	71	56	45	SCD131-1150-2-2-140HA05-HU630	30391407
12,00	12	118	71	56	45	SCD131-1200-2-2-140HA05-HU630	30391408
12,50	14	124	77	60	45	SCD131-1250-2-2-140HA05-HU630	30391409
13,50	14	124	77	60	45	SCD131-1350-2-2-140HA05-HU630	30391411
14,00	14	124	77	60	45	SCD131-1400-2-2-140HA05-HU630	30391412
16,00	16	133	83	63	48	SCD131-1600-2-2-140HA05-HU630	30391418
20,00	20	153	101	77	50	SCD131-2000-2-2-140HA05-HU630	30446886

Características configurables

**Diámetro:**

Diámetro seleccionable libremente en incrementos de 0,01 mm

**Forma del mango:**

Forma del mango: HB | HE

Especificación

SCD131-[diámetro]-2-2-140[forma del mango]05-HU630

Dimensiones de la serie configurable

d ₁ min.	d ₁ max.	d ₂ h6	l ₁	l ₂	l ₃	l ₄
2,80	3,70	6	66	28	23	36
3,71	4,70	6	74	36	29	36
4,71	6,00	6	82	44	35	36
6,01	8,00	8	91	53	43	36
8,01	10,00	10	103	61	49	40
10,01	12,00	12	118	71	56	45
12,01	14,00	14	124	77	60	45
14,01	16,00	16	133	83	63	48
16,01	18,00	18	143	93	71	48
18,01	20,00	20	153	101	77	50

Ejemplo:

SCD131-0431-2-2-140HE05-HU630

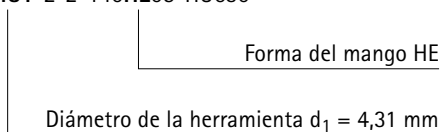

Medidas en mm.

* Especialmente indicada para la prefabricación de los agujeros para rosca para machos de laminación.

Para la recomendación de valores de corte, véase al final del capítulo.

Ejecuciones especiales y otros recubrimientos a petición.

MEGA-Drill-Alu

Broca helicoidal de metal duro

SCD131 (8xD), suministro de refrigerante interior

Ejecución:

Diámetro de broca: 3,00 – 20,00 mm

Tolerancia del agujero: \geq IT 9

Material de corte: HU630

Número de insertos: 2

Número de bisel guía: 2

Ángulo de la punta: 140°

Ángulo de hélice: 30°

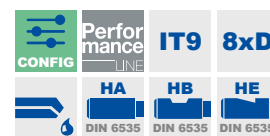
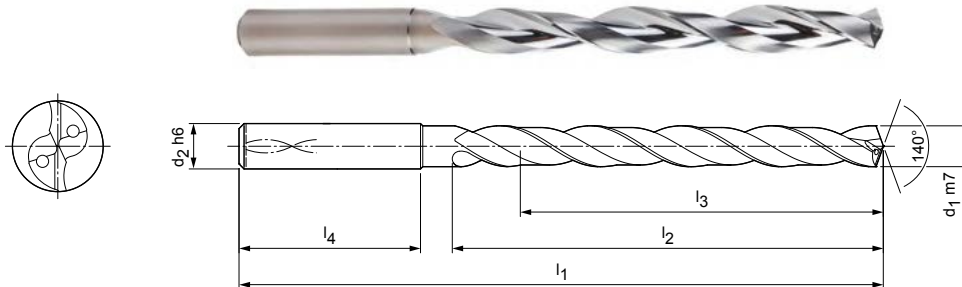

Serie preferente disponible en stock en forma de mango HA

Dimensiones						Forma del mango HA	
d ₁ m7	d ₂ h6	l ₁	l ₂	l ₃	l ₄	Especificación	Referencia
3,00	6	72	34	29	36	SCD131-0300-2-2-140HA08-HU630	30391421
3,30	6	72	34	29	36	SCD131-0330-2-2-140HA08-HU630	30391424
3,50	6	72	34	29	36	SCD131-0350-2-2-140HA08-HU630	30391426
3,70	6	72	34	29	36	SCD131-0370-2-2-140HA08-HU630	30391428
4,00	6	81	43	36	36	SCD131-0400-2-2-140HA08-HU630	30391431
4,50	6	81	43	36	36	SCD131-0450-2-2-140HA08-HU630	30391436
5,00	6	95	57	48	36	SCD131-0500-2-2-140HA08-HU630	30391441
5,50	6	95	57	48	36	SCD131-0550-2-2-140HA08-HU630	30391446
6,50	8	114	76	64	36	SCD131-0650-2-2-140HA08-HU630	30391457
6,80	8	114	76	64	36	SCD131-0680-2-2-140HA08-HU630	30391460
7,00	8	114	76	64	36	SCD131-0700-2-2-140HA08-HU630	30391462
8,00	8	114	76	64	36	SCD131-0800-2-2-140HA08-HU630	30391472
9,30	10	142	95	80	40	SCD131-0930-2-2-140HA08-HU630	30391484
11,00	12	162	114	96	45	SCD131-1100-2-2-140HA08-HU630	30391500
12,00	12	162	114	96	45	SCD131-1200-2-2-140HA08-HU630	30391510

Características configurables



Diámetro:

Diámetro seleccionable libremente en incrementos de 0,01 mm



Forma del mango:

Forma del mango: HB | HE

Especificación

SCD131-[diámetro]-2-2-140[forma del mango]08-HU630

Dimensiones de la serie configurable

d ₁ min.	d ₁ max.	d ₂ h6	l ₁	l ₂	l ₃	l ₄
3,00	3,70	6	72	34	29	36
3,71	4,70	6	81	43	36	36
4,71	6,00	6	95	57	48	36
6,01	8,00	8	114	76	64	36
8,01	10,00	10	142	95	80	40
10,01	12,00	12	162	114	96	45
12,01	14,00	14	178	133	112	45
14,01	16,00	16	203	152	128	48
16,01	18,00	18	222	171	144	48
18,01	20,00	20	243	190	160	50

Ejemplo:

SCD131-0431-2-2-140HE08-HU630

Forma del mango HE

Diámetro de la herramienta d₁ = 4,31 mm

Medidas en mm.

Para la recomendación de valores de corte, véase al final del capítulo.

Ejecuciones especiales y otros recubrimientos a petición.

MEGA-Drill-Alu

Broca helicoidal de metal duro
SCD131 (12xD), suministro de refrigerante interior

Ejecución:

Diámetro de broca: 3,00 – 20,00 mm
Tolerancia del agujero: \geq IT 9
Material de corte: HU630
Número de insertos: 2
Número de bisel guía: 2
Ángulo de la punta: 140°
Ángulo de hélice: 30°

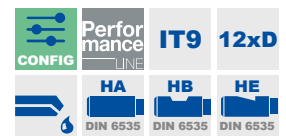
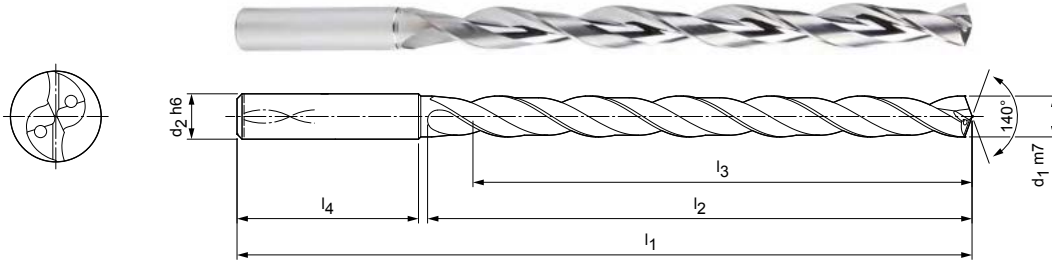

Serie preferente disponible en stock en forma de mango HA

Dimensiones						Forma del mango HA	
d ₁ m7	d ₂ h6	l ₁	l ₂	l ₃	l ₄	Especificación	Referencia
3,00	6	92	54	48	36	SCD131-0300-2-2-140HA12-HU630	30391519
3,50	6	92	54	48	36	SCD131-0350-2-2-140HA12-HU630	30391524
4,00	6	102	64	58	36	SCD131-0400-2-2-140HA12-HU630	30391529
4,70	6	102	64	58	36	SCD131-0470-2-2-140HA12-HU630	30391536
5,00	6	116	78	70	36	SCD131-0500-2-2-140HA12-HU630	30391539
5,40	6	116	78	70	36	SCD131-0540-2-2-140HA12-HU630	30391543
5,50	6	116	78	70	36	SCD131-0550-2-2-140HA12-HU630	30391544
5,60	6	116	78	70	36	SCD131-0560-2-2-140HA12-HU630	30391545
6,00	6	116	78	70	36	SCD131-0600-2-2-140HA12-HU630	30391549
6,50	8	146	108	94	36	SCD131-0650-2-2-140HA12-HU630	30391554
6,60	8	146	108	94	36	SCD131-0660-2-2-140HA12-HU630	30391555
7,00	8	146	108	94	36	SCD131-0700-2-2-140HA12-HU630	30391558
8,00	8	146	108	94	36	SCD131-0800-2-2-140HA12-HU630	30391568
9,00	10	162	120	110	40	SCD131-0900-2-2-140HA12-HU630	30391577

Características configurables



Diámetro:
Diámetro seleccionable libremente en incrementos de 0,01 mm



Forma del mango:
Forma del mango: HB | HE

Especificación

SCD131-[diámetro]-2-2-140[forma del mango]12-HU630

Dimensiones de la serie configurable

d ₁ min.	d ₁ max.	d ₂ h6	l ₁	l ₂	l ₃	l ₄
3,00	3,70	6	92	54	48	36
3,71	4,70	6	102	64	58	36
4,71	6,00	6	116	78	70	36
6,01	8,00	8	146	108	94	36
8,01	10,00	10	162	120	110	40
10,01	12,00	12	204	156	142	45
12,01	14,00	14	230	182	166	45
14,01	16,00	16	260	208	192	48
16,01	18,00	18	285	234	216	48
18,01	20,00	20	310	258	240	50

Ejemplo:

SCD131-0431-2-2-140HE12-HU630

Forma del mango HE

Diámetro de la herramienta d₁ = 4,31 mm

Medidas en mm.

Para la recomendación de valores de corte, véase al final del capítulo.
Ejecuciones especiales y otros recubrimientos a petición.

MEGA-Drill-Composite-MD

Broca helicoidal de metal duro

SCD250 (5xD), suministro de refrigerante exterior

Ejecución:

Diámetro de broca: 0,50 – 12,00 mm

Material de corte: HC611/619/620

Número de insertos: 2

Número de bisel guía: 2

Ángulo de la punta: 90°

Ángulo de hélice: 35°

Aplicación:

CFK con fibras multidireccionales.

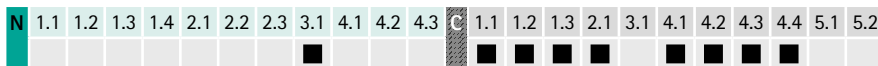
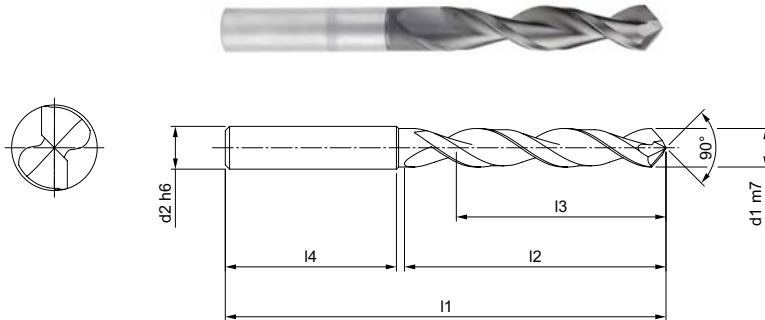

Dimensiones						Forma del mango HA	
d ₁ m7	d ₂ h6	l ₁	l ₂	l ₃	l ₄	Especificación	Referencia
0,50	3	55	4,5	3	46	SCD250-0050-2-2-140HA05-HC620	30504673
2,00	3	68	14	11	51	SCD250-0200-2-2-140HA05-HC620	30504688
2,50	3	74	18	14	54	SCD250-0250-2-2-140HA05-HC620	30504693
3,00	6	66	28	23	36	SCD250-0300-2-2-090HA05-HC619	30401902
3,10	6	66	28	23	36	SCD250-0310-2-2-090HA05-HC619	30401903
3,20	6	66	28	23	36	SCD250-0320-2-2-090HA05-HC619	30401905
3,30	6	66	28	23	36	SCD250-0330-2-2-090HA05-HC619	30401906
3,80	6	66	28	23	36	SCD250-0380-2-2-090HA05-HC619	30401911
4,00	6	74	36	29	36	SCD250-0400-2-2-090HA05-HC619	30401913
4,10	6	74	36	29	36	SCD250-0410-2-2-090HA05-HC619	30401914
4,20	6	74	36	29	36	SCD250-0420-2-2-090HA05-HC619	30401915
4,30	6	74	36	29	36	SCD250-0430-2-2-090HA05-HC619	30401916
4,50	6	74	36	29	36	SCD250-0450-2-2-090HA05-HC619	30401918
4,80	6	74	36	29	36	SCD250-0480-2-2-090HA05-HC619	30401922
4,86	6	74	36	0	36	SCD250-0486-2-2-090HA05-HC619	30681789
5,00	6	82	44	35	36	SCD250-0500-2-2-090HA05-HC619	30401924
5,10	6	82	44	35	36	SCD250-0510-2-2-090HA05-HC619	30401925
5,20	6	82	44	35	36	SCD250-0520-2-2-090HA05-HC619	30401926
5,30	6	82	44	35	36	SCD250-0530-2-2-090HA05-HC619	30401927
5,50	6	82	44	35	36	SCD250-0550-2-2-090HA05-HC619	30401929
5,60	6	82	44	35	36	SCD250-0560-2-2-090HA05-HC619	30401930
5,80	6	82	44	35	36	SCD250-0580-2-2-090HA05-HC619	30401932
6,00	6	82	44	35	36	SCD250-0600-2-2-090HA05-HC619	30401934
6,50	8	91	53	43	36	SCD250-0650-2-2-090HA05-HC619	30401940
6,80	8	91	53	43	36	SCD250-0680-2-2-090HA05-HC619	30401943
7,00	8	91	53	43	36	SCD250-0700-2-2-090HA05-HC619	30401945
7,20	8	91	53	43	36	SCD250-0720-2-2-090HA05-HC619	30401947
7,50	8	91	53	43	36	SCD250-0750-2-2-090HA05-HC619	30401950
7,80	8	91	53	43	36	SCD250-0780-2-2-090HA05-HC619	30401953
8,00	8	91	53	43	36	SCD250-0800-2-2-090HA05-HC619	30401956
8,50	10	103	61	49	40	SCD250-0850-2-2-090HA05-HC611	30401961
8,80	10	103	61	49	40	SCD250-0880-2-2-090HA05-HC611	30401964
10,00	10	103	61	49	40	SCD250-1000-2-2-090HA05-HC611	30401977

MEGA-Drill-Composite-MD | Broca helicoidal de metal duro SCD250 (5xD), suministro de refrigerante exterior

Dimensiones						Forma del mango HA	
d ₁ m7	d ₂ h6	l ₁	l ₂	l ₃	l ₄	Especificación	Referencia
10,10	12	118	71	56	45	SCD250-1010-2-2-090HA05-HC611	30401978
10,40	12	118	71	56	45	SCD250-1040-2-2-090HA05-HC611	30401981
10,70	12	118	71	56	45	SCD250-1070-2-2-090HA05-HC611	30401984
12,00	12	118	71	56	45	SCD250-1200-2-2-090HA05-HC611	30401998

Características configurables

**Diámetro:**

Diámetro seleccionable libremente en incrementos de 0,01 mm

**Forma del mango:**

Forma del mango: HB | HE

Especificación

SCD250-[diámetro]-2-2-090[forma del mango]05-HC611

Dimensiones de la serie configurable

d ₁ min.	d ₁ max.	d ₂ h6	l ₁	l ₂	l ₃	l ₄
3,00	3,99	6	66	28	23	36
4,00	4,99	6	74	36	29	36
5,00	6,00	6	82	44	35	36
6,01	8,00	8	91	53	43	36
8,01	10,00	10	103	61	49	40
10,01	12,00	12	118	71	56	45

Ejemplo:

SCD250-0431-2-2-090HE05-HC611

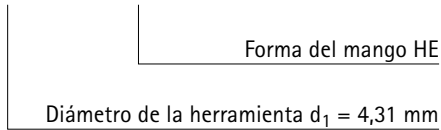

Medidas en mm.

Para la recomendación de valores de corte, véase al final del capítulo.

Ejecuciones especiales y otros recubrimientos a petición.

MEGA-Drill-Composite-UDX

Broca helicoidal de metal duro

SCD270 (5xD), suministro de refrigerante exterior

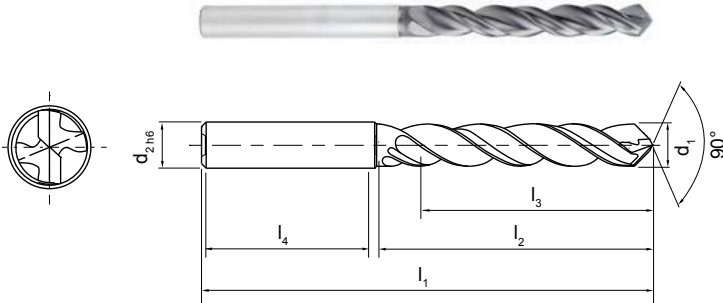

N	1.1	1.2	1.3	1.4	2.1	2.2	2.3	3.1	4.1	4.2	4.3	C	1.1	1.2	1.3	2.1	3.1	4.1	4.2	4.3	4.4	5.1	5.2
---	-----	-----	-----	-----	-----	-----	-----	-----	-----	-----	-----	---	-----	-----	-----	-----	-----	-----	-----	-----	-----	-----	-----



Serie preferente disponible en stock en forma de mango HA

Dimensiones						Forma del mango HA	
d ₁ m7	d ₂ h6	l ₁	l ₂	l ₃	l ₄	Especificación	Referencia
3,30	6	66	26	20	36	SCD270-0330-2-2-090HA05-HC619	30402105
4,00	6	74	35	27	36	SCD270-0400-2-2-090HA05-HC619	30402112
4,394	6	74	35	27	36	SCD270-04394-2-2-090HA05-HC619	30634827
4,50	6	74	35	27	36	SCD270-0450-2-2-090HA05-HC619	30402117
5,00	6	82	44	35	36	SCD270-0500-2-2-090HA05-HC619	30402123

Características configurables



Diámetro:

Diámetro seleccionable libremente en incrementos de 0,01 mm



Forma del mango:

Forma del mango: HB | HE

Especificación

SCD270-[diámetro]-2-2-090[forma del mango]05-HC619

Dimensiones de la serie configurable

d ₁ min.	d ₁ max.	d ₂ h6	l ₁	l ₂	l ₃	l ₄
3,00	3,99	6	66	26	20	36
4,00	4,99	6	74	35	27	36
5,00	6,00	6	82	44	35	36
6,01	8,00	8	91	52	40	36
8,01	10,00	10	103	60	45	40
10,01	12,00	12	118	70	52	45

Ejemplo:

SCD270-0431-2-2-090HE05-HC619

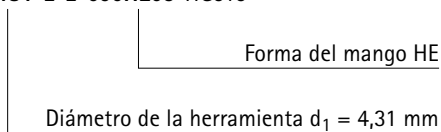

Medidas en mm.

Para la recomendación de valores de corte, véase al final del capítulo.

Ejecuciones especiales y otros recubrimientos a petición.

MEGA-Drill-Composite-UDX

Broca helicoidal de metal duro
SCD271 (5xD), suministro de refrigerante interior

Ejecución:

Diámetro de broca: 6,00 - 12,00 mm
Material de corte: HC619
Número de insertos: 2
Número de biseles guía: 3
Ángulo de la punta: 90°
Ángulo de hélice: 35°

Aplicación:

Para todos los materiales de CFK/solucionadora de problemas en situaciones de sujeción inestables o componentes de paredes finas.

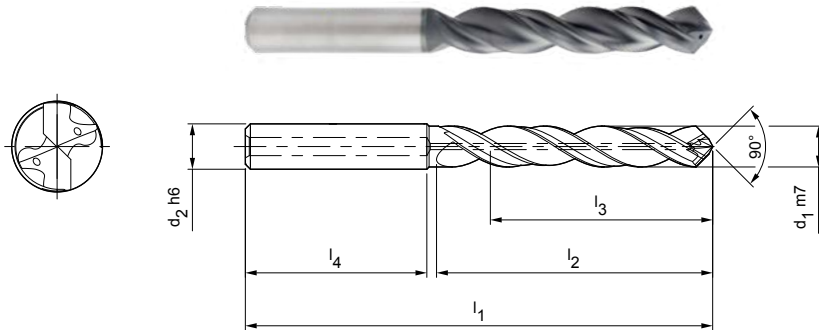

N	1.1	1.2	1.3	1.4	2.1	2.2	2.3	3.1	4.1	4.2	4.3	C	1.1	1.2	1.3	2.1	3.1	4.1	4.2	5.1	5.2	5.3	
								■				■		■	■	■							



Serie preferente disponible en stock en forma de mango HA

Dimensiones						Forma del mango HA	
d ₁ m7	d ₂ h6	l ₁	l ₂	l ₃	l ₄	Especificación	Referencia
6,00	6	82	44	35	36	SCD271-0600-2-2-090HA05-HC619	30402197
8,00	8	91	52	40	36	SCD271-0800-2-2-090HA05-HC619	30402219
10,00	10	103	60	45	40	SCD271-1000-2-2-090HA05-HC611	30402240

Características configurables



Diámetro:

Diámetro seleccionable libremente en incrementos de 0,01 mm



Forma del mango:

Forma del mango: HB | HE

Especificación

SCD271-[diámetro]-2-2-090[forma del mango]05-HC619

Dimensiones de la serie configurable

d ₁ min.	d ₁ max.	d ₂ h6	l ₁	l ₂	l ₃	l ₄
6,00	6,00	6	82	44	35	36
6,01	8,00	8	91	52	40	36
8,01	10,00	10	103	60	45	40
10,01	12,00	12	118	70	52	45

Ejemplo:

SCD271-0431-2-2-090HE05-HC619

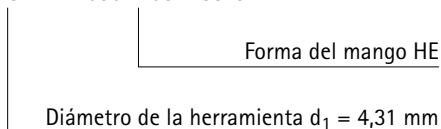

Medidas en mm.

Para la recomendación de valores de corte, véase al final del capítulo.

Ejecuciones especiales y otros recubrimientos a petición.

MEGA-180°-Drill-Alu

Broca helicoidal de metal duro

SCD241 (3xD), suministro de refrigerante interior

Ejecución:

Diámetro de broca:	3,00 – 20,00 mm
Tolerancia del agujero:	≥ IT 9
Material de corte:	HU630
Número de insertos:	2
Número de bisel guía:	4
Ángulo de la punta:	180°
Ángulo de hélice:	30°

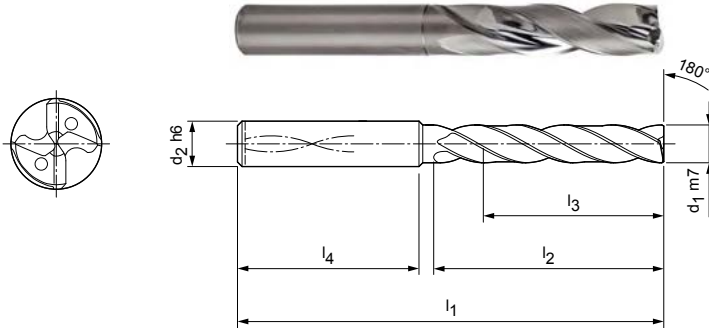

Serie preferente disponible en stock en forma de mango HA

Dimensiones						Forma del mango HA	
d ₁ m7	d ₂ h6	l ₁	l ₂	l ₃	l ₄	Especificación	Referencia
3,00	6	62	20	14	36	SCD241-0300-2-4-180HA03-HU630	30382883
3,70	6	62	20	14	36	SCD241-0370-2-4-180HA03-HU630	30382890
4,00	6	66	24	17	36	SCD241-0400-2-4-180HA03-HU630	30382893
4,20	6	66	24	17	36	SCD241-0420-2-4-180HA03-HU630	30382895
4,30	6	66	24	17	36	SCD241-0430-2-4-180HA03-HU630	30382896
4,60	6	66	24	17	36	SCD241-0460-2-4-180HA03-HU630	30382899
5,00	6	66	28	20	36	SCD241-0500-2-4-180HA03-HU630	30382904
5,50	6	66	28	20	36	SCD241-0550-2-4-180HA03-HU630	30382909
5,56	6	66	28	20	36	SCD241-0556-2-4-180HA03-HU630	30463897
6,00	6	66	28	20	36	SCD241-0600-2-4-180HA03-HU630	30382915
6,50	8	79	34	24	36	SCD241-0650-2-4-180HA03-HU630	30382920
6,70	8	79	34	24	36	SCD241-0670-2-4-180HA03-HU630	30382922
7,00	8	79	34	24	36	SCD241-0700-2-4-180HA03-HU630	30382925
7,20	8	79	41	29	36	SCD241-0720-2-4-180HA03-HU630	30382927
7,40	8	79	41	29	36	SCD241-0740-2-4-180HA03-HU630	30382929
7,50	8	79	41	29	36	SCD241-0750-2-4-180HA03-HU630	30382930
7,80	8	79	41	29	36	SCD241-0780-2-4-180HA03-HU630	30382933
8,00	8	79	41	29	36	SCD241-0800-2-4-180HA03-HU630	30382935
8,50	10	89	47	35	40	SCD241-0850-2-4-180HA03-HU630	30382940
8,90	10	89	47	35	40	SCD241-0890-2-4-180HA03-HU630	30382944
9,00	10	89	47	35	40	SCD241-0900-2-4-180HA03-HU630	30382945
9,20	10	89	47	35	40	SCD241-0920-2-4-180HA03-HU630	30382947
9,80	10	89	47	35	40	SCD241-0980-2-4-180HA03-HU630	30382953
10,00	10	89	47	35	40	SCD241-1000-2-4-180HA03-HU630	30382955
11,00	12	100	53	38	45	SCD241-1100-2-4-180HA03-HU630	30382965
12,00	12	100	53	38	45	SCD241-1200-2-4-180HA03-HU630	30382975
13,00	14	105	58	41	45	SCD241-1300-2-4-180HA03-HU630	30382978
14,50	16	113	63	43	48	SCD241-1450-2-4-180HA03-HU630	30382982
17,00	18	121	71	49	48	SCD241-1700-2-4-180HA03-HU630	30382990
18,50	20	129	77	53	50	SCD241-1850-2-4-180HA03-HU630	30382994

MEGA-180°-Drill-Alu | Broca helicoidal de metal duro SCD241 (3xD), suministro de refrigerante interior

Características configurables

**Diámetro:**

Diámetro seleccionable libremente en incrementos de 0,01 mm

**Forma del mango:**

Forma del mango: HB | HE

Especificación

SCD241-[diámetro]-2-4-180[forma del mango]03-HU630

Dimensiones de la serie configurable

d ₁ min.	d ₁ max.	d ₂ h6	l ₁	l ₂	l ₃	l ₄
3,00	3,70	6	62	20	14	36
3,71	4,70	6	66	24	17	36
4,71	6,00	6	66	28	20	36
6,01	6,80	8	79	34	24	36
6,81	8,00	8	79	41	29	36
8,01	10,00	10	89	47	35	40
10,01	12,00	12	100	53	38	45
12,0	14,00	14	105	58	41	45
14,01	16,00	16	113	63	43	48
16,01	18,00	18	121	71	49	48
18,01	20,00	20	129	77	53	50

Ejemplo:

SCD241-0431-2-4-180HE03-HU630

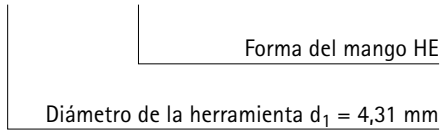

Medidas en mm.

Para la recomendación de valores de corte, véase al final del capítulo.

Ejecuciones especiales y otros recubrimientos a petición.

MEGA-180°-Drill-Alu

Broca helicoidal de metal duro

SCD241 (5xD), suministro de refrigerante interior

Ejecución:

Diámetro de broca:	3,00 – 20,00 mm
Tolerancia del agujero:	≥ IT 9
Material de corte:	HU630
Número de insertos:	2
Número de bisel guía:	4
Ángulo de la punta:	180°
Ángulo de hélice:	30°

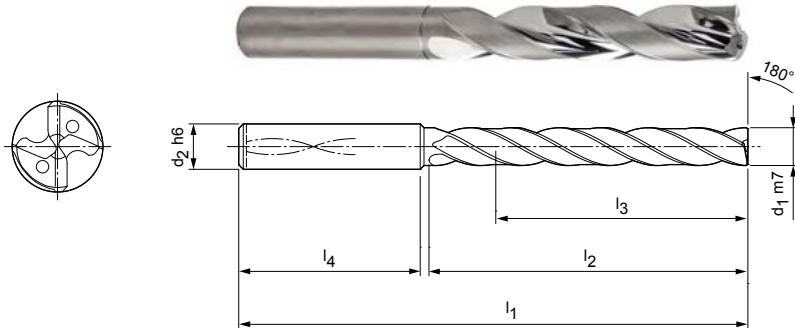

Serie preferente disponible en stock en forma de mango HA

Dimensiones						Forma del mango HA	
d ₁ m7	d ₂ h6	l ₁	l ₂	l ₃	l ₄	Especificación	Referencia
3,00	6	66	28	23	36	SCD241-0300-2-4-180HA05-HU630	30383000
3,50	6	66	28	23	36	SCD241-0350-2-4-180HA05-HU630	30383005
4,00	6	74	36	29	36	SCD241-0400-2-4-180HA05-HU630	30383010
4,10	6	74	36	29	36	SCD241-0410-2-4-180HA05-HU630	30383011
4,80	6	82	44	35	36	SCD241-0480-2-4-180HA05-HU630	30383019
5,00	6	82	44	35	36	SCD241-0500-2-4-180HA05-HU630	30383021
5,60	6	82	44	35	36	SCD241-0560-2-4-180HA05-HU630	30383028
6,00	6	82	44	35	36	SCD241-0600-2-4-180HA05-HU630	30383032
6,50	8	91	53	43	36	SCD241-0650-2-4-180HA05-HU630	30383037
7,00	8	91	53	43	36	SCD241-0700-2-4-180HA05-HU630	30383042
7,50	8	91	53	43	36	SCD241-0750-2-4-180HA05-HU630	30383047
8,00	8	91	53	43	36	SCD241-0800-2-4-180HA05-HU630	30383052
8,20	10	103	61	49	40	SCD241-0820-2-4-180HA05-HU630	30383054
8,50	10	103	61	49	40	SCD241-0850-2-4-180HA05-HU630	30383057
9,00	10	103	61	49	40	SCD241-0900-2-4-180HA05-HU630	30383062
9,30	10	103	61	49	40	SCD241-0930-2-4-180HA05-HU630	30383066
10,00	10	103	61	49	40	SCD241-1000-2-4-180HA05-HU630	30383073
12,00	12	116	69	54	45	SCD241-1200-2-4-180HA05-HU630	30383093
13,00	14	122	75	58	45	SCD241-1300-2-4-180HA05-HU630	30383096
14,00	14	122	75	58	45	SCD241-1400-2-4-180HA05-HU630	30383099
15,00	16	131	81	61	48	SCD241-1500-2-4-180HA05-HU630	30383102
15,70	16	131	81	61	48	SCD241-1570-2-4-180HA05-HU630	31237410
20,00	20	151	99	75	50	SCD241-2000-2-4-180HA05-HU630	30383117

MEGA-180°-Drill-Alu | Broca helicoidal de metal duro SCD241 (5xD), suministro de refrigerante interior

Características configurables

**Diámetro:**

Diámetro seleccionable libremente en incrementos de 0,01 mm

**Forma del mango:**

Forma del mango: HB | HE

Especificación

SCD241-[diámetro]-2-4-180[forma del mango]05-HU630

Dimensiones de la serie configurable

d ₁ min.	d ₁ max.	d ₂ h6	l ₁	l ₂	l ₃	l ₄
3,00	3,70	6	66	28	23	36
3,71	4,70	6	74	36	29	36
4,71	6,00	6	82	44	35	36
6,01	8,00	8	91	53	43	36
8,01	10,00	10	103	61	49	40
10,01	12,00	12	116	69	54	45
12,01	14,00	14	122	75	58	45
14,01	16,00	16	131	81	61	48
16,01	18,00	18	141	91	69	48
18,01	20,00	20	151	99	75	50

Ejemplo:

SCD241-0431-2-4-180HE05-HU630

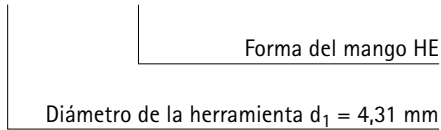

Medidas en mm.

Para la recomendación de valores de corte, véase al final del capítulo.

Ejecuciones especiales y otros recubrimientos a petición.

ECU-G-Drill

Broca fabricada por completo en metal duro, con ranura recta
SCD211 (5xD), suministro de refrigerante interior

Ejecución:

Diámetro de broca: 4,80 – 7,50 mm
Tolerancia del agujero: \geq IT 9
Material de corte: HU610
Número de insertos: 2
Número de bisel guía: 4
Ángulo de la punta: 130°

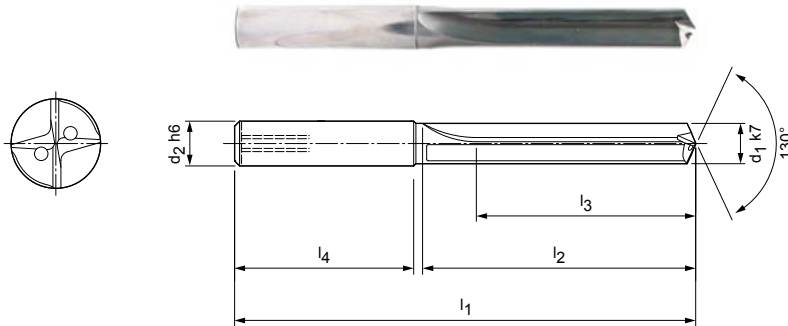

Serie preferente disponible en stock en forma de mango HA

Dimensiones						Forma del mango HA	
d ₁ k7	d ₂ h6	l ₁	l ₂	l ₃	l ₄	Especificación	Referencia
4,80	6	82	44	35	36	SCD211-0480-2-4-130HA05-HU610	30392622
5,50	6	82	44	35	36	SCD211-0550-2-4-130HA05-HU610	30392630
5,70	6	82	44	35	36	SCD211-0570-2-4-130HA05-HU610	30392632
5,80	6	82	44	35	36	SCD211-0580-2-4-130HA05-HU610	30392633
6,80	8	91	53	43	36	SCD211-0680-2-4-130HA05-HU610	30392643
7,40	8	91	53	43	36	SCD211-0740-2-4-130HA05-HU610	30392649
7,50	8	91	53	43	36	SCD211-0750-2-4-130HA05-HU610	30392650

Características configurables



Forma del mango:
Forma del mango: HB | HE



Especificación

SCD211-0430-2-4-130[forma del mango]05-HU610

Ejemplo:

SCD211-0430-3-3-140HE05-HU610

Forma del mango HE

Medidas en mm.

Para la recomendación de valores de corte, véase al final del capítulo.

Ejecuciones especiales y otros recubrimientos a petición.

ECU-G-Drill

Broca fabricada por completo en metal duro, con ranura recta
SCD211 (8xD), suministro de refrigerante interior

Ejecución:

Diámetro de broca: 5,80 – 11,60 mm
Tolerancia del agujero: ≥ IT 9
Material de corte: HU610
Número de insertos: 2
Número de biseles guía: 4
Ángulo de la punta: 130 °

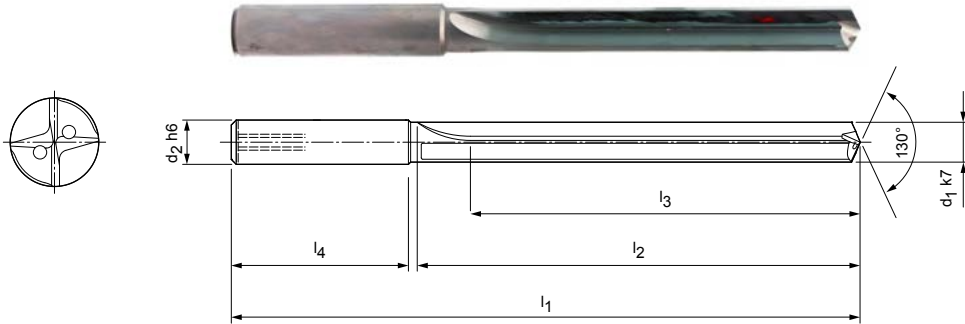

Serie preferente disponible en stock en forma de mango HA

Dimensiones						Forma del mango HA	
d ₁ k7	d ₂ h6	l ₁	l ₂	l ₃	l ₄	Especificación	Referencia
5,80	6	95	57	48	36	SCD211-0580-2-4-130HA08-HU610	30392739
11,60	12	162	114	96	45	SCD211-1160-2-4-130HA08-HU610	30392797

Características configurables

Forma del mango:
Forma del mango: HB | HE

Especificación
SCD211-0430-2-4-130[forma del mango]08-HU610

Ejemplo:

SCD211-0430-3-3-140HE08-HU610

Forma del mango HE

Medidas en mm.

Para la recomendación de valores de corte, véase al final del capítulo.
Ejecuciones especiales y otros recubrimientos a petición.

Recomendación de valores de corte para brocas fabricadas por completo en metal duro

Avance y velocidad de corte

Tritan-Drill-Uni-Plus | SCD631

Grupo de arranque de vi-rutas de Mapal*		Material	Rigidez/dureza [N/mm ²] [HRC]
P	P1	P1.1 Aceros de construcción, para tornos automáticos, de cementación y revenidos, no aleados	< 700
		P1.2 Aceros de construcción, para tornos automáticos, de cementación y revenidos, no aleados	< 1200
	P2	P2.1 Aceros nitrurados, de cementación y aceros revenidos, aleados	< 900
		P2.2 Aceros nitrurados, de cementación y aceros revenidos, aleados	< 1400
	P3	P3.1 Aceros para herramientas, rodamientos, resortes y rápidos**	< 800
		P3.2 Aceros para herramientas, rodamientos, resortes y rápidos**	< 1000
		P3.3 Aceros para herramientas, rodamientos, resortes y rápidos**	< 1500
	P5	P5.1 Fundición de acero	
M	M1	M1.1 Aceros inoxidables, austeníticos	< 700
		M1.2 Aceros inoxidables, ferríticos/austeníticos (dúplex)	< 1000
K	K1	K1.1 Hierro fundido con grafito laminar (fundición gris), GJL	< 300
		K2.1 Hierro fundido con grafito esferoidal, GJS	< 500
		K2.2 Hierro fundido con grafito esferoidal, GJS	≤ 800
	K3	K2.3 Hierro fundido con grafito esferoidal, GJS	> 800
		K3.1 Hierro fundido con grafito vermicular, GJV; fundición maleable, GJM	< 500
		K3.2 Hierro fundido con grafito vermicular, GJV; fundición maleable, GJM	> 500
N	N1	N1.1 Aluminio, aleado y no aleado < 3 % Si	
		N1.2 Aluminio, aleado ≤ 7 % Si	
		N1.3 Aluminio, aleado > 7-12 % Si	
		N1.4 Aluminio, aleado > 12 % Si	
	N2	N2.1 Cobre, no aleado y de baja aleación	< 300
		N2.2 Cobre, aleado	> 300
		N2.3 Latón, bronce, fundición roja	< 1200

MEGA-Speed-Drill-Uni | SCD221

Grupo de arranque de vi-rutas de Mapal*		Material	Rigidez/dureza [N/mm ²] [HRC]
P	P1	P1.1 Aceros de construcción, para tornos automáticos, de cementación y revenidos, no aleados	< 700
		P1.2 Aceros de construcción, para tornos automáticos, de cementación y revenidos, no aleados	< 1200
	P2	P2.1 Aceros nitrurados, de cementación y aceros revenidos, aleados	< 900
		P2.2 Aceros nitrurados, de cementación y aceros revenidos, aleados	< 1400
	P3	P3.1 Aceros para herramientas, rodamientos, resortes y rápidos**	< 800
		P3.2 Aceros para herramientas, rodamientos, resortes y rápidos**	< 1000
		P3.3 Aceros para herramientas, rodamientos, resortes y rápidos**	< 1500
	P4	P4.1 Aceros inoxidables, ferríticos y martensíticos	
	P5	P5.1 Fundición de acero	
	P6	P6.1 Fundición de acero inoxidable, ferrítica y martensítica	
K	K1	K1.1 Hierro fundido con grafito laminar (fundición gris), GJL	< 300
		K2.1 Hierro fundido con grafito esferoidal, GJS	< 500
		K2.2 Hierro fundido con grafito esferoidal, GJS	≤ 800
	K3	K2.3 Hierro fundido con grafito esferoidal, GJS	> 800
		K3.1 Hierro fundido con grafito vermicular, GJV; fundición maleable, GJM	< 500
		K3.2 Hierro fundido con grafito vermicular, GJV; fundición maleable, GJM	> 500

* Grupos de mecanizado MAPAL

** Si los componentes de aleación de Cr, Mo, Ni, V, W suman > 8 %, elegir el siguiente grupo de mecanizado MAPAL superior.

	Velocidad de corte v_c [m/min]				Avance f [mm] con diámetro de broca					
	Refrigeración interna	Refrigeración exterior	MMS	Aire	4,00	5,50	7,50	10,50	14,50	20,00
	115	105	105		0,22	0,27	0,34	0,42	0,51	0,59
	105	85	85		0,27	0,34	0,42	0,53	0,64	0,74
	115	100	100		0,25	0,32	0,40	0,50	0,60	0,70
	80	70	70		0,21	0,26	0,32	0,40	0,48	0,55
	85	75	75		0,23	0,29	0,36	0,45	0,54	0,63
	70	65	65		0,19	0,24	0,30	0,37	0,44	0,51
	70	50	60		0,16	0,19	0,24	0,29	0,34	0,40
	115	100	100		0,25	0,32	0,40	0,50	0,60	0,70
	55	35	35		0,11	0,14	0,18	0,22	0,27	0,31
	140	100	100	100	0,31	0,41	0,53	0,68	0,84	0,98
	185	115	140	140	0,30	0,39	0,50	0,64	0,78	0,91
	115	85	85		0,27	0,35	0,44	0,55	0,67	0,78
	70	45	60		0,14	0,18	0,22	0,28	0,33	0,38
	105	90	90		0,29	0,37	0,47	0,59	0,72	0,84
	90	80	80		0,25	0,31	0,38	0,48	0,57	0,66
	345	230	290		0,22	0,27	0,34	0,42	0,51	0,59
	290	205	230		0,27	0,35	0,44	0,55	0,67	0,78
	255	175	205		0,27	0,35	0,44	0,55	0,67	0,78
	205	140	175		0,27	0,35	0,44	0,55	0,67	0,78
	140	105			0,20	0,26	0,33	0,41	0,50	0,58
	230	185	185	140	0,31	0,41	0,53	0,68	0,84	0,98

	Velocidad de corte v_c [m/min]				Avance f [mm] con diámetro de broca					
	Refrigeración interna	Refrigeración exterior	MMS	Aire	3,00	4,50	6,50	9,50	14,00	20,00
	170	155	155		0,11	0,14	0,18	0,23	0,30	0,36
	155	130	130		0,14	0,18	0,22	0,29	0,37	0,45
	170	145	145		0,13	0,17	0,21	0,27	0,35	0,43
	120	100	100		0,11	0,14	0,17	0,22	0,28	0,34
	130	110	110		0,11	0,15	0,19	0,25	0,32	0,38
	115	100	95		0,10	0,14	0,17	0,22	0,28	0,35
	100	75	85		0,10	0,13	0,16	0,20	0,26	0,31
	100	75	85		0,08	0,10	0,13	0,16	0,21	0,25
	170	145	145		0,13	0,17	0,21	0,27	0,35	0,43
	100	75	85		0,08	0,10	0,13	0,16	0,21	0,25
	150	105	105	105	0,13	0,19	0,26	0,35	0,45	0,54
	200	125	150	150	0,13	0,18	0,25	0,33	0,42	0,50
	125	95	95		0,12	0,16	0,22	0,28	0,36	0,43
	75	50	65		0,09	0,12	0,15	0,19	0,24	0,28
	115	100	100		0,13	0,18	0,23	0,31	0,39	0,46
	100	90	90		0,11	0,15	0,19	0,25	0,31	0,36

Los valores de corte indicados son de referencia.

Los datos óptimos para cada situación de mecanizado deben determinarse mediante ensayos o durante el propio proceso de mecanizado.

Recomendación de valores de corte para brocas fabricadas por completo en metal duro

Avance y velocidad de corte

ECU-Drill-Uni | SCD350, 351

Grupo de arranque de vi-rutas de Mapal*		Material	Rigidez/dureza [N/mm ²] [HRC]
P	P1	P1.1 Aceros de construcción, para tornos automáticos, de cementación y revenidos, no aleados	< 700
		P1.2 Aceros de construcción, para tornos automáticos, de cementación y revenidos, no aleados	< 1200
	P2	P2.1 Aceros nitruados, de cementación y aceros revenidos, aleados	< 900
		P2.2 Aceros nitruados, de cementación y aceros revenidos, aleados	< 1400
	P3	P3.1 Aceros para herramientas, rodamientos, resortes y rápidos**	< 800
		P3.2 Aceros para herramientas, rodamientos, resortes y rápidos**	< 1000
		P3.3 Aceros para herramientas, rodamientos, resortes y rápidos**	< 1500
	P5	P5.1 Fundición de acero	
M	M1	M1.1 Aceros inoxidables, austeníticos	< 700
		M1.2 Aceros inoxidables, ferríticos/austeníticos (dúplex)	< 1000
	M2	M2.1 Fundición de acero inoxidable, austenítica	< 700
	M3	M3.1 Fundición de acero inoxidable, ferrítica/austenítica (dúplex)	< 1000
K	K2	K2.1 Hierro fundido con grafito esférico, GJS	< 500
		K2.2 Hierro fundido con grafito esférico, GJS	≤ 800
		K2.3 Hierro fundido con grafito esférico, GJS	> 800

MEGA-Drill-Steel-Plus | SCD600, 601

Grupo de arranque de vi-rutas de Mapal*		Material	Rigidez/dureza [N/mm ²] [HRC]
P	P1	P1.1 Aceros de construcción, para tornos automáticos, de cementación y revenidos, no aleados	< 700
		P1.2 Aceros de construcción, para tornos automáticos, de cementación y revenidos, no aleados	< 1200
	P2	P2.1 Aceros nitruados, de cementación y aceros revenidos, aleados	< 900
		P2.2 Aceros nitruados, de cementación y aceros revenidos, aleados	< 1400
	P3	P3.1 Aceros para herramientas, rodamientos, resortes y rápidos**	< 800
		P3.2 Aceros para herramientas, rodamientos, resortes y rápidos**	< 1000
		P3.3 Aceros para herramientas, rodamientos, resortes y rápidos**	< 1500
	P4	P4.1 Aceros inoxidables, ferríticos y martensíticos	
	P5	P5.1 Fundición de acero	
	P6	P6.1 Fundición de acero inoxidable, ferrítica y martensítica	
K	K1	K1.1 Hierro fundido con grafito laminar (fundición gris), GJL	< 300
		K2.1 Hierro fundido con grafito esférico, GJS	< 500
	K2	K2.2 Hierro fundido con grafito esférico, GJS	≤ 800
		K2.3 Hierro fundido con grafito esférico, GJS	> 800
	K3	K3.1 Hierro fundido con grafito vermicular, GJV; fundición maleable, GJM	< 500
		K3.2 Hierro fundido con grafito vermicular, GJV; fundición maleable, GJM	> 500
H	H1	H1.1 Acero templado/fundición de acero	< 44
		H1.2 Acero templado/fundición de acero	< 55

* Grupos de mecanizado MAPAL

** Si los componentes de aleación de Cr, Mo, Ni, V, W suman > 8 %, elegir el siguiente grupo de mecanizado MAPAL superior.

	Velocidad de corte v_c [m/min]				Avance f [mm] con diámetro de broca					
	Refrigeración interna	Refrigeración exterior	MMS	Aire	1,00	1,82	3,31	6,03	10,99	20,00
	75	70	70		0,03	0,05	0,07	0,10	0,16	0,21
	70	55	55		0,04	0,06	0,08	0,13	0,20	0,27
	75	65	65		0,04	0,05	0,08	0,12	0,18	0,25
	55	45	45		0,04	0,05	0,07	0,10	0,15	0,20
	55	50	50		0,03	0,05	0,07	0,11	0,17	0,23
	45	40	40		0,03	0,04	0,06	0,09	0,14	0,18
	45	35	40		0,03	0,04	0,05	0,07	0,11	0,14
	75	65	65		0,04	0,05	0,08	0,12	0,18	0,25
	45	30	30		0,03	0,04	0,06	0,09	0,14	0,19
	45	25	25		0,02	0,03	0,05	0,08	0,12	0,16
	45	30	30		0,03	0,04	0,06	0,09	0,14	0,19
	45	25	25		0,02	0,03	0,05	0,08	0,12	0,16
	120	75	90	90	0,05	0,07	0,12	0,19	0,30	0,41
	75	55	55		0,04	0,07	0,11	0,17	0,26	0,35

	Velocidad de corte v_c [m/min]				Avance f [mm] con diámetro de broca					
	Refrigeración interna	Refrigeración exterior	MMS	Aire	3,00	4,50	6,50	9,50	14,00	20,00
	110	100	100		0,10	0,13	0,17	0,22	0,28	0,33
	100	85	85		0,12	0,16	0,21	0,27	0,34	0,41
	110	95	95		0,11	0,15	0,20	0,26	0,33	0,38
	75	65	65		0,10	0,13	0,16	0,21	0,26	0,30
	85	70	70		0,10	0,14	0,18	0,23	0,29	0,35
	65	60	60		0,09	0,12	0,15	0,19	0,24	0,28
	65	50	55		0,07	0,09	0,12	0,15	0,19	0,22
	65	50	55		0,07	0,09	0,12	0,15	0,19	0,23
	110	95	95		0,11	0,15	0,20	0,26	0,33	0,38
	65	50	55		0,07	0,09	0,12	0,15	0,19	0,23
	120	85	85	85	0,13	0,19	0,26	0,35	0,45	0,54
	160	100	120	120	0,13	0,18	0,25	0,33	0,42	0,50
	100	75	75		0,12	0,16	0,22	0,28	0,36	0,43
	60	40	50		0,09	0,12	0,15	0,19	0,24	0,28
	90	80	80		0,13	0,18	0,23	0,31	0,39	0,46
	80	70	70		0,11	0,15	0,19	0,25	0,31	0,36
	90	90	90		0,09	0,12	0,15	0,19	0,24	0,28
	25	25	25		0,05	0,06	0,08	0,11	0,14	0,16

Los valores de corte indicados son de referencia.

Los datos óptimos para cada situación de mecanizado deben determinarse mediante ensayos o durante el propio proceso de mecanizado.

Recomendación de valores de corte para brocas fabricadas por completo en metal duro

Avance y velocidad de corte

MEGA-Quadro-Drill-Plus | SCD610, 611

Grupo de arranque de vi-rutas de Mapal*		Material	Rigidez/dureza [N/mm ²] [HRC]
P	P1	P1.1 Aceros de construcción, para tornos automáticos, de cementación y revenidos, no aleados	< 700
		P1.2 Aceros de construcción, para tornos automáticos, de cementación y revenidos, no aleados	< 1200
	P2	P2.1 Aceros nitrurados, de cementación y aceros revenidos, aleados	< 900
		P2.2 Aceros nitrurados, de cementación y aceros revenidos, aleados	< 1400
	P3	P3.1 Aceros para herramientas, rodamientos, resortes y rápidos*	< 800
		P3.2 Aceros para herramientas, rodamientos, resortes y rápidos*	< 1000
		P3.3 Aceros para herramientas, rodamientos, resortes y rápidos*	< 1500
	P5	P5.1 Fundición de acero	
K	K1	K1.1 Hierro fundido con grafito laminar (fundición gris), GJL	< 300
		K2.1 Hierro fundido con grafito esferoidal, GJS	< 500
	K2	K2.2 Hierro fundido con grafito esferoidal, GJS	≤ 800
		K2.3 Hierro fundido con grafito esferoidal, GJS	> 800
	K3	K3.1 Hierro fundido con grafito vermicular, GJV; fundición maleable, GJM	< 500
		K3.2 Hierro fundido con grafito vermicular, GJV; fundición maleable, GJM	> 500

MICRO-Drill-Steel | SCD371

Grupo de arranque de vi-rutas de Mapal*		Material	Rigidez/dureza [N/mm ²] [HRC]
P	P1	P1.1 Aceros de construcción, para tornos automáticos, de cementación y revenidos, no aleados	< 700
		P1.2 Aceros de construcción, para tornos automáticos, de cementación y revenidos, no aleados	< 1200
	P2	P2.1 Aceros nitrurados, de cementación y aceros revenidos, aleados	< 900
		P2.2 Aceros nitrurados, de cementación y aceros revenidos, aleados	< 1400
	P3	P3.1 Aceros para herramientas, rodamientos, resortes y rápidos*	< 800
		P3.2 Aceros para herramientas, rodamientos, resortes y rápidos*	< 1000
		P3.3 Aceros para herramientas, rodamientos, resortes y rápidos*	< 1500
	P5	P5.1 Fundición de acero	
M	M1	M1.1 Aceros inoxidables, austeníticos	< 700
		M1.2 Aceros inoxidables, ferríticos/austeníticos (dúplex)	< 1000
K	K1	K1.1 Hierro fundido con grafito laminar (fundición gris), GJL	< 300
		K2.1 Hierro fundido con grafito esferoidal, GJS	< 500
	K2	K2.2 Hierro fundido con grafito esferoidal, GJS	≤ 800
		K2.3 Hierro fundido con grafito esferoidal, GJS	> 800
	K3	K3.1 Hierro fundido con grafito vermicular, GJV; fundición maleable, GJM	< 500
		K3.2 Hierro fundido con grafito vermicular, GJV; fundición maleable, GJM	> 500

MEGA-Drill-Hardened | SCD141

Grupo de arranque de vi-rutas de Mapal*		Material	Rigidez/dureza [N/mm ²] [HRC]
H	H1	H1.1 Acero templado/fundición de acero	< 44
		H1.2 Acero templado/fundición de acero	< 55
	H2	H2.1 Acero templado/fundición de acero	< 60
		H2.2 Acero templado/fundición de acero	< 65
		H2.3 Acero templado/fundición de acero	< 68

* Grupos de mecanizado MAPAL

** Si los componentes de aleación de Cr, Mo, Ni, V, W suman > 8 %, elegir el siguiente grupo de mecanizado MAPAL superior.

	Velocidad de corte v_c [m/min]				Avance f [mm] con diámetro de broca					
	Refrigeración interna	Refrigeración exterior	MMS	Aire	4,00	5,50	7,50	10,50	14,50	20,00
	110	100	100		0,10	0,13	0,17	0,22	0,28	0,33
	100	85	85		0,12	0,16	0,21	0,27	0,34	0,41
	110	95	95		0,11	0,15	0,20	0,26	0,33	0,38
	75	65	65		0,10	0,13	0,16	0,21	0,26	0,30
	85	70	70		0,10	0,14	0,18	0,23	0,29	0,35
	65	60	60		0,09	0,12	0,15	0,19	0,24	0,28
	65	50	55		0,07	0,09	0,12	0,15	0,19	0,22
	110	95	95		0,11	0,15	0,20	0,26	0,33	0,38
	130	95	95	95	0,13	0,19	0,26	0,35	0,45	0,54
	175	110	130	130	0,13	0,18	0,25	0,33	0,42	0,50
	110	85	85		0,12	0,16	0,22	0,28	0,36	0,43
	65	45	55		0,09	0,12	0,15	0,19	0,24	0,28
	100	90	90		0,13	0,18	0,23	0,31	0,39	0,46
	90	75	75		0,11	0,15	0,19	0,25	0,31	0,36

	Velocidad de corte v_c [m/min]				Avance f [mm] con diámetro de broca					
	Refrigeración interna	Refrigeración exterior	MMS	Aire	4,00	5,50	7,50	10,50	14,50	20,00
	80	70	70		0,04	0,04	0,05	0,06	0,07	0,08
	70	60	60		0,04	0,05	0,06	0,07	0,08	0,10
	80	70	70		0,04	0,05	0,06	0,07	0,08	0,09
	55	50	50		0,04	0,05	0,05	0,06	0,07	0,08
	60	50	50		0,04	0,04	0,05	0,06	0,07	0,08
	50	45	45		0,04	0,04	0,04	0,05	0,06	0,07
	50	35	40		0,03	0,04	0,04	0,05	0,05	0,06
	80	70	70		0,04	0,05	0,06	0,07	0,08	0,09
	40	25	25		0,03	0,03	0,03	0,04	0,05	0,06
	95	70	70	70	0,03	0,04	0,05	0,06	0,08	0,11
	130	80	95	95	0,04	0,05	0,06	0,07	0,09	0,11
	80	60	60		0,04	0,05	0,05	0,07	0,08	0,10
	70	65	65		0,04	0,05	0,06	0,07	0,09	0,11
	65	55	55		0,04	0,05	0,06	0,07	0,08	0,09

	Velocidad de corte v_c [m/min]				Avance f [mm] con diámetro de broca					
	Refrigeración interna	Refrigeración exterior	MMS	Aire	2,50	3,62	5,25	7,61	11,04	16,00
	80	80	80		0,07	0,09	0,11	0,02	0,19	0,20
	30	30	30		0,05	0,06	0,08	0,10	0,13	0,16
		30	30		0,04	0,05	0,07	0,09	0,11	0,13
		20	20		0,03	0,04	0,05	0,06	0,08	0,09
		15	15		0,03	0,04	0,05	0,06	0,08	0,09

Los valores de corte indicados son de referencia.

Los datos óptimos para cada situación de mecanizado deben determinarse mediante ensayos o durante el propio proceso de mecanizado.

Recomendación de valores de corte para brocas fabricadas por completo en metal duro

Avance y velocidad de corte

Tritan-Drill-Steel | SCD661

Grupo de arranque de vi-rutas de Mapal*		Material	Rigidez/dureza [N/mm ²] [HRC]
P	P1	P1.1 Aceros de construcción, para tornos automáticos, de cementación y revenidos, no aleados	< 700
		P1.2 Aceros de construcción, para tornos automáticos, de cementación y revenidos, no aleados	< 1200
	P2	P2.1 Aceros nitrurados, de cementación y aceros revenidos, aleados	< 900
		P2.2 Aceros nitrurados, de cementación y aceros revenidos, aleados	< 1400
	P3	P3.1 Aceros para herramientas, rodamientos, resortes y rápidos**	< 800
		P3.2 Aceros para herramientas, rodamientos, resortes y rápidos**	< 1000
		P3.3 Aceros para herramientas, rodamientos, resortes y rápidos**	< 1500
	P5	P5.1 Fundición de acero	
M	M1.1 Aceros inoxidables, austeníticos	< 700	
	M1.2 Aceros inoxidables, ferríticos/austeníticos (dúplex)	< 1000	
K	K1	K1.1 Hierro fundido con grafito laminar (fundición gris), GJL	< 300
		K2.1 Hierro fundido con grafito esferoidal, GJS	< 500
	K2	K2.2 Hierro fundido con grafito esferoidal, GJS	≤ 800
		K2.3 Hierro fundido con grafito esferoidal, GJS	> 800
	K3	K3.1 Hierro fundido con grafito vermicular, GJV; fundición maleable, GJM	< 500
		K3.2 Hierro fundido con grafito vermicular, GJV; fundición maleable, GJM	> 500

MEGA-Speed-Drill-Steel | SCD621

Grupo de arranque de vi-rutas de Mapal*		Material	Rigidez/dureza [N/mm ²] [HRC]
P	P1	P1.1 Aceros de construcción, para tornos automáticos, de cementación y revenidos, no aleados	< 700
		P1.2 Aceros de construcción, para tornos automáticos, de cementación y revenidos, no aleados	< 1200
	P2	P2.1 Aceros nitrurados, de cementación y aceros revenidos, aleados	< 900
		P2.2 Aceros nitrurados, de cementación y aceros revenidos, aleados	< 1400
	P3	P3.1 Aceros para herramientas, rodamientos, resortes y rápidos**	< 800
		P3.2 Aceros para herramientas, rodamientos, resortes y rápidos**	< 1000
		P3.3 Aceros para herramientas, rodamientos, resortes y rápidos**	< 1500
	P4	P4.1 Aceros inoxidables, ferríticos y martensíticos	
	P5	P5.1 Fundición de acero	
	P6	P6.1 Fundición de acero inoxidable, ferrítica y martensítica	
M	M1.1 Aceros inoxidables, austeníticos	< 700	
	M1.2 Aceros inoxidables, ferríticos/austeníticos (dúplex)	< 1000	
	M2.1 Fundición de acero inoxidable, austenítica	< 700	
	M3.1 Fundición de acero inoxidable, ferrítica/austenítica (dúplex)	< 1000	
K	K1	K1.1 Hierro fundido con grafito laminar (fundición gris), GJL	< 300
		K2.1 Hierro fundido con grafito esferoidal, GJS	< 500
	K2	K2.2 Hierro fundido con grafito esferoidal, GJS	≤ 800
		K2.3 Hierro fundido con grafito esferoidal, GJS	> 800
	K3	K3.1 Hierro fundido con grafito vermicular, GJV; fundición maleable, GJM	< 500
		K3.2 Hierro fundido con grafito vermicular, GJV; fundición maleable, GJM	> 500

* Grupos de mecanizado MAPAL

** Si los componentes de aleación de Cr, Mo, Ni, V, W suman > 8 %, elegir el siguiente grupo de mecanizado MAPAL superior.

	Velocidad de corte v_c [m/min]				Avance f [mm] con diámetro de broca					
	Refrigeración interna	Refrigeración exterior	MMS	Aire	4,00	5,50	7,50	10,50	14,50	20,00
	115	105	105		0,24	0,30	0,37	0,46	0,56	0,65
	105	85	85		0,30	0,37	0,46	0,58	0,70	0,81
	115	100	100		0,28	0,35	0,44	0,55	0,66	0,77
	80	70	70		0,24	0,29	0,36	0,44	0,53	0,61
	85	75	75		0,25	0,31	0,39	0,49	0,60	0,69
	70	65	65		0,21	0,26	0,33	0,41	0,49	0,56
	70	50	60		0,18	0,21	0,26	0,32	0,38	0,43
	115	100	100		0,28	0,35	0,44	0,55	0,66	0,77
	55	35	35		0,11	0,14	0,18	0,22	0,27	0,31
	140	100	100	100	0,34	0,45	0,58	0,75	0,92	1,08
	185	115	140	140	0,34	0,43	0,55	0,70	0,85	1,00
	115	85	85		0,30	0,38	0,48	0,61	0,74	0,86
	70	45	60		0,16	0,20	0,25	0,31	0,38	0,44
	105	90	90		0,32	0,41	0,52	0,65	0,79	0,92
	90	80	80		0,27	0,34	0,42	0,52	0,63	0,73

	Velocidad de corte v_c [m/min]				Avance f [mm] con diámetro de broca					
	Refrigeración interna	Refrigeración exterior	MMS	Aire	3,00	4,50	6,50	9,50	14,00	20,00
	170	155	155		0,13	0,17	0,22	0,29	0,36	0,43
	155	130	130		0,16	0,21	0,28	0,36	0,45	0,54
	170	145	145		0,15	0,20	0,26	0,34	0,43	0,51
	120	100	100		0,13	0,17	0,21	0,27	0,34	0,40
	130	110	110		0,13	0,18	0,23	0,30	0,39	0,46
	100	95	95		0,12	0,15	0,20	0,25	0,32	0,37
	100	75	85		0,10	0,12	0,16	0,20	0,25	0,29
	100	75	85		0,09	0,12	0,16	0,20	0,25	0,30
	170	145	145		0,15	0,20	0,26	0,34	0,43	0,51
	100	75	85		0,09	0,12	0,16	0,20	0,25	0,30
	65	40	40		0,07	0,09	0,12	0,15	0,19	0,23
	60	35	35		0,06	0,08	0,10	0,13	0,17	0,20
	65	40	40		0,07	0,09	0,12	0,15	0,19	0,23
	60	35	35		0,06	0,08	0,10	0,13	0,17	0,20
	150	105	105	105	0,14	0,21	0,28	0,38	0,49	0,59
	200	125	150	150	0,14	0,20	0,27	0,36	0,46	0,54
	125	95	95		0,13	0,18	0,24	0,31	0,39	0,47
	75	50	65		0,09	0,12	0,15	0,19	0,24	0,28
	115	100	100		0,14	0,19	0,25	0,33	0,42	0,50
	100	90	90		0,12	0,16	0,21	0,27	0,34	0,40

Los valores de corte indicados son de referencia.

Los datos óptimos para cada situación de mecanizado deben determinarse mediante ensayos o durante el propio proceso de mecanizado.

Recomendación de valores de corte para brocas fabricadas por completo en metal duro

Avance y velocidad de corte

MEGA-180°-Drill | SCD231

Grupo de arranque de virutas de Mapal*		Material	Rigidez/dureza [N/mm ²] [HRC]
P	P1	P1.1 Aceros de construcción, para tornos automáticos, de cementación y revenidos, no aleados	< 700
		P1.2 Aceros de construcción, para tornos automáticos, de cementación y revenidos, no aleados	< 1200
	P2	P2.1 Aceros nitrurados, de cementación y aceros revenidos, aleados	< 900
		P2.2 Aceros nitrurados, de cementación y aceros revenidos, aleados	< 1400
	P3	P3.1 Aceros para herramientas, rodamientos, resortes y rápidos**	< 800
		P3.2 Aceros para herramientas, rodamientos, resortes y rápidos**	< 1000
		P3.3 Aceros para herramientas, rodamientos, resortes y rápidos**	< 1500
	P5	P5.1 Fundición de acero	
K	K1	K1.1 Hierro fundido con grafito laminar (fundición gris), GJL	< 300
		K2.1 Hierro fundido con grafito esferoidal, GJS	< 500
	K2	K2.2 Hierro fundido con grafito esferoidal, GJS	≤ 800
		K2.3 Hierro fundido con grafito esferoidal, GJS	> 800
	K3	K3.1 Hierro fundido con grafito vermicular, GJV; fundición maleable, GJM	< 500
		K3.2 Hierro fundido con grafito vermicular, GJV; fundición maleable, GJM	> 500

ECU-Drill-Steel | SCD360, 361

Grupo de arranque de virutas de Mapal*		Material	Rigidez/dureza [N/mm ²] [HRC]
P	P1	P1.1 Aceros de construcción, para tornos automáticos, de cementación y revenidos, no aleados	< 700
		P1.2 Aceros de construcción, para tornos automáticos, de cementación y revenidos, no aleados	< 1200
	P2	P2.1 Aceros nitrurados, de cementación y aceros revenidos, aleados	< 900
		P2.2 Aceros nitrurados, de cementación y aceros revenidos, aleados	< 1400
	P3	P3.1 Aceros para herramientas, rodamientos, resortes y rápidos**	< 800
		P3.2 Aceros para herramientas, rodamientos, resortes y rápidos**	< 1000
		P3.3 Aceros para herramientas, rodamientos, resortes y rápidos**	< 1500
	P4	P4.1 Aceros inoxidables, ferríticos y martensíticos	
	P5	P5.1 Fundición de acero	
	P6	P6.1 Fundición de acero inoxidable, ferrítica y martensítica	
K	K1	K1.1 Hierro fundido con grafito laminar (fundición gris), GJL	< 300
		K2.1 Hierro fundido con grafito esferoidal, GJS	< 500
	K2	K2.2 Hierro fundido con grafito esferoidal, GJS	≤ 800
		K2.3 Hierro fundido con grafito esferoidal, GJS	> 800
	K3	K3.1 Hierro fundido con grafito vermicular, GJV; fundición maleable, GJM	< 500
		K3.2 Hierro fundido con grafito vermicular, GJV; fundición maleable, GJM	> 500

* Grupos de mecanizado MAPAL

** Si los componentes de aleación de Cr, Mo, Ni, V, W suman > 8 %, elegir el siguiente grupo de mecanizado MAPAL superior.

	Velocidad de corte v_c [m/min]				Avance f [mm] con diámetro de broca					
	Refrigeración interna	Refrigeración exterior	MMS	Aire	3,00	4,50	6,50	9,50	14,00	20,00
	80	70	70		0,07	0,09	0,12	0,16	0,20	0,24
	70	60	60		0,09	0,12	0,15	0,20	0,25	0,30
	80	70	70		0,08	0,11	0,14	0,19	0,24	0,28
	55	50	50		0,07	0,09	0,12	0,15	0,19	0,22
	60	50	50		0,07	0,10	0,13	0,17	0,21	0,25
	50	45	45		0,06	0,08	0,11	0,14	0,17	0,21
	50	35	40		0,05	0,07	0,09	0,11	0,14	0,16
	80	70	70		0,08	0,11	0,14	0,19	0,24	0,28
	95	70	70	70	0,09	0,14	0,19	0,25	0,33	0,39
	130	80	95	95	0,10	0,13	0,18	0,24	0,30	0,36
	80	60	60		0,09	0,12	0,16	0,21	0,26	0,31
	50	30	40		0,06	0,08	0,11	0,14	0,17	0,21
	70	65	65		0,09	0,13	0,17	0,22	0,28	0,33
	65	55	55		0,08	0,11	0,14	0,18	0,22	0,26

	Velocidad de corte v_c [m/min]				Avance f [mm] con diámetro de broca					
	Refrigeración interna	Refrigeración exterior	MMS	Aire	1,00	1,82	3,31	6,03	10,99	20,00
	75	70	70		0,04	0,06	0,08	0,13	0,20	0,27
	70	55	55		0,05	0,07	0,11	0,16	0,24	0,33
	75	65	65		0,05	0,07	0,10	0,15	0,23	0,31
	55	45	45		0,05	0,06	0,09	0,13	0,18	0,25
	55	50	50		0,04	0,06	0,09	0,14	0,21	0,28
	45	40	40		0,04	0,05	0,08	0,12	0,17	0,23
	45	35	40		0,04	0,05	0,06	0,09	0,13	0,18
	45	35	40		0,03	0,04	0,06	0,09	0,14	0,19
	75	65	65		0,05	0,07	0,10	0,15	0,23	0,31
	45	35	40		0,03	0,04	0,06	0,09	0,14	0,19
	80	60	60	60	0,04	0,07	0,12	0,20	0,32	0,44
	110	70	80	80	0,05	0,07	0,12	0,19	0,30	0,41
	70	50	50		0,04	0,07	0,11	0,17	0,26	0,35
	40	25	35		0,04	0,05	0,08	0,12	0,17	0,23
	60	55	55		0,05	0,07	0,11	0,18	0,27	0,38
	55	50	50		0,05	0,07	0,10	0,15	0,22	0,30

Los valores de corte indicados son de referencia.

Los datos óptimos para cada situación de mecanizado deben determinarse mediante ensayos o durante el propio proceso de mecanizado.

Recomendación de valores de corte para brocas fabricadas por completo en metal duro

Avance y velocidad de corte

MEGA-Drill-Inox | SCD120, 121

Grupo de arranque de virutas de Mapal*		Material	Rigidez/dureza [N/mm ²] [HRC]
P	P1	P1.1 Aceros de construcción, para tornos automáticos, de cementación y revenidos, no aleados	< 700
		P1.2 Aceros de construcción, para tornos automáticos, de cementación y revenidos, no aleados	< 1200
	P2	P2.1 Aceros nitrurados, de cementación y aceros revenidos, aleados	< 900
		P2.2 Aceros nitrurados, de cementación y aceros revenidos, aleados	< 1400
	P3	P3.1 Aceros para herramientas, rodamientos, resortes y rápidos**	< 800
		P3.2 Aceros para herramientas, rodamientos, resortes y rápidos**	< 1000
		P3.3 Aceros para herramientas, rodamientos, resortes y rápidos**	< 1500
	P4	P4.1 Aceros inoxidables, ferríticos y martensíticos	
	P5	P5.1 Fundición de acero	
	P6	P6.1 Fundición de acero inoxidable, ferrítica y martensítica	
M	M1	M1.1 Aceros inoxidables, austeníticos	< 700
		M1.2 Aceros inoxidables, ferríticos/austeníticos (dúplex)	< 1000
	M2	M2.1 Fundición de acero inoxidable, austenítica	< 700
		M3.1 Fundición de acero inoxidable, ferrítica/austenítica (dúplex)	< 1000
K	K1	K1.1 Hierro fundido con grafito laminar (fundición gris), GJL	< 300
		K2.1 Hierro fundido con grafito esferoidal, GJS	< 500
		K2.2 Hierro fundido con grafito esferoidal, GJS	≤ 800
	K3	K2.3 Hierro fundido con grafito esferoidal, GJS	> 800
		K3.1 Hierro fundido con grafito vermicular, GJV; fundición maleable, GJM	< 500
		K3.2 Hierro fundido con grafito vermicular, GJV; fundición maleable, GJM	> 500
N	N2	N2.1 Cobre, no aleado y de baja aleación	< 300
		N2.2 Cobre, aleado	> 300
	N2.3 Latón, bronce, fundición roja	< 1200	

MEGA-Speed-Drill-Inox | SCD411

Grupo de arranque de virutas de Mapal*		Material	Rigidez/dureza [N/mm ²] [HRC]
P	P1	P1.1 Aceros de construcción, para tornos automáticos, de cementación y revenidos, no aleados	< 700
		P1.2 Aceros de construcción, para tornos automáticos, de cementación y revenidos, no aleados	< 1200
	P2	P2.1 Aceros nitrurados, de cementación y aceros revenidos, aleados	< 900
		P2.2 Aceros nitrurados, de cementación y aceros revenidos, aleados	< 1400
	P3	P3.1 Aceros para herramientas, rodamientos, resortes y rápidos**	< 800
		P3.2 Aceros para herramientas, rodamientos, resortes y rápidos**	< 1000
		P3.3 Aceros para herramientas, rodamientos, resortes y rápidos**	< 1500
	P4	P4.1 Aceros inoxidables, ferríticos y martensíticos	
	P5	P5.1 Fundición de acero	
	P6	P6.1 Fundición de acero inoxidable, ferrítica y martensítica	
M	M1	M1.1 Aceros inoxidables, austeníticos	< 700
		M1.2 Aceros inoxidables, ferríticos/austeníticos (dúplex)	< 1000
	M2	M2.1 Fundición de acero inoxidable, austenítica	< 700
		M3.1 Fundición de acero inoxidable, ferrítica/austenítica (dúplex)	< 1000
S	S1	S1.1 Titanio, aleaciones de titanio	< 400
		S2.1 Titanio, aleaciones de titanio	< 1200
		S2.2 Titanio, aleaciones de titanio	> 1200
	S3	S3.1 Níquel, no aleado y aleado	< 900
		S3.2 Níquel, no aleado y aleado	> 900
	S4	S4.1 Superaleación de gran resistencia al calor basada en Ni, Co y Fe	
	S5	S5.1 Aleaciones de wolframio y molibdeno	

* Grupos de mecanizado MAPAL

** Si los componentes de aleación de Cr, Mo, Ni, V, W suman > 8 %, elegir el siguiente grupo de mecanizado MAPAL superior.

	Velocidad de corte v_c [m/min]				Avance f [mm] con diámetro de broca					
	Refrigeración interna	Refrigeración exterior	MMS	Aire	3,00	4,50	6,50	9,50	14,00	20,00
	100	90	90		0,07	0,09	0,12	0,16	0,20	0,24
	90	75	75		0,09	0,12	0,15	0,20	0,25	0,30
	100	85	85		0,08	0,11	0,14	0,19	0,24	0,28
	70	60	60		0,07	0,09	0,12	0,15	0,19	0,22
	75	65	65		0,07	0,10	0,13	0,17	0,21	0,25
	60	55	55		0,06	0,08	0,11	0,14	0,17	0,21
	60	45	50		0,05	0,07	0,09	0,11	0,14	0,16
	60	45	50		0,05	0,07	0,09	0,11	0,14	0,17
	100	85	85		0,08	0,11	0,14	0,19	0,24	0,28
	60	45	50		0,05	0,07	0,09	0,11	0,14	0,17
	55	35	35		0,06	0,08	0,11	0,14	0,18	0,21
	50	30	30		0,05	0,07	0,09	0,12	0,15	0,18
	55	35	35		0,06	0,08	0,11	0,14	0,18	0,21
	50	30	30		0,05	0,07	0,09	0,12	0,15	0,18
	120	85	85	85	0,12	0,17	0,24	0,32	0,41	0,49
	160	100	120	120	0,12	0,17	0,22	0,30	0,38	0,45
	100	75	75		0,11	0,15	0,20	0,26	0,33	0,39
	60	40	50		0,08	0,10	0,13	0,17	0,22	0,26
	90	80	80		0,12	0,16	0,21	0,28	0,35	0,42
	80	70	70		0,10	0,13	0,17	0,22	0,28	0,33
	140	100			0,09	0,12	0,15	0,20	0,25	0,30
	120	90			0,11	0,15	0,20	0,26	0,33	0,39
	200	160	160	120	0,12	0,17	0,24	0,32	0,41	0,49

	Velocidad de corte v_c [m/min]				Avance f [mm] con diámetro de broca					
	Refrigeración interna	Refrigeración exterior	MMS	Aire	3,00	4,50	6,50	9,50	14,00	20,00
	150	135	135		0,09	0,12	0,15	0,20	0,25	0,30
	135	115	115		0,11	0,15	0,19	0,25	0,31	0,37
	150	130	130		0,10	0,14	0,18	0,23	0,30	0,35
	105	90	90		0,09	0,12	0,15	0,19	0,24	0,28
	115	100	100		0,09	0,12	0,16	0,21	0,27	0,32
	90	85	85		0,08	0,10	0,13	0,17	0,22	0,26
	90	70	75		0,07	0,09	0,11	0,14	0,17	0,20
	70	55	60		0,06	0,08	0,11	0,14	0,18	0,21
	150	130	130		0,10	0,14	0,18	0,23	0,30	0,35
	70	55	60		0,06	0,08	0,11	0,14	0,18	0,21
	80	50	50		0,08	0,10	0,13	0,17	0,22	0,26
	75	45	45		0,07	0,09	0,11	0,15	0,19	0,22
	80	50	50		0,08	0,10	0,13	0,17	0,22	0,26
	75	45	45		0,07	0,09	0,11	0,15	0,19	0,22
					0,07	0,10	0,13	0,17	0,21	0,25
	35	25			0,06	0,08	0,11	0,14	0,18	0,21
	30	20			0,05	0,07	0,09	0,12	0,15	0,18
	25	20			0,04	0,06	0,07	0,10	0,12	0,14
	20	10			0,05	0,07	0,09	0,12	0,15	0,18
	20	10			0,04	0,06	0,07	0,10	0,12	0,14
	20	10			0,04	0,06	0,07	0,10	0,12	0,14

Los valores de corte indicados son de referencia.

Los datos óptimos para cada situación de mecanizado deben determinarse mediante ensayos o durante el propio proceso de mecanizado.

Recomendación de valores de corte para brocas fabricadas por completo en metal duro

Avance y velocidad de corte

MEGA-Speed-Drill-Iron | SCD421

Grupo de arranque de vi-rutas de Mapal*	Material	Rigidez/dureza [N/mm ²] [HRC]
K	K1.1 Hierro fundido con grafito laminar (fundición gris), GJL	< 300
	K2.1 Hierro fundido con grafito esferoidal, GJS	< 500
	K2.2 Hierro fundido con grafito esferoidal, GJS	≤ 800
	K2.3 Hierro fundido con grafito esferoidal, GJS	> 800
	K3.1 Hierro fundido con grafito vermicular, GJV; fundición maleable, GJM	< 500
	K3.2 Hierro fundido con grafito vermicular, GJV; fundición maleable, GJM	> 500

MEGA-Drill-Alu | SCD131

Grupo de arranque de vi-rutas de Mapal*	Material	Rigidez/dureza [N/mm ²] [HRC]
N1	N1.1 Aluminio, aleado y no aleado < 3 % Si	
	N1.2 Aluminio, aleado ≤ 7 % Si	
	N1.3 Aluminio, aleado > 7-12 % Si	
	N1.4 Aluminio, aleado > 12 % Si	
N2	N2.1 Cobre, no aleado y de baja aleación	< 300
	N2.2 Cobre, aleado	> 300
	N2.3 Latón, bronce, fundición roja	< 1200

MEGA-Drill-Composite-MD | SCD250

Grupo de arranque de vi-rutas de Mapal*	Material	Rigidez/dureza [N/mm ²] [HRC]
N3	N3.1 Grafito, > 8 μm	
	N3.2 Grafito, ≤ 8 μm	
C1	C1.1 Matriz de plástico, reforzada con fibras de aramida (AFK)	
	C1.2 Matriz de plástico (termoestable), CFK/GFK	
	C1.3 Matriz de plástico (termoplástico), CFK/GFK	
C2	C2.1 Matriz de carbono, reforzada con fibras de carbono (CFC)	
	C3.1 Matriz metálica (MMC)	
C4	C4.1 Construcción tipo sándwich, núcleo de panal (nido de abeja)	
	C4.2 Construcción tipo sándwich, núcleo de espuma	

MEGA-Drill-Composite-UDX | SCD270, 271

Grupo de arranque de vi-rutas de Mapal*	Material	Rigidez/dureza [N/mm ²] [HRC]
C1	C1.1 Matriz de plástico, reforzada con fibras de aramida (AFK)	
	C1.2 Matriz de plástico (termoestable), CFK/GFK	
	C1.3 Matriz de plástico (termoplástico), CFK/GFK	
	C2.1 Matriz de carbono, reforzada con fibras de carbono (CFC)	

* Grupos de mecanizado MAPAL

	Velocidad de corte v_c [m/min]				Avance f [mm] con diámetro de broca					
	Refrigeración interna	Refrigeración exterior	MMS	Aire	3,00	4,50	6,50	9,50	14,00	20,00
	170	120	120	120	0,15	0,21	0,29	0,40	0,51	0,61
	225	140	170	170	0,15	0,21	0,28	0,37	0,48	0,57
	140	105	105		0,14	0,19	0,25	0,32	0,41	0,49
	85	55	70		0,10	0,13	0,17	0,22	0,27	0,32
	125	110	110		0,15	0,20	0,26	0,35	0,44	0,52
	110	100	100		0,13	0,17	0,22	0,28	0,35	0,41

	Velocidad de corte v_c [m/min]				Avance f [mm] con diámetro de broca					
	Refrigeración interna	Refrigeración exterior	MMS	Aire	3,00	4,50	6,50	9,50	14,00	20,00
	300	200	250		0,09	0,12	0,15	0,20	0,25	0,30
	250	180	200		0,11	0,15	0,20	0,26	0,33	0,39
	220	150	180		0,11	0,15	0,20	0,26	0,33	0,39
	180	120	150		0,11	0,15	0,20	0,26	0,33	0,39
	140	100			0,09	0,12	0,15	0,20	0,25	0,30
	120	90			0,11	0,15	0,20	0,26	0,33	0,39
	200	160	160	120	0,09	0,14	0,19	0,25	0,33	0,39

	Velocidad de corte v_c [m/min]				Avance f [mm] con diámetro de broca					
	Refrigeración interna	Refrigeración exterior	MMS	Aire	3,00	4,00	5,50	7,50	10,00	12,00
				200	0,07	0,09	0,11	0,14	0,16	0,18
				200	0,07	0,09	0,11	0,14	0,16	0,18
				90	0,04	0,04	0,05	0,06	0,07	0,08
				75	0,04	0,04	0,05	0,06	0,07	0,08
				75	0,04	0,04	0,05	0,06	0,07	0,08
				400	0,04	0,04	0,05	0,06	0,07	0,08
				400	0,04	0,04	0,05	0,06	0,07	0,08

	Velocidad de corte v_c [m/min]				Avance f [mm] con diámetro de broca					
	Refrigeración interna	Refrigeración exterior	MMS	Aire	3,00	4,00	5,50	7,50	10,00	12,00
				90	0,04	0,04	0,05	0,06	0,07	0,08
				75	0,04	0,04	0,05	0,06	0,07	0,08
				75	0,04	0,04	0,05	0,06	0,07	0,08

Los valores de corte indicados son de referencia.

Los datos óptimos para cada situación de mecanizado deben determinarse mediante ensayos o durante el propio proceso de mecanizado.

Recomendación de valores de corte para brocas fabricadas por completo en metal duro

Avance y velocidad de corte

MEGA-180°-Drill-Alu | SCD241

Grupo de arranque de virutas de Mapal*		Material	Rigidez/dureza [N/mm ²] [HRC]
N	N1	N1.1 Aluminio, aleado y no aleado < 3 % Si	
		N1.2 Aluminio, aleado ≤ 7 % Si	
		N1.3 Aluminio, aleado > 7-12 % Si	
		N1.4 Aluminio, aleado > 12 % Si	
N	N2	N2.1 Cobre, no aleado y de baja aleación	< 300
		N2.2 Cobre, aleado	> 300
		N2.3 Latón, bronce, fundición roja	< 1200

ECU-G-Drill | SCD211

Grupo de arranque de virutas de Mapal*		Material	Rigidez/dureza [N/mm ²] [HRC]
K	K1	K1.1 Hierro fundido con grafito laminar (fundición gris), GJL	< 300
		K2.1 Hierro fundido con grafito esferoidal, GJS	< 500
		K2.2 Hierro fundido con grafito esferoidal, GJS	≤ 800
		K2.3 Hierro fundido con grafito esferoidal, GJS	> 800
N	N1	N1.1 Aluminio, aleado y no aleado < 3 % Si	
		N1.2 Aluminio, aleado ≤ 7 % Si	
		N1.3 Aluminio, aleado > 7-12 % Si	
		N1.4 Aluminio, aleado > 12 % Si	
N	N2	N2.1 Cobre, no aleado y de baja aleación	< 300
		N2.2 Cobre, aleado	> 300
		N2.3 Latón, bronce, fundición roja	< 1200

* Grupos de mecanizado MAPAL

	Velocidad de corte v_c [m/min]				Avance f [mm] con diámetro de broca					
	Refrigeración interna	Refrigeración exterior	MMS	Aire	3,00	4,50	6,50	9,50	14,00	20,00
	240	160	200		0,07	0,09	0,12	0,16	0,20	0,24
	200	145	160		0,09	0,12	0,16	0,21	0,26	0,31
	175	120	145		0,09	0,12	0,16	0,21	0,26	0,31
	145	95	120		0,09	0,12	0,16	0,21	0,26	0,31
	110	80			0,07	0,09	0,12	0,16	0,20	0,24
	95	70			0,09	0,12	0,16	0,21	0,26	0,31
	160	130	130	95	0,09	0,14	0,19	0,25	0,33	0,39

	Velocidad de corte v_c [m/min]				Avance f [mm] con diámetro de broca					
	Refrigeración interna	Refrigeración exterior	MMS	Aire	3,00	4,50	6,50	9,50	14,00	20,00
	90	65	65	65	0,08	0,12	0,16	0,22	0,29	0,34
	120	75	90	90	0,08	0,12	0,16	0,21	0,27	0,32
	75	55	55		0,08	0,10	0,14	0,18	0,23	0,27
	215	155	170		0,08	0,10	0,14	0,18	0,23	0,27
	185	130	155		0,08	0,10	0,14	0,18	0,23	0,27
	155	100	130		0,08	0,10	0,14	0,18	0,23	0,27
	160	130	130	95	0,08	0,12	0,16	0,22	0,29	0,34

Los valores de corte indicados son de referencia.

Los datos óptimos para cada situación de mecanizado deben determinarse mediante ensayos o durante el propio proceso de mecanizado.





BARRENADO EN SOLIDO CON SISTEMA DE CABEZAL INTERCAMBIABLE

Brocas de placas de corte QTD

Tecnología	184
Tipo 01 – Steel	186
Tipo 05 – Steel-Pyramid	188
Tipo 10 – Uni, forma EK	190
Tipo 02 – Inox	191
Tipo 04 – Iron	193
Tipo 03 – Alu	194
Soportes para placas de corte QTS	195
Accesorios y refacciones	199
Recomendación de valores de corte	200

Broca de cabezal intercambiable TTD

Tecnología	204
Tipo 01 – Uni-Plus	206
Tipo 04 – Steel	207
Tipo 02 – Inox	209
Tipo 05 – Iron	211
Tipo 03 – Alu	212
Portaherramientas para cabezal intercambiable TTS	213
Accesorios y refacciones	222
Recomendación de valores de corte	224

Broca de cabezal intercambiable TTD-Tritan

Tecnología	228
Tipo 01 – Uni	230
Portaherramientas para cabezal intercambiable TTS-300	231
Accesorios y refacciones	234
Recomendación de valores de corte	236



BROCAS DE PLACAS DE CORTE QTD

Alojamiento de insertos estable, fácil sistema de sujeción

Con la más moderna tecnología de fabricación en el rango de diámetro de 8 a 50 mm

Las brocas de placas de corte QTD para el rango de diámetros de medio a superior se caracterizan por una excelente formación de viruta y una retirada de virutas segura. Con posibilidad de cambio múltiple de las placas de corte de cada soporte, ya que el portaherramientas básico no se erosiona. La estructura del sistema de sujeción para la placa de corte es especialmente sencilla y, al mismo tiempo, efectiva. Consta de un tornillo que se atornilla transversalmente a través de la placa de corte y sujeta la placa de forma estable bajo tensión previa en el alojamiento prismático. La placa de corte se sujeta de forma especialmente estable en el alojamiento prismático, lo que hace posible unos elevados datos de corte y calidades de agujero.

La fabricación aditiva permite la ejecución óptima del canal de refrigeración y diámetros a partir de 9 mm

Para poder realizar también diámetros inferiores a 13 mm se utiliza la fabricación aditiva. Con este procedimiento pueden fabricarse cuerpos en el rango de diámetro de 8 a 13 mm con canales de refrigeración en espiral. En comparación con la conducción del refrigerante central con desviaciones, el QTD con canal en refrigeración logra un aumento del caudal de refrigerante del 100 %, especialmente debido a los perfiles de los canales de refrigeración que difieren de la forma circular.

Características detalladas de la herramienta



1 Mango según ISO 9766

2 Apoyo plano del mango

3 Línea característica para profundidad de taladrado máxima

4 Exposición dorsal
- Para una retirada de virutas óptima

5 Transmisión de fuerza óptima
- Mediante placa de corte integrada

6 Alojamiento de acero templado con mango cilíndrico

7 Sujeción estable TORX® PLUS

8 Asiento prismático de placas
- Para un centraje óptimo de la placa de corte

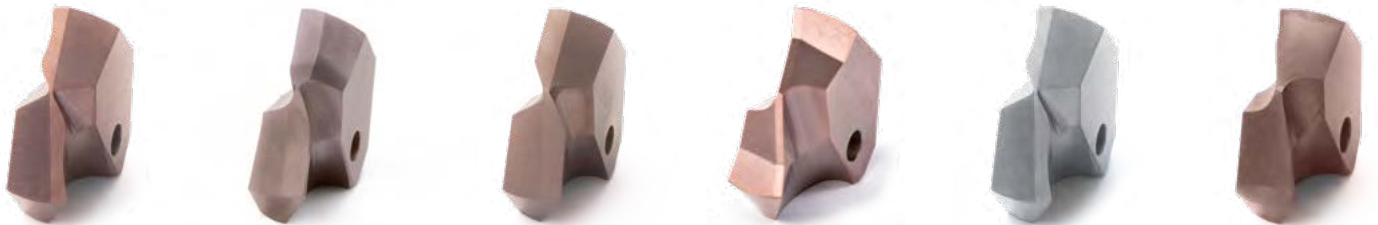

RESUMEN

- Alta disponibilidad en el almacén
- Rango de diámetro de 9 a 50 mm
- Programa de soportes 1,5 | 3 | 5 | 8 y 12xD
- Placas de corte para acero, acero inoxidable, aluminio y fundición
- Con refrigeración interna
- Tratamiento especial de las superficies
- Fácil manejo, cambio de las placas de corte en la máquina

CARACTERÍSTICAS DE RENDIMIENTO

- Mismo rendimiento que las brocas fabricadas íntegramente en metal duro
- Alta precisión de concentricidad
- Collar estable para absorber grandes fuerzas axiales
- Sujeción segura de la placa de corte mediante tornillo TORX® PLUS
- Sistema robusto

VENTAJAS

- Optimización de costes
- Máximo rendimiento
- Montaje de las placas de corte con protección a prueba de error
- Formación de viruta óptima en la placa de corte y retirada de virutas
- Un soporte para todas las geometrías de broca
- Posibilidad de muchos cambios de placas de corte por soporte, ya que no se erosiona el portaherramientas básico

Placas de corte QTD

De metal duro, suministro de refrigerante interior
Tipo 01 – Steel

Ejecución:

Diámetro de broca:	9,00 - 50,00 mm
Tolerancia del agujero:	≥ IT 10
Material de corte:	HP240
Número de insertos:	2
Número de bisel guía:	2
Ángulo de la punta:	135°

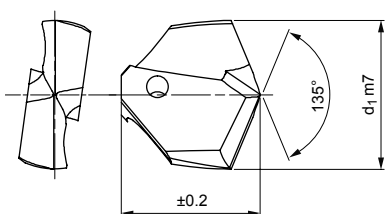

Serie preferente disponible en stock

d ₁ de 9,00 a 15,50			
d ₁ m7	Tamaño del soporte D	Especificación	Referencia
9,00	9	QTD-2F01-0900-HP240	30615635
9,50	9,5	QTD-2F01-0950-HP240	30615636
10,00	10	QTD-2F01-1000-HP240	30615638
10,20	10	QTD-2F01-1020-HP240	30646024
10,50	10,5	QTD-2F01-1050-HP240	30615639
10,70	10,5	QTD-2F01-1070-HP240	30615640
11,00	11	QTD-2F01-1100-HP240	30615641
11,50	11,5	QTD-2F01-1150-HP240	30615642
12,00	12	QTD-2F01-1200-HP240	30615644
12,50	12,5	QTD-2F01-1250-HP240	30615645
12,70	12,5	QTD-2F01-1270-HP240	30615646
12,80	12,5	QTD-2F01-1280-HP240	30646043
13,00	13	QTD-2F01-1300-HP240	30572990
13,10	13	QTD-2F01-1310-HP240	30646045
13,30	13	QTD-2F01-1330-HP240	30646047
13,40	13	QTD-2F01-1340-HP240	30646048
13,50	13,5	QTD-2F01-1350-HP240	30572991
13,80	13,5	QTD-2F01-1380-HP240	30646050
13,90	13,5	QTD-2F01-1390-HP240	30646051
14,00	14	QTD-2F01-1400-HP240	30572993
14,10	14	QTD-2F01-1410-HP240	30646052
14,20	14	QTD-2F01-1420-HP240	30646053
14,30	14	QTD-2F01-1430-HP240	30646055
14,50	14,5	QTD-2F01-1450-HP240	30572994
14,60	14,5	QTD-2F01-1460-HP240	30646057
14,70	14,5	QTD-2F01-1470-HP240	30572995
14,80	14,5	QTD-2F01-1480-HP240	30646058
14,90	14,5	QTD-2F01-1490-HP240	30646059
15,00	15	QTD-2F01-1500-HP240	30572997
15,10	15	QTD-2F01-1510-HP240	30646060
15,20	15	QTD-2F01-1520-HP240	30646061
15,25	15	QTD-2F01-1525-HP240	30572998
15,50	15	QTD-2F01-1550-HP240	30572999

d ₁ de 15,70 a 19,50			
d ₁ m7	Tamaño del soporte D	Especificación	Referencia
15,70	15	QTD-2F01-1570-HP240	30573000
15,80	15	QTD-2F01-1580-HP240	30646066
15,90	15	QTD-2F01-1590-HP240	30646068
16,00	16	QTD-2F01-1600-HP240	30573001
16,10	16	QTD-2F01-1610-HP240	30573003
16,20	16	QTD-2F01-1620-HP240	30646069
16,25	16	QTD-2F01-1625-HP240	30573004
16,30	16	QTD-2F01-1630-HP240	30610882
16,40	16	QTD-2F01-1640-HP240	30646071
16,50	16	QTD-2F01-1650-HP240	30573005
16,60	16	QTD-2F01-1660-HP240	30646072
16,70	16	QTD-2F01-1670-HP240	30573006
16,80	16	QTD-2F01-1680-HP240	30646074
16,90	16	QTD-2F01-1690-HP240	30646075
17,00	17	QTD-2F01-1700-HP240	30573009
17,10	17	QTD-2F01-1710-HP240	30646076
17,20	17	QTD-2F01-1720-HP240	30646077
17,30	17	QTD-2F01-1730-HP240	30646078
17,40	17	QTD-2F01-1740-HP240	30646079
17,50	17	QTD-2F01-1750-HP240	30573010
17,60	17	QTD-2F01-1760-HP240	30646081
17,70	17	QTD-2F01-1770-HP240	30573011
17,80	17	QTD-2F01-1780-HP240	30646082
17,90	17	QTD-2F01-1790-HP240	30646083
18,00	18	QTD-2F01-1800-HP240	30573012
18,10	18	QTD-2F01-1810-HP240	30646084
18,50	18	QTD-2F01-1850-HP240	30573014
18,60	18	QTD-2F01-1860-HP240	30646088
18,70	18	QTD-2F01-1870-HP240	30573015
18,80	18	QTD-2F01-1880-HP240	30646089
18,90	18	QTD-2F01-1890-HP240	30646090
19,00	19	QTD-2F01-1900-HP240	30573016
19,50	19	QTD-2F01-1905-HP240	30646091

Placas de corte QTD de metal duro, suministro de refrigerante interior – Tipo 01

d ₁ de 19,10 a 24,70				d ₁ de 24,75 a 42,60			
d ₁ m7	Tamaño del soporte D	Especificación	Referencia	d ₁ m7	Tamaño del soporte D	Especificación	Referencia
19,10	19	QTD-2F01-1910-HP240	30646092	24,75	24	QTD-2F01-2475-HP240	30573046
19,20	19	QTD-2F01-1920-HP240	30573017	24,80	24	QTD-2F01-2480-HP240	30660662
19,25	19	QTD-2F01-1925-HP240	30573018	25,00	25	QTD-2F01-2500-HP240	30573047
19,30	19	QTD-2F01-1930-HP240	30646094	25,40	25	QTD-2F01-2540-HP240	30573048
19,50	19	QTD-2F01-1950-HP240	30573020	25,50	25	QTD-2F01-2550-HP240	30573049
19,60	19	QTD-2F01-1960-HP240	30646095	25,70	25	QTD-2F01-2570-HP240	30573050
19,70	19	QTD-2F01-1970-HP240	30573021	25,80	25	QTD-2F01-2580-HP240	30584730
19,75	19	QTD-2F01-1975-HP240	30573022	26,00	26	QTD-2F01-2600-HP240	30573051
19,80	19	QTD-2F01-1980-HP240	30646096	26,50	26	QTD-2F01-2650-HP240	30573052
19,90	19	QTD-2F01-1990-HP240	30646097	27,00	27	QTD-2F01-2700-HP240	30573053
20,00	20	QTD-2F01-2000-HP240	30573023	27,50	27	QTD-2F01-2750-HP240	30573054
20,40	20	QTD-2F01-2040-HP240	30573024	27,75	27	QTD-2F01-2775-HP240	30573055
20,50	20	QTD-2F01-2050-HP240	30573025	28,00	28	QTD-2F01-2800-HP240	30573056
20,70	20	QTD-2F01-2070-HP240	30573026	28,50	28	QTD-2F01-2850-HP240	30573058
20,75	20	QTD-2F01-2075-HP240	30573027	29,00	29	QTD-2F01-2900-HP240	30573059
21,00	21	QTD-2F01-2100-HP240	30573028	29,50	29	QTD-2F01-2950-HP240	30573060
21,50	21	QTD-2F01-2150-HP240	30573029	29,80	29	QTD-2F01-2980-HP240	30728319
21,70	21	QTD-2F01-2170-HP240	30573030	30,00	30	QTD-2F01-3000-HP240	30573062
22,00	22	QTD-2F01-2200-HP240	30573031	30,25	30	QTD-2F01-3025-HP240	30573063
22,25	22	QTD-2F01-2225-HP240	30573032	30,50	30	QTD-2F01-3050-HP240	30573064
22,50	22	QTD-2F01-2250-HP240	30573034	31,00	31	QTD-2F01-3100-HP240	30573066
22,70	22	QTD-2F01-2270-HP240	30573035	31,50	31	QTD-2F01-3150-HP240	30573067
22,75	22	QTD-2F01-2275-HP240	30573036	32,00	32	QTD-2F01-3200-HP240	30573068
23,00	23	QTD-2F01-2300-HP240	30573037	33,00	33	QTD-2F01-3300-HP240	30649656
23,25	23	QTD-2F01-2325-HP240	30573038	34,00	34	QTD-2F01-3400-HP240	30649657
23,50	23	QTD-2F01-2350-HP240	30573039	35,00	35	QTD-2F01-3500-HP240	30649658
23,75	23	QTD-2F01-2375-HP240	30573042	36,00	36	QTD-2F01-3600-HP240	30649659
24,00	24	QTD-2F01-2400-HP240	30573043	37,00	37	QTD-2F01-3700-HP240	30649660
24,30	24	QTD-2F01-2430-HP240	30646105	38,00	37	QTD-2F01-3800-HP240	30649661
24,50	24	QTD-2F01-2450-HP240	30573044	40,00	39	QTD-2F01-4000-HP240	30657233
24,70	24	QTD-2F01-2470-HP240	30573045	42,00	41	QTD-2F01-4200-HP240	30657235

Características configurables



Diámetro:
Diámetro seleccionable libremente en incrementos de 0,01 mm



Especificación
QTD-2F01-[diámetro]-HP240

Dimensiones de la serie configurable

d ₁ mín.	d ₁ máx.
9,00	50,00

Ejemplo:
QTD-2F01-0901-HP240

Diámetro de la herramienta d₁ = 9,01 mm

Medidas en mm.

Para la recomendación de valores de corte, véase al final del capítulo.
Ejecuciones especiales y otros recubrimientos a petición.

Placas de corte QTD

De metal duro, suministro de refrigerante interior
Tipo 05 – Steel-Pyramid

Ejecución:

Diámetro de broca:	14,00 - 32,00 mm
Tolerancia del agujero:	≥ IT 10
Material de corte:	HP605
Número de insertos:	2
Número de bisel guía:	2
Ángulo de la punta:	165°

Aplicación:

Para mecanizados con exigencias especiales de centrado de la herramienta. (Por ejemplo, componentes de paredes finas, condiciones de mecanizado inestables).

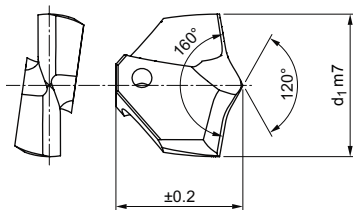

Serie preferente disponible en stock

Dimensiones		Especificación	Referencia
d ₁ m7	Tamaño del soporte D		
14,00	14	QTD-2F05-1400-HP605	31126352
15,00	15	QTD-2F05-1500-HP605	31126356
16,00	16	QTD-2F05-1600-HP605	31126361
16,50	16	QTD-2F05-1650-HP605	31126364
17,50	17	QTD-2F05-1750-HP605	31126366
18,00	18	QTD-2F05-1800-HP605	31126368
18,50	18	QTD-2F05-1850-HP605	31126369
19,27	19	QTD-2F05-1927-HP605	31208007
19,80	19	QTD-2F05-1980-HP605	31126372
20,00	20	QTD-2F05-2000-HP605	31126373
20,50	20	QTD-2F05-2050-HP605	31126374
21,00	21	QTD-2F05-2100-HP605	31126375
21,50	21	QTD-2F05-2150-HP605	31126376
22,00	22	QTD-2F05-2200-HP605	31126377
23,00	23	QTD-2F05-2300-HP605	31126379
24,00	24	QTD-2F05-2400-HP605	31126380
25,00	25	QTD-2F05-2500-HP605	31126382
26,00	26	QTD-2F05-2600-HP605	31126384
26,50	26	QTD-2F05-2650-HP605	31126385
27,00	27	QTD-2F05-2700-HP605	31126386
28,00	28	QTD-2F05-2800-HP605	31126387
29,00	29	QTD-2F05-2900-HP605	31126388
30,00	30	QTD-2F05-3000-HP605	31126389
32,00	32	QTD-2F05-3200-HP605	31126391

Características configurables



Diámetro:
Diámetro seleccionable libremente en incrementos de 0,01 mm



Especificación

QTD-2F01-[diámetro]-HP240

Dimensiones de la serie configurable

d ₁ mín.	d ₁ máx.
14,00	32,00

Ejemplo:

QTD-2F01-1401-HP240

Diámetro de la herramienta d₁ = 14,01 mm

Medidas en mm.

Para la recomendación de valores de corte, véase al final del capítulo.
Ejecuciones especiales y otros recubrimientos a petición.

Ensayo práctico

Mecanizado de chapa, intercambiadores de calor/chapas de caldera, vigas de acero (T, U, ...).

Especialmente para el mecanizado con exigencias especiales de centrado de la herramienta, así como para componentes de paredes finas y condiciones de mecanizado inestables.



Datos de mecanizado

Herramienta:	∅ 18 mm 5xD
Adaptador:	Portaherramientas de sujeción lateral
Refrigeración:	Refrigeración interna MMS
IB [mm]:	90
vc [m/min]:	63
n [min ⁻¹]:	1,115
f [mm]:	0,3
vf [mm/min]:	334

Número de agujeros

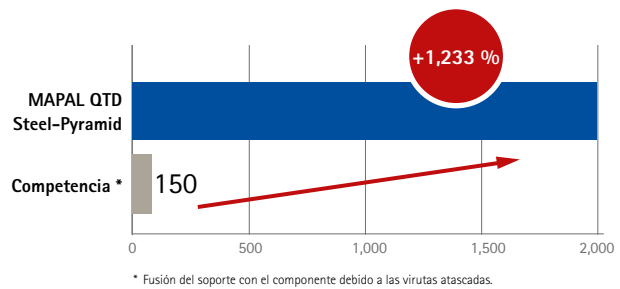

Placas de corte QTD

Completo en metal duro,
Tipo 10 – Uni, forma EK

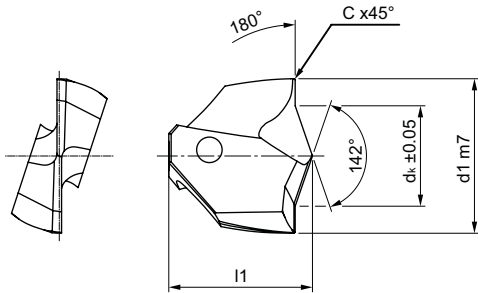

Ejecución:

Diámetro de broca:	10,00 - 33,00 mm
Tolerancia del agujero:	≥ IT 10
Material de corte:	HP240
Número de insertos:	2
Número de bisel guía:	2
Ángulo de la punta:	142°
Particularidades:	Forma EK Inserto de 180°, bisel protector 0,5 mm

Aplicación:

Para agujeros pasantes de tornillos según DIN-ISO 273 y avellanados según DIN 74, hoja 2 forma H, J y K, ejecución media.
Para tornillos según DIN 912, 6912 y 7984, ISO 1207 (DIN 84).



Serie preferente disponible en stock

Dimensiones			Para tornillos DIN de culata	Adecuado para Ø Agujero pasante	Especificación	Referencia
d ₁ m7	d _k ±0,05	Tamaño del soporte D				
10,00	6,50	10	M5	5,5	QTD-2F10-1000-HP240	30868435
11,00	7,60	11	M6	6,6	QTD-2F10-1100-HP240	30868436
15,00	10,00	15	M8	9	QTD-2F10-1500-HP240	30868437
18,00	11,00	18	M10	11	QTD-2F10-1800-HP240	30868438
20,00	14,50	20	M12	13,5	QTD-2F10-2000-HP240	30868439
24,00	16,50	24	M14	15	QTD-2F10-2400-HP240	30868440
26,00	18,50	26	M16	17	QTD-2F10-2600-HP240	30868441
30,00	20,50	30	M18	19	QTD-2F10-3000-HP240	30868442
33,00	23,00	33	M20	21	QTD-2F10-3300-HP240	30868443

Información de aplicación

Creación de un agujero pasante de tornillo con avellanado para tornillos de culata según DIN (ejemplo M12)

1. Paso

Avellanado con QTD tipo 10, forma EK (ejemplo diámetro 20 mm)

2. Paso

Agujero con taladro completo (ejemplo diámetro 13,5 mm)

Resultado:

Agujero pasante de tornillo con avellanado y bisel para tornillo de culata M12

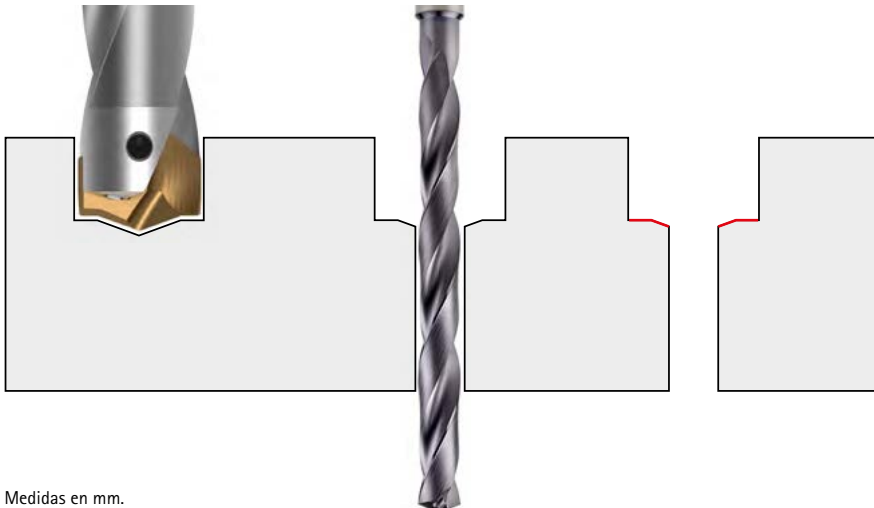

Medidas en mm.

Para la recomendación de valores de corte, véase al final del capítulo.
Ejecuciones especiales y otros recubrimientos a petición.

Placas de corte QTD

De metal duro, suministro de refrigerante interior
Tipo 02 – Inox

Ejecución:

Diámetro de broca:	9,00 - 50,00 mm
Tolerancia del agujero:	≥ IT 10
Material de corte:	HP600
Número de insertos:	2
Número de bisel guía:	2
Ángulo de la punta:	135°

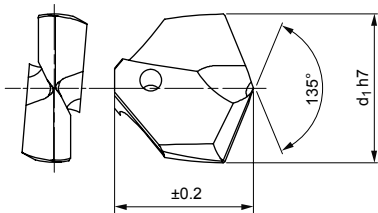

Serie preferente disponible en stock

d ₁ de 10,00 a 16,70			
d ₁ h7	Tamaño del soporte D	Especificación	Referencia
10,00	10	QTD-2F02-1000-HP600	30615624
10,50	10,5	QTD-2F02-1050-HP600	30615625
11,00	11	QTD-2F02-1100-HP600	30615627
12,00	12	QTD-2F02-1200-HP600	30615630
12,50	12,5	QTD-2F02-1250-HP600	30615631
13,00	13	QTD-2F02-1300-HP600	30573070
13,50	13,5	QTD-2F02-1350-HP600	30573072
14,00	14	QTD-2F02-1400-HP600	30573074
14,10	14	QTD-2F02-1410-HP600	30646120
14,20	14	QTD-2F02-1420-HP600	30630410
14,30	14	QTD-2F02-1430-HP600	30646122
14,40	14	QTD-2F02-1440-HP600	30646123
14,50	14,5	QTD-2F02-1450-HP600	30573075
14,60	14,5	QTD-2F02-1460-HP600	30646124
14,70	14,5	QTD-2F02-1470-HP600	30573076
14,75	14,5	QTD-2F02-1475-HP600	30573077
14,80	14,5	QTD-2F02-1480-HP600	30646125
15,00	15	QTD-2F02-1500-HP600	30573078
15,20	15	QTD-2F02-1520-HP600	30646128
15,25	15	QTD-2F02-1525-HP600	30573079
15,40	15	QTD-2F02-1540-HP600	30646130
15,50	15	QTD-2F02-1550-HP600	30573080
15,60	15	QTD-2F02-1560-HP600	30646131
15,70	15	QTD-2F02-1570-HP600	30573081
15,80	15	QTD-2F02-1580-HP600	30646132
16,00	16	QTD-2F02-1600-HP600	30573083
16,10	16	QTD-2F02-1610-HP600	30573086
16,20	16	QTD-2F02-1620-HP600	30646134
16,30	16	QTD-2F02-1630-HP600	30646135
16,40	16	QTD-2F02-1640-HP600	30646136
16,50	16	QTD-2F02-1650-HP600	30573088
16,60	16	QTD-2F02-1660-HP600	30646137
16,70	16	QTD-2F02-1670-HP600	30573089

d ₁ de 16,75 a 23,75			
d ₁ h7	Tamaño del soporte D	Especificación	Referencia
16,75	16	QTD-2F02-1675-HP600	30573090
16,80	16	QTD-2F02-1680-HP600	30646138
16,90	16	QTD-2F02-1690-HP600	30646139
17,00	17	QTD-2F02-1700-HP600	30573091
17,30	17	QTD-2F02-1730-HP600	30646142
17,40	17	QTD-2F02-1740-HP600	30646143
17,50	17	QTD-2F02-1750-HP600	30573092
17,70	17	QTD-2F02-1770-HP600	30573093
17,90	17	QTD-2F02-1790-HP600	30646146
18,00	18	QTD-2F02-1800-HP600	30573094
18,50	18	QTD-2F02-1850-HP600	30573096
18,60	18	QTD-2F02-1860-HP600	30646151
18,70	18	QTD-2F02-1870-HP600	30573097
19,00	19	QTD-2F02-1900-HP600	30573098
19,40	19	QTD-2F02-1940-HP600	30573101
19,50	19	QTD-2F02-1950-HP600	30573102
19,60	19	QTD-2F02-1960-HP600	30646157
19,70	19	QTD-2F02-1970-HP600	30573103
19,75	19	QTD-2F02-1975-HP600	30573104
19,80	19	QTD-2F02-1980-HP600	30646158
19,90	19	QTD-2F02-1990-HP600	30646159
20,00	20	QTD-2F02-2000-HP600	30573105
20,40	20	QTD-2F02-2040-HP600	30573106
20,50	20	QTD-2F02-2050-HP600	30573107
21,00	21	QTD-2F02-2100-HP600	30573110
21,50	21	QTD-2F02-2150-HP600	30573111
21,70	21	QTD-2F02-2170-HP600	30573112
22,00	22	QTD-2F02-2200-HP600	30573113
22,25	22	QTD-2F02-2225-HP600	30573114
22,70	22	QTD-2F02-2270-HP600	30573117
23,00	23	QTD-2F02-2300-HP600	30573119
23,50	23	QTD-2F02-2350-HP600	30573121
23,75	23	QTD-2F02-2375-HP600	30573124

Continúa en la página siguiente.

Placas de corte QTD de metal duro, suministro de refrigerante interior – Tipo O2

d ₁ de 24,00 a 27,00				d ₁ de 27,50 a 40,00			
d ₁ h7	Tamaño del soporte D	Especificación	Referencia	d ₁ h7	Tamaño del soporte D	Especificación	Referencia
24,00	24	QTD-2F02-2400-HP600	30573125	27,50	27	QTD-2F02-2750-HP600	30573136
24,40	24	QTD-2F02-2440-HP600	30665151	28,00	28	QTD-2F02-2800-HP600	30573138
24,50	24	QTD-2F02-2450-HP600	30573126	29,00	29	QTD-2F02-2900-HP600	30573141
24,70	24	QTD-2F02-2470-HP600	30573127	29,50	29	QTD-2F02-2950-HP600	30573142
24,75	24	QTD-2F02-2475-HP600	30573128	30,00	30	QTD-2F02-3000-HP600	30573143
25,00	25	QTD-2F02-2500-HP600	30573129	30,75	30	QTD-2F02-3075-HP600	30573146
25,50	25	QTD-2F02-2550-HP600	30573131	33,00	33	QTD-2F02-3300-HP600	30649662
25,70	25	QTD-2F02-2570-HP600	30573132	36,00	36	QTD-2F02-3600-HP600	30649665
26,00	26	QTD-2F02-2600-HP600	30573133	37,00	37	QTD-2F02-3700-HP600	30649666
26,50	26	QTD-2F02-2650-HP600	30573134	40,00	39	QTD-2F02-4000-HP600	30657246
27,00	27	QTD-2F02-2700-HP600	30573135				

Características configurables



Diámetro:
Diámetro seleccionable libremente en incrementos de 0,01 mm



Especificación
QTD-2F02-[diámetro]-HP600

Dimensiones de la serie configurable

d ₁ mín.	d ₁ máx.
9,00	50,00

Ejemplo:

QTD-2F02-1401-HP600

Diámetro de la herramienta d₁ = 14,01 mm

Placas de corte QTD

De metal duro, suministro de refrigerante interior
Tipo 04 – Iron

Ejecución:

Diámetro de broca:	9,00 - 50,00 mm
Tolerancia del agujero:	≥ IT 10
Material de corte:	HP240
Número de insertos:	2
Número de biseles guía:	2
Ángulo de la punta:	135°

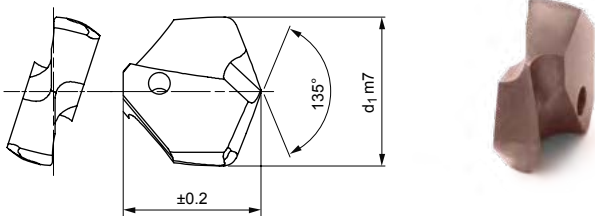

Serie preferente disponible en stock

d ₁ de 12,00 a 23,00			
d ₁ m7	Tamaño del soporte D	Especificación	Referencia
12,00	12	QTD-2F04-1200-HP240	30615805
14,00	14	QTD-2F04-1400-HP240	30612900
14,50	14,5	QTD-2F04-1450-HP240	30612901
17,00	17	QTD-2F04-1700-HP240	30612915
17,50	17	QTD-2F04-1750-HP240	30612916
18,00	18	QTD-2F04-1800-HP240	30612918
19,00	19	QTD-2F04-1900-HP240	30612922
19,10	19	QTD-2F04-1910-HP240	30646366
19,50	19	QTD-2F04-1950-HP240	30612926
20,50	20	QTD-2F04-2050-HP240	30612931
21,00	21	QTD-2F04-2100-HP240	30612934
21,50	21	QTD-2F04-2150-HP240	30612935
22,00	22	QTD-2F04-2200-HP240	30612937
23,00	23	QTD-2F04-2300-HP240	30612943

d ₁ de 23,50 a 33,00			
d ₁ m7	Tamaño del soporte D	Especificación	Referencia
23,50	23	QTD-2F04-2350-HP240	30612945
24,00	24	QTD-2F04-2400-HP240	30612949
24,50	24	QTD-2F04-2450-HP240	30612950
25,00	25	QTD-2F04-2500-HP240	30612953
25,70	25	QTD-2F04-2570-HP240	30612956
26,00	26	QTD-2F04-2600-HP240	30612957
26,50	26	QTD-2F04-2650-HP240	30612958
28,00	28	QTD-2F04-2800-HP240	30612962
28,50	28	QTD-2F04-2850-HP240	30612964
29,00	29	QTD-2F04-2900-HP240	30612965
29,50	29	QTD-2F04-2950-HP240	30612966
30,00	30	QTD-2F04-3000-HP240	30612967
31,00	31	QTD-2F04-3100-HP240	30612971
33,00	33	QTD-2F04-3300-HP240	30649674

Características configurables



Diámetro:
Diámetro seleccionable libremente en incrementos de 0,01 mm

Especificación
QTD-2F02-[diámetro]-HP600

Dimensiones de la serie configurable

d ₁ min.	d ₁ máx.
9,00	50,00

Ejemplo:

QTD-2F02-1401-HP600

Diámetro de la herramienta d₁ = 14,01 mm

Medidas en mm.

Para la recomendación de valores de corte, véase al final del capítulo.
Ejecuciones especiales y otros recubrimientos a petición.

Placas de corte QTD

De metal duro, suministro de refrigerante interior
Tipo 03 – Alu

Ejecución:

Diámetro de broca:	9,00 - 50,00 mm
Tolerancia del agujero:	≥ IT 10
Material de corte:	HU310
Número de insertos:	2
Número de biseles guía:	2
Ángulo de la punta:	135°

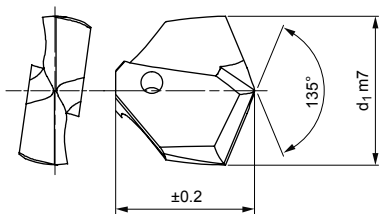

Serie preferente disponible en stock

d ₁ de 13,00 a 20,50			
d ₁ m7	Tamaño del soporte D	Especificación	Referencia
13,00	13	QTD-2F03-1300-HU310	30612819
13,50	13,5	QTD-2F03-1350-HU310	30612820
14,00	14	QTD-2F03-1400-HU310	30612822
14,50	14,5	QTD-2F03-1450-HU310	30612823
15,00	15	QTD-2F03-1500-HU310	30612826
15,50	15	QTD-2F03-1550-HU310	30612828
16,00	16	QTD-2F03-1600-HU310	30612830
17,00	17	QTD-2F03-1700-HU310	30612837
17,50	17	QTD-2F03-1750-HU310	30612838
18,25	18	QTD-2F03-1825-HU310	30612841
18,50	18	QTD-2F03-1850-HU310	30612842
19,00	19	QTD-2F03-1900-HU310	30612844
20,00	20	QTD-2F03-2000-HU310	30612851
20,50	20	QTD-2F03-2050-HU310	30612853

d ₁ de 21,00 a 36,00			
d ₁ m7	Tamaño del soporte D	Especificación	Referencia
21,00	21	QTD-2F03-2100-HU310	30612856
22,00	22	QTD-2F03-2200-HU310	30612859
22,50	22	QTD-2F03-2250-HU310	30612862
23,00	23	QTD-2F03-2300-HU310	30612865
23,50	23	QTD-2F03-2350-HU310	30612867
24,00	24	QTD-2F03-2400-HU310	30612871
24,50	24	QTD-2F03-2450-HU310	30612872
25,00	25	QTD-2F03-2500-HU310	30612875
26,00	26	QTD-2F03-2600-HU310	30612879
27,00	27	QTD-2F03-2700-HU310	30612881
29,50	29	QTD-2F03-2950-HU310	30612888
30,00	30	QTD-2F03-3000-HU310	30612889
34,00	34	QTD-2F03-3400-HU310	30649669
36,00	36	QTD-2F03-3600-HU310	30649671

Características configurables



Diámetro:
Diámetro seleccionable libremente en incrementos de 0,01 mm

Especificación
QTD-2F03-[diámetro]-HU310

Dimensiones de la serie configurable

d ₁ mín.	d ₁ máx.
9,00	50,00

Ejemplo:

QTD-2F02-1401-HU310

Diámetro de la herramienta d₁ = 14,01 mm

Medidas en mm.

Para la recomendación de valores de corte, véase al final del capítulo.
Ejecuciones especiales y otros recubrimientos a petición.

Soportes para placas de corte QTS

Con amarre prismático para placas de corte QTD
QTS100S, con suministro de refrigerante interior

Ejecución:

Para diámetros:

9,00 - 50,99 mm

Forma del mango:

según ISO 9766

Sistema de cambio:

Amarre prismático,
posibilidad de cam-
bio de insertos en la
máquina

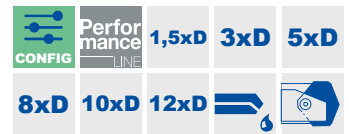
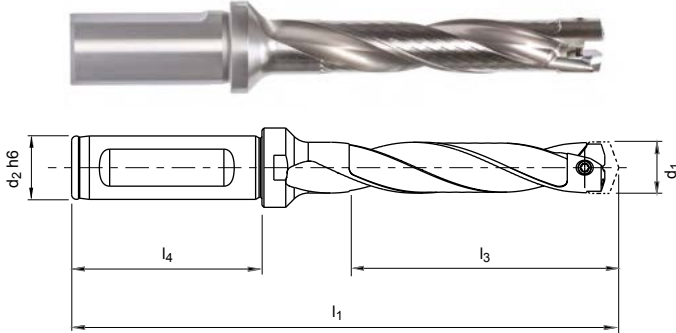

Serie preferente disponible en stock

Tamaño del soporte D	Dimensiones					Especificación	Referencia
	Rango de diámetros Placa de corte d ₁	d ₂ h6	l ₁	l ₃	l ₄		
9,00	9,00 - 9,49	12	110	48	45	QTS100S-0900-DR05-ZYL12-MN	30605484
9,50	9,50 - 9,99	12	113	50	45	QTS100S-0950-DR05-ZYL12-MN	30605485
10,00	10,00 - 10,49	16	99	32	48	QTS100S-1000-DR03-ZYL16-MN	30605476
10,00	10,00 - 10,49	16	120	53	48	QTS100S-1000-DR05-ZYL16-MN	30605486
10,50	10,50 - 10,99	16	122	55	48	QTS100S-1050-DR05-ZYL16-MN	30605487
11,00	11,00 - 11,49	16	126	58	48	QTS100S-1100-DR05-ZYL16-MN	30605488
11,00	11,00 - 11,49	16	160	92	48	QTS100S-1100-DR08-ZYL16-MN	30605498
11,50	11,50 - 11,99	16	105	36	48	QTS100S-1150-DR03-ZYL16-MN	30605479
12,00	12,00 - 12,49	16	107	38	48	QTS100S-1200-DR03-ZYL16-MN	30605480
12,00	12,00 - 12,49	16	132	63	48	QTS100S-1200-DR05-ZYL16-MN	30605490
12,00	12,00 - 12,49	16	169	100	48	QTS100S-1200-DR08-ZYL16-MN	30605500
12,50	12,50 - 12,99	16	109	39	48	QTS100S-1250-DR03-ZYL16-MN	30605481
12,50	12,50 - 12,99	16	135	65	48	QTS100S-1250-DR05-ZYL16-MN	30605491
12,50	12,50 - 12,99	16	174	104	48	QTS100S-1250-DR08-ZYL16-MN	30605501
13,00	13,00 - 13,49	16	112	41	48	QTS100S-1300-DR03-ZYL16-MN	30572922
13,00	13,00 - 13,49	16	138	68	48	QTS100S-1300-DR05-ZYL16-MN	30572945
13,00	13,00 - 13,49	16	178	108	48	QTS100S-1300-DR08-ZYL16-MN	30572967
13,00	13,00 - 13,49	16	232	162	48	QTS100S-1300-DR12-ZYL16-MN	30598728
13,50	13,50 - 13,99	16	211	140	48	QTS100S-1350-DR10-ZYL16-MN	30826051
13,50	13,50 - 13,99	16	239	168	48	QTS100S-1350-DR12-ZYL16-MN	30598729
14,00	14,00 - 14,49	16	116	44	48	QTS100S-1400-DR03-ZYL16-MN	30572924
14,00	14,00 - 14,49	16	144	73	48	QTS100S-1400-DR05-ZYL16-MN	30572947
14,00	14,00 - 14,49	16	187	116	48	QTS100S-1400-DR08-ZYL16-MN	30572970
14,00	14,00 - 14,49	16	245	174	48	QTS100S-1400-DR12-ZYL16-MN	30598730
14,50	14,50 - 14,99	16	95	23	48	QTS100S-1450-DR01-ZYL16-MN	30572903
14,50	14,50 - 14,99	16	147	75	48	QTS100S-1450-DR05-ZYL16-MN	30572948
15,00	15,00 - 15,99	20	124	48	50	QTS100S-1500-DR03-ZYL20-MN	30572926
15,00	15,00 - 15,99	20	155	80	50	QTS100S-1500-DR05-ZYL20-MN	30572949
15,00	15,00 - 15,99	20	203	128	50	QTS100S-1500-DR08-ZYL20-MN	30572972
15,00	15,00 - 15,99	20	237	162	50	QTS100S-1500-DR10-ZYL20-MN	30826054
15,00	15,00 - 15,99	20	267	192	50	QTS100S-1500-DR12-ZYL20-MN	30598732
16,00	16,00 - 16,99	20	102	26	50	QTS100S-1600-DR01-ZYL20-MN	30572905
16,00	16,00 - 16,99	20	128	51	50	QTS100S-1600-DR03-ZYL20-MN	30572927
16,00	16,00 - 16,99	20	161	85	50	QTS100S-1600-DR05-ZYL20-MN	30572950

Soportes para placas de corte QTS100, con suministro de refrigerante interior

Tamaño del soporte D	Dimensiones					Especificación	Referencia
	Rango de diámetros Placa de corte d ₁	d ₂ h ₆	l ₁	l ₃	l ₄		
16,00	16,00 - 16,99	20	212	136	50	QTS100S-1600-DR08-ZYL20-MN	30572973
16,00	16,00 - 16,99	20	246	170	50	QTS100S-1600-DR10-ZYL20-MN	30826055
17,00	17,00 - 17,99	20	105	27	50	QTS100S-1700-DR01-ZYL20-MN	30572906
17,00	17,00 - 17,99	20	132	54	50	QTS100S-1700-DR03-ZYL20-MN	30572928
17,00	17,00 - 17,99	20	168	90	50	QTS100S-1700-DR05-ZYL20-MN	30572951
17,00	17,00 - 17,99	20	222	144	50	QTS100S-1700-DR08-ZYL20-MN	30572974
17,00	17,00 - 17,99	20	258	180	50	QTS100S-1700-DR10-ZYL20-MN	30826056
17,00	17,00 - 17,99	20	294	216	50	QTS100S-1700-DR12-ZYL20-MN	30598734
18,00	18,00 - 18,99	25	142	57	56	QTS100S-1800-DR03-ZYL25-MN	30572929
18,00	18,00 - 18,99	25	180	95	56	QTS100S-1800-DR05-ZYL25-MN	30572952
18,00	18,00 - 18,99	25	237	152	56	QTS100S-1800-DR08-ZYL25-MN	30572975
18,00	18,00 - 18,99	25	313	228	56	QTS100S-1800-DR12-ZYL25-MN	30598735
19,00	19,00 - 19,99	25	116	30	56	QTS100S-1900-DR01-ZYL25-MN	30572908
19,00	19,00 - 19,99	25	146	60	56	QTS100S-1900-DR03-ZYL25-MN	30572930
19,00	19,00 - 19,99	25	186	100	56	QTS100S-1900-DR05-ZYL25-MN	30572953
19,00	19,00 - 19,99	25	246	160	56	QTS100S-1900-DR08-ZYL25-MN	30572976
20,00	20,00 - 20,99	25	151	63	56	QTS100S-2000-DR03-ZYL25-MN	30572931
20,00	20,00 - 20,99	25	192	105	56	QTS100S-2000-DR05-ZYL25-MN	30572954
20,00	20,00 - 20,99	25	255	168	56	QTS100S-2000-DR08-ZYL25-MN	30572977
20,00	20,00 - 20,99	25	297	210	56	QTS100S-2000-DR10-ZYL25-MN	30826059
20,00	20,00 - 20,99	25	339	252	56	QTS100S-2000-DR12-ZYL25-MN	30598737
21,00	21,00 - 21,99	25	121	33	56	QTS100S-2100-DR01-ZYL25-MN	30572910
21,00	21,00 - 21,99	25	155	66	56	QTS100S-2100-DR03-ZYL25-MN	30572932
21,00	21,00 - 21,99	25	198	110	56	QTS100S-2100-DR05-ZYL25-MN	30572955
21,00	21,00 - 21,99	25	264	176	56	QTS100S-2100-DR08-ZYL25-MN	30572978
21,00	21,00 - 21,99	25	308	220	56	QTS100S-2100-DR10-ZYL25-MN	30826060
22,00	22,00 - 22,99	25	125	35	56	QTS100S-2200-DR01-ZYL25-MN	30572911
22,00	22,00 - 22,99	25	159	69	56	QTS100S-2200-DR03-ZYL25-MN	30572933
22,00	22,00 - 22,99	25	205	115	56	QTS100S-2200-DR05-ZYL25-MN	30572956
22,00	22,00 - 22,99	25	274	184	56	QTS100S-2200-DR08-ZYL25-MN	30572979
23,00	23,00 - 23,99	25	127	36	56	QTS100S-2300-DR01-ZYL25-MN	30572912
23,00	23,00 - 23,99	25	211	120	56	QTS100S-2300-DR05-ZYL25-MN	30572957
23,00	23,00 - 23,99	25	379	288	56	QTS100S-2300-DR12-ZYL25-MN	30598740
24,00	24,00 - 24,99	32	171	75	60	QTS100S-2400-DR03-ZYL32-MN	30572935
24,00	24,00 - 24,99	32	221	125	60	QTS100S-2400-DR05-ZYL32-MN	30572958
24,00	24,00 - 24,99	32	296	200	60	QTS100S-2400-DR08-ZYL32-MN	30572981
24,00	24,00 - 24,99	32	396	300	60	QTS100S-2400-DR12-ZYL32-MN	30598741
25,00	25,00 - 25,99	32	136	39	60	QTS100S-2500-DR01-ZYL32-MN	30572914
25,00	25,00 - 25,99	32	176	78	60	QTS100S-2500-DR03-ZYL32-MN	30572937
25,00	25,00 - 25,99	32	227	130	60	QTS100S-2500-DR05-ZYL32-MN	30572959
25,00	25,00 - 25,99	32	305	208	60	QTS100S-2500-DR08-ZYL32-MN	30572982
25,00	25,00 - 25,99	32	409	312	60	QTS100S-2500-DR12-ZYL32-MN	30598742
26,00	26,00 - 26,99	32	139	41	60	QTS100S-2600-DR01-ZYL32-MN	30572915
26,00	26,00 - 26,99	32	180	81	60	QTS100S-2600-DR03-ZYL32-MN	30572938
26,00	26,00 - 26,99	32	233	135	60	QTS100S-2600-DR05-ZYL32-MN	30572960
26,00	26,00 - 26,99	32	314	216	60	QTS100S-2600-DR08-ZYL32-MN	30572983
26,00	26,00 - 26,99	32	368	270	60	QTS100S-2600-DR10-ZYL32-MN	30826065
27,00	27,00 - 27,99	32	184	84	60	QTS100S-2700-DR03-ZYL32-MN	30572939
27,00	27,00 - 27,99	32	324	224	60	QTS100S-2700-DR08-ZYL32-MN	30572984
28,00	28,00 - 28,99	32	188	87	60	QTS100S-2800-DR03-ZYL32-MN	30572940
28,00	28,00 - 28,99	32	246	145	60	QTS100S-2800-DR05-ZYL32-MN	30572962
28,00	28,00 - 28,99	32	449	348	60	QTS100S-2800-DR12-ZYL32-MN	30598745
29,00	29,00 - 29,99	32	402	300	60	QTS100S-2900-DR10-ZYL32-MN	30826068
30,00	30,00 - 30,99	32	197	93	60	QTS100S-3000-DR03-ZYL32-MN	30572942
30,00	30,00 - 30,99	32	351	248	60	QTS100S-3000-DR08-ZYL32-MN	30572987
30,00	30,00 - 30,99	32	413	310	60	QTS100S-3000-DR10-ZYL32-MN	30826069

Soportes para placas de corte QTS100, con suministro de refrigerante interior

Tamaño del soporte D	Dimensiones					Especificación	Referencia
	Rango de diámetros Placa de corte d ₁	d ₂ h ₆	l ₁	l ₃	l ₄		
30,00	30,00 - 30,99	32	475	372	60	QTS100S-3000-DR12-ZYL32-MN	30598747
31,00	31,00 - 31,99	32	264	160	60	QTS100S-3100-DR05-ZYL32-MN	30572965
32,00	32,00 - 32,99	32	271	165	60	QTS100S-3200-DR05-ZYL32-MN	30572966
32,00	32,00 - 32,99	32	436	330	60	QTS100S-3200-DR10-ZYL32-MN	30826071
32,00	32,00 - 32,99	32	502	396	60	QTS100S-3200-DR12-ZYL32-MN	30598749
33,00	33,00 - 33,99	32	209	102	60	QTS100S-3300-DR03-ZYL32-MN	30639167
34,00	34,00 - 34,99	32	283	175	60	QTS100S-3400-DR05-ZYL32-MN	30639172
35,00	35,00 - 35,99	32	218	108	60	QTS100S-3500-DR03-ZYL32-MN	30639169
36,00	36,00 - 36,99	32	222	111	60	QTS100S-3600-DR03-ZYL32-MN	30639170
37,00	37,00 - 38,99	40	318	195	70	QTS100S-3700-DR05-ZYL40-MN	30650288
39,00	39,00 - 40,99	40	249	123	70	QTS100S-3900-DR03-ZYL40-MN	30650284
41,00	41,00 - 42,99	40	257	129	70	QTS100S-4100-DR03-ZYL40-MN	30650285

Características configurables



Ejecución de longitud:
DR01 | DR03 | DR05 | DR08 | DR10 | DR12



Especificación
QTS100S-3500-[ejecución de longitud]-ZYL32-MN

Ejemplo:
QTS100S-3500-DR10-ZYL32-MN

Ejecución de longitud 10xD

Dimensiones de la serie configurable

Tamaño del soporte D	Rango de diámetros de la placa de corte d ₁	d ₂ h ₆	l ₄	DR01		DR03		DR05		DR08		DR10		DR12		Especificación
				l ₁	l ₃	l ₁	l ₃	l ₁	l ₃	l ₁	l ₃	l ₁	l ₃	l ₁	l ₃	
9	9,00 - 9,49	12	45	77	15	92	29	110	48	138	76	-	-	-	-	QTS100S-0900-[ejecución de longitud]-ZYL12-MN
9,5	9,50 - 9,99	12	45	78	15	93	30	113	50	143	80	-	-	-	-	QTS100S-0950-[ejecución de longitud]-ZYL12-MN
10	10,00 - 10,49	16	48	83	16	99	32	120	53	151	84	-	-	-	-	QTS100S-1000-[ejecución de longitud]-ZYL16-MN
10,5	10,50 - 10,99	16	48	84	17	101	33	122	55	155	88	-	-	-	-	QTS100S-1050-[ejecución de longitud]-ZYL16-MN
11	11,00 - 11,49	16	48	86	18	103	35	126	58	160	92	-	-	-	-	QTS100S-1100-[ejecución de longitud]-ZYL16-MN
11,5	11,50 - 11,99	16	48	86	18	105	36	128	60	164	96	-	-	-	-	QTS100S-1150-[ejecución de longitud]-ZYL16-MN
12	12,00 - 12,49	16	48	88	19	107	38	132	63	169	100	-	-	-	-	QTS100S-1200-[ejecución de longitud]-ZYL16-MN
12,5	12,50 - 12,99	16	48	90	20	109	39	135	65	174	104	-	-	-	-	QTS100S-1250-[ejecución de longitud]-ZYL16-MN
13	13,00 - 13,49	16	48	91	21	112	41	138	68	178	108	205	135	232	162	QTS100S-1300-[ejecución de longitud]-ZYL16-MN
13,5	13,50 - 13,99	16	48	92	21	113	42	141	70	183	112	211	140	239	168	QTS100S-1350-[ejecución de longitud]-ZYL16-MN
14	14,00 - 14,49	16	48	93	22	116	44	144	73	187	116	216	145	245	174	QTS100S-1400-[ejecución de longitud]-ZYL16-MN
14,5	14,50 - 14,99	16	48	95	23	117	45	147	75	192	120	222	150	252	180	QTS100S-1450-[ejecución de longitud]-ZYL16-MN
15	15,00 - 15,99	20	50	99	24	124	48	155	80	203	128	237	162	267	192	QTS100S-1500-[ejecución de longitud]-ZYL20-MN
16	16,00 - 16,99	20	50	102	26	128	51	161	85	212	136	246	170	280	204	QTS100S-1600-[ejecución de longitud]-ZYL20-MN
17	17,00 - 17,99	20	50	105	27	132	54	168	90	222	144	258	180	294	216	QTS100S-1700-[ejecución de longitud]-ZYL20-MN
18	18,00 - 18,99	25	56	114	29	142	57	180	95	237	152	275	190	313	228	QTS100S-1800-[ejecución de longitud]-ZYL25-MN
19	19,00 - 19,99	25	56	116	30	146	60	186	100	246	160	286	200	326	240	QTS100S-1900-[ejecución de longitud]-ZYL25-MN
20	20,00 - 20,99	25	56	119	32	151	63	192	105	255	168	297	210	339	252	QTS100S-2000-[ejecución de longitud]-ZYL25-MN
21	21,00 - 21,99	25	56	121	33	155	66	198	110	264	176	308	220	352	264	QTS100S-2100-[ejecución de longitud]-ZYL25-MN
22	22,00 - 22,99	25	56	125	35	159	69	205	115	274	184	320	230	366	276	QTS100S-2200-[ejecución de longitud]-ZYL25-MN
23	23,00 - 23,99	25	56	127	36	163	72	211	120	283	192	331	240	379	288	QTS100S-2300-[ejecución de longitud]-ZYL25-MN
24	24,00 - 24,99	32	60	134	38	171	75	221	125	296	200	346	250	396	300	QTS100S-2400-[ejecución de longitud]-ZYL32-MN
25	25,00 - 25,99	32	60	136	39	176	78	227	130	305	208	357	260	409	312	QTS100S-2500-[ejecución de longitud]-ZYL32-MN
26	26,00 - 26,99	32	60	139	41	180	81	233	135	314	216	368	270	422	324	QTS100S-2600-[ejecución de longitud]-ZYL32-MN
27	27,00 - 27,99	32	60	142	42	184	84	240	140	324	224	380	280	436	336	QTS100S-2700-[ejecución de longitud]-ZYL32-MN

Continúa en la página siguiente.

Dimensiones de la serie configurable

Tamaño del soporte D	Rango de diámetros de la placa de corte d ₁	d ₂ h ₆	l ₄	DR01		DR03		DR05		DR08		DR10		DR12		Especificación
				l ₁	l ₃	l ₁	l ₃	l ₁	l ₃	l ₁	l ₃	l ₁	l ₃	l ₁	l ₃	
28	28,00 - 28,99	32	60	145	44	188	87	246	145	333	232	391	290	449	348	QTS100S-2800-[ejecución de longitud]-ZYL32-MN
29	29,00 - 29,99	32	60	147	45	192	90	252	150	342	240	402	300	462	360	QTS100S-2900-[ejecución de longitud]-ZYL32-MN
30	30,00 - 30,99	32	60	150	47	197	93	258	155	351	248	413	310	475	372	QTS100S-3000-[ejecución de longitud]-ZYL32-MN
31	31,00 - 31,99	32	60	152	48	201	96	264	160	360	256	424	320	488	384	QTS100S-3100-[ejecución de longitud]-ZYL32-MN
32	32,00 - 32,99	32	60	156	50	205	99	271	165	370	264	436	330	502	396	QTS100S-3200-[ejecución de longitud]-ZYL32-MN
33	33,00 - 33,99	32	60	158	51	209	102	277	170	379	272	447	340	515	408	QTS100S-3300-[ejecución de longitud]-ZYL32-MN
34	34,00 - 34,99	32	60	161	53	213	105	283	175	388	280	458	350	528	420	QTS100S-3400-[ejecución de longitud]-ZYL32-MN
35	35,00 - 35,99	32	60	163	54	218	108	289	180	397	288	469	360	541	432	QTS100S-3500-[ejecución de longitud]-ZYL32-MN
36	36,00 - 36,99	32	60	166	56	222	111	295	185	406	296	480	370	554	444	QTS100S-3600-[ejecución de longitud]-ZYL32-MN
37	37,00 - 38,99	40	70	182	59	240	117	318	195	435	312	515	390	591	468	QTS100S-3700-[ejecución de longitud]-ZYL40-MN
39	39,00 - 40,99	40	70	187	62	249	123	330	205	453	328	537	410	617	492	QTS100S-3900-[ejecución de longitud]-ZYL40-MN
41	41,00 - 42,99	40	70	193	65	257	129	343	215	472	344	560	430	644	516	QTS100S-4100-[ejecución de longitud]-ZYL40-MN
43	43,00 - 44,99	40	70	198	68	265	135	355	225	490	360	582	440	670	540	QTS100S-4300-[ejecución de longitud]-ZYL40-MN
45	45,00 - 46,99	40	70	203	71	274	141	367	235	508	376	604	470	696	564	QTS100S-4500-[ejecución de longitud]-ZYL40-MN
47	47,00 - 48,99	40	70	211	74	284	147	382	245	529	392	627	490	725	588	QTS100S-4700-[ejecución de longitud]-ZYL40-MN
49	49,00 - 50,99	40	70	216	77	293	153	394	255	547	408	649	510	751	612	QTS100S-4900-[ejecución de longitud]-ZYL40-MN

Medidas en mm.

Ejecuciones especiales a petición.

Refacciones

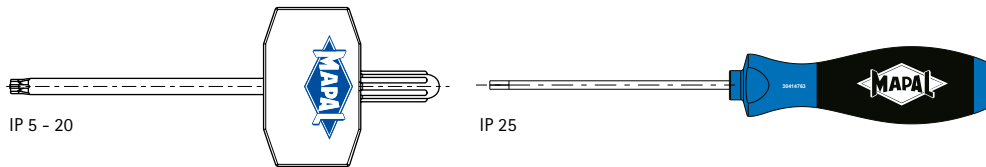

Destornillador

Tamaño Torx TORX® PLUS	Referencia
5 IP	30584281
6 IP	30584282
7 IP	30584283
8 IP	30584284
9 IP	30584285
10 IP	30584286
15 IP	30584287
20 IP	30584288
25 IP	30414767

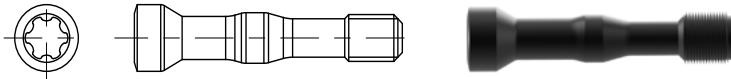

Tornillo de sujeción

Rango de Ø	Tamaño TORX® PLUS	Referencia	Especificación	Par de apriete [Nm]
8,00 - 8,99	5 IP	30604440	M1.2X7.5-TX5-IP	0,2
9,00 - 10,99	5 IP	30546309	M1.2X8.5-TX5-IP	0,2
11,00 - 12,99	6 IP	30604180	M1.6X10.5-TX6-IP	0,4
13,00 - 13,99	7 IP	30510826	M2x12-TX7-IP	0,6
14,00 - 15,99	8 IP	30510827	M2.2x13-TX8-IP	0,9
16,00 - 18,99	8 IP	30495432	M2.5x15-TX8-IP	1,2
19,00 - 21,99	9 IP	30510829	M3x18-TX9-IP	2,2
22,00 - 24,99	10 IP	30510830	M3.5x21-TX10-IP	3,3
25,00 - 27,99	15 IP	30510831	M4x24-TX15-IP	5,0
28,00 - 30,99	15 IP	30510832	M4.5x27-TX15-IP	5,7
31,00 - 32,99	20 IP	30510833	M5x30-TX20-IP	7,5
33,00 - 36,99	20 IP	30651830	M5X32-TX20-IP	7,5
37,00 - 44,99	25 IP	30651399	M6X35-TX25-IP	15,0
45,00 - 50,99	25 IP	30651510	M6X43-TX25-IP	15,0

Recomendación de valores de corte para placas de corte QTD

Avance y velocidad de corte

Tipo 01 – Steel

Grupo de arranque de vi-rutas de Mapal*		Material	Rigidez/dureza [N/mm ²] [HRC]
P	P1	P1.1 Aceros de construcción, para tornos automáticos, de cementación y revenidos, no aleados	< 700
		P1.2 Aceros de construcción, para tornos automáticos, de cementación y revenidos, no aleados	< 1200
	P2	P2.1 Aceros nitrurados, de cementación y aceros revenidos, aleados	< 900
		P2.2 Aceros nitrurados, de cementación y aceros revenidos, aleados	< 1400
	P3	P3.1 Aceros para herramientas, rodamientos, resortes y rápidos**	< 800
		P3.2 Aceros para herramientas, rodamientos, resortes y rápidos**	< 1000
		P3.3 Aceros para herramientas, rodamientos, resortes y rápidos**	< 1500
	P5	P5.1 Fundición de acero	
	K	K1	K1.1 Hierro fundido con grafito laminar (fundición gris), GJL
K2.1 Hierro fundido con grafito esferoidal, GJS			< 500
K2		K2.2 Hierro fundido con grafito esferoidal, GJS	≤ 800
		K2.3 Hierro fundido con grafito esferoidal, GJS	> 800
K3		K3.1 Hierro fundido con grafito vermicular, GJV; fundición maleable, GJM	< 500
		K3.2 Hierro fundido con grafito vermicular, GJV; fundición maleable, GJM	> 500

Tipo 05 – Steel-Pyramid

Grupo de arranque de vi-rutas de Mapal*		Material	Rigidez/dureza [N/mm ²] [HRC]	
P	P1	P1.1 Aceros de construcción, para tornos automáticos, de cementación y revenidos, no aleados	< 700	
		P1.2 Aceros de construcción, para tornos automáticos, de cementación y revenidos, no aleados	< 1200	
	P2	P2.1 Aceros nitrurados, de cementación y aceros revenidos, aleados	< 900	
		P2.2 Aceros nitrurados, de cementación y aceros revenidos, aleados	< 1400	
	P3	P3.1 Aceros para herramientas, rodamientos, resortes y rápidos**	< 800	
		P3.2 Aceros para herramientas, rodamientos, resortes y rápidos**	< 1000	
		P3.3 Aceros para herramientas, rodamientos, resortes y rápidos**	< 1500	
	K	K1	K1.1 Hierro fundido con grafito laminar (fundición gris), GJL	< 300
			K2.1 Hierro fundido con grafito esferoidal, GJS	< 500
K2		K2.2 Hierro fundido con grafito esferoidal, GJS	≤ 800	
		K2.3 Hierro fundido con grafito esferoidal, GJS	> 800	

Tipo 10 – Uni, forma EK

Grupo de arranque de vi-rutas de Mapal*		Material	Rigidez/dureza [N/mm ²] [HRC]
P	P1	P1.1 Aceros de construcción, para tornos automáticos, de cementación y revenidos, no aleados	< 700
		P1.2 Aceros de construcción, para tornos automáticos, de cementación y revenidos, no aleados	< 1200
	P2	P2.1 Aceros nitrurados, de cementación y aceros revenidos, aleados	< 900
		P2.2 Aceros nitrurados, de cementación y aceros revenidos, aleados	< 1400
	P3	P3.1 Aceros para herramientas, rodamientos, resortes y rápidos**	< 800
		P3.2 Aceros para herramientas, rodamientos, resortes y rápidos**	< 1000
		P3.3 Aceros para herramientas, rodamientos, resortes y rápidos**	< 1500
	P5	P5.1 Fundición de acero	
	K	K1	K1.1 Hierro fundido con grafito laminar (fundición gris), GJL
K2		K2.1 Hierro fundido con grafito esferoidal, GJS	< 500

* Grupos de mecanizado MAPAL

** Si los componentes de aleación de Cr, Mo, Ni, V, W suman > 8 %, elegir el siguiente grupo de mecanizado MAPAL superior.

	Velocidad de corte v_c [m/min]				Avance f [mm] con diámetro de broca					
	Refrigeración interna	Refrigeración exterior	MMS	Aire	8,00	11,50	16,50	24,00	34,50	50,00
	100	90	90		0,20	0,26	0,31	0,36	0,38	0,39
	90	75	75		0,25	0,32	0,39	0,45	0,47	0,49
	100	85	85		0,24	0,30	0,37	0,43	0,45	0,46
	70	60	60		0,19	0,24	0,29	0,34	0,35	0,36
	75	65	65		0,22	0,27	0,33	0,38	0,40	0,42
	60	55	55		0,18	0,22	0,27	0,31	0,33	0,34
	60	45	50		0,14	0,18	0,21	0,24	0,25	0,26
	100	85	85		0,24	0,30	0,37	0,43	0,45	0,46
	95	70	70	70	0,25	0,33	0,41	0,47	0,49	0,51
	130	80	95	95	0,24	0,30	0,37	0,43	0,46	0,47
	80	60	60		0,21	0,26	0,32	0,37	0,39	0,40
	50	30	40		0,14	0,18	0,21	0,24	0,26	0,26
	70	65	65		0,22	0,28	0,35	0,40	0,42	0,43
	65	55	55		0,18	0,23	0,27	0,32	0,33	0,34

	Velocidad de corte v_c [m/min]				Avance f [mm] con diámetro de broca					
	Refrigeración interna	Refrigeración exterior	MMS	Aire	14,00	16,50	19,50	23,00	27,00	32,00
	120	110	110		0,26	0,29	0,31	0,33	0,34	0,34
	110	90	90		0,33	0,36	0,38	0,41	0,42	0,43
	120	100	100		0,31	0,34	0,36	0,38	0,40	0,41
	90	80	80		0,28	0,30	0,33	0,35	0,36	0,37
	95	70	70	70	0,39	0,43	0,46	0,49	0,51	0,52
	110	70	85	85	0,36	0,40	0,43	0,45	0,47	0,48

	Velocidad de corte v_c [m/min]				Avance f [mm] con diámetro de broca					
	Refrigeración interna	Refrigeración exterior	MMS	Aire	10,00	13,00	16,00	21,00	26,00	33,00
	120	110	110		0,22	0,25	0,28	0,31	0,34	0,35
	110	90	90		0,27	0,31	0,35	0,39	0,42	0,43
	120	100	100		0,25	0,29	0,33	0,37	0,40	0,41
	90	80	80		0,23	0,26	0,30	0,33	0,36	0,37
	95	70	70	70	0,31	0,36	0,42	0,47	0,51	0,52
	110	70	85	85	0,29	0,34	0,39	0,43	0,47	0,48

Los valores de corte indicados son de referencia.

Los datos óptimos para cada situación de mecanizado deben determinarse mediante ensayos o durante el propio proceso de mecanizado.

Recomendación de valores de corte para placas de corte QTD

Avance y velocidad de corte

Tipo 02 – Inox

Grupo de arranque de vi-rutas de Mapal*		Material	Rigidez/dureza [N/mm ²] [HRC]	
P	P1	P1.1 Aceros de construcción, para tornos automáticos, de cementación y revenidos, no aleados	< 700	
		P1.2 Aceros de construcción, para tornos automáticos, de cementación y revenidos, no aleados	< 1200	
	P2	P2.1 Aceros nitrurados, de cementación y aceros revenidos, aleados	< 900	
		P2.2 Aceros nitrurados, de cementación y aceros revenidos, aleados	< 1400	
	P3	P3.1 Aceros para herramientas, rodamientos, resortes y rápidos**	< 800	
		P3.2 Aceros para herramientas, rodamientos, resortes y rápidos**	< 1000	
		P3.3 Aceros para herramientas, rodamientos, resortes y rápidos**	< 1500	
	P4	P4.1 Aceros inoxidables, ferríticos y martensíticos		
	P5	P5.1 Fundición de acero		
	P6	P6.1 Fundición de acero inoxidable, ferrítica y martensítica		
M	M1	M1.1 Aceros inoxidables, austeníticos	< 700	
		M1.2 Aceros inoxidables, ferríticos/austeníticos (dúplex)	< 1000	
	M2	M2.1 Fundición de acero inoxidable, austenítica	< 700	
	M3	M3.1 Fundición de acero inoxidable, ferrítica/austenítica (dúplex)	< 1000	
K	K1	K1.1 Hierro fundido con grafito laminar (fundición gris), GJL	< 300	
		K2.1 Hierro fundido con grafito esferoidal, GJS	< 500	
		K2.2 Hierro fundido con grafito esferoidal, GJS	≤ 800	
	K2	K2.3 Hierro fundido con grafito esferoidal, GJS	> 800	
		K3.1	K3.1 Hierro fundido con grafito vermicular, GJV; fundición maleable, GJM	< 500
			K3.2 Hierro fundido con grafito vermicular, GJV; fundición maleable, GJM	> 500

Tipo 03 – Alu

Grupo de arranque de vi-rutas de Mapal*		Material	Rigidez/dureza [N/mm ²] [HRC]
N	N1	N1.1 Aluminio, aleado y no aleado < 3 % Si	
		N1.2 Aluminio, aleado ≤ 7 % Si	
		N1.3 Aluminio, aleado > 7-12 % Si	
		N1.4 Aluminio, aleado > 12 % Si	
	N2	N2.1 Cobre, no aleado y de baja aleación	< 300
		N2.2 Cobre, aleado	> 300
		N2.3 Latón, bronce, fundición roja	< 1200

Tipo 04 – Iron

Grupo de arranque de vi-rutas de Mapal*		Material	Rigidez/dureza [N/mm ²] [HRC]	
K	K1	K1.1 Hierro fundido con grafito laminar (fundición gris), GJL	< 300	
		K2.1 Hierro fundido con grafito esferoidal, GJS	< 500	
		K2.2 Hierro fundido con grafito esferoidal, GJS	≤ 800	
	K2	K2.3 Hierro fundido con grafito esferoidal, GJS	> 800	
		K3.1	K3.1 Hierro fundido con grafito vermicular, GJV; fundición maleable, GJM	< 500
			K3.2 Hierro fundido con grafito vermicular, GJV; fundición maleable, GJM	> 500

* Grupos de mecanizado MAPAL

** Si los componentes de aleación de Cr, Mo, Ni, V, W suman > 8 %, elegir el siguiente grupo de mecanizado MAPAL superior.

	Velocidad de corte v_c [m/min]				Avance f [mm] con diámetro de broca					
	Refrigeración interna	Refrigeración exterior	MMS	Aire	9,00	12,00	16,00	21,00	27,50	36,00
	100	90	90		0,19	0,23	0,27	0,30	0,32	0,33
	90	75	75		0,24	0,29	0,34	0,38	0,40	0,41
	100	85	85		0,23	0,27	0,32	0,36	0,38	0,39
	70	60	60		0,18	0,22	0,25	0,28	0,30	0,31
	75	65	65		0,20	0,24	0,29	0,32	0,34	0,35
	60	55	55		0,17	0,20	0,23	0,26	0,28	0,29
	60	45	50		0,13	0,16	0,18	0,20	0,21	0,22
	60	45	50		0,13	0,16	0,19	0,21	0,23	0,23
	100	85	85		0,23	0,27	0,32	0,36	0,38	0,39
	60	45	50		0,13	0,16	0,19	0,21	0,23	0,23
	55	35	35		0,15	0,18	0,22	0,24	0,26	0,27
	50	30	30		0,13	0,16	0,19	0,21	0,22	0,23
	55	35	35		0,15	0,18	0,22	0,24	0,26	0,27
	50	30	30		0,13	0,16	0,19	0,21	0,22	0,23
	110	75	75	75	0,27	0,34	0,40	0,45	0,49	0,50
	145	90	110	110	0,26	0,31	0,37	0,42	0,45	0,46
	90	70	70		0,22	0,27	0,32	0,36	0,38	0,39
	55	35	45		0,15	0,18	0,21	0,23	0,25	0,26
	80	70	70		0,24	0,29	0,34	0,38	0,41	0,42
	70	65	65		0,19	0,23	0,27	0,30	0,33	0,33

	Velocidad de corte v_c [m/min]				Avance f [mm] con diámetro de broca					
	Refrigeración interna	Refrigeración exterior	MMS	Aire	9,00	12,00	16,00	21,00	27,50	36,00
	300	200	250		0,19	0,23	0,27	0,30	0,32	0,33
	250	180	200		0,25	0,30	0,35	0,40	0,43	0,43
	220	150	180		0,25	0,30	0,35	0,40	0,43	0,43
	180	120	150		0,25	0,30	0,35	0,40	0,43	0,43
	140	100			0,19	0,23	0,27	0,30	0,32	0,33
	120	90			0,25	0,30	0,35	0,40	0,43	0,43
	200	160	160	120	0,30	0,37	0,44	0,50	0,54	0,55

	Velocidad de corte v_c [m/min]				Avance f [mm] con diámetro de broca					
	Refrigeración interna	Refrigeración exterior	MMS	Aire	9,00	12,00	16,00	21,00	27,50	36,00
	120	85	85	85	0,37	0,45	0,53	0,60	0,65	0,66
	160	100	120	120	0,34	0,42	0,49	0,55	0,59	0,61
	100	75	75		0,30	0,36	0,42	0,48	0,51	0,52
	60	40	50		0,20	0,24	0,28	0,31	0,34	0,34
	90	80	80		0,32	0,39	0,46	0,51	0,55	0,56
	80	70	70		0,26	0,31	0,36	0,40	0,43	0,44

Los valores de corte indicados son de referencia.

Los datos óptimos para cada situación de mecanizado deben determinarse mediante ensayos o durante el propio proceso de mecanizado.

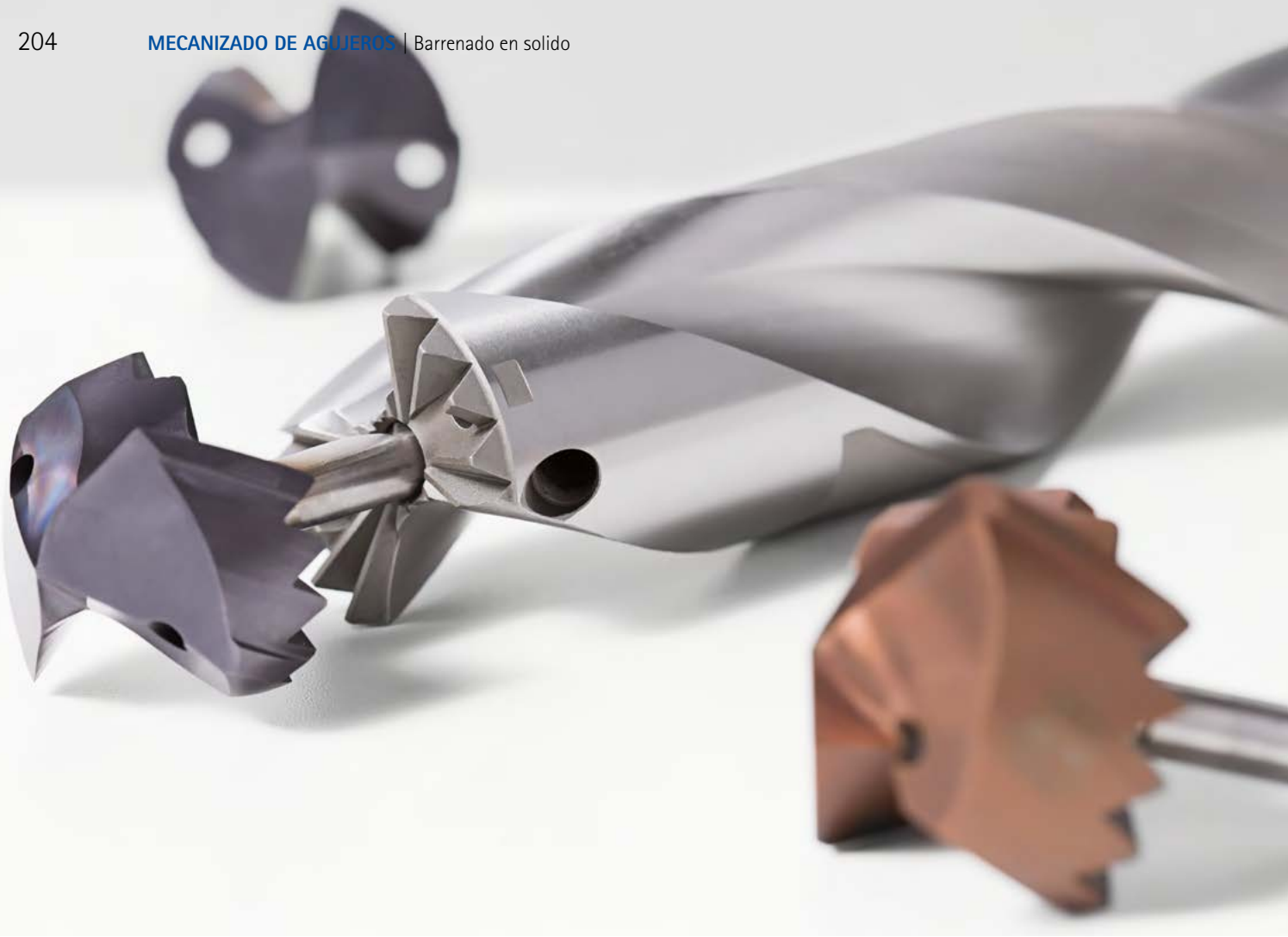

BROCA DE CABEZAL INTERCAMBIABLE TTD

Uso minimizado de metal duro con la máxima estabilidad y precisión

La broca de cabezal intercambiable TTD alcanza el nivel de rendimiento y calidad de las brocas fabricadas íntegramente en metal duro. Al mismo tiempo, el uso de metal duro, reducido a los cabezales de taladrado intercambiables, permite reducir los costes de las herramientas.

En el centro de la broca de cabezal intercambiable TTD está la unión TTS (Torque Transfer System), que garantiza una unión muy estable.

Se caracteriza por una transmisión óptima del par y altas precisiones de cambio y concentricidad.

Las series estándar de la broca de cabezal intercambiable TTD comprenden las profundidades de taladrado 1xD, 3xD, 5xD, 8xD y 12xD. Con cinco cabezales de taladrado intercambiables se cubren también las tareas de mecanizado problemáticas en casi todos los materiales, en el rango de diámetro de 12 a 45 mm.

Los cabezales de taladrado presentan una óptima capacidad de centraje y las virutas se evacuan con seguridad a través de los espacios para virutas del soporte TTS mediante elafilado de caras especial. Además, se favorece una marcha muy suave del taladro gracias a la geometría de tres o cuatro biseles. La combinación de estas propiedades permite una larga vida útil y unos resultados de taladrado del más alto nivel.

Características detalladas de la herramienta

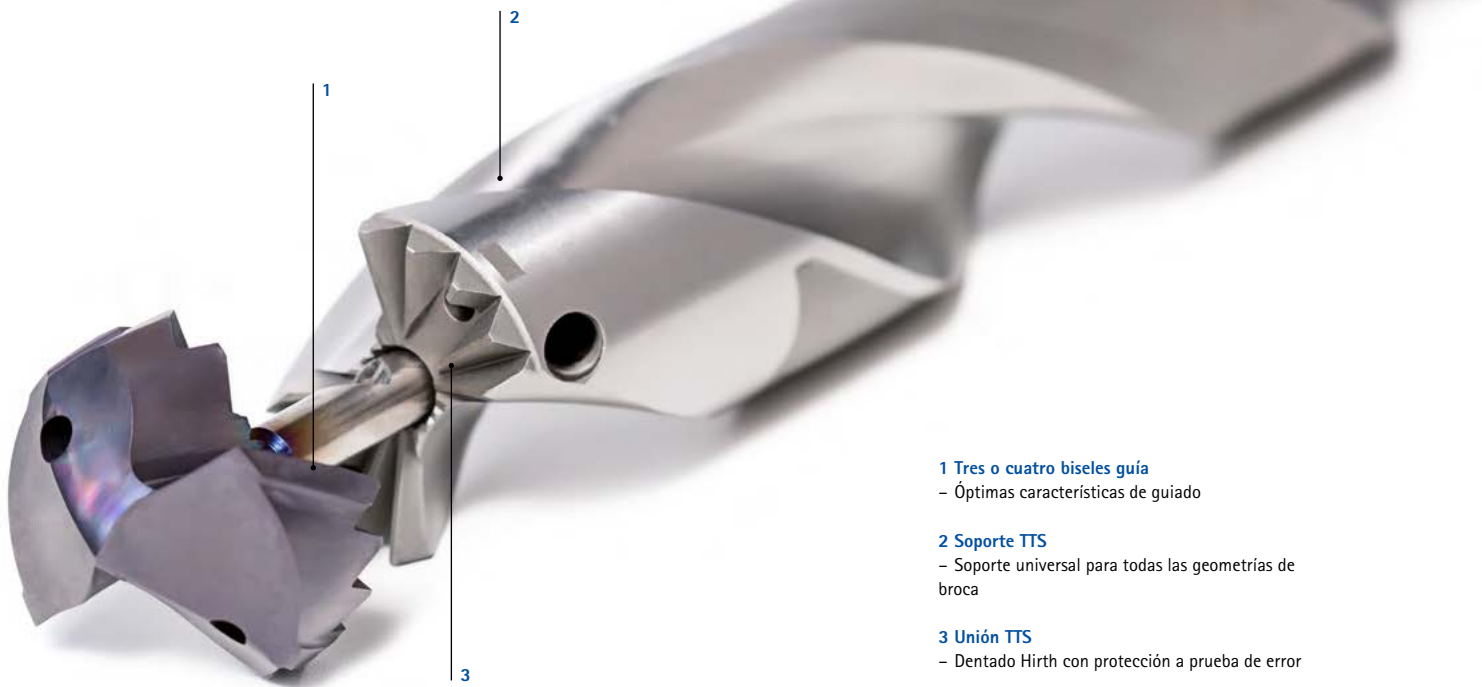

1 Tres o cuatro biseles guía

- Óptimas características de guiado

2 Soporte TTS

- Soporte universal para todas las geometrías de broca

3 Unión TTS

- Dentado Hirth con protección a prueba de error



RESUMEN

- Suministro de almacén
- Rango de \varnothing de 12,00 a 45,00 mm
- Profundidades de taladrado 1 | 3 | 5 | 8 y 12xD
- Con refrigeración interna
- Manejo sencillo
- Posibilidad de realizar el cambio de cabezal en la máquina

CARACTERÍSTICAS DE RENDIMIENTO

- Mismo rendimiento que las brocas de metal duro (MD)
- Alta precisión de concentricidad
- Buena precisión de posicionamiento
- Alta transmisión del par

VENTAJAS

- Puede reafilarse si es necesario
- Cambio de cabezal con protección a prueba de error
- Un soporte para diferentes cabezales intercambiables de taladrado
- Pueden llevarse a cabo casi todas las geometrías de taladrado

Cabezal de taladrado intercambiable TTD

De metal duro, suministro de refrigerante interior
 Tipo 01 – Uni-Plus

Ejecución:
 Diámetro de broca: 12,00 – 45,00 mm
 Tolerancia del agujero: ≥ IT 9
 Material de corte: HP358
 Número de insertos: 2
 Número de bisel guía: 4
 Ángulo de la punta: 140°

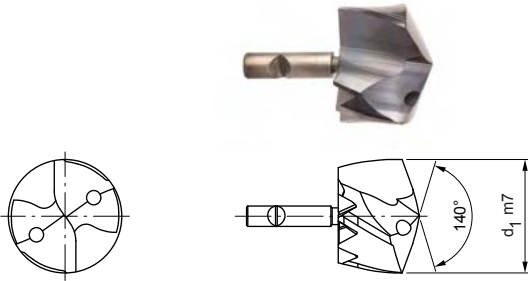

Serie preferente disponible en stock

d ₁ de 12,00 a 21,00		
d ₁ m7	Especificación	Referencia
12,00	TTD-4F01P-1200-HP358	31164086
13,50	TTD-4F01P-1350-HP358	31164141
14,00	TTD-4F01P-1400-HP358	31164146
14,50	TTD-4F01P-1450-HP358	31164151
15,00	TTD-4F01P-1500-HP358	31164156
15,50	TTD-4F01P-1550-HP358	31164161
15,60	TTD-4F01P-1560-HP358	31164162
15,80	TTD-4F01P-1580-HP358	31164164
16,00	TTD-4F01P-1600-HP358	31164166
16,50	TTD-4F01P-1650-HP358	31164171
17,00	TTD-4F01P-1700-HP358	31164176
17,50	TTD-4F01P-1750-HP358	31164181
17,70	TTD-4F01P-1770-HP358	31164183
17,80	TTD-4F01P-1780-HP358	31164184
18,00	TTD-4F01P-1800-HP358	31164186
18,50	TTD-4F01P-1850-HP358	31164191
18,80	TTD-4F01P-1880-HP358	31164194
19,00	TTD-4F01P-1900-HP358	31164196
19,50	TTD-4F01P-1950-HP358	31164201
19,70	TTD-4F01P-1970-HP358	31164203
20,00	TTD-4F01P-2000-HP358	31164206
20,50	TTD-4F01P-2050-HP358	31164211
21,00	TTD-4F01P-2100-HP358	31164216

d ₁ de 21,50 a 40,00		
d ₁ m7	Especificación	Referencia
21,50	TTD-4F01P-2150-HP358	31164221
22,00	TTD-4F01P-2200-HP358	31164226
22,50	TTD-4F01P-2250-HP358	31164231
23,00	TTD-4F01P-2300-HP358	31164236
24,00	TTD-4F01P-2400-HP358	31164246
24,50	TTD-4F01P-2450-HP358	31164251
25,00	TTD-4F01P-2500-HP358	31164256
25,40	TTD-4F01P-2540-HP358	31164260
25,50	TTD-4F01P-2550-HP358	31164261
26,00	TTD-4F01P-2600-HP358	31164266
26,50	TTD-4F01P-2650-HP358	31164271
27,00	TTD-4F01P-2700-HP358	31164276
28,00	TTD-4F01P-2800-HP358	31164286
28,50	TTD-4F01P-2850-HP358	31164291
30,00	TTD-4F01P-3000-HP358	31164306
30,70	TTD-4F01P-3070-HP358	31164313
31,00	TTD-4F01P-3100-HP358	31164316
32,00	TTD-4F01P-3200-HP358	31164326
33,00	TTD-4F01P-3300-HP358	31164328
37,00	TTD-4F01P-3700-HP358	31164336
38,50	TTD-4F01P-3850-HP358	31164339
39,00	TTD-4F01P-3900-HP358	31164340
40,00	TTD-4F01P-4000-HP358	31164342

Características configurables



Diámetro:
 Diámetro seleccionable libremente en incrementos de 0,01 mm

Especificación
 TTD-4F01P-[diámetro]-HP358

Dimensiones de la serie configurable

d ₁ min.	d ₁ máx.
12,00	45,00

Ejemplo:
 TTD-4F01P-1401-HP358

Diámetro de la herramienta d₁ = 14,01 mm

Medidas en mm.
 Ejecuciones especiales a petición.

Cabezal de taladrado intercambiable TTD

De metal duro, suministro de refrigerante interior
Tipo 04 – Steel

Ejecución:

Diámetro de broca: 12,00 – 45,00 mm
Tolerancia del agujero: \geq IT 9
Material de corte: HP358
Número de insertos: 2
Número de bisel guía: 3
Ángulo de la punta: 138°

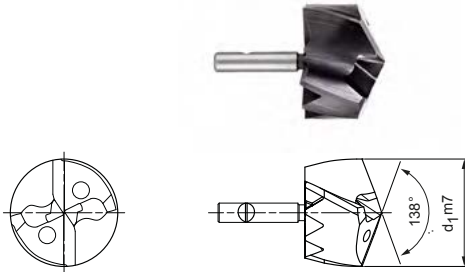

Serie preferente disponible en stock

d ₁ de 12,00 a 17,00		
d ₁ m7	Especificación	Referencia
12,00	TTD-3F04-1200-HP358	30530406
12,10	TTD-3F04-1210-HP358	30596953
12,20	TTD-3F04-1220-HP358	30596954
12,50	TTD-3F04-1250-HP358	30530407
12,80	TTD-3F04-1280-HP358	30596958
13,00	TTD-3F04-1300-HP358	30530409
13,10	TTD-3F04-1310-HP358	30596960
13,20	TTD-3F04-1320-HP358	30596961
13,50	TTD-3F04-1350-HP358	30530410
14,00	TTD-3F04-1400-HP358	30530412
14,10	TTD-3F04-1410-HP358	30596967
14,20	TTD-3F04-1420-HP358	30596968
14,30	TTD-3F04-1430-HP358	30596969
14,40	TTD-3F04-1440-HP358	30596970
14,50	TTD-3F04-1450-HP358	30530413
14,70	TTD-3F04-1470-HP358	30530414
14,80	TTD-3F04-1480-HP358	30596972
15,00	TTD-3F04-1500-HP358	30530415
15,10	TTD-3F04-1510-HP358	30596974
15,20	TTD-3F04-1520-HP358	30596975
15,50	TTD-3F04-1550-HP358	30530416
15,70	TTD-3F04-1570-HP358	30530417
15,80	TTD-3F04-1580-HP358	30596979
16,00	TTD-3F04-1600-HP358	30530418
16,10	TTD-3F04-1610-HP358	30596981
16,20	TTD-3F04-1620-HP358	30596982
16,30	TTD-3F04-1630-HP358	30596983
16,40	TTD-3F04-1640-HP358	30596984
16,50	TTD-3F04-1650-HP358	30530419
16,60	TTD-3F04-1660-HP358	30596985
16,70	TTD-3F04-1670-HP358	30530420
16,80	TTD-3F04-1680-HP358	30596986
17,00	TTD-3F04-1700-HP358	30530421

d ₁ de 17,10 a 21,40		
d ₁ m7	Especificación	Referencia
17,10	TTD-3F04-1710-HP358	30596988
17,30	TTD-3F04-1730-HP358	30596990
17,50	TTD-3F04-1750-HP358	30530422
17,60	TTD-3F04-1760-HP358	30596992
17,70	TTD-3F04-1770-HP358	30530423
17,80	TTD-3F04-1780-HP358	30596993
18,00	TTD-3F04-1800-HP358	30530424
18,10	TTD-3F04-1810-HP358	30596995
18,20	TTD-3F04-1820-HP358	30596996
18,30	TTD-3F04-1830-HP358	30596997
18,40	TTD-3F04-1840-HP358	30596998
18,50	TTD-3F04-1850-HP358	30530425
18,80	TTD-3F04-1880-HP358	30597000
18,90	TTD-3F04-1890-HP358	30597001
19,00	TTD-3F04-1900-HP358	30530427
19,20	TTD-3F04-1920-HP358	30597003
19,30	TTD-3F04-1930-HP358	30597004
19,50	TTD-3F04-1950-HP358	30530428
19,70	TTD-3F04-1970-HP358	30530429
19,80	TTD-3F04-1980-HP358	30597007
19,90	TTD-3F04-1990-HP358	30597008
20,00	TTD-3F04-2000-HP358	30530431
20,10	TTD-3F04-2010-HP358	30597009
20,20	TTD-3F04-2020-HP358	30597010
20,30	TTD-3F04-2030-HP358	30597011
20,40	TTD-3F04-2040-HP358	30597012
20,50	TTD-3F04-2050-HP358	30530432
20,60	TTD-3F04-2060-HP358	30597013
20,70	TTD-3F04-2070-HP358	30530433
21,00	TTD-3F04-2100-HP358	30530434
21,10	TTD-3F04-2110-HP358	30597016
21,20	TTD-3F04-2120-HP358	30597017
21,40	TTD-3F04-2140-HP358	30597019

Continúa en la página siguiente.

Cabezal de taladrado intercambiable TTD de metal duro, suministro de refrigerante interior – Tipo 04

d ₁ de 21,50 a 26,10			d ₁ de 26,20 a 41,00		
d ₁ m7	Especificación	Referencia	d ₁ m7	Especificación	Referencia
21,50	TTD-3F04-2150-HP358	30530435	26,20	TTD-3F04-2620-HP358	30597052
21,70	TTD-3F04-2170-HP358	30530436	26,50	TTD-3F04-2650-HP358	30530450
21,80	TTD-3F04-2180-HP358	30597021	26,70	TTD-3F04-2670-HP358	30530451
22,00	TTD-3F04-2200-HP358	30530437	27,00	TTD-3F04-2700-HP358	30530452
22,10	TTD-3F04-2210-HP358	30597023	27,50	TTD-3F04-2750-HP358	30530453
22,20	TTD-3F04-2220-HP358	30597024	27,70	TTD-3F04-2770-HP358	30530454
22,30	TTD-3F04-2230-HP358	30597025	27,80	TTD-3F04-2780-HP358	30597063
22,40	TTD-3F04-2240-HP358	30597026	28,00	TTD-3F04-2800-HP358	30530455
22,50	TTD-3F04-2250-HP358	30530438	28,20	TTD-3F04-2820-HP358	30597066
22,60	TTD-3F04-2260-HP358	30597027	28,30	TTD-3F04-2830-HP358	30597067
22,70	TTD-3F04-2270-HP358	30530439	28,50	TTD-3F04-2850-HP358	30530456
23,00	TTD-3F04-2300-HP358	30530440	29,00	TTD-3F04-2900-HP358	30530458
23,10	TTD-3F04-2310-HP358	30597030	30,00	TTD-3F04-3000-HP358	30530461
23,30	TTD-3F04-2330-HP358	30597032	30,30	TTD-3F04-3030-HP358	30597082
23,50	TTD-3F04-2350-HP358	30530441	30,50	TTD-3F04-3050-HP358	30530462
23,70	TTD-3F04-2370-HP358	30530442	31,00	TTD-3F04-3100-HP358	30530464
24,00	TTD-3F04-2400-HP358	30530443	31,50	TTD-3F04-3150-HP358	30530465
24,40	TTD-3F04-2440-HP358	30597040	31,70	TTD-3F04-3170-HP358	30530466
24,50	TTD-3F04-2450-HP358	30530444	32,00	TTD-3F04-3200-HP358	30530467
24,70	TTD-3F04-2470-HP358	30530445	33,00	TTD-3F04-3300-HP358	30530469
24,80	TTD-3F04-2480-HP358	30597042	34,00	TTD-3F04-3400-HP358	30530471
25,00	TTD-3F04-2500-HP358	30530446	34,50	TTD-3F04-3450-HP358	30530472
25,20	TTD-3F04-2520-HP358	30597045	35,00	TTD-3F04-3500-HP358	30530473
25,30	TTD-3F04-2530-HP358	30597046	36,00	TTD-3F04-3600-HP358	30530475
25,40	TTD-3F04-2540-HP358	30597047	37,00	TTD-3F04-3700-HP358	30530477
25,50	TTD-3F04-2550-HP358	30530447	38,00	TTD-3F04-3800-HP358	30530479
25,90	TTD-3F04-2590-HP358	30597050	39,00	TTD-3F04-3900-HP358	30530481
26,00	TTD-3F04-2600-HP358	30530449	40,00	TTD-3F04-4000-HP358	30530483
26,10	TTD-3F04-2610-HP358	30597051	41,00	TTD-3F04-4100-HP358	30530485

Características configurables

**Diámetro:**

Diámetro seleccionable libremente en incrementos de 0,01 mm

**Especificación**

TTD-3F04-[diámetro]-HP358

Dimensiones de la serie configurable

d ₁ mín.	d ₁ máx.
12,00	45,00

Ejemplo:

TTD-3F04-1401-HP358

Diámetro de la herramienta d₁ = 14,01 mm

Medidas en mm.

Para la recomendación de valores de corte, véase al final del capítulo.

Ejecuciones especiales y otros recubrimientos a petición.

Cabezal de taladrado intercambiable TTD

De metal duro, suministro de refrigerante interior
Tipo 02 – Inox

Ejecución:

Diámetro de broca: 12,00 – 45,00 mm
Tolerancia del agujero: $\geq IT 9$
Material de corte: HP385
Número de insertos: 2
Número de bisel guía: 3
Ángulo de la punta: 138°

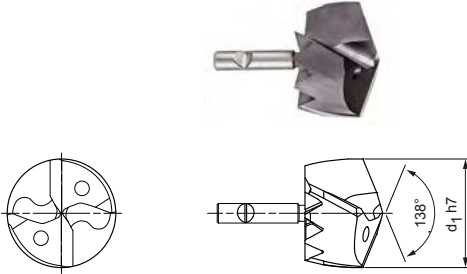

Serie preferente disponible en stock

d ₁ de 12,00 a 16,40		
d ₁ h7	Especificación	Referencia
12,00	TTD-3F02-1200-HP385	30231780
12,10	TTD-3F02-1210-HP385	30248920
12,20	TTD-3F02-1220-HP385	30248921
12,40	TTD-3F02-1240-HP385	30248923
12,50	TTD-3F02-1250-HP385	30231784
12,60	TTD-3F02-1260-HP385	30248924
12,70	TTD-3F02-1270-HP385	30231787
13,00	TTD-3F02-1300-HP385	30231791
13,10	TTD-3F02-1310-HP385	30248927
13,50	TTD-3F02-1350-HP385	30231792
13,80	TTD-3F02-1380-HP385	30248932
14,00	TTD-3F02-1400-HP385	30231795
14,10	TTD-3F02-1410-HP385	30239446
14,20	TTD-3F02-1420-HP385	30248934
14,30	TTD-3F02-1430-HP385	30248935
14,40	TTD-3F02-1440-HP385	30248936
14,50	TTD-3F02-1450-HP385	30231802
14,60	TTD-3F02-1460-HP385	30248937
14,70	TTD-3F02-1470-HP385	30231804
14,80	TTD-3F02-1480-HP385	30248938
15,00	TTD-3F02-1500-HP385	30231805
15,10	TTD-3F02-1510-HP385	30248940
15,30	TTD-3F02-1530-HP385	30248942
15,50	TTD-3F02-1550-HP385	30231806
15,60	TTD-3F02-1560-HP385	30248944
15,70	TTD-3F02-1570-HP385	30219115
15,80	TTD-3F02-1580-HP385	30248945
15,90	TTD-3F02-1590-HP385	30248946
16,00	TTD-3F02-1600-HP385	30191427
16,10	TTD-3F02-1610-HP385	30248947
16,20	TTD-3F02-1620-HP385	30248948
16,30	TTD-3F02-1630-HP385	30248949
16,40	TTD-3F02-1640-HP385	30248950

d ₁ de 16,50 a 21,00		
d ₁ h7	Especificación	Referencia
16,50	TTD-3F02-1650-HP385	30191428
16,60	TTD-3F02-1660-HP385	30248951
16,70	TTD-3F02-1670-HP385	30219122
16,80	TTD-3F02-1680-HP385	30248952
17,00	TTD-3F02-1700-HP385	30191429
17,50	TTD-3F02-1750-HP385	30191430
17,60	TTD-3F02-1760-HP385	30248958
17,70	TTD-3F02-1770-HP385	30219123
17,80	TTD-3F02-1780-HP385	30248959
18,00	TTD-3F02-1800-HP385	30191431
18,20	TTD-3F02-1820-HP385	30248962
18,30	TTD-3F02-1830-HP385	30248963
18,50	TTD-3F02-1850-HP385	30191432
18,60	TTD-3F02-1860-HP385	30248965
18,80	TTD-3F02-1880-HP385	30248966
18,90	TTD-3F02-1890-HP385	30248967
19,00	TTD-3F02-1900-HP385	30191433
19,10	TTD-3F02-1910-HP385	30248968
19,20	TTD-3F02-1920-HP385	30248969
19,30	TTD-3F02-1930-HP385	30248970
19,40	TTD-3F02-1940-HP385	30248971
19,50	TTD-3F02-1950-HP385	30191434
19,70	TTD-3F02-1970-HP385	30219125
19,80	TTD-3F02-1980-HP385	30248973
19,90	TTD-3F02-1990-HP385	30248974
20,00	TTD-3F02-2000-HP385	30191435
20,10	TTD-3F02-2010-HP385	30248975
20,20	TTD-3F02-2020-HP385	30248976
20,30	TTD-3F02-2030-HP385	30248977
20,40	TTD-3F02-2040-HP385	30248978
20,50	TTD-3F02-2050-HP385	30191436
20,70	TTD-3F02-2070-HP385	30219126
21,00	TTD-3F02-2100-HP385	30191437

Continúa en la página siguiente.

Cabezal de taladrado intercambiable TTD de metal duro, suministro de refrigerante interior – Tipo O2

d ₁ de 21,20 a 25,80			d ₁ de 26,00 a 38,50		
d ₁ h7	Especificación	Referencia	d ₁ h7	Especificación	Referencia
21,20	TTD-3F02-2120-HP385	30248982	26,00	TTD-3F02-2600-HP385	30191447
21,50	TTD-3F02-2150-HP385	30191438	26,50	TTD-3F02-2650-HP385	30191448
21,70	TTD-3F02-2170-HP385	30219127	26,80	TTD-3F02-2680-HP385	30249020
21,80	TTD-3F02-2180-HP385	30248986	27,00	TTD-3F02-2700-HP385	30191449
22,00	TTD-3F02-2200-HP385	30191439	27,10	TTD-3F02-2710-HP385	30249022
22,10	TTD-3F02-2210-HP385	30248988	27,40	TTD-3F02-2740-HP385	30249025
22,40	TTD-3F02-2240-HP385	30248990	27,50	TTD-3F02-2750-HP385	30191450
22,50	TTD-3F02-2250-HP385	30191440	28,00	TTD-3F02-2800-HP385	30191451
22,60	TTD-3F02-2260-HP385	30248991	28,10	TTD-3F02-2810-HP385	30249029
22,70	TTD-3F02-2270-HP385	30219128	28,20	TTD-3F02-2820-HP385	30249030
22,80	TTD-3F02-2280-HP385	30248992	28,50	TTD-3F02-2850-HP385	30191452
22,90	TTD-3F02-2290-HP385	30248993	28,60	TTD-3F02-2860-HP385	30249033
23,00	TTD-3F02-2300-HP385	30191441	28,70	TTD-3F02-2870-HP385	30219134
23,50	TTD-3F02-2350-HP385	30191442	29,00	TTD-3F02-2900-HP385	30191453
23,70	TTD-3F02-2370-HP385	30219129	29,50	TTD-3F02-2950-HP385	30191454
24,00	TTD-3F02-2400-HP385	30191443	29,70	TTD-3F02-2970-HP385	30219135
24,20	TTD-3F02-2420-HP385	30249002	29,80	TTD-3F02-2980-HP385	30249041
24,40	TTD-3F02-2440-HP385	30249004	29,90	TTD-3F02-2990-HP385	30249042
24,50	TTD-3F02-2450-HP385	30191444	30,00	TTD-3F02-3000-HP385	30191455
24,70	TTD-3F02-2470-HP385	30219130	30,10	TTD-3F02-3010-HP385	30249043
24,80	TTD-3F02-2480-HP385	30249006	30,30	TTD-3F02-3030-HP385	30249045
25,00	TTD-3F02-2500-HP385	30191445	31,00	TTD-3F02-3100-HP385	30191457
25,20	TTD-3F02-2520-HP385	30249009	31,30	TTD-3F02-3130-HP385	30249052
25,30	TTD-3F02-2530-HP385	30249010	31,50	TTD-3F02-3150-HP385	30191458
25,40	TTD-3F02-2540-HP385	30249011	31,80	TTD-3F02-3180-HP385	30249055
25,50	TTD-3F02-2550-HP385	30191446	32,00	TTD-3F02-3200-HP385	30191459
25,70	TTD-3F02-2570-HP385	30219131	38,50	TTD-3F02-3850-HP385	30322384
25,80	TTD-3F02-2580-HP385	30249013			

Características configurables

**Diámetro:**

Diámetro seleccionable libremente en incrementos de 0,01 mm

**Especificación**

TTD-3F02-[diámetro]-HP358

Dimensiones de la serie configurable

d ₁ mín.	d ₁ máx.
12,00	45,00

Ejemplo:

TTD-3F02-1401-HP358

Diámetro de la herramienta d₁ = 14,01 mm

Medidas en mm.

Para la recomendación de valores de corte, véase al final del capítulo.

Ejecuciones especiales y otros recubrimientos a petición.

Cabezal de taladrado intercambiable TTD

De metal duro, suministro de refrigerante interior
Tipo 05 – Iron

Ejecución:

Diámetro de broca: 12,00 – 45,00 mm
Tolerancia del agujero: \geq IT 9
Material de corte: HP240
Número de insertos: 2
Número de bisel guía: 4
Ángulo de la punta: 140°

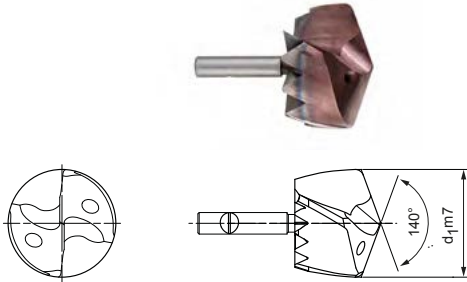

Serie preferente disponible en stock

d ₁ de 12,50 a 20,80		
d ₁ m7	Especificación	Referencia
12,50	TTD-4F05-1250-HP240	30597144
12,70	TTD-4F05-1270-HP240	30597146
14,00	TTD-4F05-1400-HP240	30597159
14,50	TTD-4F05-1450-HP240	30597164
15,30	TTD-4F05-1530-HP240	30597173
15,70	TTD-4F05-1570-HP240	30597177
16,30	TTD-4F05-1630-HP240	30597183
16,50	TTD-4F05-1650-HP240	30597185
16,70	TTD-4F05-1670-HP240	30597187
16,80	TTD-4F05-1680-HP240	30597188
17,00	TTD-4F05-1700-HP240	30597190
17,10	TTD-4F05-1710-HP240	30597191
17,50	TTD-4F05-1750-HP240	30597195
18,00	TTD-4F05-1800-HP240	30597200
18,20	TTD-4F05-1820-HP240	30597202
18,50	TTD-4F05-1850-HP240	30597205
18,60	TTD-4F05-1860-HP240	30597206
18,80	TTD-4F05-1880-HP240	30597208
19,00	TTD-4F05-1900-HP240	30597210
19,70	TTD-4F05-1970-HP240	30597217
20,50	TTD-4F05-2050-HP240	30597225
20,70	TTD-4F05-2070-HP240	30597227
20,80	TTD-4F05-2080-HP240	30597228

d ₁ de 21,00 a 37,00		
d ₁ m7	Especificación	Referencia
21,00	TTD-4F05-2100-HP240	30597230
21,10	TTD-4F05-2110-HP240	30597231
21,50	TTD-4F05-2150-HP240	30597235
21,70	TTD-4F05-2170-HP240	30597237
22,00	TTD-4F05-2200-HP240	30597240
22,10	TTD-4F05-2210-HP240	30597241
22,30	TTD-4F05-2230-HP240	30597243
22,70	TTD-4F05-2270-HP240	30597247
23,00	TTD-4F05-2300-HP240	30597250
23,50	TTD-4F05-2350-HP240	30597255
24,00	TTD-4F05-2400-HP240	30597260
24,40	TTD-4F05-2440-HP240	30597264
24,80	TTD-4F05-2480-HP240	30597268
25,00	TTD-4F05-2500-HP240	30597270
25,80	TTD-4F05-2580-HP240	30597278
26,00	TTD-4F05-2600-HP240	30597280
27,00	TTD-4F05-2700-HP240	30597290
27,10	TTD-4F05-2710-HP240	30597291
28,00	TTD-4F05-2800-HP240	30597300
28,50	TTD-4F05-2850-HP240	30597305
30,00	TTD-4F05-3000-HP240	30597320
32,00	TTD-4F05-3200-HP240	30597341
37,00	TTD-4F05-3700-HP240	30597351

Características configurables



Diámetro:
Diámetro seleccionable libremente en incrementos de 0,01 mm

Especificación
TTD-4F05-[diámetro]-HP240

Dimensiones de la serie configurable

d ₁ mín.	d ₁ máx.
12,00	45,00

Ejemplo:
TTD-4F05-1401-HP619

Diámetro de la herramienta d₁ = 14,01 mm

Medidas en mm.

Para la recomendación de valores de corte, véase al final del capítulo.
Ejecuciones especiales y otros recubrimientos a petición.

Cabezal de taladrado intercambiable TTD

De metal duro, suministro de refrigerante interior
Tipo 03 – Alu

Ejecución:
 Diámetro de broca: 12,00 – 45,00 mm
 Tolerancia del agujero: ≥ IT 9
 Material de corte: HP685
 Número de insertos: 2
 Número de bisel guía: 4
 Ángulo de la punta: 140°

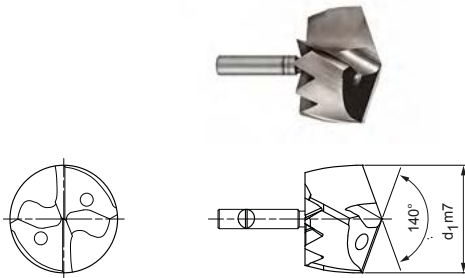

Serie preferente disponible en stock

d ₁ de 12,10 a 21,00		
d ₁ m7	Especificación	Referencia
12,10	TTD-4F03-1210-HP685	30249057
12,50	TTD-4F03-1250-HP685	30231808
12,80	TTD-4F03-1280-HP685	30249062
13,00	TTD-4F03-1300-HP685	30231812
13,50	TTD-4F03-1350-HP685	30231815
14,00	TTD-4F03-1400-HP685	30231817
14,50	TTD-4F03-1450-HP685	30231818
14,70	TTD-4F03-1470-HP685	30231819
14,90	TTD-4F03-1490-HP685	30249077
15,00	TTD-4F03-1500-HP685	30231820
16,00	TTD-4F03-1600-HP685	30191460
16,10	TTD-4F03-1610-HP685	30249085
16,50	TTD-4F03-1650-HP685	30191461
17,00	TTD-4F03-1700-HP685	30191462
17,50	TTD-4F03-1750-HP685	30191463
18,00	TTD-4F03-1800-HP685	30191464
18,10	TTD-4F03-1810-HP685	30234210
18,20	TTD-4F03-1820-HP685	30249099
18,30	TTD-4F03-1830-HP685	30249100
18,50	TTD-4F03-1850-HP685	30191465
18,60	TTD-4F03-1860-HP685	30249102
18,70	TTD-4F03-1870-HP685	30219141
19,00	TTD-4F03-1900-HP685	30191466
19,50	TTD-4F03-1950-HP685	30191467
19,60	TTD-4F03-1960-HP685	30249109
20,00	TTD-4F03-2000-HP685	30191468
20,30	TTD-4F03-2030-HP685	30216431
20,50	TTD-4F03-2050-HP685	30191469
21,00	TTD-4F03-2100-HP685	30191470

d ₁ de 21,50 a 43,00		
d ₁ m7	Especificación	Referencia
21,50	TTD-4F03-2150-HP685	30191471
22,00	TTD-4F03-2200-HP685	30191472
22,50	TTD-4F03-2250-HP685	30191473
22,60	TTD-4F03-2260-HP685	30249129
23,00	TTD-4F03-2300-HP685	30191474
23,50	TTD-4F03-2350-HP685	30191475
23,90	TTD-4F03-2390-HP685	30249138
24,00	TTD-4F03-2400-HP685	30191476
24,10	TTD-4F03-2410-HP685	30249139
24,40	TTD-4F03-2440-HP685	30249142
24,50	TTD-4F03-2450-HP685	30191477
25,00	TTD-4F03-2500-HP685	30191478
25,10	TTD-4F03-2510-HP685	30249146
25,20	TTD-4F03-2520-HP685	30249147
25,50	TTD-4F03-2550-HP685	30191479
26,00	TTD-4F03-2600-HP685	30191480
26,40	TTD-4F03-2640-HP685	30249156
27,00	TTD-4F03-2700-HP685	30191482
27,50	TTD-4F03-2750-HP685	30191483
28,00	TTD-4F03-2800-HP685	30191484
28,30	TTD-4F03-2830-HP685	30249169
28,40	TTD-4F03-2840-HP685	30249170
29,50	TTD-4F03-2950-HP685	30191487
31,00	TTD-4F03-3100-HP685	30191490
31,20	TTD-4F03-3120-HP685	30249189
32,00	TTD-4F03-3200-HP685	30191492
35,00	TTD-4F03-3500-HP685	30322405
43,00	TTD-4F03-4300-HP685	30322423

Características configurables



Diámetro:
Diámetro seleccionable libremente en incrementos de 0,01 mm

Especificación
TTD-4F03-[diámetro]-HP685

Dimensiones de la serie configurable

d ₁ mín.	d ₁ máx.
12.00	45.00

Ejemplo:
TTD-4F03-1401-HP685

Diámetro de la herramienta d₁ = 14,01 mm

Medidas en mm.
Para la recomendación de valores de corte, véase al final del capítulo.
Ejecuciones especiales y otros recubrimientos a petición.

Portaherramientas para cabezal intercambiable TTS

Con sistema de amarre frontal para broca de cabezal intercambiable TTD TTS100, con suministro de refrigerante interior

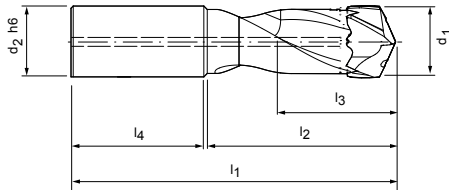

Ejecución:

Para diámetro de broca: 12,00 - 45,49 mm

Sistema de cambio: Sistema de amarre frontal
Posibilidad de realizar el cambio de cabezal en la máquina

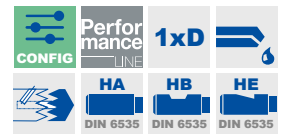

Serie preferente disponible en stock

Dimensiones							Forma del mango HB	
d ₁	Interfaz	d ₂ h6	l ₁	l ₂	l ₃	l ₄	Especificación	Referencia
12,00-12,49	TTS12-S	14	81	29	13	45	TTS100-12-DR1-1200-14-HB	30324304
12,50-12,99	TTS12-S	14	81	29	13	45	TTS100-12-DR1-1250-14-HB	30324305
13,00-13,49	TTS12-S	14	81	31	14	45	TTS100-12-DR1-1300-14-HB	30324306
13,50-13,99	TTS12-S	16	86	32	14	48	TTS100-12-DR1-1350-16-HB	30324307
14,00-14,49	TTS12-S	16	86	33	15	48	TTS100-12-DR1-1400-16-HB	30324308
14,50-14,99	TTS12-S	16	91	34	15	48	TTS100-12-DR1-1450-16-HB	30324309
15,00-15,49	TTS12-S	16	91	36	16	48	TTS100-12-DR1-1500-16-HB	30324310
15,50-16,49	TTS12-S	18	92	38	17	48	TTS100-12-DR1-1550-18-HB	30324311
16,50-17,49	TTS12-S	18	94	40	18	48	TTS100-12-DR1-1650-18-HB	30324312
17,50-18,49	TTS12-S	18	99	43	19	48	TTS100-12-DR1-1750-18-HB	30324313
18,50-19,49	TTS12-S	20	99	45	20	50	TTS100-12-DR1-1850-20-HB	30324314
19,50-20,49	TTS12-S	20	104	47	21	50	TTS100-12-DR1-1950-20-HB	30324316
20,50-21,49	TTS12-S	25	111	49	22	56	TTS100-12-DR1-2050-25-HB	30324317
21,50-22,49	TTS12-S	25	116	52	23	56	TTS100-12-DR1-2150-25-HB	30324318
22,50-23,49	TTS12-S	25	116	54	24	56	TTS100-12-DR1-2250-25-HB	30324319
23,50-24,49	TTS12-S	25	121	56	25	56	TTS100-12-DR1-2350-25-HB	30324320
24,50-25,49	TTS18-S	25	123	59	26	56	TTS100-18-DR1-2450-25-HB	30324321
25,50-26,49	TTS18-S	25	123	61	27	56	TTS100-18-DR1-2550-25-HB	30324322
26,50-27,49	TTS18-S	25	128	63	28	56	TTS100-18-DR1-2650-25-HB	30324323
27,50-28,49	TTS18-S	25	128	66	29	56	TTS100-18-DR1-2750-25-HB	30324325
28,50-29,49	TTS18-S	32	134	68	30	60	TTS100-18-DR1-2850-32-HB	30324327
29,50-30,49	TTS18-S	32	139	70	31	60	TTS100-18-DR1-2950-32-HB	30324328
30,50-31,49	TTS18-S	32	139	75	32	60	TTS100-18-DR1-3050-32-HB	30324329
31,50-32,49	TTS18-S	32	139	75	33	60	TTS100-18-DR1-3150-32-HB	30324330
32,50-33,49	TTS18-S	32	150	78	34	60	TTS100-18-DR1-3250-32-HB	30374587
33,50-34,49	TTS18-S	32	150	79	35	60	TTS100-18-DR1-3350-32-HB	30374590
34,50-35,49	TTS12-S	32	152	86	36	60	TTS100-18-DR1-3550-32-HB	30496703
34,50-35,49	TTS18-S	32	150	82	36	60	TTS100-18-DR1-3450-32-HB	30374593
35,50-37,49	TTS18-S	40	162	86	38	70	TTS100-18-DR1-3550-40-HB	30535302
37,50-39,49	TTS18-S	32	157	91	40	60	TTS100-18-DR1-3750-32-HB	30496704
37,50-39,49	TTS18-S	40	167	71	40	70	TTS100-18-DR1-3750-40-HB	30535303

Continúa en la página siguiente.

Portaherramientas para cabezal intercambiable TTS 100, con suministro de refrigerante interior

Dimensiones							Forma del mango HB	
d ₁	Interfaz	d ₂ h6	l ₁	l ₂	l ₃	l ₄	Especificación	Referencia
39,50-41,49	TTS18-S	32	167	95	42	60	TTS100-18-DR1-3950-32-HB	30496705
39,50-41,49	TTS18-S	40	177	95	42	70	TTS100-18-DR1-3950-40-HB	30535305
41,50-43,49	TTS18-S	40	180	100	44	70	TTS100-18-DR1-4150-40-HB	30535307
43,50-45,49	TTS18-S	40	185	105	46	70	TTS100-18-DR1-4350-40-HB	30535312

Características configurables



Forma del mango:
Forma del mango: HA | HE



Especificación
TTS100-18-DR1-4150-40-[forma del mango]

Ejemplo:

TTS100-18-DR1-4150-40-HE

Forma del mango HE

Portaherramientas para cabezal intercambiable TTS

Con sistema de amarre frontal para broca de cabezal intercambiable TTD TTS100 (3xD), con suministro de refrigerante interior

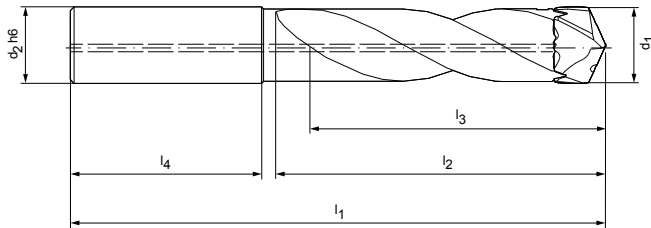

Ejecución:

Para diámetro de broca: 12,00 - 45,49 mm

Sistema de cambio: Sistema de amarre frontal
Posibilidad de realizar el cambio de cabezal en la máquina

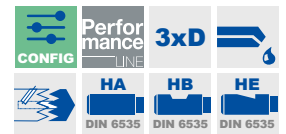

Serie preferente disponible en stock

Dimensiones							Forma del mango HB	
d ₁	Interfaz	d ₂ h6	l ₁	l ₂	l ₃	l ₄	Especificación	Referencia
12,00-12,49	TTS12-S	14	100	53	38	45	TTS100-12-DR3-1200-14-HB	30232785
12,50-12,99	TTS12-S	14	105	55	39	45	TTS100-12-DR3-1250-14-HB	30232787
13,00-13,49	TTS12-S	14	105	57	41	45	TTS100-12-DR3-1300-14-HB	30232789
13,50-13,99	TTS12-S	16	110	59	42	48	TTS100-12-DR3-1350-16-HB	30232790
14,00-14,49	TTS12-S	16	115	61	44	48	TTS100-12-DR3-1400-16-HB	30232792
14,50-14,99	TTS12-S	16	115	63	45	48	TTS100-12-DR3-1450-16-HB	30232793
15,00-15,49	TTS12-S	16	115	65	47	48	TTS100-12-DR3-1500-16-HB	30232794
15,50-16,49	TTS12-S	18	120	70	50	48	TTS100-12-DR3-1550-18-HB	30191496
16,50-17,49	TTS12-S	18	125	74	53	48	TTS100-12-DR3-1650-18-HB	30191497
17,50-18,49	TTS12-S	18	130	78	56	48	TTS100-12-DR3-1750-18-HB	30191498
18,50-19,49	TTS12-S	20	135	82	59	50	TTS100-12-DR3-1850-20-HB	30191499
19,50-20,49	TTS12-S	20	140	87	62	50	TTS100-12-DR3-1950-20-HB	30191500
20,50-21,49	TTS12-S	25	150	91	65	56	TTS100-12-DR3-2050-25-HB	30191501
21,50-22,49	TTS12-S	25	155	95	68	56	TTS100-12-DR3-2150-25-HB	30191502
22,50-23,49	TTS12-S	25	160	99	71	56	TTS100-12-DR3-2250-25-HB	30191503
23,50-24,49	TTS12-S	25	165	103	74	56	TTS100-12-DR3-2350-25-HB	30191504
24,50-25,49	TTS18-S	25	165	108	77	56	TTS100-18-DR3-2450-25-HB	30191505
25,50-26,49	TTS18-S	25	175	112	80	56	TTS100-18-DR3-2550-25-HB	30191507
26,50-27,49	TTS18-S	25	175	116	83	56	TTS100-18-DR3-2650-25-HB	30191508
27,50-28,49	TTS18-S	25	180	120	86	56	TTS100-18-DR3-2750-25-HB	30191509
28,50-29,49	TTS18-S	32	190	124	89	60	TTS100-18-DR3-2850-32-HB	30191510
29,50-30,49	TTS18-S	32	195	129	92	60	TTS100-18-DR3-2950-32-HB	30191511
30,50-31,49	TTS18-S	32	195	133	95	60	TTS100-18-DR3-3050-32-HB	30191512
31,50-32,49	TTS18-S	32	200	137	98	60	TTS100-18-DR3-3150-32-HB	30191513
32,50-33,49	TTS18-S	32	210	144	101	60	TTS100-18-DR3-3250-32-HB	30322289
33,50-34,49	TTS18-S	32	215	148	104	60	TTS100-18-DR3-3350-32-HB	30322290
34,50-35,49	TTS18-S	32	227	161	107	60	TTS100-18-DR3-3550-32-HB	30496706
34,50-35,49	TTS18-S	32	220	153	107	60	TTS100-18-DR3-3450-32-HB	30322291
35,50-37,49	TTS18-S	40	237	161	113	70	TTS100-18-DR3-3550-40-HB	30535313
37,50-39,49	TTS18-S	32	237	170	119	60	TTS100-18-DR3-3750-32-HB	30496707
37,50-39,49	TTS18-S	40	247	170	119	70	TTS100-18-DR3-3750-40-HB	30535316
39,50-41,49	TTS18-S	32	247	178	125	60	TTS100-18-DR3-3950-32-HB	30496708

Continúa en la página siguiente.

Portaherramientas para cabezal intercambiable TTS 100 (3xD), con suministro de refrigerante interior

Dimensiones							Forma del mango HB	
d ₁	Interfaz	d ₂ h6	l ₁	l ₂	l ₃	l ₄	Especificación	Referencia
39,50-41,49	TTS18-S	40	257	178	125	70	TTS100-18-DR3-3950-40-HB	30535318
41,50-43,49	TTS18-S	40	265	187	131	70	TTS100-18-DR3-4150-40-HB	30535320
43,50-45,49	TTS18-S	40	275	196	137	70	TTS100-18-DR3-4350-40-HB	30535321

Características configurables



Forma del mango:
Forma del mango: HA | HE



Especificación
TTS100-18-DR5-4150-40-[forma del mango]

Ejemplo:

TTS100-18-DR5-4150-40-HE

Forma del mango HE

Portaherramientas para cabezal intercambiable TTS

Con sistema de amarre frontal para broca de cabezal intercambiable TTD
TTS100 (5xD), con suministro de refrigerante interior

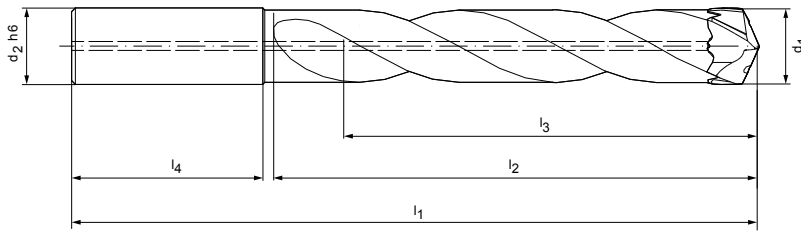

Ejecución:

Para diámetro de broca: 12,00 - 45,49 mm

Sistema de cambio: Sistema de amarre frontal
Posibilidad de realizar el cambio de cabezal en la máquina

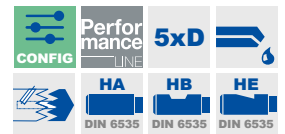

Serie preferente disponible en stock

Dimensiones							Forma del mango HB	
d ₁	Interfaz	d ₂ h6	l ₁	l ₂	l ₃	l ₄	Especificación	Referencia
12,00-12,49	TTS12-S	14	125	78	63	45	TTS100-12-DR5-1200-14-HB	30232796
12,50-12,99	TTS12-S	14	130	81	65	45	TTS100-12-DR5-1250-14-HB	30232798
13,00-13,49	TTS12-S	14	130	84	68	45	TTS100-12-DR5-1300-14-HB	30232799
13,50-13,99	TTS12-S	16	140	88	70	48	TTS100-12-DR5-1350-16-HB	30232800
14,00-14,49	TTS12-S	16	140	90	73	48	TTS100-12-DR5-1400-16-HB	30232801
14,50-14,99	TTS12-S	16	145	94	75	48	TTS100-12-DR5-1450-16-HB	30232802
15,00-15,49	TTS12-S	16	145	96	78	48	TTS100-12-DR5-1500-16-HB	30232803
15,50-16,49	TTS12-S	18	155	103	83	48	TTS100-12-DR5-1550-18-HB	30191514
16,50-17,49	TTS12-S	18	160	109	88	48	TTS100-12-DR5-1650-18-HB	30191515
17,50-18,49	TTS12-S	18	165	115	93	48	TTS100-12-DR5-1750-18-HB	30191516
18,50-19,49	TTS12-S	20	175	121	98	50	TTS100-12-DR5-1850-20-HB	30191517
19,50-20,49	TTS12-S	20	180	128	103	50	TTS100-12-DR5-1950-20-HB	30191518
20,50-21,49	TTS12-S	25	195	134	108	56	TTS100-12-DR5-2050-25-HB	30191519
21,50-22,49	TTS12-S	25	200	140	113	56	TTS100-12-DR5-2150-25-HB	30191520
22,50-23,49	TTS12-S	25	205	146	118	56	TTS100-12-DR5-2250-25-HB	30191521
23,50-24,49	TTS12-S	25	210	152	123	56	TTS100-12-DR5-2350-25-HB	30191522
24,50-25,49	TTS18-S	25	220	159	128	56	TTS100-18-DR5-2450-25-HB	30191523
25,50-26,49	TTS18-S	25	225	165	133	56	TTS100-18-DR5-2550-25-HB	30191525
26,50-27,49	TTS18-S	25	230	171	138	56	TTS100-18-DR5-2650-25-HB	30191526
27,50-28,49	TTS18-S	25	240	177	143	56	TTS100-18-DR5-2750-25-HB	30191527
28,50-29,49	TTS18-S	32	250	183	148	60	TTS100-18-DR5-2850-32-HB	30191528
29,50-30,49	TTS18-S	32	255	190	153	60	TTS100-18-DR5-2950-32-HB	30191529
30,50-31,49	TTS18-S	32	260	196	158	60	TTS100-18-DR5-3050-32-HB	30191530
31,50-32,49	TTS18-S	32	265	202	163	60	TTS100-18-DR5-3150-32-HB	30191531
32,50-33,49	TTS18-S	32	275	210	168	60	TTS100-18-DR5-3250-32-HB	30322313
33,50-34,49	TTS18-S	32	285	217	173	60	TTS100-18-DR5-3350-32-HB	30322314
34,50-35,49	TTS18-S	32	290	224	178	60	TTS100-18-DR5-3450-32-HB	30322315
35,50-37,49	TTS18-S	32	302	236	188	60	TTS100-18-DR5-3550-32-HB	30496709
*35,50-37,49	TTS18-S	40	312	236	188	70	TTS100-18-DR5-3550-40-HB	30535324
37,50-39,49	TTS18-S	32	317	249	198	60	TTS100-18-DR5-3750-32-HB	30496710
*37,50-39,49	TTS18-S	40	327	249	198	70	TTS100-18-DR5-3750-40-HB	30534860

Continúa en la página siguiente.

Portaherramientas para cabezal intercambiable TTS 100 (5xD), con suministro de refrigerante interior

Dimensiones							Forma del mango HB	
d ₁	Interfaz	d ₂ h6	l ₁	l ₂	l ₃	l ₄	Especificación	Referencia
39,50-41,49	TTS18-S	32	327	261	208	60	TTS100-18-DR5-3950-32-HB	30496711
*39,50-41,49	TTS18-S	40	337	261	208	70	TTS100-18-DR5-3950-40-HB	30535326
*41,50-43,49	TTS18-S	40	350	274	218	70	TTS100-18-DR5-4150-40-HB	30535327
*43,50-45,49	TTS18-S	40	365	287	228	70	TTS100-18-DR5-4350-40-HB	30535328

Características configurables



Forma del mango:
Forma del mango: HA | HE



Especificación
TTS100-18-DR5-4150-40-[forma del mango]

Ejemplo:

TTS100-18-DR5-4150-40-HE

Forma del mango HE

Portaherramientas para cabezal intercambiable TTS

Con sistema de amarre frontal para broca de cabezal intercambiable TTD
TTS100 (8xD), con suministro de refrigerante interior

Ejecución:

Para diámetro de broca: 12,00 - 45,49 mm

Sistema de cambio: Sistema de amarre frontal
Posibilidad de realizar el cambio de cabezal en la máquina

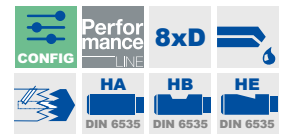
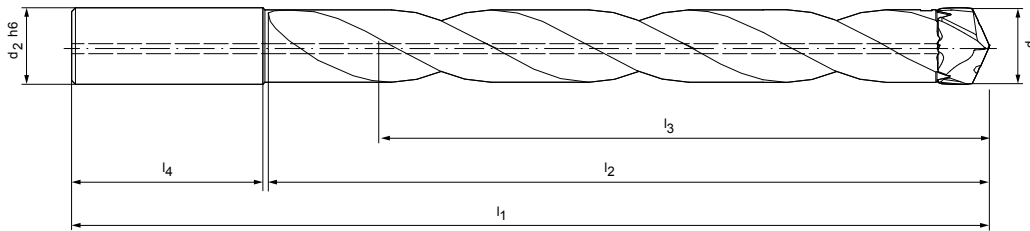

Serie preferente disponible en stock

Dimensiones							Forma del mango HB	
d ₁	Interfaz	d ₂ h6	l ₁	l ₂	l ₃	l ₄	Especificación	Referencia
12,00-12,49	TTS12-S	14	165	116	100	45	TTS100-12-DR8-1200-14-HB	30232805
12,50-12,99	TTS12-S	14	170	121	104	45	TTS100-12-DR8-1250-14-HB	30232806
13,00-13,49	TTS12-S	14	175	126	108	45	TTS100-12-DR8-1300-14-HB	30232807
13,50-13,99	TTS12-S	16	180	129	112	48	TTS100-12-DR8-1350-16-HB	30232808
14,00-14,49	TTS12-S	16	185	134	116	48	TTS100-12-DR8-1400-16-HB	30232809
14,50-14,99	TTS12-S	16	190	139	120	48	TTS100-12-DR8-1450-16-HB	30232810
15,00-15,49	TTS12-S	16	195	144	124	48	TTS100-12-DR8-1500-16-HB	30232811
15,50-16,49	TTS12-S	18	205	152	132	48	TTS100-12-DR8-1550-18-HB	30191532
16,50-17,49	TTS12-S	18	215	161	140	48	TTS100-12-DR8-1650-18-HB	30191533
17,50-18,49	TTS12-S	18	220	171	148	48	TTS100-12-DR8-1750-18-HB	30191534
18,50-19,49	TTS12-S	20	235	180	156	50	TTS100-12-DR8-1850-20-HB	30191535
19,50-20,49	TTS12-S	20	240	189	164	50	TTS100-12-DR8-1950-20-HB	30191536
20,50-21,49	TTS12-S	25	260	198	172	56	TTS100-12-DR8-2050-25-HB	30191537
21,50-22,49	TTS12-S	25	270	207	180	56	TTS100-12-DR8-2150-25-HB	30191538
22,50-23,49	TTS12-S	25	275	217	188	56	TTS100-12-DR8-2250-25-HB	30191539
23,50-24,49	TTS12-S	25	285	226	196	56	TTS100-12-DR8-2350-25-HB	30191540
24,50-25,49	TTS18-S	25	295	235	204	56	TTS100-18-DR8-2450-25-HB	30191541
25,50-26,49	TTS18-S	25	305	244	212	56	TTS100-18-DR8-2550-25-HB	30191543
26,50-27,49	TTS18-S	25	315	253	220	56	TTS100-18-DR8-2650-25-HB	30191544
27,50-28,49	TTS18-S	25	325	263	228	56	TTS100-18-DR8-2750-25-HB	30191545
28,50-29,49	TTS18-S	32	340	272	236	60	TTS100-18-DR8-2850-32-HB	30191546
29,50-30,49	TTS18-S	32	345	281	244	60	TTS100-18-DR8-2950-32-HB	30191547
30,50-31,49	TTS18-S	32	355	290	252	60	TTS100-18-DR8-3050-32-HB	30191548
31,50-32,49	TTS18-S	32	360	299	260	60	TTS100-18-DR8-3150-32-HB	30191549
32,50 - 33,49	TTS18-S	32	375	275	268	60	TTS100-18-DR8-3250-32-HB	30809129
33,50 - 34,49	TTS18-S	32	385	317	276	60	TTS100-18-DR8-3350-32-HB	30809654
34,50 - 35,49	TTS18-S	32	395	329	284	60	TTS100-18-DR8-3450-32-HB	30809664
35,50 - 37,49	TTS18-S	32	402	336	300	60	TTS100-18-DR8-3550-32-HB	30812380
35,50 - 37,49	TTS18-S	40	412	336	300	70	TTS100-18-DR8-3550-40-HB	30809673

Continúa en la página siguiente.

Portaherramientas para cabezal intercambiable TTS 100 (8xD), suministro de refrigerante interior

Dimensiones							Forma del mango HB	
d ₁	Interfaz	d ₂ h6	l ₁	l ₂	l ₃	l ₄	Especificación	Referencia
37,50 - 39,49	TTS18-S	32	421	353	316	60	TTS100-18-DR8-3750-32-HB	30812379
37,50 - 39,49	TTS18-S	40	431	353	316	70	TTS100-18-DR8-3750-40-HB	30809961
39,50 - 41,49	TTS18-S	32	440	374	332	70	TTS100-18-DR8-3950-32-HB	30812376
39,50 - 41,49	TTS18-S	40	450	374	332	70	TTS100-18-DR8-3950-40-HB	30809964
41,50 - 43,49	TTS18-S	40	470	394	348	70	TTS100-18-DR8-4150-40-HB	30809976
43,50 - 45,49	TTS18-S	40	500	422	364	70	TTS100-18-DR8-4350-40-HB	30809158

Características configurables



Forma del mango:
Forma del mango: HA | HE



Especificación
TTS100-18-DR8-4150-40-[forma del mango]

Ejemplo:

TTS100-18-DR8-4150-40-HE

Forma del mango HE

Portaherramientas para cabezal intercambiable TTS

Con sistema de amarre frontal para broca de cabezal intercambiable TTD
TTS100 (12xD), con suministro de refrigerante interior

Ejecución:

Para diámetro de broca: 12,00 - 32,49 mm

Sistema de cambio: Sistema de amarre frontal
Posibilidad de realizar el cambio de cabezal en la máquina

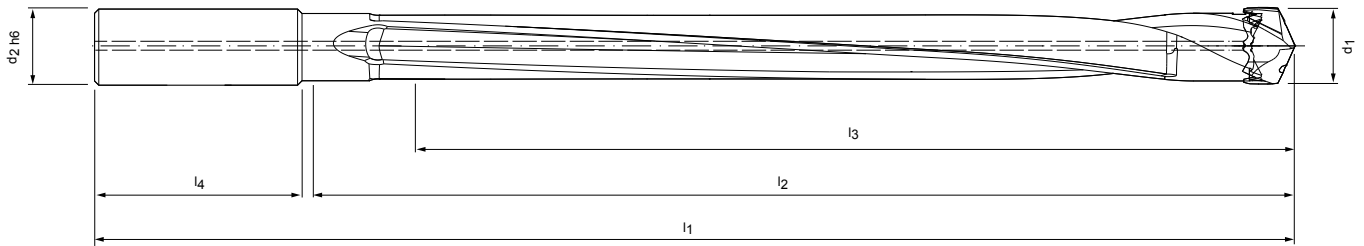

Serie preferente disponible en stock

Dimensiones							Forma del mango HB	
d ₁	Interfaz	d ₂ h6	l ₁	l ₂	l ₃	l ₄	Especificación	Referencia
12,00-12,49	TTS12-S	14	210	162	150	45	TTS100-12-DR12-1200-14-HB	30327798
12,50-12,99	TTS12-S	14	216	168	156	45	TTS100-12-DR12-1250-14-HB	30327802
13,00-13,49	TTS12-S	14	223	175	162	45	TTS100-12-DR12-1300-14-HB	30327805
13,50-13,99	TTS12-S	16	235	182	168	48	TTS100-12-DR12-1350-16-HB	30327808
14,00-14,49	TTS12-S	16	242	189	174	48	TTS100-12-DR12-1400-16-HB	30327811
14,50-14,99	TTS12-S	16	248	195	180	48	TTS100-12-DR12-1450-16-HB	30327814
15,00-15,49	TTS12-S	16	255	202	186	48	TTS100-12-DR12-1500-16-HB	30327817
15,50-16,49	TTS12-S	18	262	209	198	48	TTS100-12-DR12-1550-18-HB	30327820
16,50-17,49	TTS12-S	18	275	222	210	48	TTS100-12-DR12-1650-18-HB	30327824
17,50-18,49	TTS12-S	18	289	236	222	48	TTS100-12-DR12-1750-18-HB	30327828
18,50-19,49	TTS12-S	20	304	249	234	50	TTS100-12-DR12-1850-20-HB	30327833
19,50-20,49	TTS12-S	20	318	263	246	50	TTS100-12-DR12-1950-20-HB	30255588
20,50-21,49	TTS12-S	25	337	276	258	56	TTS100-12-DR12-2050-25-HB	30327844
21,50-22,49	TTS12-S	25	351	290	270	56	TTS100-12-DR12-2150-25-HB	30327847
22,50-23,49	TTS12-S	25	364	303	282	56	TTS100-12-DR12-2250-25-HB	30327851
23,50-24,49	TTS12-S	25	378	317	294	56	TTS100-12-DR12-2350-25-HB	30327854
24,50-25,49	TTS18-S	25	391	330	306	56	TTS100-18-DR12-2450-25-HB	30327859
25,50-26,49	TTS18-S	25	405	344	318	56	TTS100-18-DR12-2550-25-HB	30327863
26,50-27,49	TTS18-S	25	418	357	330	56	TTS100-18-DR12-2650-25-HB	30327866
27,50-28,49	TTS18-S	25	432	371	342	56	TTS100-18-DR12-2750-25-HB	30327870
28,50-29,49	TTS18-S	32	449	384	354	60	TTS100-18-DR12-2850-32-HB	30327873
29,50-30,49	TTS18-S	32	463	398	366	60	TTS100-18-DR12-2950-32-HB	30327876
30,50-31,49	TTS18-S	32	476	411	378	60	TTS100-18-DR12-3050-32-HB	30327879
31,50-32,49	TTS18-S	32	490	425	390	60	TTS100-18-DR12-3150-32-HB	30327883

Características configurables



Forma del mango:
Forma del mango: HA | HE



Especificación

TTS100-18-DR12-2850-32-[forma del mango]

Ejemplo:

TTS100-18-DR12-2850-32-HE

Forma del mango HE

Medidas en mm.

Observe la información de manipulación para la broca de cabezal intercambiable TTD (12xD) en la página 748. Ejecuciones especiales a petición.

Refacciones

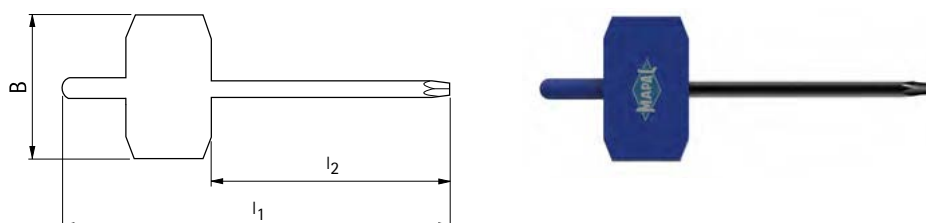

Destornillador hexagonal

Tipo de soporte	Ancho de llave	l_1	l_2	B	Referencia
TS100-12-DRx-1200-14-HB	1,3	95	60	38	10004355
TS100-12-DRx-1250-14-HB	1,3	95	60	38	10004355
TS100-12-DRx-1300-14-HB	1,3	95	60	38	10004355
TS100-12-DRx-1350-16-HB	1,5	95	60	38	10098108
TS100-12-DRx-1400-16-HB	1,5	95	60	38	10098108
TS100-12-DRx-1450-16-HB	1,5	95	60	38	10098108
TS100-12-DRx-1500-16-HB	1,5	95	60	38	10098108
TS100-12-DRx-1550-18-HB	1,5	95	60	38	10098108
TS100-12-DRx-1650-18-HB	2	95	60	38	10098109
TS100-12-DRx-1750-18-HB	2	95	60	38	10098109
TS100-12-DRx-1850-20-HB	2	95	60	38	10098109
TS100-12-DRx-1950-20-HB	2	95	60	38	10098109
TS100-12-DRx-2050-25-HB	2	95	60	38	10098109
TS100-12-DRx-2150-25-HB	2	95	60	38	10098109
TS100-12-DRx-2250-25-HB	2	95	60	38	10098109
TS100-12-DRx-2350-25-HB	2	95	60	38	10098109
TS100-18-DRx-2450-25-HB	2,5	95	60	38	10098110
TS100-18-DRx-2550-25-HB	2,5	95	60	38	10098110
TS100-18-DRx-2650-25-HB	2,5	95	60	38	10098110
TS100-18-DRx-2750-25-HB	2,5	95	60	38	10098110
TS100-18-DRx-2850-32-HB	2,5	95	60	38	10098110
TS100-18-DRx-2950-32-HB	2,5	95	60	38	10098110
TS100-18-DRx-3050-32-HB	2,5	95	60	38	10098110
TS100-18-DRx-3150-32-HB	2,5	95	60	38	10098110
TS100-18-DRx-3250-32-HB	3	100	60	38	10006234
TS100-18-DRx-3350-32-HB	3	100	60	38	10006234
TS100-18-DRx-3450-32-HB	3	100	60	38	10006234
TS100-18-DRx-3550-40-HB	3	100	60	38	10006234
TS100-18-DRx-3750-40-HB	3	100	60	38	10006234
TS100-18-DRx-3950-40-HB	3	100	60	38	10006234
TS100-18-DRx-4150-40-HB	4	100	60	38	10006235
TS100-18-DRx-4350-40-HB	4	100	60	38	10006235

Tornillo prisionero con revestimiento especial

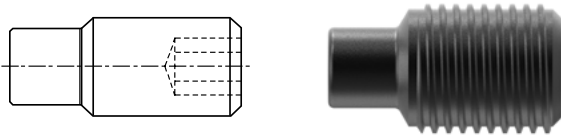

Tipo de soporte	Tornillo prisionero	Par de apriete [Nm]	Referencia
TS100-12-DRx-1200-14-HB	M2,5x5	1,0	30259117
TS100-12-DRx-1250-14-HB	M2,5x6	1,0	30259118
TS100-12-DRx-1300-14-HB	M2,5x6	1,0	30259118
TS100-12-DRx-1350-16-HB	M3x6	1,3	30259119
TS100-12-DRx-1400-16-HB	M3x6	1,3	30259119
TS100-12-DRx-1450-16-HB	M3x7	1,3	30193231
TS100-12-DRx-1500-16-HB	M3x7	1,3	30193231
TS100-12-DRx-1550-18-HB	M3x7	1,3	30193231
TS100-12-DRx-1650-18-HB	M4x0,5x7,5	3,5	30193232
TS100-12-DRx-1750-18-HB	M4x0,5x7,5	3,5	30193232
TS100-12-DRx-1850-20-HB	M4x0,5x7,5	3,5	30193232
TS100-12-DRx-1950-20-HB	M4x0,5x7,5	3,5	30193232
TS100-12-DRx-2050-25-HB	M4x0,5x10	3,5	30193233
TS100-12-DRx-2150-25-HB	M4x0,5x10	3,5	30193233
TS100-12-DRx-2250-25-HB	M4x0,5x10	3,5	30193233
TS100-12-DRx-2350-25-HB	M4x0,5x10	3,5	30193233
TS100-18-DRx-2450-25-HB	M5x0,5x11	4,0	30193234
TS100-18-DRx-2550-25-HB	M5x0,5x11	4,0	30193234
TS100-18-DRx-2650-25-HB	M5x0,5x11	4,0	30193234
TS100-18-DRx-2750-25-HB	M5x0,5x11	4,0	30193234
TS100-18-DRx-2850-32-HB	M5x0,5x14	4,0	30193235
TS100-18-DRx-2950-32-HB	M5x0,5x14	4,0	30193235
TS100-18-DRx-3050-32-HB	M5x0,5x14	4,0	30193235
TS100-18-DRx-3150-32-HB	M5x0,5x14	4,0	30193235
TS100-18-DRx-3250-32-HB	M6x0,5x16	6,0	30320812
TS100-18-DRx-3350-32-HB	M6x0,5x16	6,0	30320812
TS100-18-DRx-3450-32-HB	M6x0,5x16	6,0	30320812
TS100-18-DRx-3550-40-HB	M6x0,5x18	6,0	30320811
TS100-18-DRx-3750-40-HB	M6x0,5x18	6,0	30320811
TS100-18-DRx-3950-40-HB	M6x0,5x20	6,0	30320810
TS100-18-DRx-4150-40-HB	M8x1x20	10,0	30320806
TS100-18-DRx-4350-40-HB	M8x1x20	10,0	30320806

Recomendación de valores de corte para brocas de cabezal intercambiable TTD

Avance y velocidad de corte

Tipo 01 – Uni-Plus

Grupo de arranque de virutas de Mapal*	Material	Rigidez/dureza [N/mm ²] [HRC]
P	P1.1 Aceros de construcción, para tornos automáticos, de cementación y revenidos, no aleados	< 700
	P1.2 Aceros de construcción, para tornos automáticos, de cementación y revenidos, no aleados	< 1200
	P2.1 Aceros nitrurados, de cementación y aceros revenidos, aleados	< 900
	P2.2 Aceros nitrurados, de cementación y aceros revenidos, aleados	< 1400
	P3.1 Aceros para herramientas, rodamientos, resortes y rápidos**	< 800
	P3.2 Aceros para herramientas, rodamientos, resortes y rápidos**	< 1000
	P3.3 Aceros para herramientas, rodamientos, resortes y rápidos**	< 1500
	P5.1 Fundición de acero	
K	K1.1 Hierro fundido con grafito laminar (fundición gris), GJL	< 300
	K2.1 Hierro fundido con grafito esferoidal, GJS	< 500
	K2.2 Hierro fundido con grafito esferoidal, GJS	≤ 800
	K2.3 Hierro fundido con grafito esferoidal, GJS	> 800
	K3.1 Hierro fundido con grafito vermicular, GJV; fundición maleable, GJM	< 500
	K3.2 Hierro fundido con grafito vermicular, GJV; fundición maleable, GJM	> 500

Tipo 04 – Steel

Grupo de arranque de virutas de Mapal*	Material	Rigidez/dureza [N/mm ²] [HRC]
P	P1.1 Aceros de construcción, para tornos automáticos, de cementación y revenidos, no aleados	< 700
	P1.2 Aceros de construcción, para tornos automáticos, de cementación y revenidos, no aleados	< 1200
	P2.1 Aceros nitrurados, de cementación y aceros revenidos, aleados	< 900
	P2.2 Aceros nitrurados, de cementación y aceros revenidos, aleados	< 1400
	P3.1 Aceros para herramientas, rodamientos, resortes y rápidos**	< 800
	P3.2 Aceros para herramientas, rodamientos, resortes y rápidos**	< 1000
	P3.3 Aceros para herramientas, rodamientos, resortes y rápidos**	< 1500
	P4.1 Aceros inoxidables, ferríticos y martensíticos	
	P5.1 Fundición de acero	
	P6.1 Fundición de acero inoxidable, ferrítica y martensítica	
K	K1.1 Hierro fundido con grafito laminar (fundición gris), GJL	< 300
	K2.1 Hierro fundido con grafito esferoidal, GJS	< 500
	K2.2 Hierro fundido con grafito esferoidal, GJS	≤ 800
	K2.3 Hierro fundido con grafito esferoidal, GJS	> 800
	K3.1 Hierro fundido con grafito vermicular, GJV; fundición maleable, GJM	< 500
	K3.2 Hierro fundido con grafito vermicular, GJV; fundición maleable, GJM	> 500

Tipo 03 – Alu

Grupo de arranque de virutas de Mapal*	Material	Rigidez/dureza [N/mm ²] [HRC]
N1	N1.1 Aluminio, aleado y no aleado < 3 % Si	
	N1.2 Aluminio, aleado ≤ 7 % Si	
	N1.3 Aluminio, aleado > 7-12 % Si	
	N1.4 Aluminio, aleado > 12 % Si	
N2	N2.1 Cobre, no aleado y de baja aleación	< 300
	N2.2 Cobre, aleado	> 300
	N2.3 Latón, bronce, fundición roja	< 1200

* Grupos de mecanizado MAPAL

** Si los componentes de aleación de Cr, Mo, Ni, V, W suman > 8 %, elegir el siguiente grupo de mecanizado MAPAL superior.

	Velocidad de corte v_c [m/min]				Avance f [mm] con diámetro de broca					
	Refrigeración interna	Refrigeración exterior	MMS	Aire	12,00	15,50	19,50	25,00	32,00	40,00
	110	100	100		0,23	0,26	0,29	0,32	0,33	0,33
	100	85	85		0,29	0,33	0,37	0,40	0,41	0,41
	110	95	95		0,27	0,31	0,35	0,37	0,39	0,39
	75	65	65		0,22	0,25	0,27	0,30	0,31	0,31
	85	70	70		0,24	0,28	0,31	0,34	0,35	0,35
	65	60	60		0,20	0,23	0,25	0,27	0,28	0,29
	65	50	55		0,16	0,18	0,20	0,21	0,22	0,22
	110	95	95		0,27	0,31	0,35	0,37	0,39	0,39
	110	75	75	75	0,34	0,39	0,44	0,48	0,49	0,49
	145	90	110	110	0,31	0,36	0,40	0,44	0,45	0,46
	90	70	70		0,27	0,31	0,35	0,38	0,39	0,39
	55	35	45		0,18	0,21	0,23	0,25	0,26	0,26
	80	70	70		0,29	0,34	0,37	0,40	0,42	0,42
	70	65	65		0,23	0,27	0,30	0,32	0,33	0,33

	Velocidad de corte v_c [m/min]				Avance f [mm] con diámetro de broca					
	Refrigeración interna	Refrigeración exterior	MMS	Aire	12,00	15,50	19,50	25,00	32,00	40,00
	110	100	100		0,26	0,30	0,34	0,36	0,38	0,38
	100	85	85		0,33	0,38	0,42	0,46	0,47	0,47
	110	95	95		0,31	0,36	0,40	0,43	0,45	0,45
	75	65	65		0,25	0,28	0,31	0,34	0,35	0,35
	85	70	70		0,28	0,32	0,36	0,39	0,40	0,41
	65	60	60		0,23	0,26	0,29	0,32	0,33	0,33
	65	50	55		0,18	0,20	0,23	0,24	0,25	0,25
	65	50	55		0,18	0,21	0,24	0,25	0,26	0,27
	110	95	95		0,31	0,36	0,40	0,43	0,45	0,45
	65	50	55		0,18	0,21	0,24	0,25	0,26	0,27
	110	75	75	75	0,37	0,44	0,49	0,53	0,55	0,55
	145	90	110	110	0,35	0,40	0,45	0,49	0,50	0,51
	90	70	70		0,30	0,35	0,39	0,42	0,43	0,43
	55	35	45		0,20	0,23	0,25	0,27	0,28	0,29
	80	70	70		0,32	0,37	0,41	0,45	0,47	0,47
	70	65	65		0,26	0,30	0,33	0,35	0,37	0,37

	Velocidad de corte v_c [m/min]				Avance f [mm] con diámetro de broca					
	Refrigeración interna	Refrigeración exterior	MMS	Aire	12,00	15,50	19,50	25,00	32,00	40,00
	300	200	250		0,23	0,26	0,29	0,32	0,33	0,33
	250	180	200		0,30	0,35	0,39	0,42	0,43	0,43
	220	150	180		0,30	0,35	0,39	0,42	0,43	0,43
	180	120	150		0,30	0,35	0,39	0,42	0,43	0,43
	140	100			0,23	0,26	0,29	0,32	0,33	0,33
	120	90			0,30	0,35	0,39	0,42	0,43	0,43
	200	160	160	120	0,37	0,44	0,49	0,53	0,55	0,55

Los valores de corte indicados son de referencia.

Los datos óptimos para cada situación de mecanizado deben determinarse mediante ensayos o durante el propio proceso de mecanizado.

Recomendación de valores de corte para brocas de cabezal intercambiable TTD

Avance y velocidad de corte

Tipo 02 – Inox

Grupo de arranque de virutas de Mapal*	Material	Rigidez/dureza [N/mm ²] [HRC]
P	P1.1 Aceros de construcción, para tornos automáticos, de cementación y revenidos, no aleados	< 700
	P1.2 Aceros de construcción, para tornos automáticos, de cementación y revenidos, no aleados	< 1200
	P2.1 Aceros nitrurados, de cementación y aceros revenidos, aleados	< 900
	P2.2 Aceros nitrurados, de cementación y aceros revenidos, aleados	< 1400
	P3.1 Aceros para herramientas, rodamientos, resortes y rápidos**	< 800
	P3.2 Aceros para herramientas, rodamientos, resortes y rápidos**	< 1000
	P3.3 Aceros para herramientas, rodamientos, resortes y rápidos**	< 1500
	P4.1 Aceros inoxidables, ferríticos y martensíticos	
	P5.1 Fundición de acero	
	P6.1 Fundición de acero inoxidable, ferrítica y martensítica	
M	M1.1 Aceros inoxidables, austeníticos	< 700
	M1.2 Aceros inoxidables, ferríticos/austeníticos (dúplex)	< 1000
	M2.1 Fundición de acero inoxidable, austenítica	< 700
	M3.1 Fundición de acero inoxidable, ferrítica/austenítica (dúplex)	< 1000
K	K1.1 Hierro fundido con grafito laminar (fundición gris), GJL	< 300
	K2.1 Hierro fundido con grafito esferoidal, GJS	< 500
	K2.2 Hierro fundido con grafito esferoidal, GJS	≤ 800
	K2.3 Hierro fundido con grafito esferoidal, GJS	> 800
	K3.1 Hierro fundido con grafito vermicular, GJV; fundición maleable, GJM	< 500
	K3.2 Hierro fundido con grafito vermicular, GJV; fundición maleable, GJM	> 500
N2	N2.1 Cobre, no aleado y de baja aleación	< 300
	N2.2 Cobre, aleado	> 300
	N2.3 Latón, bronce, fundición roja	< 1200
S	S1.1 Titanio, aleaciones de titanio	< 400
	S2.1 Titanio, aleaciones de titanio	< 1200
	S2.2 Titanio, aleaciones de titanio	> 1200
	S3.1 Níquel, no aleado y aleado	< 900
	S3.2 Níquel, no aleado y aleado	> 900
	S4.1 Superaleación de gran resistencia al calor basada en Ni, Co y Fe	
	S5.1 Aleaciones de wolframio y molibdeno	

Tipo 05 – Iron

Grupo de arranque de virutas de Mapal*	Material	Rigidez/dureza [N/mm ²] [HRC]
K	K1.1 Hierro fundido con grafito laminar (fundición gris), GJL	< 300
	K2.1 Hierro fundido con grafito esferoidal, GJS	< 500
	K2.2 Hierro fundido con grafito esferoidal, GJS	≤ 800
	K2.3 Hierro fundido con grafito esferoidal, GJS	> 800
	K3.1 Hierro fundido con grafito vermicular, GJV; fundición maleable, GJM	< 500
	K3.2 Hierro fundido con grafito vermicular, GJV; fundición maleable, GJM	> 500

* Grupos de mecanizado MAPAL

** Si los componentes de aleación de Cr, Mo, Ni, V, W suman > 8 %, elegir el siguiente grupo de mecanizado MAPAL superior.

	Velocidad de corte v_c [m/min]				Avance f [mm] con diámetro de broca					
	Refrigeración interna	Refrigeración exterior	MMS	Aire	12,00	15,50	19,50	25,00	32,00	40,00
	100	90	90		0,21	0,24	0,26	0,28	0,30	0,30
	90	75	75		0,26	0,30	0,33	0,36	0,37	0,37
	100	85	85		0,24	0,28	0,31	0,34	0,35	0,35
	70	60	60		0,19	0,22	0,25	0,27	0,28	0,28
	75	65	65		0,22	0,25	0,28	0,30	0,32	0,32
	60	55	55		0,18	0,21	0,23	0,25	0,26	0,26
	60	45	50		0,14	0,16	0,18	0,19	0,20	0,20
	60	45	50		0,14	0,17	0,18	0,20	0,21	0,21
	100	85	85		0,24	0,28	0,31	0,34	0,35	0,35
	60	45	50		0,14	0,17	0,18	0,20	0,21	0,21
	55	35	35		0,18	0,21	0,24	0,25	0,26	0,27
	50	30	30		0,16	0,18	0,20	0,22	0,23	0,23
	55	35	35		0,18	0,21	0,24	0,25	0,26	0,27
	50	30	30		0,16	0,18	0,20	0,22	0,23	0,23
	95	70	70	70	0,34	0,39	0,44	0,48	0,49	0,49
	130	80	95	95	0,31	0,36	0,40	0,44	0,45	0,46
	80	60	60		0,27	0,31	0,35	0,38	0,39	0,39
	50	30	40		0,18	0,21	0,23	0,25	0,26	0,26
	70	65	65		0,29	0,34	0,37	0,40	0,42	0,42
	65	55	55		0,23	0,27	0,30	0,32	0,33	0,33
	140	100			0,23	0,26	0,29	0,32	0,33	0,33
	120	90			0,30	0,35	0,39	0,42	0,43	0,43
	200	160	160	120	0,37	0,44	0,49	0,53	0,55	0,55
	40	25			0,16	0,18	0,21	0,22	0,23	0,23
	30	20			0,14	0,16	0,18	0,19	0,20	0,20
	25	15			0,11	0,13	0,15	0,16	0,16	0,17
	20	15			0,09	0,11	0,12	0,13	0,13	0,13
	15	10			0,11	0,13	0,15	0,16	0,16	0,17
	15	10			0,09	0,11	0,12	0,13	0,13	0,13
	15	10			0,09	0,11	0,12	0,13	0,13	0,13

	Velocidad de corte v_c [m/min]				Avance f [mm] con diámetro de broca					
	Refrigeración interna	Refrigeración exterior	MMS	Aire	12,00	15,50	19,50	25,00	32,00	40,00
	120	85	85	85	0,45	0,52	0,58	0,63	0,66	0,66
	160	100	120	120	0,42	0,48	0,54	0,58	0,60	0,61
	100	75	75		0,36	0,42	0,46	0,50	0,52	0,52
	60	40	50		0,24	0,28	0,30	0,33	0,34	0,34
	90	80	80		0,39	0,45	0,50	0,54	0,56	0,56
	80	70	70		0,31	0,36	0,39	0,43	0,44	0,44

Los valores de corte indicados son de referencia.

Los datos óptimos para cada situación de mecanizado deben determinarse mediante ensayos o durante el propio proceso de mecanizado.

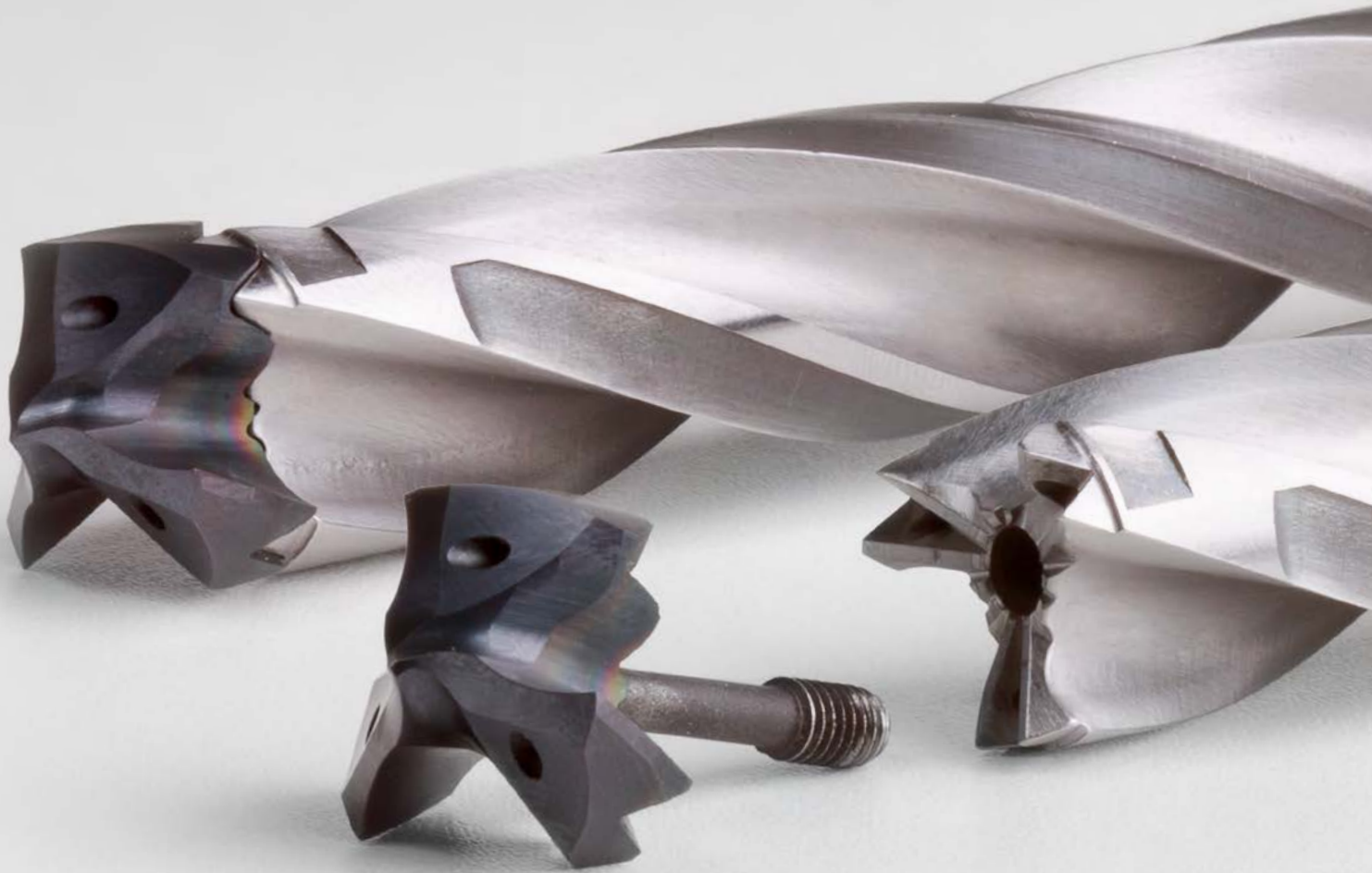

BROCA DE CABEZAL INTERCAMBIABLE TTD-TRITAN

Uso minimizado de metal duro con la máxima estabilidad y precisión

La Tritan-Drill de tres filos también está disponible como variante de cabezal intercambiable.

El cabezal de la herramienta y el portaherramientas están unidos por medio de un dentado Hirth. Esta unión es especialmente estable, por lo que con la variante de cabezal intercambiable se mantienen todas las ventajas y el nivel de rendimiento del modelo equivalente de metal duro macizo. La estabilidad de la unión se debe, entre otras cosas, a los tres filos, ideal para un sistema de cabezal intercambiable.

Gracias a los tres insertos, la carga de la unión es homogénea, es decir, las fuerzas que se generan en el mecanizado se transmiten uniformemente al portaherramientas de acero. Además, la unión garantiza una transmisión óptima del par y, al mismo tiempo, una elevada precisión de cambio y de concentricidad.

En comparación con las brocas de cabezal intercambiable de doble filo de metal duro, la TTD-Tritan permite efectuar avances con el doble de longitud.

Como resultado, el taladrado se efectúa con estabilidad y seguridad de proceso incluso en situaciones difíciles, como cuando la entrada está inclinada o en presencia de agujeros transversales. La herramienta se centra óptimamente por medio de su marcada punta de taladrado y proporciona muy buena circularidad. Y esto por un precio inferior al de las brocas fabricadas por completo en metal duro. Con el nuevo sistema de cabezal intercambiable, el costoso metal duro se utiliza únicamente en la herramienta. Esto garantiza costes inferiores también con grandes diámetros.

Características detalladas de la herramienta

Mango cilíndrico con plano de sujeción que garantiza una sujeción segura y una transmisión de fuerza óptima

Tres ranuras de alojamiento de virutas para un transporte óptimo de virutas

Broca de cabezal intercambiable de tres filos

Portaherramientas de material templado de alta calidad

Alcance del programa: todas las longitudes disponibles

Dentado Hirth con protección a prueba de error

Punta innovadora

Cuchilla transversal con autocentrado

RESUMEN
- Broca de cabezal intercambiable de tres filos
- Rango de \varnothing de 12,00 a 32,49 mm
- Profundidades de taladrado 3 5 y 8xD
- Con refrigeración interna
- Manejo sencillo
- Posibilidad de realizar el cambio de cabezal en la máquina

CARACTERÍSTICAS DE RENDIMIENTO
- Hasta el doble de avance en comparación con brocas de cabezal intercambiable de doble filo
- Elevada precisión de cambio y concentricidad
- Herramienta óptima para la entrada inclinada en agujeros
- La herramienta se centra a través de la marcada punta de la broca
- Alta transmisión del par

VENTAJAS
- Incremento significativo de la velocidad de avance y de la vida útil
- Geometría Tritan para unos excelentes resultados de taladrado
- Alta seguridad en el proceso y estabilidad también en situaciones de taladrado difíciles
- Carga homogénea de la unión mediante tres insertos

Cabezal de taladrado intercambiable TTD-Tritan

De metal duro, suministro de refrigerante interior
Tipo 01 – Uni

Ejecución:

Diámetro de broca: 12,00 – 32,49 mm
Tolerancia del agujero: IT 9 (alcanzable)
Material de corte: HP926
Número de insertos: 3
Número de bisel guía: 3
Ángulo de la punta: 140°

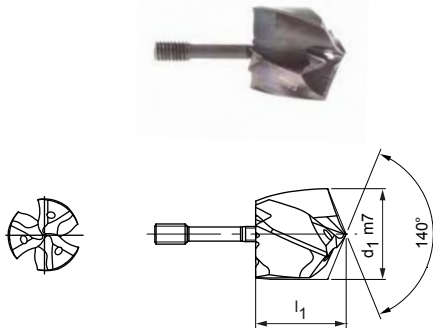

Serie preferente disponible en stock

d ₁ de 13,50 a 20,00		
d ₁ m7	Especificación	Referencia
13,50	TTD300-3F01-1350-HP926	30871173
14,00	TTD300-3F01-1400-HP926	30871178
14,40	TTD300-3F01-1440-HP926	30871182
14,60	TTD300-3F01-1460-HP926	30871184
15,00	TTD300-3F01-1500-HP926	30871188
15,10	TTD300-3F01-1510-HP926	30871189
15,20	TTD300-3F01-1520-HP926	30871190
15,38	TTD300-3F01-1538-HP926	31290822
15,40	TTD300-3F01-1540-HP926	30871192
16,00	TTD300-3F01-1600-HP926	30871198
16,50	TTD300-3F01-1650-HP926	30871203
17,00	TTD300-3F01-1700-HP926	30871209
17,50	TTD300-3F01-1750-HP926	30871214
18,00	TTD300-3F01-1800-HP926	30871219
18,50	TTD300-3F01-1850-HP926	30871224
19,00	TTD300-3F01-1900-HP926	30871229
19,80	TTD300-3F01-1980-HP926	30871237
20,00	TTD300-3F01-2000-HP926	30871239

d ₁ de 20,50 a 32,00		
d ₁ m7	Especificación	Referencia
20,50	TTD300-3F01-2050-HP926	30871244
21,00	TTD300-3F01-2100-HP926	30871249
22,00	TTD300-3F01-2200-HP926	30871259
24,00	TTD300-3F01-2400-HP926	30871279
24,70	TTD300-3F01-2470-HP926	30871287
25,00	TTD300-3F01-2500-HP926	30871290
25,10	TTD300-3F01-2510-HP926	30871291
25,20	TTD300-3F01-2520-HP926	30871292
26,00	TTD300-3F01-2600-HP926	30871300
26,10	TTD300-3F01-2610-HP926	30871301
26,50	TTD300-3F01-2650-HP926	30871305
27,00	TTD300-3F01-2700-HP926	30871310
27,10	TTD300-3F01-2710-HP926	30871311
28,00	TTD300-3F01-2800-HP926	30871320
28,50	TTD300-3F01-2850-HP926	30871325
31,00	TTD300-3F01-3100-HP926	30871350
32,00	TTD300-3F01-3200-HP926	30871360

Características configurables



Diámetro:
Diámetro seleccionable libremente en incrementos de 0,01 mm

Especificación
TTD300-3F01-[diámetro]-HP929

Dimensiones de la serie configurable

d ₁ min.	d ₁ máx.
12,00	32,49

Ejemplo:

TTD300-4F03-1401-HP619

Diámetro de la herramienta d₁ = 14,01 mm

Medidas en mm.

Para la recomendación de valores de corte, véase al final del capítulo.
Ejecuciones especiales y otros recubrimientos a petición.

Portaherramientas para cabezal intercambiable TTS

TTS300 con sistema de sujeción axial para broca de cabezal intercambiable TTD-Tritan (3xD), con suministro de refrigerante interior

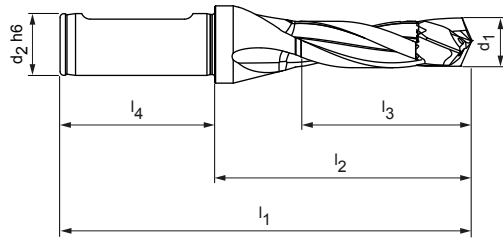

Ejecución:

Diámetro de broca:

12,00 – 32,49 mm

Sistema de cambio:

Sujeción central a través del orificio de refrigerante

Observación:

Llave de montaje incluida en el volumen de suministro.



Serie preferente disponible en stock

Dimensiones						Forma del mango HB	
d ₁	d ₂ h6	l ₁	l ₂	l ₃	l ₄	Especificación	Referencia
14,00 - 14,49	16	120	72	48	48	TTS300B-1400-DR3-ZYL-16-MN	30839684
14,50 - 14,99	16	122	74	49	48	TTS300B-1450-DR3-ZYL-16-MN	30839685
15,00 - 15,49	16	124	76	51	48	TTS300B-1500-DR3-ZYL-16-MN	30839686
17,50 - 18,49	20	140	90	61	50	TTS300B-1750-DR3-ZYL-20-MN	30839689
18,50 - 19,49	25	150	94	64	56	TTS300B-1850-DR3-ZYL-25-MN	30839690
20,50 - 21,49	25	159	103	71	56	TTS300B-2050-DR3-ZYL-25-MN	30839692
21,50 - 22,49	25	164	108	74	56	TTS300B-2150-DR3-ZYL-25-MN	30839693
24,50 - 25,49	32	182	122	84	60	TTS300B-2450-DR3-ZYL-32-MN	30839696
26,50 - 27,49	32	191	131	91	60	TTS300B-2650-DR3-ZYL-32-MN	30839698

Disponibles a petición

Dimensiones						Forma del mango HB	
d ₁	d ₂ h6	l ₁	l ₂	l ₃	l ₄	Especificación	Referencia
12,00 - 12,49	16	111	63	39	48	TTS300B-1200-DR3-ZYL-16-MN	30839680
12,50 - 12,99	16	113	65	43	48	TTS300B-1250-DR3-ZYL-16-MN	30839681
13,00 - 13,49	16	115	67	45	48	TTS300B-1300-DR3-ZYL-16-MN	30839682
13,50 - 13,99	16	117	69	46	48	TTS300B-1350-DR3-ZYL-16-MN	30839683
15,50 - 16,49	20	131	81	54	50	TTS300B-1550-DR3-ZYL-20-MN	30839687
16,50 - 17,49	20	135	85	58	50	TTS300B-1650-DR3-ZYL-20-MN	30839688
19,50 - 20,49	25	155	99	68	56	TTS300B-1950-DR3-ZYL-25-MN	30839691
22,50 - 23,49	25	168	112	78	56	TTS300B-2250-DR3-ZYL-25-MN	30839694
23,50 - 24,49	25	173	117	81	56	TTS300B-2350-DR3-ZYL-25-MN	30839695
25,50 - 26,49	32	186	126	87	60	TTS300B-2550-DR3-ZYL-32-MN	30839697
27,50 - 28,49	32	195	135	94	60	TTS300B-2750-DR3-ZYL-32-MN	30839699
28,50 - 29,49	32	200	140	97	60	TTS300B-2850-DR3-ZYL-32-MN	30839700
29,50 - 30,49	32	204	144	101	60	TTS300B-2950-DR3-ZYL-32-MN	30839701
30,50 - 31,49	32	209	149	104	60	TTS300B-3050-DR3-ZYL-32-MN	30839702
31,50 - 32,49	32	213	153	107	60	TTS300B-3150-DR3-ZYL-32-MN	30839703

Medidas en mm.

Ejecuciones especiales a petición.

Portaherramientas para cabezal intercambiable TTS

TTS300 con sistema de sujeción axial para broca de cabezal intercambiable TTD-Tritan (5xD), con suministro de refrigerante interior

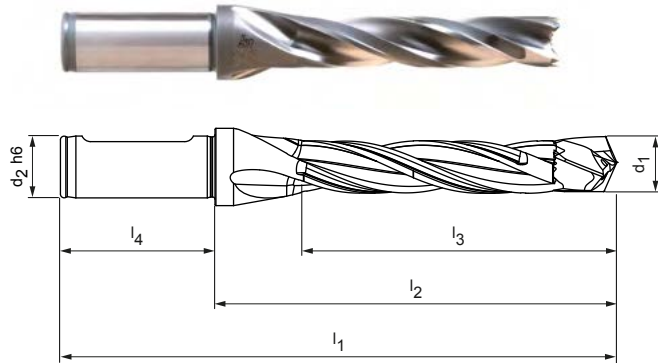

Ejecución:

Diámetro de broca:

12,00 – 32,49 mm

Sistema de cambio:

Sujeción central a través del orificio de refrigerante

Observación:

Llave de montaje incluida en el volumen de suministro.



Serie preferente disponible en stock

Dimensiones						Forma del mango HB	
d ₁	d ₂ h6	l ₁	l ₂	l ₃	l ₄	Especificación	Referencia
14,00 - 14,49	16	149	101	77	48	TTS300B-1400-DR5-ZYL-16-MN	30839708
15,00 - 15,49	16	155	107	82	48	TTS300B-1500-DR5-ZYL-16-MN	30839710
16,50 - 17,49	20	170	120	93	50	TTS300B-1650-DR5-ZYL-20-MN	30839712
17,50 - 18,49	20	177	127	98	50	TTS300B-1750-DR5-ZYL-20-MN	30839713
23,50 - 24,49	25	222	166	130	56	TTS300B-2350-DR5-ZYL-25-MN	30839719
24,50 - 25,49	32	233	173	135	60	TTS300B-2450-DR5-ZYL-32-MN	30839720
26,50 - 27,49	32	246	186	146	60	TTS300B-2650-DR5-ZYL-32-MN	30839722

Disponible a petición

Dimensiones						Forma del mango HB	
d ₁	d ₂ h6	l ₁	l ₂	l ₃	l ₄	Especificación	Referencia
12,00 - 12,49	16	136	88	66	48	TTS300B-1200-DR5-ZYL-16-MN	30839704
12,50 - 12,99	16	139	91	69	48	TTS300B-1250-DR5-ZYL-16-MN	30839705
13,00 - 13,49	16	142	94	71	48	TTS300B-1300-DR5-ZYL-16-MN	30839706
13,50 - 13,99	16	145	97	74	48	TTS300B-1350-DR5-ZYL-16-MN	30839707
14,50 - 14,99	16	152	104	79	48	TTS300B-1450-DR5-ZYL-16-MN	30839709
15,50 - 16,49	20	164	114	87	50	TTS300B-1550-DR5-ZYL-20-MN	30839711
18,50 - 19,49	25	189	133	103	56	TTS300B-1850-DR5-ZYL-25-MN	30839714
19,50 - 20,49	25	196	140	109	56	TTS300B-1950-DR5-ZYL-25-MN	30839715
20,50 - 21,49	25	202	146	114	56	TTS300B-2050-DR5-ZYL-25-MN	30839716
21,50 - 22,49	25	209	153	119	56	TTS300B-2150-DR5-ZYL-25-MN	30839717
22,50 - 23,49	25	215	159	124	56	TTS300B-2250-DR5-ZYL-25-MN	30839718
25,50 - 26,49	32	239	179	140	60	TTS300B-2550-DR5-ZYL-32-MN	30839721
27,50 - 28,49	32	252	192	151	60	TTS300B-2750-DR5-ZYL-32-MN	30839723
28,50 - 29,49	32	259	199	156	60	TTS300B-2850-DR5-ZYL-32-MN	30839724
29,50 - 30,49	32	265	205	162	60	TTS300B-2950-DR5-ZYL-32-MN	30839725
30,50 - 31,49	32	272	212	167	60	TTS300B-3050-DR5-ZYL-32-MN	30839726
31,50 - 32,49	32	278	218	172	60	TTS300B-3150-DR5-ZYL-32-MN	30839727

Medidas en mm.

Ejecuciones especiales a petición.

Portaherramientas para cabezal intercambiable TTS

TTS300 con sistema de sujeción axial para broca de cabezal intercambiable TTD-Tritan (8xD), con suministro de refrigerante interior

Ejecución:

Diámetro de broca:

12,00 – 32,49 mm

Sistema de cambio:

Sujeción central a través del orificio de refrigerante

Observación:

Llave de montaje incluida en el volumen de suministro.

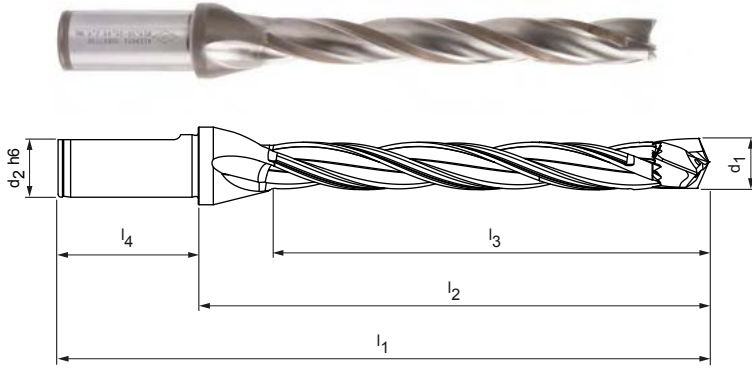

Serie preferente disponible en stock

Dimensiones						Forma del mango HB	
d ₁	d ₂ h6	l ₁	l ₂	l ₃	l ₄	Especificación	Referencia
15,50 - 16,49	20	213	163	137	50	TTS300B-1550-DR8-ZYL-20-MN	30867702
20,50 - 21,49	25	267	211	178	56	TTS300B-2050-DR8-ZYL-25-MN	30867707

Disponible a petición

Dimensiones						Forma del mango HB	
d ₁	d ₂ h6	l ₁	l ₂	l ₃	l ₄	Especificación	Referencia
12,00 - 12,49	16	173	125	104	48	TTS300B-1200-DR8-ZYL-16-MN	30867695
12,50 - 12,99	16	178	130	108	48	TTS300B-1250-DR8-ZYL-16-MN	30867696
13,00 - 13,49	16	183	135	112	48	TTS300B-1300-DR8-ZYL-16-MN	30867697
13,50 - 13,99	16	187	139	116	48	TTS300B-1350-DR8-ZYL-16-MN	30867698
14,00 - 14,49	16	192	144	120	48	TTS300B-1400-DR8-ZYL-16-MN	30867699
14,50 - 14,99	16	197	149	124	48	TTS300B-1450-DR8-ZYL-16-MN	30867700
15,00 - 15,49	16	202	154	129	48	TTS300B-1500-DR8-ZYL-16-MN	30867701
16,50 - 17,49	20	223	173	145	50	TTS300B-1650-DR8-ZYL-20-MN	30867703
17,50 - 18,49	20	232	182	153	50	TTS300B-1750-DR8-ZYL-20-MN	30867704
18,50 - 19,49	25	248	192	162	56	TTS300B-1850-DR8-ZYL-25-MN	30867705
19,50 - 20,49	25	257	201	170	56	TTS300B-1950-DR8-ZYL-25-MN	30867706
21,50 - 22,49	25	276	220	187	56	TTS300B-2150-DR8-ZYL-25-MN	30867708
22,50 - 23,49	25	286	230	195	56	TTS300B-2250-DR8-ZYL-25-MN	30867709
23,50 - 24,49	25	295	239	203	56	TTS300B-2350-DR8-ZYL-25-MN	30867710
24,50 - 25,49	32	309	249	212	60	TTS300B-2450-DR8-ZYL-32-MN	30867711
25,50 - 26,49	32	319	259	220	60	TTS300B-2550-DR8-ZYL-32-MN	30885879
26,50 - 27,49	32	328	268	228	60	TTS300B-2650-DR8-ZYL-32-MN	30867713
27,50 - 28,49	32	338	278	236	60	TTS300B-2750-DR8-ZYL-32-MN	30867714
28,50 - 29,49	32	342	282	245	60	TTS300B-2850-DR8-ZYL-32-MN	30867715
29,50 - 30,49	32	352	292	253	60	TTS300B-2950-DR8-ZYL-32-MN	30867716
30,50 - 31,49	32	361	301	261	60	TTS300B-3050-DR8-ZYL-32-MN	30867717
31,50 - 32,49	32	371	311	270	60	TTS300B-3150-DR8-ZYL-32-MN	30867718

Medidas en mm.

Ejecuciones especiales a petición.

Accesorios y refacciones para TTD-Tritan



Llaves TORX®

Rango de diámetros Cabezal de taladrado intercambiable TTD-Tritan	TORX®	Par de apriete tornillo de apriete especial [Nm]	Referencia
			para longitud de portaherramientas 3xD, 5xD y 8xD
12,00 - 12,49	6	0,4	30890316
12,50 - 12,99			
13,00 - 13,49			
13,50 - 13,99			
14,00 - 14,49	7	0,7	30890318
14,50 - 14,99			
15,00 - 15,49			
15,50 - 16,49			
16,50 - 17,49	8	1,3	30890321
17,50 - 18,49			
18,50 - 19,49			
19,50 - 20,49			
20,50 - 21,49	10	2	30890323
21,50 - 22,49			
22,50 - 23,49			
23,50 - 24,49			
24,50 - 25,49	15	3,1	30890326
25,50 - 26,49			
26,50 - 27,49			
27,50 - 28,49		5,6	
28,50 - 29,49			
29,50 - 30,49			
30,50 - 31,49			
31,50 - 32,49			

Llave dinamométrica

Accesorios	Rango de pares de apriete [Nm]	Referencia
Llave dinamométrica 	0,2 - 1,2	30911425
Llave dinamométrica 	1,0 - 6,0	30911426

Mango para llave TORX®

Refacciones	Mango enchufable	Referencia
Multimango 	Hexágono interior 1/4"	30918896

Recomendación de valores de corte para brocas de cabezal intercambiable TTD-Tritan

Avance y velocidad de corte

Tipo 01 – Uni

Grupo de arranque de virutas de Mapal*		Material	Rigidez/dureza [N/mm ²] [HRC]
P	P1	P1.1 Aceros de construcción, para tornos automáticos, de cementación y revenidos, no aleados	< 700
		P1.2 Aceros de construcción, para tornos automáticos, de cementación y revenidos, no aleados	< 1200
	P2	P2.1 Aceros nitrurados, de cementación y aceros revenidos, aleados	< 900
		P2.2 Aceros nitrurados, de cementación y aceros revenidos, aleados	< 1400
	P3	P3.1 Aceros para herramientas, rodamientos, resortes y rápidos**	< 800
		P3.2 Aceros para herramientas, rodamientos, resortes y rápidos**	< 1000
		P3.3 Aceros para herramientas, rodamientos, resortes y rápidos**	< 1500
	P5	P5.1 Fundición de acero	
K	K1	K1.1 Hierro fundido con grafito laminar (fundición gris), GJL	< 300
		K2.1 Hierro fundido con grafito esferoidal, GJS	< 500
	K2	K2.2 Hierro fundido con grafito esferoidal, GJS	≤ 800
		K2.3 Hierro fundido con grafito esferoidal, GJS	> 800
	K3	K3.1 Hierro fundido con grafito vermicular, GJV; fundición maleable, GJM	< 500
		K3.2 Hierro fundido con grafito vermicular, GJV; fundición maleable, GJM	> 500

* Grupos de mecanizado MAPAL

** Si los componentes de aleación de Cr, Mo, Ni, V, W suman > 8 %, elegir el siguiente grupo de mecanizado MAPAL superior.

	Velocidad de corte v_c [m/min]				Avance f [mm] con diámetro de broca					
	Refrigeración interna	Refrigeración exterior	MMS	Aire	12,00	14,50	17,50	21,50	26,00	32,00
	90	80	80		0,38	0,42	0,46	0,50	0,53	0,54
	80	70	70		0,47	0,53	0,58	0,63	0,66	0,68
	90	75	75		0,45	0,50	0,55	0,59	0,62	0,64
	65	55	55		0,36	0,40	0,43	0,47	0,49	0,51
	70	60	60		0,40	0,45	0,49	0,53	0,56	0,58
	55	50	50		0,33	0,37	0,40	0,43	0,46	0,47
	55	40	45		0,26	0,28	0,31	0,33	0,35	0,36
	90	75	75		0,45	0,50	0,55	0,59	0,62	0,64
	110	75	75	75	0,62	0,69	0,77	0,83	0,88	0,90
	145	90	110	110	0,57	0,64	0,71	0,77	0,81	0,83
	90	70	70		0,49	0,55	0,61	0,66	0,69	0,71
	55	35	45		0,33	0,37	0,40	0,43	0,46	0,47
	80	70	70		0,53	0,59	0,65	0,71	0,75	0,77
	70	65	65		0,43	0,47	0,52	0,56	0,59	0,61

Los valores de corte indicados son de referencia.

Los datos óptimos para cada situación de mecanizado deben determinarse mediante ensayos o durante el propio proceso de mecanizado.



BARRENADO EN SOLIDO CON INSERTOS DE CORTE

Barrenado en solido con insertos de corte

Brocas con insertos de corte	240
Inserto de corte radial WOGT, tres filos	241

Anexo técnico

Recomendación de valores de corte para brocas con insertos de corte ..	242
Indicaciones de aplicación	744

BARRENADO EN SOLIDO CON INSERTOS DE CORTE

Los insertos de corte para el barrenado en sólido en aluminio convencen por sus tres filos de corte útiles y un sólido recubrimiento de diamante CVD. Los insertos están disponibles en cinco tamaños. Esto significa que pueden utilizarse en una gama muy amplia de aplicaciones.

Las herramientas especiales escalonadas de una o varias etapas se caracterizan por una rentabilidad extremadamente alta y un fácil manejo.



Valores prácticos

Material: AISi1 v_c : 800 - 1000 m/min
 Diámetro: 39,0 mm f : 0,30 - 0,45 mm
 Profundidad de taladrado: 65 mm

Vida útil por filo de corte

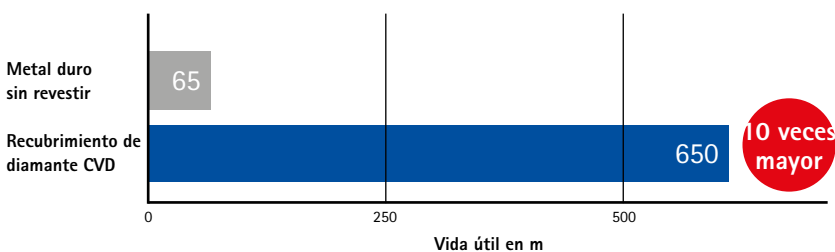

RESUMEN

- Soluciones personalizadas para: \varnothing 16-54,9 mm
- Barrenado en sólido de AISi1 a AISi12
- Con refrigeración interna, también posibilidad de MQL
- Una o varias etapas con insertos de corte o escalón de mandrinado PCD

VENTAJAS

- Extremadamente rentable con máxima productividad
- Amplia gama de aplicaciones
- Manejo sencillo



Cinco tamaños de inserto de corte para el rango de diámetro de 16 de 54,9 mm.

WOGT

Inserto de corte radial, de tres filos



	Metal duro	
Material	N	
	Al aleado ← resistente al desgaste	Cu aleado → tenaz
Clase de materiales de corte	HC698	
Diseño de filo de inserto	X40	

Rango de ϕ [mm]

WOGT030206N-...-...	16,0 - 20,9	31033174
WOGT040206N-...-...	21,0 - 25,9	31033175
WOGT053006N-...-...	26,0 - 30,9	31033177
WOGT063008N-...-...	31,0 - 44,9	30787196
WOGT073808N-...-...	45,0 - 54,9	31033178

Para el código de denominación, véase la página 676. Para el resumen de los materiales de corte, véase la página 672.

Accesorios para insertos de corte radiales

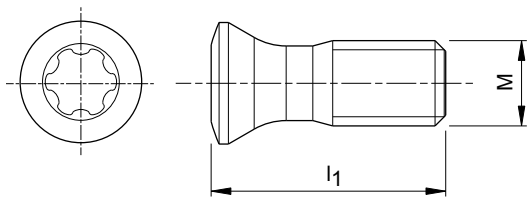

Inserto de corte	Tamaño del inserto de corte reversible	Tornillo de sujeción					Destornillador
		Dimensión [MxI]	Denominación	Par de apriete [Nm]	Tamaño Torx	Referencia	Referencia
WOGT... 	0302	M2x4.95	MN659 M2x4.95-TX6-IP	0,4	TX6-IP	10002712	30414758
	0402	M2.2x6	MN659 M2.2x6-TX7-IP	0,9	TX7-IP	31074485	30414759
	0530	M3x8.5	MN659 M3x8.5-TX8-IP	1,5	TX8-IP	31074486	30414760
	0630	M3.5x9	MN659 M3.5x9-TX15-IP	2,8	TX15-IP	10105078	30414764
	0738	M4x9.4	MN659 M4x9.4-TX15-IP	3,5	TX15-IP	30480629	30414764

Recomendación de valores de corte para brocas con insertos de corte HX

Avance y velocidad de corte

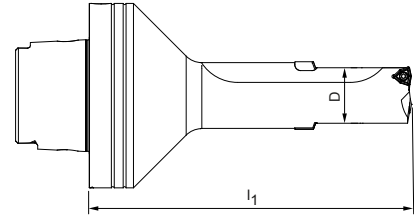

Brocas con insertos de corte

Valores iniciales para velocidad de corte y avance con WOGT...-X40-HC698

Grupo de arranque de virutas de Mapal*	Material	Rigidez/dureza [N/mm ²] [HRC]
N1	N1.1 Aluminio, aleado y no aleado < 3 % Si	
	N1.2 Aluminio, aleado ≤ 7 % Si	
	N1.3 Aluminio, aleado > 7-12 % Si	
	N1.4 Aluminio, aleado > 12 % Si	
N2	N2.1 Cobre, no aleado y de baja aleación	< 300
	N2.2 Cobre, aleado	> 300
	N2.3 Latón, bronce, fundición roja	< 1200
N3	N3.1 Grafito	
N4	N4.1 Plástico, termoplásticos	
	N4.2 Plástico, plásticos termoestables	
	N4.3 Plástico, espumas	

Factor de corrección: Taladrado piloto/salida de la broca		
l_1	v_c	f_z
3xD	0,8	0,7
4xD	0,7	0,6
5xD	0,6	0,5

	Velocidad de corte v_c [m/min]	Avance f [mm] con rango de diámetros de broca [mm]				
		16,00 - 20,90	21,00 - 25,90	26,00 - 30,90	31,00 - 44,90	45,00 - 54,90
	300 - 1000	0,08 - 0,20	0,12 - 0,22	0,14 - 0,30	0,16 - 0,40	0,20 - 0,45
	230 - 900	0,06 - 0,18	0,10 - 0,20	0,12 - 0,25	0,14 - 0,30	0,18 - 0,35
	220 - 800	0,05 - 0,15	0,08 - 0,18	0,10 - 0,20	0,12 - 0,25	0,15 - 0,30
	200 - 700	0,05 - 0,15	0,08 - 0,18	0,10 - 0,20	0,12 - 0,25	0,15 - 0,30

Los valores de corte indicados son de referencia.

Los datos óptimos para cada situación de mecanizado deben determinarse mediante ensayos o durante el propio proceso de mecanizado.



TALADRADO

Broca piloto

Tritan-Spot-Drill-Steel	246
ECU-Centre-Drill	248
CPD-Spot-Drill	249
Portaherramientas para cabezal intercambiable CFS	250

Anexo técnico

Recomendación de valores de corte	251
---	-----

Tritan-Spot-Drill-Steel

Broca piloto NC completa en metal duro
SCD670, suministro de refrigerante exterior

Ejecución:

Diámetro de broca: 4,00 – 20,00 mm
Forma del mango: HA (DIN 6535)
Material de corte: HP358
Número de insertos: 3
Ángulo de la punta: 155°

Aplicación:

Broca piloto NC especial para den
Tritan-Drill-Steel.

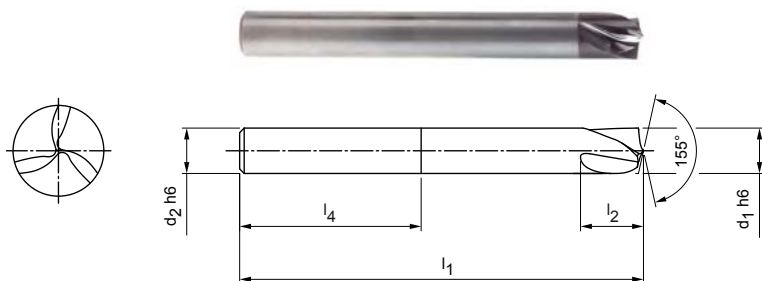

Serie preferente disponible en stock

Dimensiones					Forma del mango HA	
d ₁ h6	d ₂ h6	l ₁	l ₂	l ₄	Especificación	Referencia
4,00	4	55	6	28	SCD670-0400-3-0-155HA-HP358	30980587
5,00	6	62	7	36	SCD670-0500-3-0-155HA-HP358	30980588
6,00	6	66	9	36	SCD670-0600-3-0-155HA-HP358	30980589
8,00	8	79	11	36	SCD670-0800-3-0-155HA-HP358	30980590
10,00	10	89	14	40	SCD670-1000-3-0-155HA-HP358	30980592
12,00	12	102	17	45	SCD670-1200-3-0-155HA-HP358	30980594
16,00	16	115	23	48	SCD670-1600-3-0-155HA-HP358	30980595
20,00	20	131	28	50	SCD670-2000-3-0-155HA-HP358	30980596

Profundidades de taladrado piloto

d ₁ h6	d ₂ h6	l ₁	l ₂	l ₄	Máxima profundidad de taladrado piloto*	Mínima profundidad de taladrado piloto**
4,00	4	55	6	28	0,40	0,24
5,00	6	62	7	36	0,50	0,30
6,00	6	66	9	36	0,60	0,36
8,00	8	79	11	36	0,80	0,48
10,00	10	89	14	40	1,00	0,60
12,00	12	102	17	45	1,20	0,72
16,00	16	115	23	48	1,60	0,96
20,00	20	131	28	50	2,00	1,20

* 10 % del Ø nominal

** 6 % del Ø nominal

Medidas en mm.

Para la recomendación de valores de corte, véase al final del capítulo.

Ejecuciones especiales y otros recubrimientos a petición.

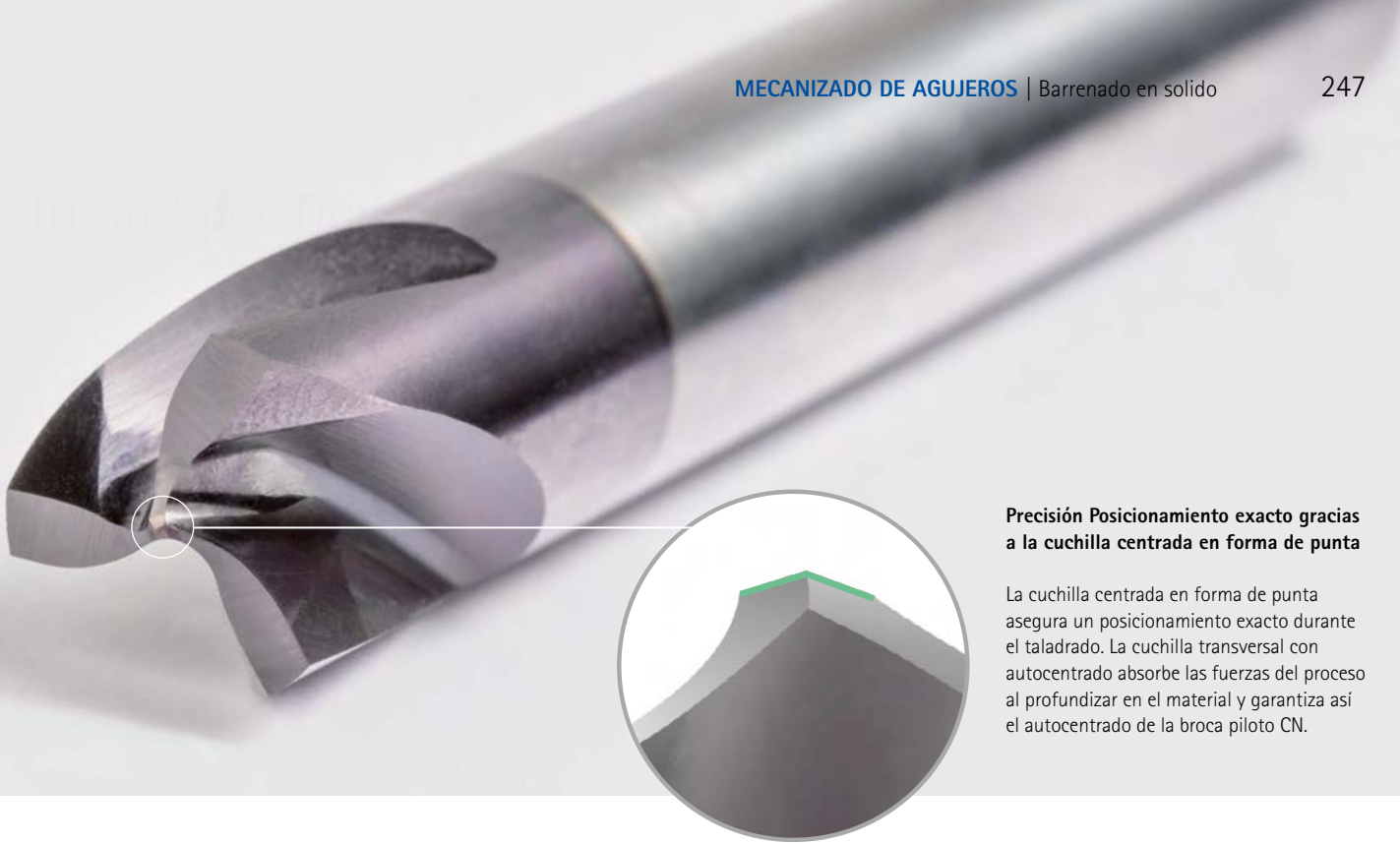

Precisión Posicionamiento exacto gracias a la cuchilla centrada en forma de punta

La cuchilla centrada en forma de punta asegura un posicionamiento exacto durante el taladrado. La cuchilla transversal con autocentrado absorbe las fuerzas del proceso al profundizar en el material y garantiza así el autocentrado de la broca piloto CN.



Las puntas de ángulo de la Tritan-Spot-Drill-Steel (155°) y la Tritan-Drill-Steel (140°/145°) están perfectamente adaptadas entre sí.

La Tritan-Drill-Steel está disponible en:



Estrategia de taladrado de 3xD hasta 12xD:

Profundidad de taladrado máxima: 10% (Indicación del % del diámetro nominal)

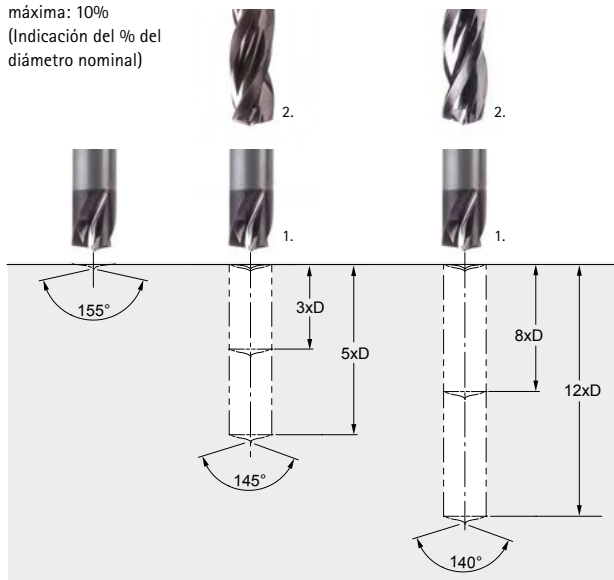

RESUMEN

- Broca piloto NC de tres filos con punta de ángulo de 155°
- Se adapta perfectamente a la Tritan-Drill-Steel
- Gran precisión de posicionamiento
- Cuchilla transversal con autocentrado
- También adecuada para situaciones de taladrado difíciles

ECU-Centre-Drill

Broca de centrar completa en metal duro
SCD450

Ejecución:

Diámetro de broca: 0,50 – 2,50 mm
Material de corte: HU318
Número de insertos: 2
Número de bisel guía: 2
Ángulo de la punta: 120°/60°
Ángulo de hélice: 5°

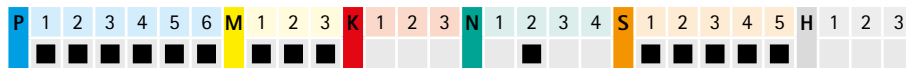
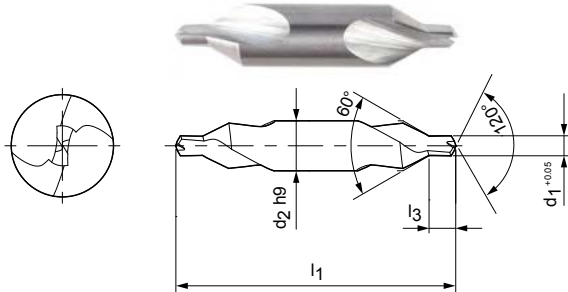

Serie preferente disponible en stock

Dimensiones				Especificación	Referencia
d_1 (0 +0,05)	d_2 h9	l_1	l_3		
0,50*	3,15	20	0,8	SCD450-0050-2-2-120HA-HU318	30561506
0,80*	3,15	20	1,1	SCD450-0080-2-2-120HA-HU318	30561507
1,00	3,15	31,5	1,3	SCD450-0100-2-2-120HA-HU318	30561508
1,25	3,15	31,5	1,6	SCD450-0125-2-2-120HA-HU318	30561509
1,60	4	35,5	2	SCD450-0160-2-2-120HA-HU318	30561510
2,00	5	40	2,5	SCD450-0200-2-2-120HA-HU318	30561511
2,50	6,3	45	3,1	SCD450-0250-2-2-120HA-HU318	30561512

Medidas en mm.

* Con inserto por un lado.

Para la recomendación de valores de corte, véase al final del capítulo.

Ejecuciones especiales y otros recubrimientos a petición.

CPD-Spot-Drill

Ejecución con interfaz CFS
CPD100

Ejecución:

Diámetro de broca: 8,00 - 20,00 mm
Material de corte: HP338
Número de insertos: 2
Ángulo de hélice: 15°
Ángulo de la punta: 90°

Aplicación:

Taladrado de centrado.

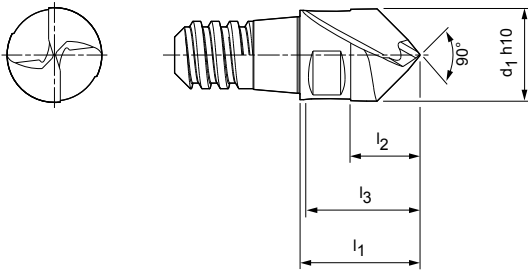

Serie preferente disponible en stock

Dimensiones					z	a _p máx.	ANCHO DE LLAVE	Especificación	Referencia
d ₁ h10	Tamaño CFS	l ₁	l ₂	l ₃					
8,00	6	11	6	10	2	4	SW 6	CPD100-0800Z02-W090-06-HP338	30371388
10,00	8	13	7,5	12	2	5	SW 8	CPD100-1000Z02-W090-08-HP338	30371389
12,00	10	16	9	15	2	6	SW 10	CPD100-1200Z02-W090-10-HP338	30371390
16,00	12	20	12	18	2	8	SW 13	CPD100-1600Z02-W090-12-HP338	30371391
20,00	16	25	15	23	2	10	SW 16	CPD100-2000Z02-W090-16-HP338	30371393

Accesorios

	Portaherramientas para cabezal intercambiable CFS CFS201	Página 250
---	--	------------

Medidas en mm.

Para la recomendación de valores de corte, véase al final del capítulo.

Ejecuciones especiales y otros recubrimientos a petición.

Portaherramientas para cabezal intercambiable CFS

Ejecución cónica, con refrigeración interna
CFS201

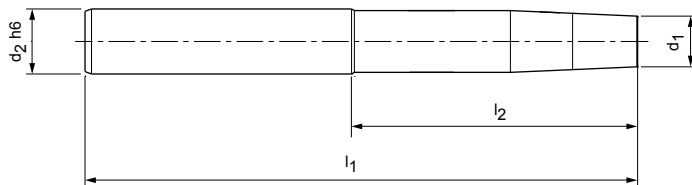

Ejecución de acero

Tamaño CFS	Dimensiones				Especificación	Referencia
	d_1	d_2 h6	l_1	l_2		
6	7,8	10	60	20	CFS201N-06-020-ZYL-HA10-S	30393776
8	9,8	16	70	30	CFS201N-08-030-ZYL-HA16-S	30393787
8	9,8	16	90	40	CFS201N-08-040-ZYL-HA16-S	30393788
10	11,8	16	70	30	CFS201N-10-030-ZYL-HA16-S	30393798
10	11,8	16	90	42	CFS201N-10-042-ZYL-HA16-S	30393799
12	15,8	20	80	30	CFS201N-12-030-ZYL-HA20-S	30393963
12	15,8	20	105	55	CFS201N-12-055-ZYL-HA20-S	30393964
16	19,8	25	90	40	CFS201N-16-040-ZYL-HA25-S	30393976

Ejecución de metal duro

6	7,8	10	110	70	CFS201N-06-070-ZYL-HA10-H	30393779
8	9,8	16	110	60	CFS201N-08-060-ZYL-HA16-H	30393790
10	11,8	20	110	60	CFS201N-10-060-ZYL-HA20-H	30393801
10	11,8	20	150	100	CFS201N-10-100-ZYL-HA20-H	30393802
12	15,8	20	130	80	CFS201N-12-080-ZYL-HA20-H	30393966
12	15,8	20	150	100	CFS201N-12-100-ZYL-HA20-H	30393967
16	19,8	25	150	94	CFS201N-16-094-ZYL-HA25-H	30393979

Recomendación de valores de corte para brocas piloto

Avance y velocidad de corte

CPD-Spot-Drill | CPD100

Grupo de arranque de virutas de Mapal*	Material	Rigidez/dureza [N/mm ²] [HRC]	Refrigeración			v _c [m/min]	f _z [mm]					
			MMS/aire	Seco	KSS		Diámetro de broca [mm]					
							8,00	10,00	12,00	16,00	20,00	
P	P1.1	Aceros de construcción, para tornos automáticos, de cementación y revenidos, no aleados	< 700	✓	✓	✓	160	0,084	0,100	0,115	0,141	0,161
	P1.2	Aceros de construcción, para tornos automáticos, de cementación y revenidos, no aleados	< 1200	✓	✓	✓	130	0,078	0,094	0,108	0,131	0,150
	P2.1	Aceros nitrurados, de cementación y aceros revenidos, aleados	< 900	✓	✓	✓	145	0,084	0,100	0,115	0,141	0,161
	P2.2	Aceros nitrurados, de cementación y aceros revenidos, aleados	< 1400	✓		✓	100	0,070	0,084	0,096	0,117	0,134
	P3.1	Aceros para herramientas, rodamientos, resortes y rápidos**	< 800	✓	✓	✓	95	0,081	0,097	0,111	0,136	0,156
	P3.2	Aceros para herramientas, rodamientos, resortes y rápidos**	< 1000	✓		✓	85	0,077	0,092	0,106	0,129	0,148
	P3.3	Aceros para herramientas, rodamientos, resortes y rápidos**	< 1500	✓		✓	80	0,073	0,087	0,100	0,122	0,140
	P4.1	Aceros inoxidables, ferríticos y martensíticos		✓		✓	65	0,056	0,067	0,077	0,094	0,107
	P5.1	Fundición de acero				✓	95	0,081	0,097	0,111	0,136	0,156
	P6.1	Fundición de acero inoxidable, ferrítica y martensítica				✓	65	0,039	0,047	0,054	0,066	0,075
M	M1.1	Aceros inoxidables, austeníticos	< 700	✓		✓	45	0,049	0,059	0,067	0,082	0,094
	M1.2	Aceros inoxidables, ferríticos/austeníticos (dúplex)	< 1000			✓	40	0,040	0,048	0,056	0,068	0,078
	M2.1	Fundición de acero inoxidable, austenítica	< 700	✓		✓	50	0,053	0,064	0,073	0,089	0,102
	M3.1	Fundición de acero inoxidable, ferrítica/austenítica (dúplex)	< 1000			✓	45	0,042	0,050	0,058	0,070	0,081
K	K1.1	Hierro fundido con grafito laminar (fundición gris), GJL	< 300	✓	✓	✓	175	0,140	0,167	0,192	0,235	0,268
	K2.1	Hierro fundido con grafito esferoidal, GJS	< 500	✓	✓	✓	160	0,119	0,142	0,163	0,199	0,228
	K2.2	Hierro fundido con grafito esferoidal, GJS	500-800	✓	✓	✓	130	0,098	0,117	0,134	0,164	0,188
	K2.3	Hierro fundido con grafito esferoidal, GJS	> 800	✓	✓	✓	70	0,056	0,067	0,077	0,094	0,107
	K3.1	Hierro fundido con grafito vermicular, GJV; fundición maleable, GJM	< 500	✓	✓	✓	115	0,098	0,117	0,134	0,164	0,188
	K3.2	Hierro fundido con grafito vermicular, GJV; fundición maleable, GJM	> 500	✓	✓	✓	110	0,084	0,100	0,115	0,141	0,161
N	N1.1	Aluminio, aleado y no aleado < 3 % Si		✓	✓	✓	610	0,142	0,170	0,196	0,239	0,273
	N1.2	Aluminio, aleado ≤ 7 % Si		✓	✓	✓	405	0,149	0,179	0,206	0,251	0,287
	N1.3	Aluminio, aleado > 7-12 % Si		✓	✓	✓	325	0,156	0,187	0,215	0,263	0,301
	N1.4	Aluminio, aleado > 12 % Si		✓	✓	✓	235	0,171	0,204	0,235	0,287	0,328
	N2.1	Cobre, no aleado y de baja aleación	< 300	✓	✓	✓	235	0,114	0,136	0,157	0,191	0,219
	N2.2	Cobre, aleado	> 300	✓	✓	✓	175	0,114	0,136	0,157	0,191	0,219
	N2.3	Latón, bronce, fundición roja	< 1200	✓	✓	✓	295	0,071	0,085	0,098	0,120	0,137

* Grupos de mecanizado MAPAL

** Si los componentes de aleación de Cr, Mo, Ni, V, W suman > 8 %, elegir el siguiente grupo de mecanizado MAPAL superior.

Los valores de trabajo indicados son de referencia.

Los datos óptimos para cada situación de mecanizado deben determinarse mediante ensayos o durante el propio proceso de mecanizado.

Recomendación de valores de corte para brocas piloto

Avance y velocidad de corte

Tritan-Spot-Drill-Steel | SCD670

Grupo de arranque de virutas de Mapal*		Material	Rigidez/dureza [N/mm ²] [HRC]
P	P1	P1.1 Aceros de construcción, para tornos automáticos, de cementación y revenidos, no aleados	< 700
		P1.2 Aceros de construcción, para tornos automáticos, de cementación y revenidos, no aleados	< 1200
	P2	P2.1 Aceros nitrurados, de cementación y aceros revenidos, aleados	< 900
		P2.2 Aceros nitrurados, de cementación y aceros revenidos, aleados	< 1400
	P3	P3.1 Aceros para herramientas, rodamientos, resortes y rápidos**	< 800
		P3.2 Aceros para herramientas, rodamientos, resortes y rápidos**	< 1000
		P3.3 Aceros para herramientas, rodamientos, resortes y rápidos**	< 1500
	P5	P5.1 Fundición de acero	
M	M1	M1.1 Aceros inoxidables, austeníticos	< 700
		M1.2 Aceros inoxidables, ferríticos/austeníticos (dúplex)	< 1000
	M2	M2.1 Fundición de acero inoxidable, austenítica	< 700
	M3	M3.1 Fundición de acero inoxidable, ferrítica/austenítica (dúplex)	< 1000
K	K1	K1.1 Hierro fundido con grafito laminar (fundición gris), GJL	< 300
		K2.1 Hierro fundido con grafito esferoidal, GJS	< 500
	K2	K2.2 Hierro fundido con grafito esferoidal, GJS	≤ 800
		K2.3 Hierro fundido con grafito esferoidal, GJS	> 800
	K3	K3.1 Hierro fundido con grafito vermicular, GJV; fundición maleable, GJM	< 500
		K3.2 Hierro fundido con grafito vermicular, GJV; fundición maleable, GJM	> 500
N	N1	N1.1 Aluminio, aleado y no aleado < 3 % Si	
		N1.2 Aluminio, aleado ≤ 7 % Si	
		N1.3 Aluminio, aleado > 7-12 % Si	
		N1.4 Aluminio, aleado > 12 % Si	
	N2	N2.1 Cobre, no aleado y de baja aleación	< 300
		N2.2 Cobre, aleado	> 300
		N2.3 Latón, bronce, fundición roja	< 1200
	N4	N4.1 Plástico, termoplásticos	
		N4.2 Plástico, plásticos termoestables	
		N4.3 Plástico, espumas	
S	S1	S1.1 Titanio, aleaciones de titanio	< 400
		S2.1 Titanio, aleaciones de titanio	< 1200
	S2	S2.2 Titanio, aleaciones de titanio	> 1200
		S3.1 Níquel, no aleado y aleado	< 900
	S3	S3.2 Níquel, no aleado y aleado	> 900
		S4.1 Superaleación de gran resistencia al calor basada en Ni, Co y Fe	
	S5	S5.1 Aleaciones de wolframio y molibdeno	
H	H1	H1.1 Acero templado/fundición de acero	< 44
		H1.2 Acero templado/fundición de acero	< 55

* Grupos de mecanizado MAPAL

** Si los componentes de aleación de Cr, Mo, Ni, V, W suman > 8 %, elegir el siguiente grupo de mecanizado MAPAL superior.

	Velocidad de corte v_c [m/min]				Avance f [mm] con diámetro de broca					
	Refrigeración interna	Refrigeración exterior	MMS	Aire	4,00	5,50	7,50	10,50	14,50	20,00
	175	160	160		0,09	0,10	0,11	0,13	0,14	0,15
	160	130	130		0,11	0,12	0,14	0,16	0,17	0,18
	170	145	145		0,10	0,12	0,13	0,15	0,16	0,17
	120	100	100		0,08	0,09	0,11	0,12	0,13	0,14
	110	95	95		0,09	0,11	0,12	0,13	0,15	0,16
	90	85	85		0,08	0,09	0,10	0,11	0,12	0,13
	90	70	75		0,06	0,07	0,08	0,08	0,09	0,10
	110	95	95		0,10	0,12	0,13	0,15	0,16	0,17
	70	45	45		0,06	0,07	0,08	0,09	0,10	0,10
	75	50	50		0,06	0,07	0,08	0,09	0,10	0,10
	245	175	175	175	0,17	0,19	0,22	0,25	0,27	0,30
	225	140	170	170	0,16	0,18	0,20	0,23	0,25	0,27
	170	130	130		0,14	0,15	0,18	0,20	0,22	0,23
	100	70	85		0,09	0,10	0,12	0,13	0,14	0,15
	155	135	135		0,15	0,17	0,19	0,21	0,23	0,25
	135	120	120		0,12	0,13	0,15	0,17	0,19	0,20
	300	200	250		0,11	0,12	0,13	0,15	0,17	0,18
	250	180	200		0,14	0,15	0,18	0,20	0,22	0,23
	220	150	180		0,14	0,15	0,18	0,20	0,22	0,23
	180	120	150		0,14	0,15	0,18	0,20	0,22	0,23
	140	100			0,11	0,12	0,13	0,15	0,17	0,18
	120	90			0,14	0,15	0,18	0,20	0,22	0,23
	200	160	160	120	0,17	0,19	0,22	0,25	0,27	0,30
		60		50	0,09	0,10	0,12	0,13	0,14	0,15
		65		40	0,07	0,08	0,09	0,11	0,12	0,12
				400	0,07	0,08	0,09	0,11	0,12	0,12
	40	25			0,062	0,069	0,078	0,088	0,097	0,104
	30	20			0,053	0,059	0,067	0,075	0,083	0,089
	25	15			0,044	0,050	0,056	0,063	0,069	0,074
	20	15			0,035	0,040	0,045	0,050	0,055	0,059
	15	10			0,044	0,050	0,056	0,063	0,069	0,074
	15	10			0,035	0,040	0,045	0,050	0,055	0,059
	15	10			0,035	0,040	0,045	0,050	0,055	0,059
	80	80	80		0,078	0,087	0,098	0,109	0,120	0,128
	30	30	30		0,053	0,059	0,067	0,075	0,083	0,089

Los valores de corte indicados son de referencia.

Los datos óptimos para cada situación de mecanizado deben determinarse mediante ensayos o durante el propio proceso de mecanizado.

Recomendación de valores de corte para brocas piloto

Avance y velocidad de corte

ECU-Centre-Drill | SCD450

Grupo de arranque de virutas de Mapal*		Material	Rigidez/dureza [N/mm ²] [HRC]
P	P1	P1.1 Aceros de construcción, para tornos automáticos, de cementación y revenidos, no aleados	< 700
		P1.2 Aceros de construcción, para tornos automáticos, de cementación y revenidos, no aleados	< 1200
	P2	P2.1 Aceros nitrurados, de cementación y aceros revenidos, aleados	< 900
		P2.2 Aceros nitrurados, de cementación y aceros revenidos, aleados	< 1400
	P3	P3.1 Aceros para herramientas, rodamientos, resortes y rápidos**	< 800
		P3.2 Aceros para herramientas, rodamientos, resortes y rápidos**	< 1000
		P3.3 Aceros para herramientas, rodamientos, resortes y rápidos**	< 1500
	P4	P4.1 Aceros inoxidables, ferríticos y martensíticos	
	P5	P5.1 Fundición de acero	
	P6	P6.1 Fundición de acero inoxidable, ferrítica y martensítica	
M	M1	M1.1 Aceros inoxidables, austeníticos	< 700
		M1.2 Aceros inoxidables, ferríticos/austeníticos (dúplex)	< 1000
	M2	M2.1 Fundición de acero inoxidable, austenítica	< 700
	M3	M3.1 Fundición de acero inoxidable, ferrítica/austenítica (dúplex)	< 1000
N	N2	N2.1 Cobre, no aleado y de baja aleación	< 300
		N2.2 Cobre, aleado	> 300
		N2.3 Latón, bronce, fundición roja	< 1200
S	S1	S1.1 Titanio, aleaciones de titanio	< 400
		S2.1 Titanio, aleaciones de titanio	< 1200
	S2	S2.2 Titanio, aleaciones de titanio	> 1200
		S3.1 Níquel, no aleado y aleado	< 900
	S3	S3.2 Níquel, no aleado y aleado	> 900
		S4	S4.1 Superaleación de gran resistencia al calor basada en Ni, Co y Fe
S5	S5.1 Aleaciones de wolframio y molibdeno		

* Grupos de mecanizado MAPAL

** Si los componentes de aleación de Cr, Mo, Ni, V, W suman > 8 %, elegir el siguiente grupo de mecanizado MAPAL superior.

	Velocidad de corte v_c [m/min]				Avance f [mm] con diámetro de broca					
	Refrigeración interna	Refrigeración exterior	MMS	Aire	0,50	0,83	1,38	2,29	3,80	6,30
		70	70		0,01	0,01	0,02	0,02	0,03	0,04
		55	55		0,01	0,02	0,02	0,03	0,04	0,06
		65	65		0,01	0,01	0,02	0,03	0,04	0,05
		45	45		0,01	0,01	0,02	0,02	0,03	0,04
		50	50		0,01	0,01	0,02	0,02	0,03	0,05
		40	40		0,01	0,01	0,02	0,02	0,03	0,04
		35	40		0,01	0,01	0,01	0,02	0,02	0,03
		35	40		0,01	0,01	0,01	0,02	0,02	0,03
		65	65		0,01	0,01	0,02	0,03	0,04	0,05
		35	40		0,01	0,01	0,01	0,02	0,02	0,03
		30	30		0,01	0,01	0,01	0,02	0,02	0,03
		25	25		0,01	0,01	0,01	0,01	0,02	0,03
		30	30		0,01	0,01	0,01	0,02	0,02	0,03
		25	25		0,01	0,01	0,01	0,01	0,02	0,03
		85			0,01	0,01	0,02	0,02	0,03	0,04
		75			0,01	0,01	0,02	0,03	0,04	0,06
		135	135		0,01	0,01	0,02	0,03	0,04	0,07
		40	40		0,01	0,01	0,02	0,02	0,03	0,04
		35	35		0,01	0,01	0,02	0,02	0,03	0,04
		30	30		0,01	0,01	0,02	0,02	0,03	0,04
		25	25		0,01	0,01	0,02	0,02	0,03	0,04
		20	20		0,01	0,01	0,02	0,02	0,03	0,04
		20	20		0,01	0,01	0,02	0,02	0,03	0,04
	20	20		0,01	0,01	0,02	0,02	0,03	0,04	

Los valores de corte indicados son de referencia.

Los datos óptimos para cada situación de mecanizado deben determinarse mediante ensayos o durante el propio proceso de mecanizado.



TALADRADO ESCALONADO

Broca escalonada

Tritan-Step-Drill-Steel	258
MEGA-Step-Drill-Steel-Plus	259

Anexo técnico

Recomendación de valores de corte	262
---	-----

Tritan-Step-Drill-Steel

Broca escalonada completa en metal duro
SCD561, con suministro de refrigerante interior

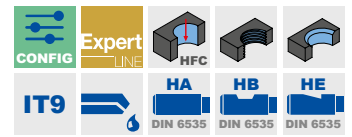
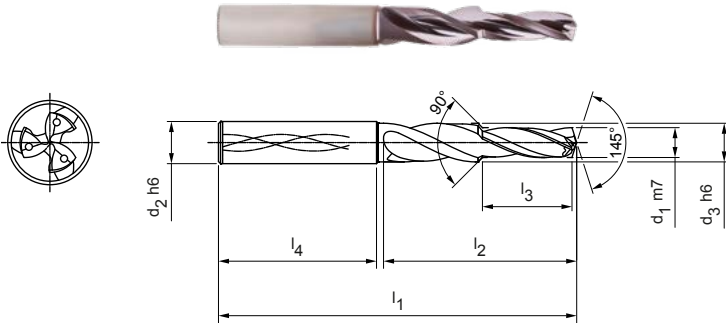

Ejecución:
 Diámetro de broca: 3,98 – 17,50 mm
 Tolerancia del agujero: IT 9 (alcanzable)
 Material de corte: HP835
 Número de insertos: 3
 Número de bisel guía: 3
 Ángulo de la punta: 145°
 Ángulo de hélice: 30°

Aplicación:
 Para agujero para roscar con avellanado de 90°.

Serie preferente disponible en stock en forma de mango HA

Dimensiones								Forma del mango HA	
Para roscas	d ₁ m7	d ₂ h6	d ₃ h6	l ₁	l ₂	l ₃	l ₄	Especificación	Referencia
M5	4,25	6	5,5	66	28	13,6	36	SCD561-0425-3-3-145HA-HP835	31053657
M6	5,10	8	6,6	79	41	16,5	36	SCD561-0510-3-3-145HA-HP835	31053658
M8	6,85	10	8,8	89	47	21	40	SCD561-0685-3-3-145HA-HP835	31053659
M8x1	7,10	10	8,8	89	47	21	40	SCD561-0710-3-3-145HA-HP835	31073436
M10	8,60	12	11	102	55	25,5	45	SCD561-0860-3-3-145HA-HP835	31053670
M10x1	9,10	12	11	102	55	25,5	45	SCD561-0910-3-3-145HA-HP835	31073438
M12	10,35	14	13,2	107	60	30	45	SCD561-1035-3-3-145HA-HP835	31053671
M16	14,15	18	17,6	123	73	38,5	48	SCD561-1415-3-3-145HA-HP835	31053672

Características configurables

Diámetro:
Diámetro seleccionable libremente en incrementos de 0,01 mm

Longitud del escalón
Longitud del escalón seleccionable libremente en incrementos de 0,01 mm

Forma del mango:
Forma del mango: HB | HE

Especificación
SCD561-[diámetro]-3-3-145[forma del mango]-HP835

Dimensiones de la serie configurable

d ₁ min.	d ₁ max.	d ₂ h6	d ₃ h6	l ₁	l ₂	l ₃ min.	l ₃ max.
3,98	4,50	6	5	66	28	4,00	15,4
4,51	5,50	6	6	66	28	4,50	15,4
5,51	6,50	8	7	79	41	5,50	22,55
6,51	7,50	8	8	79	41	6,50	22,55
7,51	8,50	10	9	89	47	7,50	25,85
8,51	9,50	10	10	89	47	8,50	25,85
9,51	11,50	12	12	102	55	9,50	30,25
11,51	13,50	14	14	107	60	11,50	33
13,51	15,50	16	16	115	65	13,50	35,75
15,51	17,50	18	18	123	73	15,50	40,15

Ejemplo:

SCD561-0431-3-3-145HE-HP835

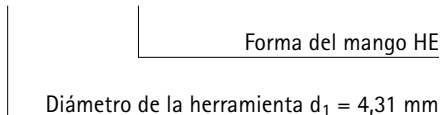

Medidas en mm.

Para la recomendación de valores de corte, véase al final del capítulo.
Ejecuciones especiales y otros recubrimientos a petición.

Agujeros lisos para roscar con bisel de 90°

según DIN 8378 con la Tritan-Step-Drill-Steel





MEGA-STEP-DRILL-STEEL-PLUS

Mecanizado rentable de agujeros para roscar (según DIN 8378)

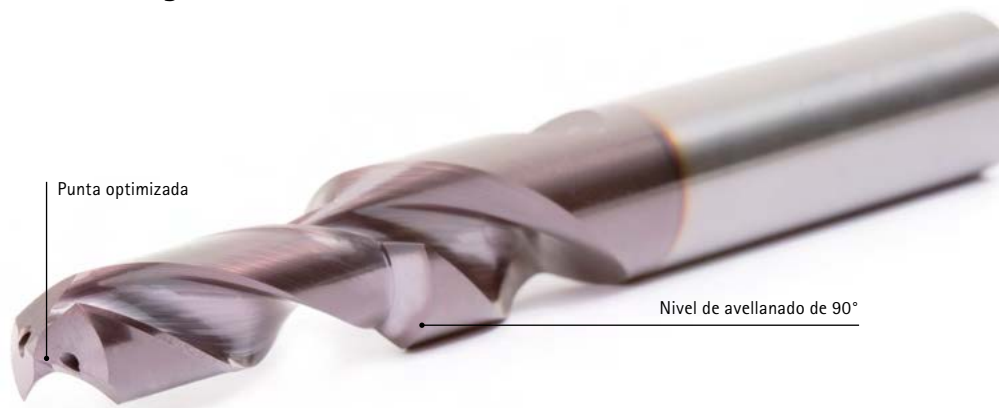
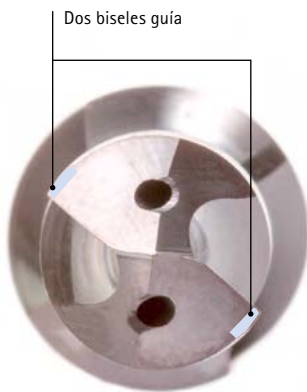

Taladrado de agujeros para rosca M10

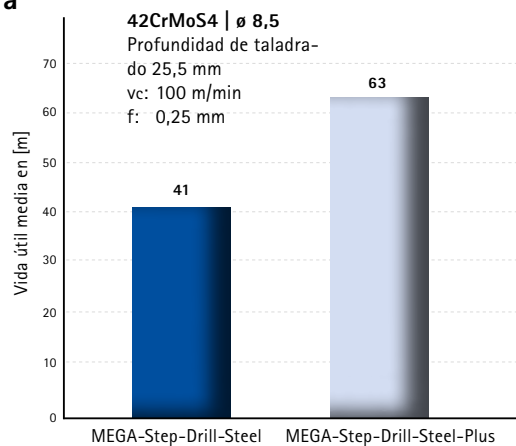

RESUMEN

- Actualización de la MEGA-Step-Drill-Steel con y sin refrigeración interior
- Recubrimiento innovador
- Micro y macrogeometría optimizadas
- Rango de diámetro de 2,50 a 15,00 mm

VENTAJAS

- Velocidad de corte un 15 % superior*
- Avance un 15 % superior*
- Vida útil un 50 % superior*

* En comparación con el modelo anterior

MEGA-Step-Drill-Steel-Plus

Broca escalonada completa en metal duro
SCD590, suministro de refrigerante exterior, producto sucesor de la MEGA-Step-Drill-Steel

Ejecución:
 Diámetro de broca: 2,50 – 14,00 mm
 Material de corte: HP358
 Número de insertos: 2
 Número de biseles guía: 2
 Ángulo de la punta: 140°
 Ángulo de hélice: 30°

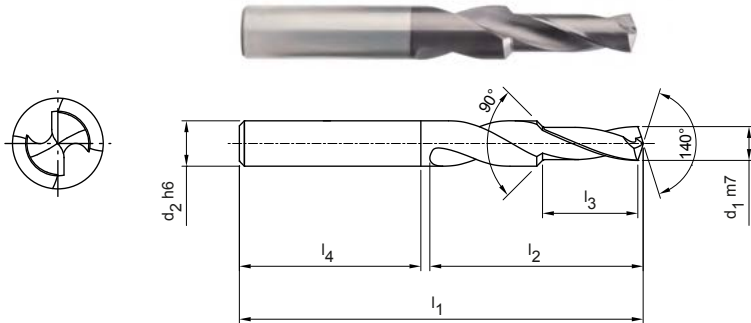

Serie preferente disponible en stock en forma de mango HA

		Dimensiones						Forma del mango HA	
Para roscas	Clase	d ₁ m7	d ₂ h6	l ₁	l ₂	l ₃	l ₄	Especificación	Referencia
M3	GB	2,50	6	62	20	8,8	36	SCD590-0250-2-2-140HA-HP358	31228957
M3	F0	2,80	6	62	20	8,8	36	SCD590-0280-2-2-140HA-HP358	31228958
M4	GB	3,30	6	62	24	11,4	36	SCD590-0330-2-2-140HA-HP358	31228959
M4	F0	3,70	6	62	24	11,4	36	SCD590-0370-2-2-140HA-HP358	31228960
M5	GB	4,20	6	66	28	13,6	36	SCD590-0420-2-2-140HA-HP358	31228961
M5	F0	4,65	6	66	28	13,6	36	SCD590-0465-2-2-140HA-HP358	31228962
M6	GB	5,00	8	79	34	16,5	36	SCD590-0500-2-2-140HA-HP358	31149619
M6	F0	5,55	8	79	34	16,5	36	SCD590-0555-2-2-140HA-HP358	31228963
M8	GB	6,80	10	89	47	21	40	SCD590-0680-2-2-140HA-HP358	31141315
M8	F0	7,45	10	89	47	21	40	SCD590-0745-2-2-140HA-HP358	31228964
M10	GB	8,50	12	102	55	25,5	45	SCD590-0850-2-2-140HA-HP358	31228965
M10	F0	9,30	12	102	55	25,5	45	SCD590-0930-2-2-140HA-HP358	31228966
M12	GB	10,20	14	107	60	30	45	SCD590-1020-2-2-140HA-HP358	31228967
M12	F0	11,20	14	107	60	30	45	SCD590-1120-2-2-140HA-HP358	31228968
M14	GB	12,00	16	115	65	34,5	48	SCD590-1200-2-2-140HA-HP358	31149650
M16	GB	14,00	18	123	73	38,5	48	SCD590-1400-2-2-140HA-HP358	31228970

GB: Roscado de agujeros para rosca | F0: Laminación de roscas en agujeros para rosca

Características configurables

Forma del mango:
Forma del mango: HB | HE

Especificación
SCD590-0420-2-2-140[forma del mango]-HP358

Ejemplo:
SCD590-0420-2-2-140HE05-HP358

Forma del mango HE

Medidas en mm.
 Para la recomendación de valores de corte, véase al final del capítulo.
 Ejecuciones especiales y otros recubrimientos a petición.

MEGA-Step-Drill-Steel-Plus

Broca escalonada completa en metal duro

SCD591, con suministro de refrigerante interior, producto sucesor de la MEGA-Step-Drill-Steel

Ejecución:

Diámetro de broca: 3,30 - 14,00 mm

Material de corte: HP358

Número de insertos: 2

Número de biseles guía: 2

Ángulo de la punta: 140°

Ángulo de hélice: 30°

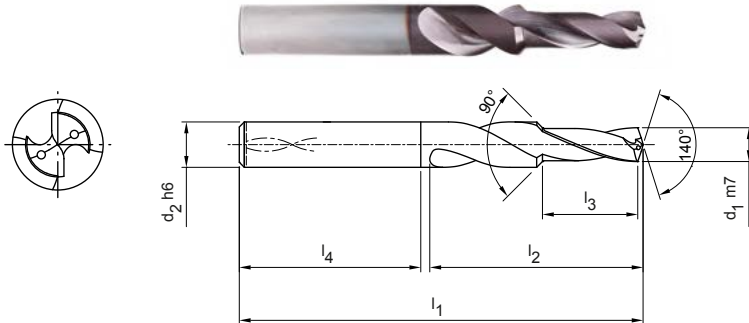

Serie preferente disponible en stock en forma de mango HA

Dimensiones								Forma del mango HA	
Para roscas	Clase	d ₁ m7	d ₂ h6	l ₁	l ₂	l ₃	l ₄	Especificación	Referencia
M4	GB	3,30	6	62	24	11,4	36	SCD591-0330-2-2-140HA-HP358	31140987
M4	F0	3,70	6	62	24	11,4	36	SCD591-0370-2-2-140HA-HP358	31140988
M5	GB	4,20	6	66	28	13,6	36	SCD591-0420-2-2-140HA-HP358	31140989
M6	GB	5,00	8	79	34	16,5	36	SCD591-0500-2-2-140HA-HP358	31140991
M6	F0	5,55	8	79	34	16,5	36	SCD591-0555-2-2-140HA-HP358	31140992
M8	GB	6,80	10	89	47	21	40	SCD591-0680-2-2-140HA-HP358	31140993
M8	F0	7,45	10	89	47	21	40	SCD591-0745-2-2-140HA-HP358	31140994
M10	GB	8,50	12	102	55	25,5	45	SCD591-0850-2-2-140HA-HP358	31140995
M10	F0	9,30	12	102	55	25,5	45	SCD591-0930-2-2-140HA-HP358	31140996
M12	GB	10,20	14	107	60	30	45	SCD591-1020-2-2-140HA-HP358	31140997
M12	GB	10,20	14	107	60	30	45	SCD591-1020-2-2-140HA-HP358	31140997

Disponible bajo petición

M12	F0	11,20	14	107	60	30	45	SCD591-1120-2-2-140HA-HP358	31140998
M16	GB	14,00	18	123	73	38,5	48	SCD591-1400-2-2-140HA-HP358	31140999

GB: Roscado de agujeros para rosca | F0: Laminación de roscas en agujeros para rosca

Características configurables

Forma del mango:
Forma del mango: HB | HE

Especificación
SCD591-0420-2-2-140[forma del mango]-HP358

Ejemplo:

SCD591-0420-2-2-140HE05-HP358

Forma del mango HE

Medidas en mm.

Para la recomendación de valores de corte, véase al final del capítulo.

Ejecuciones especiales y otros recubrimientos a petición.

Recomendación de valores de corte para brocas escalonadas

Avance y velocidad de corte

Tritan-Step-Drill-Steel | SCD561

Grupo de arranque de virutas de Mapal*		Material	Rigidez/dureza [N/mm ²] [HRC]
P	P1	P1.1 Aceros de construcción, para tornos automáticos, de cementación y revenidos, no aleados	< 700
		P1.2 Aceros de construcción, para tornos automáticos, de cementación y revenidos, no aleados	< 1200
	P2	P2.1 Aceros nitrurados, de cementación y aceros revenidos, aleados	< 900
		P2.2 Aceros nitrurados, de cementación y aceros revenidos, aleados	< 1400
	P3	P3.1 Aceros para herramientas, rodamientos, resortes y rápidos**	< 800
		P3.2 Aceros para herramientas, rodamientos, resortes y rápidos**	< 1000
		P3.3 Aceros para herramientas, rodamientos, resortes y rápidos**	< 1500
	P5	P5.1 Fundición de acero	
M	M1	M1.1 Aceros inoxidable, austeníticos	< 700
		M1.2 Aceros inoxidable, ferríticos/austeníticos (dúplex)	< 1000
K	K1	K1.1 Hierro fundido con grafito laminar (fundición gris), GJL	< 300
		K2.1 Hierro fundido con grafito esferoidal, GJS	< 500
	K2	K2.2 Hierro fundido con grafito esferoidal, GJS	≤ 800
		K2.3 Hierro fundido con grafito esferoidal, GJS	> 800
	K3	K3.1 Hierro fundido con grafito vermicular, GJV; fundición maleable, GJM	< 500
		K3.2 Hierro fundido con grafito vermicular, GJV; fundición maleable, GJM	> 500

* Grupos de mecanizado MAPAL

** Si los componentes de aleación de Cr, Mo, Ni, V, W suman > 8 %, elegir el siguiente grupo de mecanizado MAPAL superior.

	Velocidad de corte v_c [m/min]				Avance f [mm] con diámetro de broca					
	Refrigeración interna	Refrigeración exterior	MMS	Aire	4,00	5,50	7,50	10,50	14,50	20,00
	115	105	105		0,24	0,30	0,37	0,46	0,56	0,65
	105	85	85		0,30	0,37	0,46	0,58	0,70	0,81
	115	100	100		0,28	0,35	0,44	0,55	0,66	0,77
	80	70	70		0,24	0,29	0,36	0,44	0,53	0,61
	85	75	75		0,25	0,31	0,39	0,49	0,60	0,69
	70	65	65		0,21	0,26	0,33	0,41	0,49	0,56
	70	50	60		0,18	0,21	0,26	0,32	0,38	0,43
	115	100	100		0,28	0,35	0,44	0,55	0,66	0,77
	55	35	35		0,11	0,14	0,18	0,22	0,27	0,31
	140	100	100	100	0,36	0,45	0,55	0,67	0,80	0,91
	185	115	140	140	0,35	0,43	0,52	0,63	0,74	0,84
	115	85	85		0,31	0,38	0,46	0,55	0,64	0,73
	70	45	60		0,17	0,20	0,24	0,28	0,33	0,37
	105	90	90		0,34	0,41	0,49	0,59	0,69	0,78
	90	80	80		0,28	0,34	0,40	0,47	0,55	0,62

Los valores de corte indicados son de referencia.

Los datos óptimos para cada situación de mecanizado deben determinarse mediante ensayos o durante el propio proceso de mecanizado.

Recomendación de valores de corte para brocas escalonadas

Avance y velocidad de corte

MEGA-Step-Drill-Steel-Plus | SCD590, 591

Grupo de arranque de virutas de Mapal*		Material	Rigidez/dureza [N/mm ²] [HRC]
P	P1	P1.1 Aceros de construcción, para tornos automáticos, de cementación y revenidos, no aleados	< 700
		P1.2 Aceros de construcción, para tornos automáticos, de cementación y revenidos, no aleados	< 1200
	P2	P2.1 Aceros nitrurados, de cementación y aceros revenidos, aleados	< 900
		P2.2 Aceros nitrurados, de cementación y aceros revenidos, aleados	< 1400
	P3	P3.1 Aceros para herramientas, rodamientos, resortes y rápidos**	< 800
		P3.2 Aceros para herramientas, rodamientos, resortes y rápidos**	< 1000
		P3.3 Aceros para herramientas, rodamientos, resortes y rápidos**	< 1500
	P4	P4.1 Aceros inoxidables, ferríticos y martensíticos	
	P5	P5.1 Fundición de acero	
	P6	P6.1 Fundición de acero inoxidable, ferrítica y martensítica	
K	K1	K1.1 Hierro fundido con grafito laminar (fundición gris), GJL	< 300
		K2.1 Hierro fundido con grafito esferoidal, GJS	< 500
	K2	K2.2 Hierro fundido con grafito esferoidal, GJS	≤ 800
		K2.3 Hierro fundido con grafito esferoidal, GJS	> 800
	K3	K3.1 Hierro fundido con grafito vermicular, GJV; fundición maleable, GJM	< 500
		K3.2 Hierro fundido con grafito vermicular, GJV; fundición maleable, GJM	> 500
H	H1	H1.1 Acero templado/fundición de acero	< 44
		H1.2 Acero templado/fundición de acero	< 55

* Grupos de mecanizado MAPAL

** Si los componentes de aleación de Cr, Mo, Ni, V, W suman > 8 %, elegir el siguiente grupo de mecanizado MAPAL superior.

	Velocidad de corte v_c [m/min]				Avance f [mm] con diámetro de broca					
	Refrigeración interna	Refrigeración exterior	MMS	Aire	2,50	3,70	5,00	7,45	10,20	15,00
	110	100	100		0,09	0,11	0,14	0,18	0,23	0,29
	100	85	85		0,11	0,14	0,18	0,23	0,29	0,36
	110	95	95		0,10	0,13	0,17	0,22	0,27	0,34
	75	65	65		0,09	0,11	0,14	0,18	0,22	0,27
	85	70	70		0,09	0,11	0,15	0,19	0,25	0,30
	65	60	60		0,08	0,10	0,13	0,16	0,20	0,25
	65	50	55		0,07	0,08	0,10	0,13	0,16	0,19
	65	50	55		0,06	0,08	0,10	0,13	0,16	0,20
	110	95	95		0,10	0,13	0,17	0,22	0,27	0,34
	65	50	55		0,06	0,08	0,10	0,13	0,16	0,20
	120	85	85	85	0,13	0,19	0,26	0,35	0,45	0,54
	160	100	120	120	0,13	0,18	0,25	0,33	0,42	0,50
	100	75	75		0,12	0,16	0,22	0,28	0,36	0,43
	60	40	50		0,09	0,12	0,15	0,19	0,24	0,28
	90	80	80		0,13	0,18	0,23	0,31	0,39	0,46
	80	70	70		0,11	0,15	0,19	0,25	0,31	0,36
	90	90	90		0,08	0,10	0,13	0,16	0,20	0,25
	25	25	25		0,04	0,05	0,07	0,09	0,11	0,14

Los valores de corte indicados son de referencia.

Los datos óptimos para cada situación de mecanizado deben determinarse mediante ensayos o durante el propio proceso de mecanizado.





TALADRADO PROFUNDO

Taladro profundo

MEGA-Pilot-Drill	268
MEGA-Deep-Drill	269
MEGA-Deep-Drill-Alu	278

Anexo técnico

Recomendación de valores de corte	284
Información de aplicación de taladros profundos	742

MEGA-Pilot-Drill

Broca escalonada completa en metal duro
SCD581, con suministro de refrigerante interior

Ejecución:
 Diámetro de broca: 1,00 – 3,00 mm
 Tolerancia del agujero: IT 9 (alcanzable)
 Material de corte: HP246
 Número de insertos: 2
 Número de biseles guía: 2
 Ángulo de la punta: 142°

Aplicación:
 Broca piloto especialmente adaptada a MEGA-Deep-Drill.
 Se puede utilizar como máximo un diámetro de 3,00 mm.

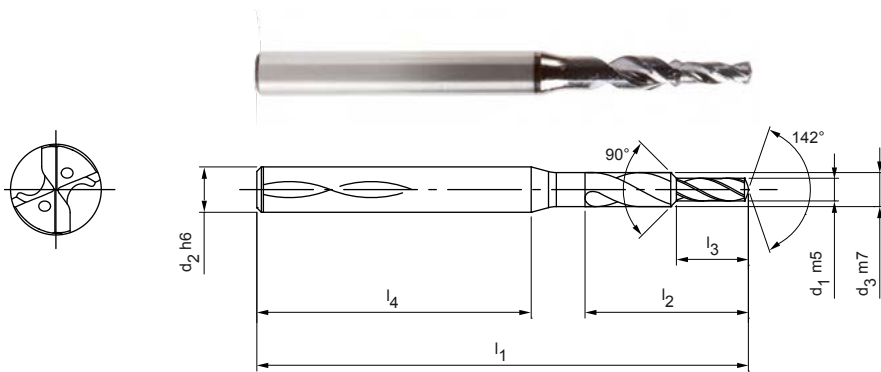

Serie preferente disponible en stock en forma de mango HA

Dimensiones							Forma del mango HA	
d_1 m5	d_2 h6	d_3 m7	l_1	l_2	l_3	l_4	Especificación	Referencia
1,00	3	1,5	50	7,2	3	38	SCD581-0100-2-2-142HA-HP246	31080870
1,10	3	1,65	50	7,9	3,3	37,5	SCD581-0110-2-2-142HA-HP246	31080871
1,20	3	1,8	50	8,6	3,6	36,9	SCD581-0120-2-2-142HA-HP246	31080872
1,30	3	1,95	50	9,4	3,9	36,3	SCD581-0130-2-2-142HA-HP246	31080873
1,40	3	2,1	50	10,1	4,2	35,7	SCD581-0140-2-2-142HA-HP246	31080874
1,50	3	2,25	50	10,8	4,5	35,1	SCD581-0150-2-2-142HA-HP246	31080875
1,60	3	2,4	50	11,5	4,8	34,6	SCD581-0160-2-2-142HA-HP246	31080876
1,70	3	2,55	50	12,2	5,1	34	SCD581-0170-2-2-142HA-HP246	31080877
1,80	3	2,7	50	13	5,4	33,4	SCD581-0180-2-2-142HA-HP246	31080878
1,90	4	2,85	55	13,7	5,7	35,9	SCD581-0190-2-2-142HA-HP246	31080879
2,00	4	3	55	14,4	6	35,3	SCD581-0200-2-2-142HA-HP246	31080880
2,10	4	3,15	55	15,1	6,3	34,8	SCD581-0210-2-2-142HA-HP246	31080881
2,20	4	3,3	55	15,8	6,6	34,2	SCD581-0220-2-2-142HA-HP246	31080882
2,30	4	3,45	55	16,6	6,9	33,6	SCD581-0230-2-2-142HA-HP246	31080883
2,40	4	3,6	55	17,3	7,2	33	SCD581-0240-2-2-142HA-HP246	31080884
2,50	4	3,75	55	18	7,5	32,4	SCD581-0250-2-2-142HA-HP246	31080885
2,60	6	3,9	66	18,7	7,8	39,1	SCD581-0260-2-2-142HA-HP246	31080886
2,70	6	4,05	66	19,4	8,1	38,5	SCD581-0270-2-2-142HA-HP246	31080887
2,80	6	4,2	66	20,2	8,4	37,9	SCD581-0280-2-2-142HA-HP246	31080888
2,90	6	4,35	66	20,9	8,7	37,4	SCD581-0290-2-2-142HA-HP246	31080889
3,00	6	4,5	66	21,6	9	36,8	SCD581-0300-2-2-142HA-HP246	31080890

Medidas en mm.

Para la recomendación de valores de corte, véase al final del capítulo.
 Ejecuciones especiales y otros recubrimientos a petición.

MEGA-Deep-Drill

Broca helicoidal de metal duro
SCD171 (20xD), con suministro de refrigerante interior

Ejecución:

Diámetro de broca: 1,00 – 2,99 mm
Tolerancia del agujero: \geq IT 9
Material de corte: HP246
Número de insertos: 2
Número de bisel guía: 4
Ángulo de la punta: 135°
Ángulo de hélice: 30°
Particularidades: Recubrimiento del cabezal

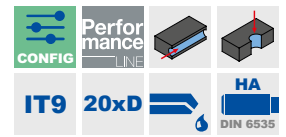
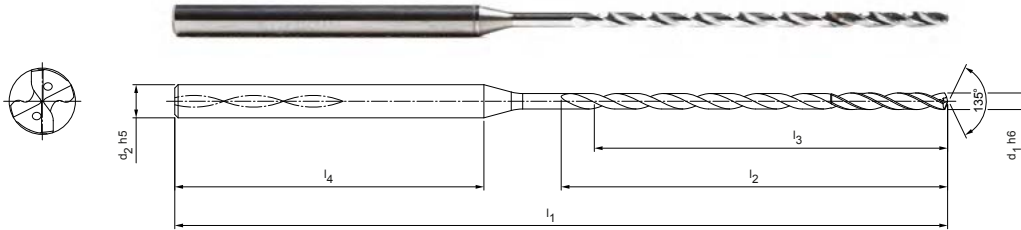

Serie preferente disponible en stock en forma de mango HA

Dimensiones						Proporción L/d	Forma del mango HA	
d ₁ h6	d ₂ h5	l ₁	l ₂	l ₃	l ₄		Especificación	Referencia
1,00	3	62	27	25	28	28	SCD171-0100-2-4-135HA20-HP246	30998795
1,10	3	62	27	25	28	28	SCD171-0110-2-4-135HA20-HP246	30998796
1,20	3	62	27	25	28	28	SCD171-0120-2-4-135HA20-HP246	30998798
1,30	3	70	35	33	28	28	SCD171-0130-2-4-135HA20-HP246	30998799
1,40	3	70	35	32	28	28	SCD171-0140-2-4-135HA20-HP246	30998800
1,50	3	70	35	32	28	28	SCD171-0150-2-4-135HA20-HP246	30998801
1,60	3	75	41	38	28	28	SCD171-0160-2-4-135HA20-HP246	30998802
1,70	3	75	41	38	28	28	SCD171-0170-2-4-135HA20-HP246	30998803
1,80	3	75	41	38	28	28	SCD171-0180-2-4-135HA20-HP246	30998804
1,90	3	80	46	43	28	28	SCD171-0190-2-4-135HA20-HP246	30998805
2,00	3	80	46	43	28	28	SCD171-0200-2-4-135HA20-HP246	30998806
2,10	3	80	46	42	28	28	SCD171-0210-2-4-135HA20-HP246	30998807
2,20	3	90	55	51	28	28	SCD171-0220-2-4-135HA20-HP246	30998808
2,30	3	90	55	51	28	28	SCD171-0230-2-4-135HA20-HP246	30998809
2,40	3	90	55	51	28	28	SCD171-0240-2-4-135HA20-HP246	30998810
2,50	3	90	55	51	28	28	SCD171-0250-2-4-135HA20-HP246	30998811
2,60	3	100	66	62	28	28	SCD171-0260-2-4-135HA20-HP246	30998812
2,70	3	100	66	61	28	28	SCD171-0270-2-4-135HA20-HP246	30998813
2,80	3	100	66	61	28	28	SCD171-0280-2-4-135HA20-HP246	30998814
2,90	3	100	66	61	28	28	SCD171-0290-2-4-135HA20-HP246	30998815

Continúa en la página siguiente.

Recomendación de broca piloto:

Utilice como broca piloto la MEGA-Pilot-Drill (SCD581) o la MICRO-Drill-Steel (SCD371 – 5xD) con el mismo diámetro nominal.

La punta de ángulo y las tolerancias diametrales están adaptadas para funcionar lo mejor posible y para la combinación de la broca piloto y el taladro profundo.

MEGA-Deep-Drill | Broca helicoidal de metal duro SCD171 (20xD), con suministro de refrigerante interior

Características configurables

**Diámetro:**

Diámetro seleccionable libremente en incrementos de 0,01 mm

**Especificación**

SCD171-[diámetro]-2-4-135HA20-HP246

Ejemplo:

SCD171-0221-2-4-135HA20-HP246

Diámetro de la herramienta $d_1 = 2,21$ mm

Dimensiones de la serie configurable

d_1 mín.	d_1 máx.	d_2 h6	l_1	l_2	l_3	l_4
1,00	1,29	3	62	27	25	28
1,30	1,39	3	70	35	33	28
1,40	1,59	3	70	35	32	28
1,60	1,89	3	75	41	38	28
1,90	2,09	3	80	46	43	28
2,10	2,19	3	80	46	42	28
2,20	2,59	3	90	55	51	28
2,60	2,69	3	100	66	62	28
2,70	2,99	3	100	66	61	28

Encontrará información técnica de aplicación para el taladrado profundo en el capítulo «Anexo técnico».

Medidas en mm.

Para la recomendación de valores de corte, véase al final del capítulo.

Ejecuciones especiales y otros recubrimientos a petición.

MEGA-Deep-Drill

Broca helicoidal de metal duro
SCD171 (30xD), con suministro de refrigerante interior

Ejecución:

Diámetro de broca: 1,00 – 2,99 mm
Tolerancia del agujero: \geq IT 9
Material de corte: HP246
Número de insertos: 2
Número de bisel guía: 4
Ángulo de la punta: 135°
Ángulo de hélice: 30°
Particularidades: Recubrimiento del cabezal

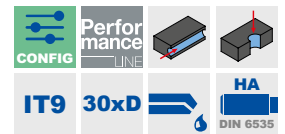
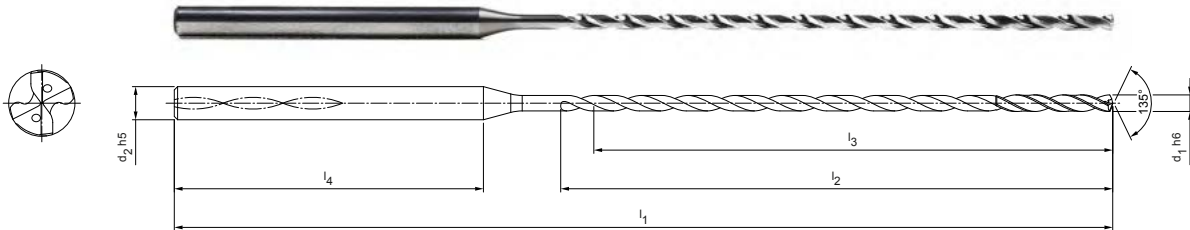

Serie preferente disponible en stock en forma de mango HA

Dimensiones						Proporción L/d	Forma del mango HA	
d ₁ h6	d ₂ h5	l ₁	l ₂	l ₃	l ₄		Especificación	Referencia
1,00	3	75	38	36	28	36	SCD171-0100-2-4-135HA30-HP246	30998816
1,10	3	75	38	36	28	33	SCD171-0110-2-4-135HA30-HP246	30998817
1,20	3	75	38	36	28	30	SCD171-0120-2-4-135HA30-HP246	30998818
1,30	3	85	50	48	28	37	SCD171-0130-2-4-135HA30-HP246	30998819
1,40	3	85	50	47	28	34	SCD171-0140-2-4-135HA30-HP246	30998820
1,50	3	85	50	47	28	31	SCD171-0150-2-4-135HA30-HP246	30998821
1,60	3	95	59	56	28	35	SCD171-0160-2-4-135HA30-HP246	30998822
1,70	3	95	59	56	28	33	SCD171-0170-2-4-135HA30-HP246	30998823
1,80	3	95	59	56	28	31	SCD171-0180-2-4-135HA30-HP246	30998824
1,90	3	100	66	63	28	33	SCD171-0190-2-4-135HA30-HP246	30998825
2,00	3	100	66	63	28	32	SCD171-0200-2-4-135HA30-HP246	30998826
2,10	3	100	66	62	28	30	SCD171-0210-2-4-135HA30-HP246	30998827
2,20	3	115	80	76	28	35	SCD171-0220-2-4-135HA30-HP246	30998828
2,30	3	115	80	76	28	33	SCD171-0230-2-4-135HA30-HP246	30998829
2,40	3	115	80	76	28	32	SCD171-0240-2-4-135HA30-HP246	30998830
2,50	3	115	80	76	28	30	SCD171-0250-2-4-135HA30-HP245	30451572
2,60	3	130	96	92	28	35	SCD171-0260-2-4-135HA30-HP246	30998832
2,70	3	130	96	91	28	34	SCD171-0270-2-4-135HA30-HP246	30998833
2,80	3	130	96	91	28	33	SCD171-0280-2-4-135HA30-HP246	30998834
2,90	3	130	96	91	28	31	SCD171-0290-2-4-135HA30-HP246	30998835

Continúa en la página siguiente.

Recomendación de broca piloto:

Utilice como broca piloto la MEGA-Pilot-Drill (SCD581) o la MICRO-Drill-Steel (SCD371 – 5xD) con el mismo diámetro nominal.

La punta de ángulo y las tolerancias diametrales están adaptadas para funcionar lo mejor posible y para la combinación de la broca piloto y el taladro profundo.

MEGA-Deep-Drill | Broca helicoidal de metal duro SCD171 (20xD), con suministro de refrigerante interior

Características configurables

**Diámetro:**

Diámetro seleccionable libremente en incrementos de 0,01 mm

**Especificación**

SCD171-[diámetro]-2-4-135HA30-HP246

Ejemplo:

SCD171-0221-2-4-135HA30-HP246

Diámetro de la herramienta $d_1 = 2,21$ mm

Dimensiones de la serie configurable

d_1 mín.	d_1 máx.	d_2 h6	l_1	l_2	l_3	l_4
1,00	1,29	3	75	38	36	28
1,30	1,39	3	85	50	48	28
1,40	1,59	3	85	50	47	28
1,60	1,89	3	95	59	56	28
1,90	2,09	3	100	66	63	28
2,10	2,19	3	100	66	62	28
2,20	2,59	3	115	80	76	28
2,60	2,69	3	130	96	92	28
2,70	2,99	3	130	96	91	28

Encontrará información técnica de aplicación para el taladrado profundo en el capítulo «Anexo técnico».

Medidas en mm.

Para la recomendación de valores de corte, véase al final del capítulo.

Ejecuciones especiales y otros recubrimientos a petición.

MEGA-Deep-Drill

Broca helicoidal de metal duro
SCD171 (15xD), con suministro de refrigerante interior

Ejecución:

Diámetro de broca: 3,00 - 15,00 mm
Tolerancia del agujero: \geq IT 9
Material de corte: HP285 / HP245
Número de insertos: 2
Número de biseles guía: 4
Ángulo de la punta: 135°
Ángulo de hélice: 30°

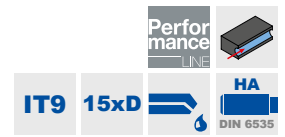
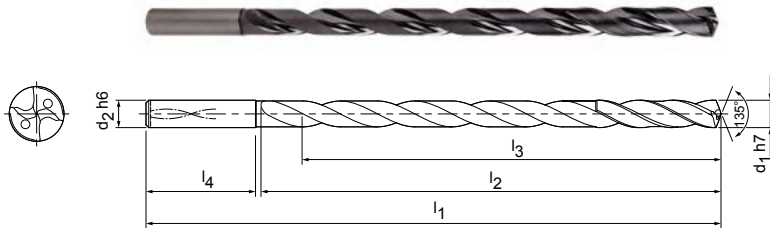

Serie preferente disponible en stock en forma de mango HA

Dimensiones						Proporción L/d	Forma del mango HA	
d ₁ h7	d ₂ h6	l ₁	l ₂	l ₃	l ₄		Especificación	Referencia
3,00	4	90	56	52	32	17	SCD171-0300-2-4-135HA15-HP285	30392214
3,50	4	100	66	61	32	17	SCD171-0350-2-4-135HA15-HP285	30392215
4,00	4	100	66	60	32	15	SCD171-0400-2-4-135HA15-HP285	30392216
4,50	5	110	74	67	34	15	SCD171-0450-2-4-135HA15-HP285	30392217
5,00	5	120	84	77	34	15	SCD171-0500-2-4-135HA15-HP285	30392218
5,50	6	130	92	84	36	15	SCD171-0550-2-4-135HA15-HP285	30392219
6,00	6	140	102	93	36	16	SCD171-0600-2-4-135HA15-HP285	30392220
7,00	7	155	115	105	38	15	SCD171-0700-2-4-135HA15-HP285	30392221
8,00	8	175	133	121	40	15	SCD171-0800-2-4-135HA15-HP285	30392222
9,00	9	190	148	135	40	15	SCD171-0900-2-4-135HA15-HP285	30392223
9,50	10	210	168	153	40	15	SCD171-0950-2-4-135HA15-HP245	30453021
10,00	10	210	168	153	40	15	SCD171-1000-2-4-135HA15-HP285	30392224
11,00	11	230	183	167	45	15	SCD171-1100-2-4-135HA15-HP245	30392225
12,00	12	250	203	185	45	15	SCD171-1200-2-4-135HA15-HP245	30392226
13,00	13	265	218	199	45	15	SCD171-1300-2-4-135HA15-HP245	30392227
14,00	14	285	233	212	50	15	SCD171-1400-2-4-135HA15-HP245	30392228
15,00	15	305	253	231	50	15	SCD171-1500-2-4-135HA15-HP245	30392229

Recomendación de broca piloto:

Utilice como broca piloto la MEGA-Drill-Steel-Plus (SCD601 - 3xD) con el mismo diámetro nominal. La punta de ángulo y las tolerancias diametrales están adaptadas para funcionar lo mejor posible y para la combinación de la broca piloto y el taladro profundo.

Encontrará información técnica de aplicación para el taladrado profundo en el capítulo «Anexo técnico».

Medidas en mm.

Para la recomendación de valores de corte, véase al final del capítulo. Ejecuciones especiales y otros recubrimientos a petición.

MEGA-Deep-Drill

Broca helicoidal de metal duro
SCD171 (20xD), con suministro de refrigerante interior

Ejecución:
 Diámetro de broca: 3,00 – 16,00 mm
 Tolerancia del agujero: ≥ IT 9
 Material de corte: HP245 / HP285
 Número de insertos: 2
 Número de biseles guía: 4
 Ángulo de la punta: 135°
 Ángulo de hélice: 30°

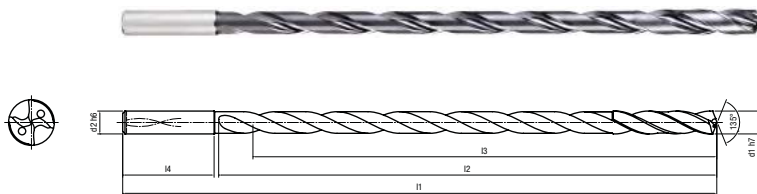

Serie preferente disponible en stock en forma de mango HA

Dimensiones						Proporción L/d	Forma del mango HA	
d ₁ h7	d ₂ h6	l ₁	l ₂	l ₃	l ₄		Especificación	Referencia
3,00	4	110	74	70	32	23	SCD171-0300-2-4-135HA20-HP285	30392231
3,50	4	120	86	81	32	23	SCD171-0350-2-4-135HA20-HP285	30392232
4,00	4	120	86	80	32	20	SCD171-0400-2-4-135HA20-HP285	30392233
5,00	5	145	109	102	34	20	SCD171-0500-2-4-135HA20-HP285	30392235
5,50	6	160	120	112	36	20	SCD171-0550-2-4-135HA20-HP285	30392236
6,00	6	170	130	121	36	20	SCD171-0600-2-4-135HA20-HP285	30392237
6,50	7	190	150	140	36	20	SCD171-0650-2-4-135HA20-HP245	30451508
7,00	7	190	150	140	38	20	SCD171-0700-2-4-135HA20-HP285	30392238
8,00	8	215	173	161	40	20	SCD171-0800-2-4-135HA20-HP285	30392239
9,00	9	240	196	183	40	20	SCD171-0900-2-4-135HA20-HP285	30392240
10,00	10	260	218	203	40	20	SCD171-1000-2-4-135HA20-HP285	30392241
11,00	11	285	238	222	45	20	SCD171-1100-2-4-135HA20-HP245	30392242
12,00	12	305	258	240	45	20	SCD171-1200-2-4-135HA20-HP245	30392243
14,00	14	355	303	282	50	20	SCD171-1400-2-4-135HA20-HP245	30392245
15,00	15	375	323	301	50	20	SCD171-1500-2-4-135HA20-HP245	30392246
16,00	16	400	348	324	50	20	SCD171-1600-2-4-135HA20-HP245	30392247

Recomendación de broca piloto:

Utilice como broca piloto la MEGA-Drill-Steel-Plus (SCD601 – 3xD) con el mismo diámetro nominal.

La punta de ángulo y las tolerancias diametrales están adaptadas para funcionar lo mejor posible y para la combinación de la broca piloto y el taladro profundo.

Encontrará información técnica de aplicación para el taladrado profundo en el capítulo «Anexo técnico».

Medidas en mm.
 Para la recomendación de valores de corte, véase al final del capítulo.
 Ejecuciones especiales y otros recubrimientos a petición.

MEGA-Deep-Drill

Broca helicoidal de metal duro
SCD171 (25xD), con suministro de refrigerante interior

Ejecución:

Diámetro de broca:	3,00 – 14,00 mm
Tolerancia del agujero:	≥ IT 9
Material de corte:	HP285 / HP245
Número de insertos:	2
Número de bisel guía:	4
Ángulo de la punta:	135°
Ángulo de hélice:	30°

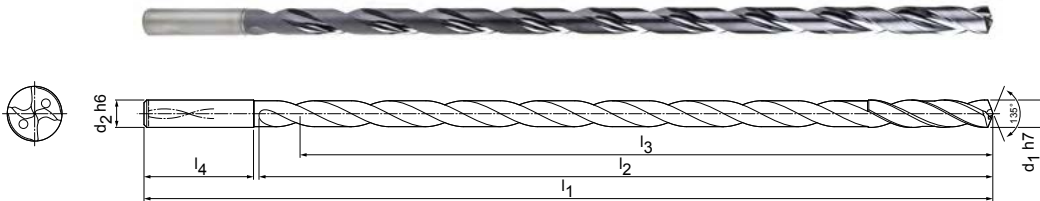

Serie preferente disponible en stock en forma de mango HA

Dimensiones						Proporción L/d	Forma del mango HA	
d ₁ h7	d ₂ h6	l ₁	l ₂	l ₃	l ₄		Especificación	Referencia
3,00	4	125	91	87	32	29	SCD171-0300-2-4-135HA25-HP285	30392248
3,50	4	140	106	101	32	29	SCD171-0350-2-4-135HA25-HP285	30392249
4,00	4	140	106	100	32	25	SCD171-0400-2-4-135HA25-HP285	30392250
5,00	5	170	134	127	34	25	SCD171-0500-2-4-135HA25-HP285	30392252
5,50	6	185	147	139	36	25	SCD171-0550-2-4-135HA25-HP285	30392253
6,00	6	200	160	151	36	25	SCD171-0600-2-4-135HA25-HP285	30392254
7,00	7	225	185	175	38	25	SCD171-0700-2-4-135HA25-HP285	30392255
8,00	8	255	213	201	40	25	SCD171-0800-2-4-135HA25-HP285	30392256
9,00	9	280	238	225	40	25	SCD171-0900-2-4-135HA25-HP285	30392257
10,00	10	310	268	253	40	25	SCD171-1000-2-4-135HA25-HP285	30392258
11,00	11	340	293	277	45	25	SCD171-1100-2-4-135HA25-HP245	30392259
12,00	12	365	318	300	45	25	SCD171-1200-2-4-135HA25-HP245	30392260
14,00	14	425	373	352	50	25	SCD171-1400-2-4-135HA25-HP245	30392262

Recomendación de broca piloto:

Utilice como broca piloto la MEGA-Drill-Steel-Plus (SCD601 – 3xD) con el mismo diámetro nominal.

La punta de ángulo y las tolerancias diametrales están adaptadas para funcionar lo mejor posible y para la combinación de la broca piloto y el taladro profundo.

Encontrará información técnica de aplicación para el taladrado profundo en el capítulo «Anexo técnico».

Medidas en mm.

Para la recomendación de valores de corte, véase al final del capítulo.

Ejecuciones especiales y otros recubrimientos a petición.

MEGA-Deep-Drill

Broca helicoidal de metal duro

SCD171 (30xD), con suministro de refrigerante interior

Ejecución:

Diámetro de broca:	3,00 – 12,00 mm
Tolerancia del agujero:	≥ IT 9
Material de corte:	HP245 / HP285
Número de insertos:	2
Número de biseles guía:	4
Ángulo de la punta:	135°
Ángulo de hélice:	30°

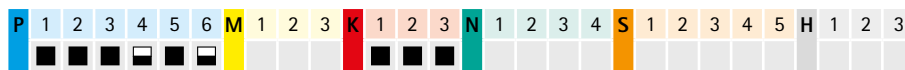
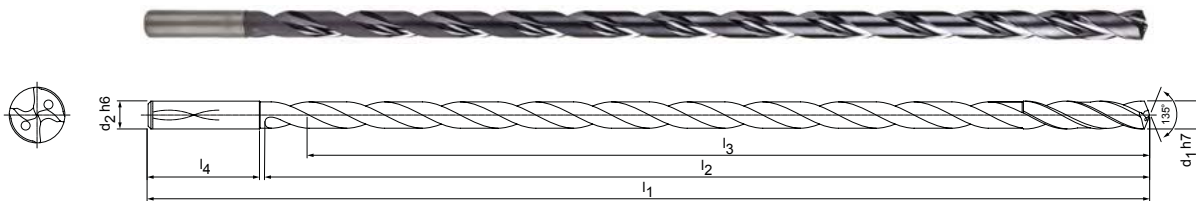

Serie preferente disponible en stock en forma de mango HA

Dimensiones						Proporción L/d	Forma del mango HA	
d ₁ h7	d ₂ h6	l ₁	l ₂	l ₃	l ₄		Especificación	Referencia
3,00	4	145	110	106	32	35	SCD171-0300-2-4-135HA30-HP285	30392264
4,00	4	160	126	120	32	30	SCD171-0400-2-4-135HA30-HP285	30392266
4,50	5	180	144	137	34	31	SCD171-0450-2-4-135HA30-HP285	30392267
5,00	5	195	159	152	34	30	SCD171-0500-2-4-135HA30-HP285	30392268
5,50	6	210	172	164	36	30	SCD171-0550-2-4-135HA30-HP285	30392269
6,00	6	230	192	183	36	31	SCD171-0600-2-4-135HA30-HP285	30392270
7,00	7	260	220	210	38	30	SCD171-0700-2-4-135HA30-HP285	30392271
8,00	8	295	253	241	40	30	SCD171-0800-2-4-135HA30-HP285	30392272
9,00	9	325	283	270	40	30	SCD171-0900-2-4-135HA30-HP285	30392273
10,00	10	360	318	303	40	30	SCD171-1000-2-4-135HA30-HP285	30392274
11,00	11	400	353	337	45	31	SCD171-1100-2-4-135HA30-HP245	30392275
12,00	12	430	383	365	45	30	SCD171-1200-2-4-135HA30-HP245	30392276

Recomendación de broca piloto:

Utilice como broca piloto la MEGA-Drill-Steel-Plus (SCD601 – 3xD) con el mismo diámetro nominal.

La punta de ángulo y las tolerancias diametrales están adaptadas para funcionar lo mejor posible y para la combinación de la broca piloto y el taladro profundo.

Encontrará información técnica de aplicación para el taladrado profundo en el capítulo «Anexo técnico».

Medidas en mm.

Para la recomendación de valores de corte, véase al final del capítulo.

Ejecuciones especiales y otros recubrimientos a petición.

MEGA-Deep-Drill

Broca helicoidal de metal duro
SCD171 (40xD), con suministro de refrigerante interior

Ejecución:

Diámetro de broca:	4,00 – 6,00 mm
Tolerancia del agujero:	≥ IT 9
Material de corte:	HP285
Número de insertos:	2
Número de biseles guía:	4
Ángulo de la punta:	130 °
Ángulo de hélice:	30°

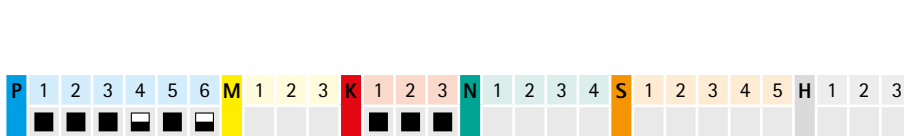
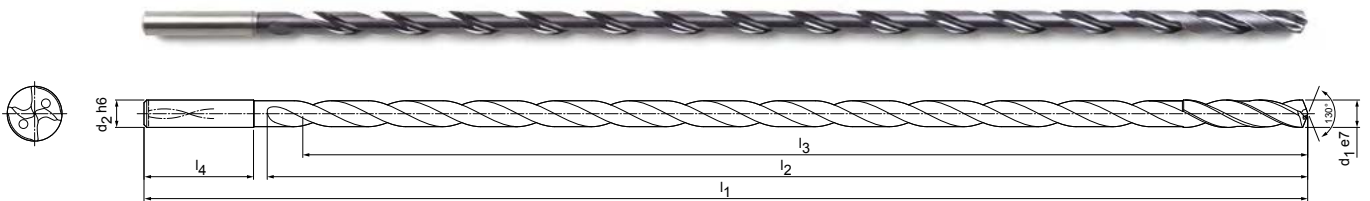

Serie preferente disponible en stock en forma de mango HA

Dimensiones						Proporción L/d	Forma del mango HA	
d ₁ e7	d ₂ h6	l ₁	l ₂	l ₃	l ₄		Especificación	Referencia
4,00	4	205	170	164	32	43	SCD171-0400-2-4-130HA40-HP285	30549867
5,00	5	245	208	201	34	42	SCD171-0500-2-4-130HA40-HP285	30549869
6,00	6	290	250	241	36	42	SCD171-0600-2-4-130HA40-HP285	30549871

Recomendación para broca piloto o para pretaladrar:

Utilice como broca piloto la MEGA-Drill-Steel-Plus (SCD601 – 3xD) con el mismo diámetro nominal. A continuación, pretaladrar con la MEGA-Deep-Drill (SCD171 – 20xD) y también con el mismo diámetro nominal. La punta de ángulo y la tolerancia diametral están adaptadas para obtener una óptima funcionalidad y para la combinación de la broca piloto y el taladro profundo.

Encontrará información técnica de aplicación para el taladrado profundo en el capítulo «Anexo técnico».

Medidas en mm.

Para la recomendación de valores de corte, véase al final del capítulo.
Ejecuciones especiales y otros recubrimientos a petición.

MEGA-Deep-Drill-Alu

Broca helicoidal de metal duro
SCD181 (15xD), con suministro de refrigerante interior

Ejecución:

Diámetro de broca: 3,00 – 12,00 mm
Tolerancia del agujero: ≥ IT 9
Material de corte: HU680 / HU644
Número de insertos: 2
Número de biseles guía: 4
Ángulo de la punta: 135°
Ángulo de hélice: 30°

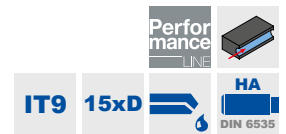
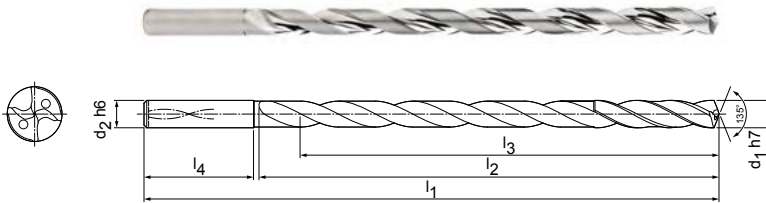

Serie preferente disponible en stock en forma de mango HA

Dimensiones						Proporción L/d	Forma del mango HA	
d ₁ h7	d ₂ h6	l ₁	l ₂	l ₃	l ₄		Especificación	Referencia
3,00	4	90	56	52	32	17	SCD181-0300-2-4-135HA15-HU680	30392277
3,50	4	100	66	61	32	17	SCD181-0350-2-4-135HA15-HU680	30392278
4,00	4	100	66	60	32	15	SCD181-0400-2-4-135HA15-HU680	30392279
5,00	5	120	84	77	34	15	SCD181-0500-2-4-135HA15-HU680	30392281
6,00	6	140	102	93	36	16	SCD181-0600-2-4-135HA15-HU680	30392283
7,00	7	155	115	105	38	15	SCD181-0700-2-4-135HA15-HU680	30392284
8,00	8	175	133	121	40	15	SCD181-0800-2-4-135HA15-HU680	30392285
10,00	10	210	168	153	40	15	SCD181-1000-2-4-135HA15-HU680	30392287
12,00	12	250	203	185	45	15	SCD181-1200-2-4-135HA15-HU644	30392289

Recomendación de broca piloto:

Utilice como broca piloto la MEGA-Drill-Alu (SCD131 – 3xD/5xD) con el mismo diámetro nominal. La punta de ángulo y las tolerancias diametrales están adaptadas para funcionar lo mejor posible y para la combinación de la broca piloto y el taladro profundo.

Encontrará información técnica de aplicación para el taladrado profundo en el capítulo «Anexo técnico».

Medidas en mm.
Para la recomendación de valores de corte, véase al final del capítulo.
Ejecuciones especiales y otros recubrimientos a petición.

MEGA-Deep-Drill-Alu

Broca helicoidal de metal duro
SCD181 (20xD), con suministro de refrigerante interior

Ejecución:

Diámetro de broca:	3,00 – 12,00 mm
Tolerancia del agujero:	≥ IT 9
Material de corte:	HU680 / HU644
Número de insertos:	2
Número de biseles guía:	4
Ángulo de la punta:	135°
Ángulo de hélice:	30°

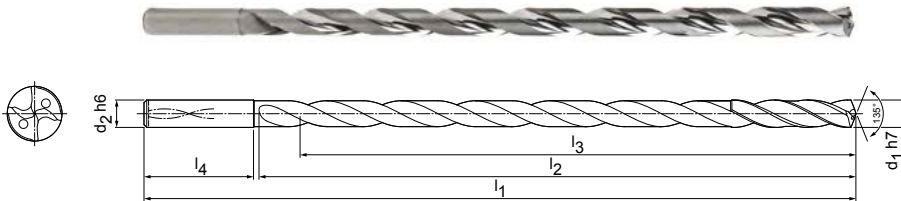

Serie preferente disponible en stock en forma de mango HA

Dimensiones						Proporción L/d	Forma del mango HA	
d ₁ h7	d ₂ h6	l ₁	l ₂	l ₃	l ₄		Especificación	Referencia
3,00	4	110	74	70	32	23	SCD181-0300-2-4-135HA20-HU680	30392294
4,00	4	120	86	80	32	20	SCD181-0400-2-4-135HA20-HU680	30392296
5,00	5	145	109	102	34	20	SCD181-0500-2-4-135HA20-HU680	30392298
5,50	6	160	120	112	36	20	SCD181-0550-2-4-135HA20-HU680	30392299
6,00	6	170	130	121	36	20	SCD181-0600-2-4-135HA20-HU680	30392300
7,00	7	190	150	140	38	20	SCD181-0700-2-4-135HA20-HU680	30392301
8,00	8	215	173	161	40	20	SCD181-0800-2-4-135HA20-HU680	30392302
10,00	10	260	218	203	40	20	SCD181-1000-2-4-135HA20-HU680	30392304
12,00	12	305	258	240	45	20	SCD181-1200-2-4-135HA20-HU644	30392306

Recomendación de broca piloto:

Utilice como broca piloto la MEGA-Drill-Alu (SCD131 – 3xD/5xD) con el mismo diámetro nominal. La punta de ángulo y las tolerancias diametrales están adaptadas para funcionar lo mejor posible y para la combinación de la broca piloto y el taladro profundo.

Encontrará información técnica de aplicación para el taladrado profundo en el capítulo «Anexo técnico».

Medidas en mm.

Para la recomendación de valores de corte, véase al final del capítulo.
Ejecuciones especiales y otros recubrimientos a petición.

MEGA-Deep-Drill-Alu

Broca helicoidal de metal duro

SCD181 (25xD), con suministro de refrigerante interior

Ejecución:

Diámetro de broca:	3,00 – 10,00 mm
Tolerancia del agujero:	≥ IT 9
Material de corte:	HU680
Número de insertos:	2
Número de bisel guía:	4
Ángulo de la punta:	135°
Ángulo de hélice:	30°

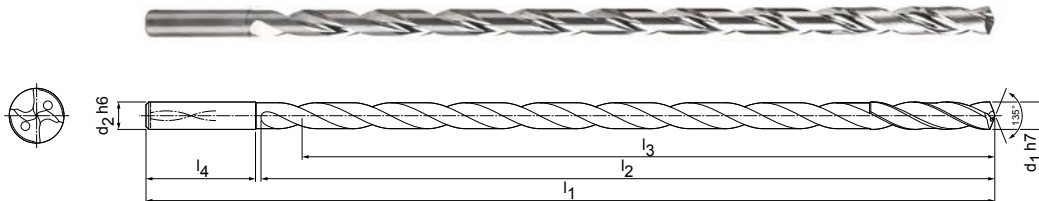

Serie preferente disponible en stock en forma de mango HA

Dimensiones						Proporción L/d	Forma del mango HA	
d ₁ h7	d ₂ h6	l ₁	l ₂	l ₃	l ₄		Especificación	Referencia
3,00	4	125	91	87	32	29	SCD181-0300-2-4-135HA25-HU680	30392311
4,00	4	140	106	100	32	25	SCD181-0400-2-4-135HA25-HU680	30392313
5,00	5	170	134	127	34	25	SCD181-0500-2-4-135HA25-HU680	30392315
6,00	6	200	160	151	36	25	SCD181-0600-2-4-135HA25-HU680	30392317
7,00	7	225	185	175	38	25	SCD181-0700-2-4-135HA25-HU680	30392318
8,00	8	255	213	201	40	25	SCD181-0800-2-4-135HA25-HU680	30392319
10,00	10	310	268	253	40	25	SCD181-1000-2-4-135HA25-HU680	30392321

Recomendación de broca piloto:

Utilice como broca piloto la MEGA-Drill-Alu (SCD131 – 3xD/5xD) con el mismo diámetro nominal.

La punta de ángulo y las tolerancias diametrales están adaptadas para funcionar lo mejor posible y para la combinación de la broca piloto y el taladro profundo.

Encontrará información técnica de aplicación para el taladrado profundo en el capítulo «Anexo técnico».

Medidas en mm.

Para la recomendación de valores de corte, véase al final del capítulo.

Ejecuciones especiales y otros recubrimientos a petición.

MEGA-Deep-Drill-Alu

Broca helicoidal de metal duro
SCD181 (30xD), con suministro de refrigerante interior

Ejecución:

Diámetro de broca:	4,00 - 6,00 mm
Tolerancia del agujero:	≥ IT 9
Material de corte:	HU680
Número de insertos:	2
Número de biseles guía:	4
Ángulo de la punta:	135°
Ángulo de hélice:	30°

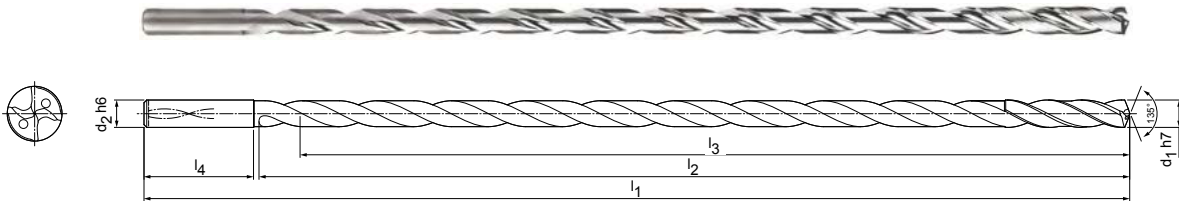

Serie preferente disponible en stock en forma de mango HA

Dimensiones						Proporción L/d	Forma del mango HA	
d ₁ h7	d ₂ h6	l ₁	l ₂	l ₃	l ₄		Especificación	Referencia
4,00	4	160	126	120	32	30	SCD181-0400-2-4-135HA30-HU680	30392328
4,50	5	180	144	137	34	31	SCD181-0450-2-4-135HA30-HU680	30392329
5,00	5	195	159	152	34	30	SCD181-0500-2-4-135HA30-HU680	30392330
6,00	6	230	192	183	36	31	SCD181-0600-2-4-135HA30-HU680	30392332

Recomendación de broca piloto:

Utilice como broca piloto la MEGA-Drill-Alu (SCD131 - 3xD/5xD) con el mismo diámetro nominal. La punta de ángulo y las tolerancias diametrales están adaptadas para funcionar lo mejor posible y para la combinación de la broca piloto y el taladro profundo.

Encontrará información técnica de aplicación para el taladrado profundo en el capítulo «Anexo técnico».

Medidas en mm.

Para la recomendación de valores de corte, véase al final del capítulo.
Ejecuciones especiales y otros recubrimientos a petición.



MEGA-Deep-Drill-Alu

Broca helicoidal de metal duro
SCD181 (40xD), con suministro de refrigerante interior

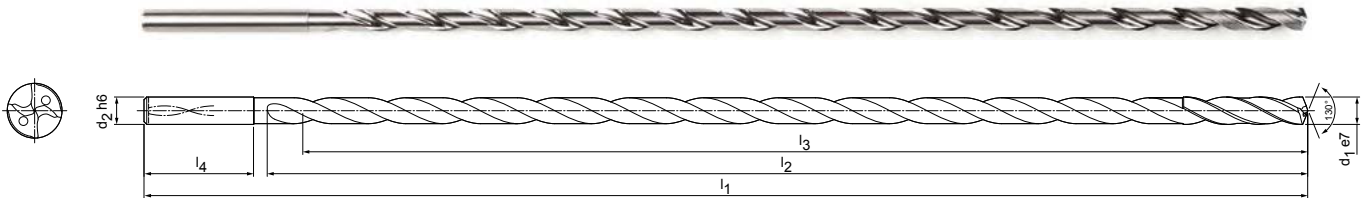
Ejecución:
 Diámetro de broca: 6,00 - 7,00 mm
 Tolerancia del agujero: \geq IT 9
 Material de corte: HU680
 Número de insertos: 2
 Número de biseles guía: 4
 Ángulo de la punta: 130 °
 Ángulo de hélice: 30°



P 1 2 3 4 5 6 M 1 2 3 K 1 2 3 N 1 2 3 4 S 1 2 3 4 5 H 1 2 3

Serie preferente disponible en stock en forma de mango HA

Dimensiones						Proporción L/d	Forma del mango HA	
d ₁ h7	d ₂ h6	l ₁	l ₂	l ₃	l ₄		Especificación	Referencia
6,00	6	290	250	241	36	42	SCD181-0600-2-4-130HA40-HU680	30549881
7,00	7	330	290	280	38	41	SCD181-0700-2-4-130HA40-HU680	30549882

Recomendación de broca piloto:

Utilice como broca piloto la MEGA-Drill-Alu (SCD131 - 3xD/5xD) con el mismo diámetro nominal. La punta de ángulo y las tolerancias diametrales están adaptadas para funcionar lo mejor posible y para la combinación de la broca piloto y el taladro profundo.

Encontrará información técnica de aplicación para el taladrado profundo en el capítulo «Anexo técnico».

Medidas en mm.
 Para la recomendación de valores de corte, véase al final del capítulo.
 Ejecuciones especiales y otros recubrimientos a petición.



Recomendación de valores de corte para taladro profundo

Avance y velocidad de corte

MEGA-Pilot-Drill | SCD581

Grupo de arranque de virutas de Mapal*		Material	Rigidez/dureza [N/mm ²] [HRC]
P	P1	P1.1 Aceros de construcción, para tornos automáticos, de cementación y revenidos, no aleados	< 700
		P1.2 Aceros de construcción, para tornos automáticos, de cementación y revenidos, no aleados	< 1200
	P2	P2.1 Aceros nitrurados, de cementación y aceros revenidos, aleados	< 900
		P2.2 Aceros nitrurados, de cementación y aceros revenidos, aleados	< 1400
	P3	P3.1 Aceros para herramientas, rodamientos, resortes y rápidos**	< 800
		P3.2 Aceros para herramientas, rodamientos, resortes y rápidos**	< 1000
		P3.3 Aceros para herramientas, rodamientos, resortes y rápidos**	< 1500
	P5	P5.1 Fundición de acero	
M	M1	M1.1 Aceros inoxidable, austeníticos	< 700
		M1.2 Aceros inoxidable, ferríticos/austeníticos (dúplex)	< 1000
K	K1	K1.1 Hierro fundido con grafito laminar (fundición gris), GJL	< 300
		K2.1 Hierro fundido con grafito esferoidal, GJS	< 500
	K2	K2.2 Hierro fundido con grafito esferoidal, GJS	≤ 800
		K2.3 Hierro fundido con grafito esferoidal, GJS	> 800
	K3	K3.1 Hierro fundido con grafito vermicular, GJV; fundición maleable, GJM	< 500
		K3.2 Hierro fundido con grafito vermicular, GJV; fundición maleable, GJM	> 500

* Grupos de mecanizado MAPAL

** Si los componentes de aleación de Cr, Mo, Ni, V, W suman > 8 %, elegir el siguiente grupo de mecanizado MAPAL superior.

	Velocidad de corte v_c [m/min]				Avance f [mm] con diámetro de broca					
	Refrigeración interna	Refrigeración exterior	MMS	Aire	1,00	1,20	1,60	1,90	2,40	3,00
	80	70	70		0,05	0,06	0,06	0,07	0,08	0,09
	70	60	60		0,07	0,07	0,08	0,09	0,10	0,11
	80	70	70		0,06	0,07	0,08	0,08	0,10	0,11
	55	50	50		0,06	0,06	0,07	0,07	0,08	0,09
	60	50	50		0,06	0,06	0,07	0,07	0,08	0,10
	50	45	45		0,05	0,05	0,06	0,07	0,07	0,08
	50	35	40		0,05	0,05	0,05	0,06	0,06	0,07
	80	70	70		0,06	0,07	0,08	0,08	0,10	0,11
	45	30	30		0,04	0,04	0,05	0,05	0,06	0,06
	95	70	70	70	0,06	0,07	0,08	0,09	0,10	0,12
	130	80	95	95	0,07	0,07	0,08	0,09	0,11	0,13
	80	60	60		0,06	0,07	0,08	0,09	0,10	0,11
	70	65	65		0,07	0,08	0,08	0,09	0,11	0,12
	65	55	55		0,06	0,07	0,08	0,08	0,09	0,11

Los valores de corte indicados son de referencia.

Los datos óptimos para cada situación de mecanizado deben determinarse mediante ensayos o durante el propio proceso de mecanizado.

Recomendación de valores de corte para taladro profundo

Avance y velocidad de corte

MEGA-Deep-Drill | SCD171

Grupo de arranque de virutas de Mapal*		Material	Rigidez/dureza [N/mm ²] [HRC]
P	P1	P1.1 Aceros de construcción, para tornos automáticos, de cementación y revenidos, no aleados	< 700
		P1.2 Aceros de construcción, para tornos automáticos, de cementación y revenidos, no aleados	< 1200
	P2	P2.1 Aceros nitrurados, de cementación y aceros revenidos, aleados	< 900
		P2.2 Aceros nitrurados, de cementación y aceros revenidos, aleados	< 1400
	P3	P3.1 Aceros para herramientas, rodamientos, resortes y rápidos**	< 800
		P3.2 Aceros para herramientas, rodamientos, resortes y rápidos**	< 1000
		P3.3 Aceros para herramientas, rodamientos, resortes y rápidos**	< 1500
	P5	P5.1 Fundición de acero	
K	K1	K1.1 Hierro fundido con grafito laminar (fundición gris), GJL	< 300
		K1.2 Hierro fundido con grafito esferoidal, GJS	< 500
	K2	K2.2 Hierro fundido con grafito esferoidal, GJS	≤ 800
		K2.3 Hierro fundido con grafito esferoidal, GJS	> 800
	K3	K3.1 Hierro fundido con grafito vermicular, GJV; fundición maleable, GJM	< 500
		K3.2 Hierro fundido con grafito vermicular, GJV; fundición maleable, GJM	> 500

MEGA-Deep-Drill-Alu | SCD181

Grupo de arranque de virutas de Mapal*		Material	Rigidez/dureza [N/mm ²] [HRC]
N	N1	N1.1 Aluminio, aleado y no aleado < 3 % Si	
		N1.2 Aluminio, aleado ≤ 7 % Si	
		N1.3 Aluminio, aleado > 7-12 % Si	
		N1.4 Aluminio, aleado > 12 % Si	
	N2	N2.1 Cobre, no aleado y de baja aleación	< 300
		N2.2 Cobre, aleado	> 300
		N2.3 Latón, bronce, fundición roja	< 1200

* Grupos de mecanizado MAPAL

** Si los componentes de aleación de Cr, Mo, Ni, V, W suman > 8 %, elegir el siguiente grupo de mecanizado MAPAL superior.

	Velocidad de corte v_c [m/min]			Avance f [mm] con diámetro de broca					
	Refrigeración interna	MMS	Aire	1,00	2,00	4,00	6,00	9,00	16,00
	90	80		0,04	0,06	0,09	0,13	0,19	0,27
	80	70		0,06	0,08	0,11	0,16	0,24	0,34
	90	75		0,05	0,07	0,10	0,16	0,23	0,32
	65	55		0,05	0,07	0,09	0,13	0,18	0,25
	70	60		0,05	0,06	0,09	0,14	0,21	0,29
	55	50		0,04	0,06	0,08	0,12	0,17	0,23
	55	45		0,04	0,05	0,07	0,09	0,13	0,18
	90	75		0,05	0,07	0,10	0,16	0,23	0,32
	110	75	75	0,14	0,18	0,25	0,32	0,41	0,53
	145	110	110	0,14	0,18	0,24	0,30	0,38	0,49
	90	70		0,13	0,16	0,21	0,26	0,33	0,42
	55	45		0,10	0,12	0,14	0,18	0,22	0,28
	80	70		0,14	0,18	0,22	0,28	0,36	0,46
	70	65		0,12	0,15	0,18	0,23	0,29	0,36

	Velocidad de corte v_c [m/min]			Avance f [mm] con diámetro de broca					
	Refrigeración interna	MMS	Aire	3,00	4,00	5,50	7,50	10,50	16,00
	300	250		0,11	0,13	0,16	0,20	0,25	0,32
	250	200		0,13	0,16	0,21	0,26	0,33	0,42
	220	180		0,13	0,16	0,21	0,26	0,33	0,42
	180	150		0,13	0,16	0,21	0,26	0,33	0,42
	140			0,09	0,11	0,14	0,17	0,21	0,27
	120			0,11	0,14	0,17	0,22	0,28	0,35
	200	160	120	0,14	0,18	0,25	0,32	0,41	0,53

Los valores de corte indicados son de referencia.

Los datos óptimos para cada situación de mecanizado deben determinarse mediante ensayos o durante el propio proceso de mecanizado.



ESCARIADO

Broca escariadora

Tecnología 290

Tritan-Drill-Reamer 292

Anexo técnico

Recomendación de valores de corte 298

TRITAN-DRILL-REAMER

La solución más precisa para el taladrado y escariado en un solo paso

Para una producción lo más rentable posible, un método probado consiste en combinar varios pasos de mecanizado en una sola herramienta. Por ejemplo, los agujeros pueden ser perforados y escariados simultáneamente con el Tritan-Drill-Reamer de MAPAL.

Para poder practicar agujeros de ajuste con mayor precisión con una sola herramienta, MAPAL ha desarrollado el Tritan-Drill-Reamer.

Con seis biseles guía para un guiado excelente, ranuras de alojamiento de virutas muy finamente afiladas con ranura de forma adaptada para una retirada óptima de virutas, así como una cuchilla transversal con autocentrado, la nueva Tritan-Drill-Reamer convence en toda la línea.

La cuchilla transversal con autocentrado proporciona una buena precisión de posicionamiento y un comportamiento mejorado del taladrado. Los tres insertos garantizan una circularidad óptima del agujero de ajuste y un rendimiento máximo. Los biseles guía crean las mejores superficies.

CARACTERÍSTICAS

- Combinación del taladrado y el escariado
- Ejecución de longitud 3xD y 5xD
- Tres insertos y seis biseles guía
- Con refrigeración interna
- Ejecuciones de tolerancia $\pm 0,003$ mm y H7

VENTAJAS

- Reducción de los periodos principales y los no productivos
- Máximo rendimiento y precisión
- Gran precisión de posicionamiento
- Circularidad óptima

Características detalladas de la herramienta

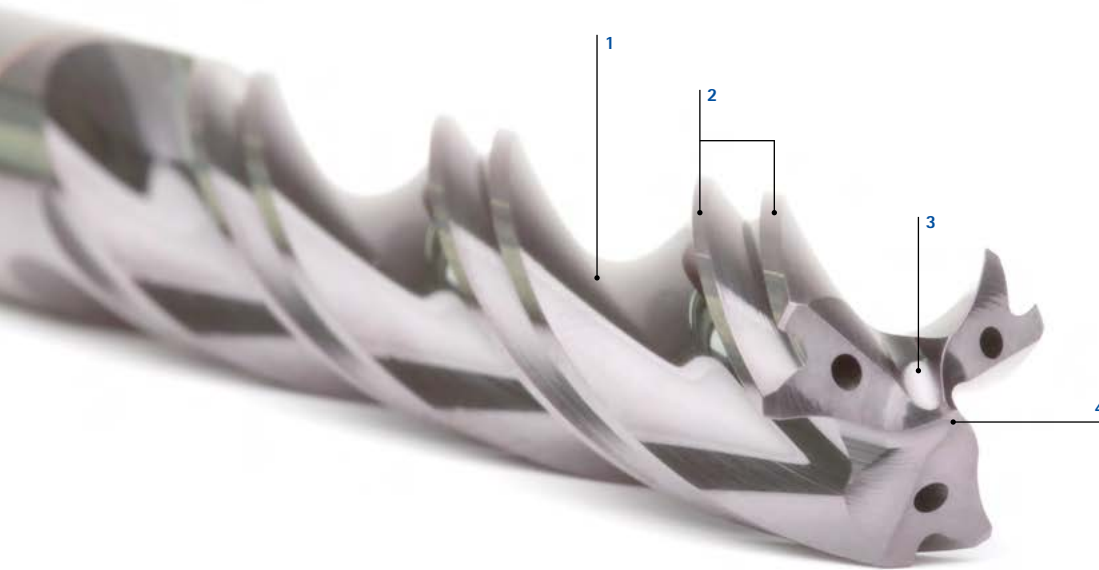

1 Perfil de ranura muy finamente afilado

2 Seis biseles guía

3 Punta innovadora

4 Cuchilla transversal con autocentrado



Seis biseles guía

- Para un guiado excelente
- Para practicar agujeros de ajuste con la máxima rentabilidad y precisión con una sola herramienta



Innovadora punta de centrado

- Cuchilla transversal con autocentrado para una excelente precisión de posicionamiento y un comportamiento mejorado del taladrado



Perfil de ranura muy finamente afilado

- Ranuras de alojamiento de virutas muy finamente afiladas con ranura de forma adaptada para una excelente retirada de virutas



Comparación Tritan-Drill-Reamer y solución de doble filo

Desviación del diámetro de la herramienta medido (42CrMoS4)

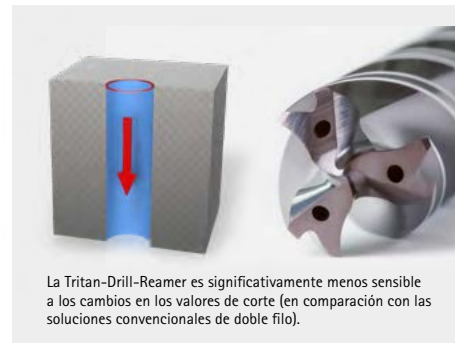
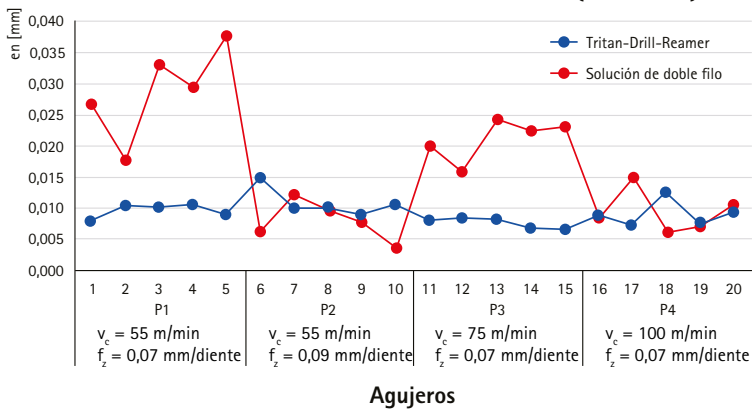

Circularidad en 600 agujeros

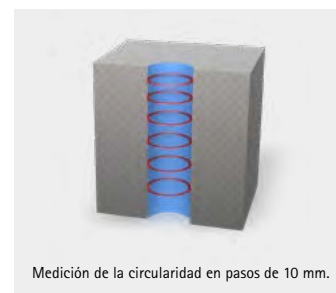
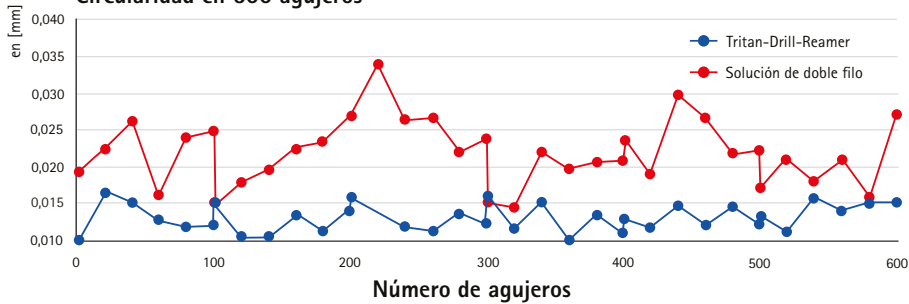

Tritan-Drill-Reamer

Broca escariadora

SDR301G (3xD), con suministro de refrigerante interior

Ejecución:

Diámetro de broca: 3,80 – 20,05 mm
 Tolerancia del agujero: $\geq IT 7$
 Material de corte: HP358
 Número de insertos: 3
 Número de bisel guía: 6
 Ángulo de la punta: 140°
 Ángulo de hélice: 30°

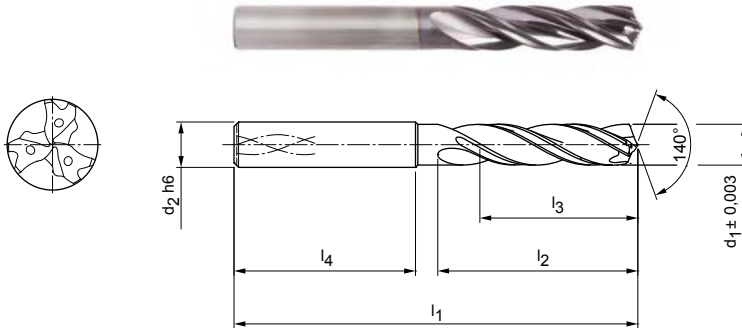

Serie preferente disponible en stock en forma de mango HA

Dimensiones						Forma del mango HA	
$d_1 \pm 0,003$	$d_2 h6$	l_1	l_2	l_3	l_4	Especificación	Referencia
3,99	6	66	24	17	36	SDR301G-3.990+3-3-HA03-HP358	31196569
4,00	6	66	24	17	36	SDR301G-4.000+3-3-HA03-HP358	31196570
4,01	6	66	24	17	36	SDR301G-4.010+3-3-HA03-HP358	31196571
4,99	6	66	28	20	36	SDR301G-4.990+3-3-HA03-HP358	31196575
5,00	6	66	28	20	36	SDR301G-5.000+3-3-HA03-HP358	31196576
5,01	6	66	28	20	36	SDR301G-5.010+3-3-HA03-HP358	31196577
5,02	6	66	28	20	36	SDR301G-5.020+3-3-HA03-HP358	31196578
5,99	6	66	28	20	36	SDR301G-5.990+3-3-HA03-HP358	31196581
6,00	6	66	28	20	36	SDR301G-6.000+3-3-HA03-HP358	31196582
6,01	6	66	28	20	36	SDR301G-6.010+3-3-HA03-HP358	31196583
7,99	8	79	41	29	36	SDR301G-7.990+3-3-HA03-HP358	31196587
8,00	8	79	41	29	36	SDR301G-8.000+3-3-HA03-HP358	31196588
8,01	8	79	41	29	36	SDR301G-8.010+3-3-HA03-HP358	31196589
9,99	10	89	47	35	40	SDR301G-9.990+3-3-HA03-HP358	31196593
10,00	10	89	47	35	40	SDR301G-10.000+3-3-HA03-HP358	31196594
10,01	10	89	47	35	40	SDR301G-10.010+3-3-HA03-HP358	31196595
10,02	10	89	47	35	40	SDR301G-10.020+3-3-HA03-HP358	31196596
11,99	12	102	55	40	45	SDR301G-11.990+3-3-HA03-HP358	31196599
12,00	12	102	55	40	45	SDR301G-12.000+3-3-HA03-HP358	31196600
12,01	12	102	55	40	45	SDR301G-12.010+3-3-HA03-HP358	31196601
13,99	14	107	60	43	45	SDR301G-13.990+3-3-HA03-HP358	31196605
14,00	14	107	60	43	45	SDR301G-14.000+3-3-HA03-HP358	31196606
14,01	14	107	60	43	45	SDR301G-14.010+3-3-HA03-HP358	31196607
15,99	16	115	65	45	48	SDR301G-15.990+3-3-HA03-HP358	31196611
16,00	16	115	65	45	48	SDR301G-16.000+3-3-HA03-HP358	31196612
16,01	16	115	65	45	48	SDR301G-16.010+3-3-HA03-HP358	31196613

Tritan-Drill-Reamer | Broca escariadora SDR301G (3xD), con suministro de refrigerante interior

Características configurables

**Diámetro:**

Diámetro seleccionable libremente en incrementos de 0,001 mm

**Especificación**

SDR301G-[diámetro]+3-3-HA03-HP358

Ejemplo:

SDR301G-4.001+3-3-HA03-HP358

Diámetro de la herramienta $d_1 = 4,001$ mm

Dimensiones de la serie configurable

d_1 mín.	d_1 máx.	d_2 h6	l_1	l_2	l_3	l_4
3,800	4,700	6	66	24	17	36
4,701	6,050	6	66	28	20	36
6,051	8,050	8	79	41	29	36
8,051	10,050	10	89	47	35	40
10,051	12,050	12	102	55	40	45
12,970	14,050	14	107	60	43	45
14,970	16,050	16	115	65	45	48
16,800	18,050	18	123	73	51	48
18,700	20,050	20	131	79	55	50

Medidas en mm.

Para los agujeros de ajuste de las clases de tolerancia hasta un máximo de IT7, con suficiente estabilidad y refrigeración de la máquina.

Si desea ayuda para calcular el diámetro nominal óptimo para los diferentes agujeros de ajuste, consulte el campo de información al final del capítulo.

Para la recomendación de valores de corte, véase al final del capítulo.

Ejecuciones especiales y otros recubrimientos a petición.

Tritan-Drill-Reamer

Broca escariadora

SDR301 (3xD), con suministro de refrigerante interior

Ejecución:

Diámetro de broca: 4,00 – 16,00 mm
 Tolerancia del agujero: \geq IT 7
 Material de corte: HP358
 Número de insertos: 3
 Número de bisel guía: 6
 Ángulo de la punta: 140°
 Ángulo de hélice: 30°

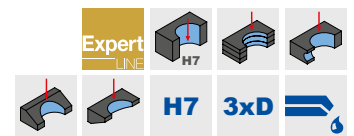
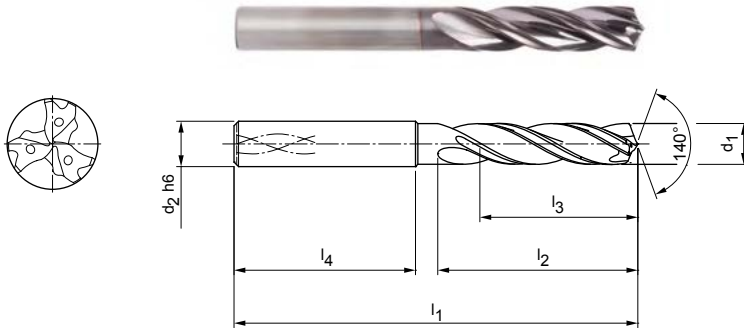

Serie preferente disponible en stock en forma de mango HA

Dimensiones						Forma del mango HA	
d ₁ H7	d ₂ h6	l ₁	l ₂	l ₃	l ₄	Especificación	Referencia
4,00	6	66	24	17	36	SDR301-4.000H7-HA03-HP358	31196337
5,00	6	66	28	20	36	SDR301-5.000H7-HA03-HP358	31196338
6,00	6	66	28	20	36	SDR301-6.000H7-HA03-HP358	31196339
8,00	8	79	41	29	36	SDR301-8.000H7-HA03-HP358	31196560
10,00	10	89	47	35	40	SDR301-10.000H7-HA03-HP358	31196561
12,00	12	102	55	40	45	SDR301-12.000H7-HA03-HP358	31196562
14,00	14	107	60	43	45	SDR301-14.000H7-HA03-HP358	31196563
16,00	16	115	65	45	48	SDR301-16.000H7-HA03-HP358	31196564

Medidas en mm.

Para los agujeros de ajuste de la clase de tolerancia H7, con suficiente estabilidad y refrigeración de la máquina.

Para la recomendación de valores de corte, véase al final del capítulo.

Ejecuciones especiales y otros recubrimientos a petición.

Tritan-Drill-Reamer

Broca escariadora

SDR301G (5xD), con suministro de refrigerante interior

Ejecución:

Diámetro de broca: 3,80 – 20,05 mm
 Tolerancia del agujero: \geq IT 7
 Material de corte: HP358
 Número de insertos: 3
 Número de bisel guía: 6
 Ángulo de la punta: 140°
 Ángulo de hélice: 30°

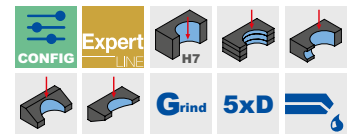
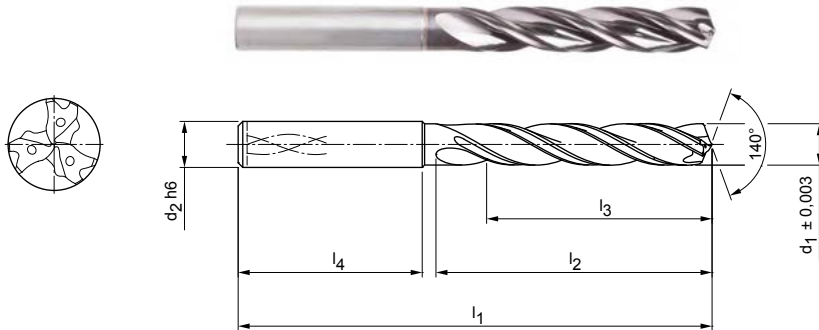

Serie preferente disponible en stock en forma de mango HA

Dimensiones						Forma del mango HA	
$d_1 \pm 0,003$	$d_2 h6$	l_1	l_2	l_3	l_4	Especificación	Referencia
3,99	6	74	36	29	36	SDR301G-3.990+3-3-HA05-HP358	31196639
4,00	6	74	36	29	36	SDR301G-4.000+3-3-HA05-HP358	31196640
4,01	6	74	36	29	36	SDR301G-4.010+3-3-HA05-HP358	31196641
4,02	6	74	36	29	36	SDR301G-4.020+3-3-HA05-HP358	31196642
4,99	6	82	44	35	36	SDR301G-4.990+3-3-HA05-HP358	31196645
5,00	6	82	44	35	36	SDR301G-5.000+3-3-HA05-HP358	31196646
5,01	6	82	44	35	36	SDR301G-5.010+3-3-HA05-HP358	31196647
5,99	6	82	44	35	36	SDR301G-5.990+3-3-HA05-HP358	31196651
6,00	6	82	44	35	36	SDR301G-6.000+3-3-HA05-HP358	31196652
6,01	6	82	44	35	36	SDR301G-6.010+3-3-HA05-HP358	31196653
7,99	8	91	53	43	36	SDR301G-7.990+3-3-HA05-HP358	31196658
8,00	8	91	53	43	36	SDR301G-8.000+3-3-HA05-HP358	31196659
8,01	8	91	53	43	36	SDR301G-8.010+3-3-HA05-HP358	31196660
8,02	8	91	53	43	36	SDR301G-8.020+3-3-HA05-HP358	31196661
9,99	10	103	61	49	40	SDR301G-9.990+3-3-HA05-HP358	31196664
10,00	10	103	61	49	40	SDR301G-10.000+3-3-HA05-HP358	31196665
10,01	10	103	61	49	40	SDR301G-10.010+3-3-HA05-HP358	31196666
11,99	12	118	71	59	45	SDR301G-11.990+3-3-HA05-HP358	31196670
12,00	12	118	71	59	45	SDR301G-12.000+3-3-HA05-HP358	31196671
12,01	12	118	71	59	45	SDR301G-12.010+3-3-HA05-HP358	31196672
13,99	14	124	77	60	45	SDR301G-13.990+3-3-HA05-HP358	31196676
14,00	14	124	77	60	45	SDR301G-14.000+3-3-HA05-HP358	31196677
14,01	14	124	77	60	45	SDR301G-14.010+3-3-HA05-HP358	31196678
15,99	16	133	83	63	48	SDR301G-15.990+3-3-HA05-HP358	31196682
16,00	16	133	83	63	48	SDR301G-16.000+3-3-HA05-HP358	31196683
16,01	16	133	83	63	48	SDR301G-16.010+3-3-HA05-HP358	31196684

Continúa en la página siguiente.

Tritan-Drill-Reamer | Broca escariadora SDR301G (5xD), con suministro de refrigerante interior

Características configurables

**Diámetro:**

Diámetro seleccionable libremente en incrementos de 0,001 mm

**Especificación**

SDR301G-[diámetro]+3-3-HA05-HP358

Ejemplo:

SDR301G-04001+3-3-HA05-HP358

Diámetro de la herramienta $d_1 = 4,001$ mm

Dimensiones de la serie configurable

d_1 mín.	d_1 máx.	d_2 h6	l_1	l_2	l_3	l_4
3,800	4,700	6	74	36	29	36
4,701	6,050	6	82	44	35	36
6,051	8,050	8	91	53	43	36
8,051	10,050	10	103	61	49	40
10,051	12,050	12	118	71	56	45
12,970	14,050	14	124	77	60	45
14,970	16,050	16	133	83	63	48
16,800	18,050	18	143	93	71	48
18,700	20,050	20	153	101	77	50

Medidas en mm.

Para los agujeros de ajuste de las clases de tolerancia hasta un máximo de IT7, con suficiente estabilidad y refrigeración de la máquina.

Si desea ayuda para calcular el diámetro nominal óptimo para los diferentes agujeros de ajuste, consulte el campo de información al final del capítulo.

Para la recomendación de valores de corte, véase al final del capítulo.

Ejecuciones especiales y otros recubrimientos a petición.

Tritan-Drill-Reamer

Broca escariadora

SDR301 (5xD), con suministro de refrigerante interior

Ejecución:

Diámetro de broca: 4,00 – 20,00 mm
 Tolerancia del agujero: \geq IT 7
 Material de corte: HP358
 Número de insertos: 3
 Número de bisel guía: 6
 Ángulo de la punta: 140°
 Ángulo de hélice: 30°

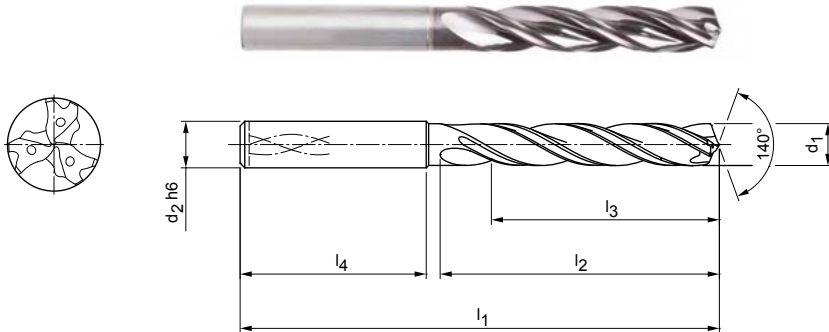

Serie preferente disponible en stock en forma de mango HA

Dimensiones						Forma del mango HA	
d ₁ H7	d ₂ h6	l ₁	l ₂	l ₃	l ₄	Especificación	Referencia
4,00	6	74	36	29	36	SDR301-4.000H7-HA05-HP358	31196627
5,00	6	82	44	35	36	SDR301-5.000H7-HA05-HP358	31196628
6,00	6	82	44	35	36	SDR301-6.000H7-HA05-HP358	31196629
8,00	8	91	53	43	36	SDR301-8.000H7-HA05-HP358	31196630
10,00	10	103	61	49	40	SDR301-10.000H7-HA05-HP358	31196631
12,00	12	118	71	56	45	SDR301-12.000H7-HA05-HP358	31196632
14,00	14	124	77	60	45	SDR301-14.000H7-HA05-HP358	31196633
16,00	16	133	83	63	48	SDR301-16.000H7-HA05-HP358	31196634
18,00	18	143	93	71	48	SDR301-18.000H7-HA05-HP358	31196635
20,00	20	153	101	77	50	SDR301-20.000H7-HA05-HP358	31196636

Medidas en mm.

Para los agujeros de ajuste de la clase de tolerancia H7, con suficiente estabilidad y refrigeración de la máquina.

Para la recomendación de valores de corte, véase al final del capítulo.

Ejecuciones especiales y otros recubrimientos a petición.

Recomendación de valores de corte para brocas escariadoras

Avance y velocidad de corte

Tritan-Drill-Reamer | SDR301

Grupo de arranque de virutas de Mapal*	Material	Rigidez/dureza [N/mm ²] [HRC]
P	P1.1 Aceros de construcción, para tornos automáticos, de cementación y revenidos, no aleados	< 700
	P1.2 Aceros de construcción, para tornos automáticos, de cementación y revenidos, no aleados	< 1200
	P2.1 Aceros nitrurados, de cementación y aceros revenidos, aleados	< 900
	P2.2 Aceros nitrurados, de cementación y aceros revenidos, aleados	< 1400
	P3.1 Aceros para herramientas, rodamientos, resortes y rápidos**	< 800
	P3.2 Aceros para herramientas, rodamientos, resortes y rápidos**	< 1000
	P3.3 Aceros para herramientas, rodamientos, resortes y rápidos**	< 1500
	P5.1 Fundición de acero	
K	K1.1 Hierro fundido con grafito laminar (fundición gris), GJL	< 300
	K2.1 Hierro fundido con grafito esferoidal, GJS	< 500
	K2.2 Hierro fundido con grafito esferoidal, GJS	≤ 800
	K2.3 Hierro fundido con grafito esferoidal, GJS	> 800
	K3.1 Hierro fundido con grafito vermicular, GJV; fundición maleable, GJM	< 500
	K3.2 Hierro fundido con grafito vermicular, GJV; fundición maleable, GJM	> 500

EJEMPLO DE CÁLCULO

Tenga en cuenta que el resultado puede verse influido por parámetros adicionales como la máquina herramienta o la sujeción de la herramienta.

Fórmula para calcular el diámetro nominal óptimo de la herramienta:

$$(G_{oB} + G_{uB}) / 2$$

Ejemplo:

- Agujero de ajuste: \varnothing 10 F7
- Dimensión máxima del agujero G_{oB} : 10,028 mm
- Dimensión mínima del agujero G_{uB} : 10,013 mm

$$\rightarrow (10,028 \text{ mm} + 10,013 \text{ mm}) / 2 = 10,021 \text{ mm} = \text{Selección del diámetro nominal de la herramienta } 10,021 \text{ mm}$$

* Grupos de mecanizado MAPAL

** Si los componentes de aleación de Cr, Mo, Ni, V, W suman > 8 %, elegir el siguiente grupo de mecanizado MAPAL superior.

	Velocidad de corte v_c [m/min]				Avance f [mm] con diámetro de broca					
	Refrigeración interna	Refrigeración exterior	MMS	Aire	4,00	5,50	7,50	10,50	14,50	20,00
	70	65	65		0,17	0,22	0,27	0,34	0,41	0,47
	65	55	55		0,22	0,27	0,34	0,42	0,51	0,59
	70	60	60		0,20	0,26	0,32	0,40	0,48	0,56
	50	40	40		0,17	0,21	0,26	0,32	0,38	0,44
	55	45	45		0,18	0,23	0,29	0,36	0,43	0,50
	40	40	40		0,15	0,19	0,24	0,30	0,36	0,41
	40	30	35		0,13	0,16	0,19	0,23	0,28	0,32
	70	60	60		0,20	0,26	0,32	0,40	0,48	0,56
	100	70	70	70	0,25	0,33	0,42	0,55	0,67	0,79
	135	85	100	100	0,24	0,32	0,40	0,51	0,62	0,72
	85	65	65		0,22	0,28	0,35	0,44	0,54	0,62
	50	35	45		0,11	0,13	0,16	0,20	0,24	0,28
	75	70	70		0,23	0,30	0,38	0,47	0,58	0,67
	70	60	60		0,20	0,25	0,31	0,38	0,46	0,53

Los valores de corte indicados son de referencia.

Los datos óptimos para cada situación de mecanizado deben determinarse mediante ensayos o durante el propio proceso de mecanizado.

SOLUCIONES ESPECIALES

Barrenado en sólido con metal duro

Además de un programa estándar completo de herramientas de taladrado, MAPAL ofrece herramientas especiales.

Los requisitos de cada cliente requieren unas soluciones especiales, especialmente adaptadas a las tareas de mecanizado. Gracias a sus amplios conocimientos sobre el mecanizado de metal y a su extensa experiencia, MAPAL es el socio competente a escala mundial para la construcción y fabricación de herramientas especiales, así como para el diseño de procesos completos de arranque de virutas para el mecanizado de agujeros. El programa comprende brocas con ranuras en espiral y ranuras rectas, así como brocas escalonadas completas en metal duro y también brocas de PCD.

MAPAL: su socio para soluciones especiales, específicas para cada aplicación.





Herramientas especiales para el taladrado de MAPAL

- 1 Broca escalonada especial fabricada íntegramente en metal duro (MD) con tres insertos, cuchilla transversal con autocentrado, para mecanizar bielas en un solo paso
- 2 Broca escalonada fabricada íntegramente en metal duro (MD) con tres biselos guía y recubrimiento especial para el mecanizado a alta velocidad
- 3 Broca de agujeros para rosca fabricada íntegramente en metal duro (MD) para el mecanizado de bielas en el proceso de dos pasos
- 4 Broca escalonada fabricada íntegramente en metal duro (MD) con tres biselos guía y recubrimiento especial para el mecanizado a alta velocidad de articulaciones de muñón de eje de ADI 900
- 5 Broca escalonada fabricada íntegramente en metal duro (MD) con geometría Tritan-Drill y recubrimiento especial para el mecanizado de turbocargadores
- 6 Broca escariadora con tres insertos y filos escariadores adicionales en el perímetro con recubrimiento especial para el mecanizado de ejes de GJS
- 7 Broca piloto fabricada íntegramente en metal duro (MD) para el mecanizado de bielas en el proceso de dos pasos
- 8 Taladro profundo fabricado íntegramente en metal duro (MD) con recubrimiento especial para el mecanizado de bloques de cilindros de GJV
- 9 Broca de aluminio de metal duro (MD) con tres insertos, cuchilla transversal con autocentrado y ranuras de alojamiento de virutas pulidas con alto brillo para el mecanizado de AISI1
- 10 Broca escalonada fabricada íntegramente en metal duro (MD) con afilado frontal de 180° para el mecanizado de válvulas



SOLUCIONES ESPECIALES

Barrenado en sólido con PCD

En el mecanizado de componentes de aluminio y otros metales no ferrosos, para el taladrado suelen utilizarse herramientas de PCD con ranuras rectas. Las características de la herramienta están óptimamente adaptadas entre sí para lograr un alto rendimiento de las brocas de PCD. Las ranuras de alojamiento de virutas están pulidas en toda la longitud de la broca, con el fin de mantener lo más baja posible la fricción de las virutas. Los insertos de PCD óptimamente integrados proporcionan un buen comportamiento de corte de las brocas. De este modo también se reduce la entrada de calor en el componente.

En los procesos con lubricación minimizada (MQL), MAPAL ha adaptado la ubicación de las salidas de refrigerante en las herramientas, para que el aerosol llegue exactamente a los lugares donde se necesita la lubricación. De este modo se reduce el riesgo de recrecimiento de los filos y se prolonga la vida útil de la broca.

Sin embargo, los modernos procesos de mecanizado requieren, cada vez más, unas herramientas de taladro de PCD con un gran ángulo de hélice.

Las herramientas de PCD en espiral permiten un mecanizado seguro y productivo del agujero. El estancamiento de las virutas o la rotura de la herramienta se evitan mediante una evacuación «mecánica» de las virutas. Los ángulos de desprendimiento muy positivos reducen las fuerzas de corte necesarias. Varias operaciones, como el proceso de barrenado en sólido y mandrinado, pueden realizarse en un solo paso de trabajo. La reducción del tiempo de mecanizado aumenta la productividad con una elevada seguridad en el proceso y una alta calidad.

Características detalladas de la herramienta



1 Insertos de PCD

2 Ranura de alojamiento de virutas en espiral y pulida con alto brillo

3 Salidas de refrigerante optimizadas para el proceso MQL

Insertos de PCD óptimamente integrados

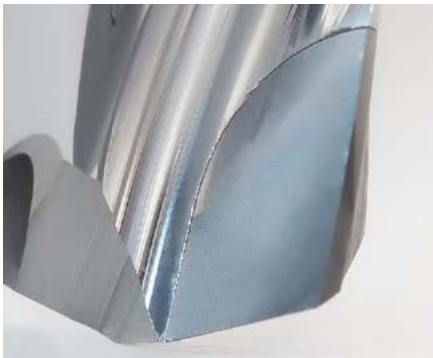

La integración óptima de segmentos de PCD en una ranura en espiral, redondeada por todos los lados, representa grandes exigencias en lo que a la técnica de producción se refiere. Un equipamiento de producción de última generación asegura que las herramientas de taladrado de PCD en espiral puedan diseñarse y fabricarse de forma segura y reproducible. Para mejorar continuamente las herramientas, durante el diseño y la construcción se tienen en cuenta amplios detalles de aplicación, proporcionados por los asesores técnicos y especialistas de producto de MAPAL.

Ranura de alojamiento de virutas pulida con alto brillo



Las ranuras de alojamiento de virutas están pulidas con alto brillo, de modo que se reduce la fricción de las virutas y, consecuentemente, también disminuye la entrada de calor en el componente. La ejecución en espiral de las ranuras de alojamiento de virutas permite una evacuación «mecánica» de las virutas. Los ángulos de desprendimiento muy positivos reducen las fuerzas de corte necesarias.

Óptima para procesos MQL



La correcta ubicación de las salidas de refrigerante en el mecanizado con lubricación minimizada (MQL) es decisiva para el rendimiento de la broca. El aerosol debe llegar a los lugares donde es necesaria la lubricación. De este modo, por ejemplo, se reduce el riesgo de recrecimiento de los filos y, naturalmente, también se prolonga la vida útil de la broca.



ESCARIADO Y TALADRADO DE PRECISIÓN

Máxima precisión con el principio MAPAL



VISTA GENERAL DE LOS PRODUCTOS

Escariado y taladrado de precisión

Las herramientas para el mecanizado de precisión de agujeros son el punto fuerte de MAPAL. La historia de éxito comenzó en el año 1954 con el «escariador primitivo», y hasta el día de hoy MAPAL sigue cosechando éxitos en este ámbito. Décadas de experiencia, el constante perfeccionamiento y la continua optimización de sus soluciones de herramientas permiten a MAPAL ofrecer la solución adecuada según la complejidad del mecanizado y los requisitos de precisión. Además de las soluciones especiales personalizadas, se dispone de un variado programa estándar de herramientas para el escariado y taladrado de precisión.

El escariado y el taladrado de precisión son los métodos más comunes para el mecanizado de precisión de los agujeros y convencer gracias a

sus resultados de máxima precisión. La elevada precisión que ofrecen las herramientas MAPAL en la práctica es el reflejo de la precisión con la que MAPAL fabrica sus herramientas. En función del grado de complejidad del mecanizado y de las exigencias en cuanto a precisión y superficie, MAPAL ofrece la solución adecuada:

Los escariadores de un filo, las herramientas de taladrado de precisión con guías de apoyo y los insertos WP son sinónimo de máxima precisión. Además, el programa incluye escariadores de múltiples filos: escariadores de cabezal intercambiable HPR en combinación con el sistema de sujeción altamente preciso, escariadores de alto rendimiento fabricados íntegramente en metal duro o cermet, así como sistemas para el mecanizado de diámetros grandes.



Basic Line:
Herramientas universales, amplia gama de aplicación, costes de adquisición reducidos



Performance Line:
Herramientas de alto rendimiento, amplia gama de aplicación, alta productividad en la fabricación en serie



Expert Line:
Herramientas especializadas para aplicaciones seleccionadas, máxima precisión y productividad

Escariadores fijos de múltiples filos		Herramientas con guías de apoyo	
 <p>Escariador de alto rendimiento FXR</p> <p>Los escariadores de alto rendimiento de la serie FXR (ideales cuando se requieren tiempos de ciclo breves) están disponibles con diferentes materiales de corte y recubrimientos. Esto significa que casi todos los materiales pueden ser mecanizados con rentabilidad y seguridad de proceso. Sin ningún esfuerzo de ajuste, las herramientas, que están disponibles en el rango de diámetro de 2,800 a 20,200 mm, alcanzan las tolerancias IT7.</p> <p>Rango de Ø: 2,800 – 20,200 mm*</p> <p>P M K N C S</p>	 <p>Escariador con filo soldado de alto rendimiento MOR/MRP</p> <p>Sencillo, eficaz y estandarizado: así se puede resumir el sistema de escariado de la serie MonoReam. Los insertos de los escariadores de alto rendimiento de la serie FXR están soldados en el cuerpo. Los escariadores MOR, en contraste con los escariadores FXR, pueden ser reacondicionados. Para ello cuentan con un tornillo de expansión que amplía el diámetro del escariador y permite así el reafilado.</p> <p>Rango de Ø: 3,850 – 40,200 mm*</p> <p>P K N</p>	 <p>Escariador de cabezal intercambiable HPR con unión HFS</p> <p>Si se requiere la máxima rentabilidad, se recomienda el uso de escariadores de cabezal intercambiable HPR en el rango de diámetros pequeños. La unión de alta precisión HFS garantiza, a pesar del sistema de cabezal intercambiable, una concentricidad exacta, así como una alta precisión de cambio. El manejo es muy sencillo. Los escariadores HPR están disponibles con insertos fijos soldados e insertos ajustables.</p> <p>Rango de Ø: 7,000 – 65,000 mm*</p> <p>P M K S</p>	 <p>Escariador de un filo</p> <p>En cuanto a precisión, los escariadores de un filo con guías de apoyo basadas en el principio de MAPAL, son prácticamente inigualables. Sus placas de corte están disponibles con dos filos de corte y entradas especiales.</p> <p>Rango de Ø: 5,000 – 30,290 mm*</p> <p>P M K N S H</p>
Página 316	Página 350	Página 368	Página 478

* El rango de diámetros puede variar según la serie.



	Soluciones para diámetros grandes	Soluciones especiales
		
<p>Sistema EasyAdjust</p> <p>La reducción significativa del esfuerzo de ajuste en las herramientas con tecnología de guías de apoyo fue el objetivo del desarrollo del sistema EasyAdjust. La pieza central del sistema es un innovador cartucho, que aloja los insertos de corte de seis o cuatro filos sin holgura y de forma estable. El estrechamiento del filo secundario ya se encuentra integrado en el cartucho, quedando eliminado este esfuerzo de ajuste. Mediante el guiado exacto del cartucho sobre un pasador de guiado de precisión, el estrechamiento se mantiene sin modificación también durante el ajuste del diámetro.</p> <p>Rango de Ø: a partir de 20,000 mm*</p> <p>P M K N S H</p>	<p>Soluciones para diámetros grandes</p> <p>Escariadores de alto rendimiento de múltiples filos para rangos de diámetros grandes. HPR400: rápido cambio de los insertos in situ sin necesidad de un largo reacondicionamiento. HPR400 plus: cuatro filos de corte en lugar de uno. Sencilla inversión y cambio de las placas de corte.</p> <p>Rango de Ø: 63,000 – 319,999 mm*</p> <p>P M K N H</p>	<p>Herramientas especiales a medida</p> <p>Las tareas de mecanizado especiales requieren herramientas particulares. Por este motivo, MAPAL ofrece escariadores con ejecuciones especiales, adaptados individualmente a los requisitos de los clientes. Gracias a las geometrías de entrada y a los recubrimientos especiales, así como a las herramientas escalonadas, las tareas respectivas se cumplen óptimamente. Las soluciones combinadas con tecnologías de herramientas adicionales de MAPAL pueden aumentar aún más la productividad y reducir los tiempos no productivos.</p>
<p>Página 514</p>	<p>Página 562</p>	<p>Página 572</p>

SISTEMA DE SELECCIÓN

Escariadores fijos de múltiples filos | Herramientas con guías de apoyo

Escariadores fijos de múltiples filos

Primera opción para las siguientes aplicaciones:

- Mecanizado a velocidades de avance elevadas
- Máximo rendimiento en la producción en serie
- Materiales abrasivos y duros
- Mecanizados con husillos múltiples
- Mecanizados con diámetro <5 mm



Herramientas con guías de apoyo

Primera opción para las siguientes aplicaciones:

- Condiciones de máquina inestables
- Ideal con portaherramientas flotante en el torno
- Mecanizados de nervios y componentes de paredes finas
- Relaciones de longitud y diámetro desfavorables
- Tolerancias de forma y posición extremadamente grandes





PROPIEDADES DE HERRAMIENTA

- Ejecuciones fijas sin esfuerzo de ajuste
- Ejecuciones de ajuste de precisión optimizadas para el reafilado
- Sistemas de cabezal intercambiable altamente precisos con manejo sencillo
- Diferentes clases de rendimiento incluidas en el programa estándar
- Reacondicionamiento para una alta rentabilidad
- Serie preferente disponible en almacén, dimensiones intermedias suministrables a corto plazo

Los escariadores fijos de múltiples filos permiten reducir considerablemente los tiempos de mecanizado. Gracias al aprovechamiento de todos los filos se obtienen unos valores de avance mucho mayores, lo que, en definitiva, determina los tiempos de mecanizado.

Debido a unos sistemas desarrollados específicamente y a una tecnología de fabricación de última generación, MAPAL también ofrece la máxima precisión en este tipo de herramientas.

► [Más información a partir de la página 311](#)



PROPIEDADES DE HERRAMIENTA

- Máxima precisión gracias a un ajuste exacto y de precisión micrométrica
- Tecnología de insertos reversibles para la selección del material de corte con la máxima versatilidad
- Pueden suministrarse a corto plazo dimensiones intermedias y todas las tolerancias

La tecnología de guías de apoyo MAPAL es inigualable para el mecanizado de precisión de agujeros en cualquier tipo de material de construcción. La precisión del diámetro del agujero, de la circularidad y de la forma cilíndrica, así como de la calidad de

superficie, no puede alcanzarse con otros medios de fabricación, o al menos no de forma económica.

► [Más información a partir de la página 477](#)



ESCARIADORES FIJOS DE MÚLTIPLES FILOS

Escariadores fijos de múltiples filos

Ayuda de selección	312
--------------------------	-----

FixReam FXR

Vista general de los productos	316
Vista general de la selección FXR	318
FXR510	322
FXR500	330
FXR505	332
FXR503-short	342
Recomendación de valores de corte	344

MonoReam MOR

Vista general de los productos	350
Vista general de la selección MOR/MRP	352
MOR710	356
MOR700	358
MOR705	359
MRP510	362
MRP505	363
Recomendación de valores de corte	364

Escariadores de cabezal intercambiable HPR











Vista general de los productos	368
Vista general de la selección HPR	370
HPR130	374
HPR131	379
HPR100	383
HPR110	390
HPR180	396
HPR150	405
HPR230	414
HPR231	418
HPR200	422
HPR210	426
HPR280	430
HPR250	438
Recomendación de valores de corte	446
Cota a remover en el escariado	458
Programa de portaherramientas HFS	460
Accesorios y refacciones	474

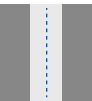

SELECCIÓN DE ESCARIADORES DE MÚLTIPLES FILOS

Paso a paso hasta el escariador correcto

Por ejemplo, ¿busca un escariador de múltiples filos fabricado íntegramente en metal duro con un diámetro 10,000 H7 para el mecanizado de un agujero ciego en acero? Esta ayuda de selección le guía paso a paso hasta el escariador correcto.

1	Diseño	Seleccione el diseño preferente (monolítico o modular).	 Monolítico	 Unión modular HFS
2	Características del agujero	Compruebe si las características de la geometría satisfacen sus requisitos. Seleccione el rango de diámetros y la tolerancia requerida.	 Rango de diámetros	 Tolerancia de taladrado alcanzable \geq IT
3	Clase de productos	Decídase por una clase de productos.	 Basic Line: Herramientas universales, amplia gama de aplicación, costes de adquisición reducidos	
4	Idoneidad del material	Determine el material de su pieza según el grupo de arranque de virutas Mapal (grupos de material a mecanizar MAPAL).	 Acero	 Acero inoxidable
5	Tipo de agujero	Compruebe los requisitos que debe cumplir su herramienta en función del tipo de agujero.	 Agujero pasante	 Agujero ciego
6	Producto	Seleccione su escariador. Los productos de la serie preferente disponible en stock se podrán suministrar en poco tiempo, mientras que los productos con características configurables se podrán configurar libremente dentro de los límites establecidos.	 Serie preferente disponible en stock	 Configuración libre





Performance Line:
Herramientas de alto rendimiento, amplia gama de aplicación, alta productividad en la fabricación en serie



Expert Line:
Herramientas especializadas para aplicaciones seleccionadas, máxima precisión y productividad



Hierro fundido



Metales no ferrosos y plásticos

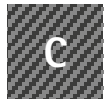

Materiales compuestos



Superalloys y titanio



Acero templado y fundición de acero

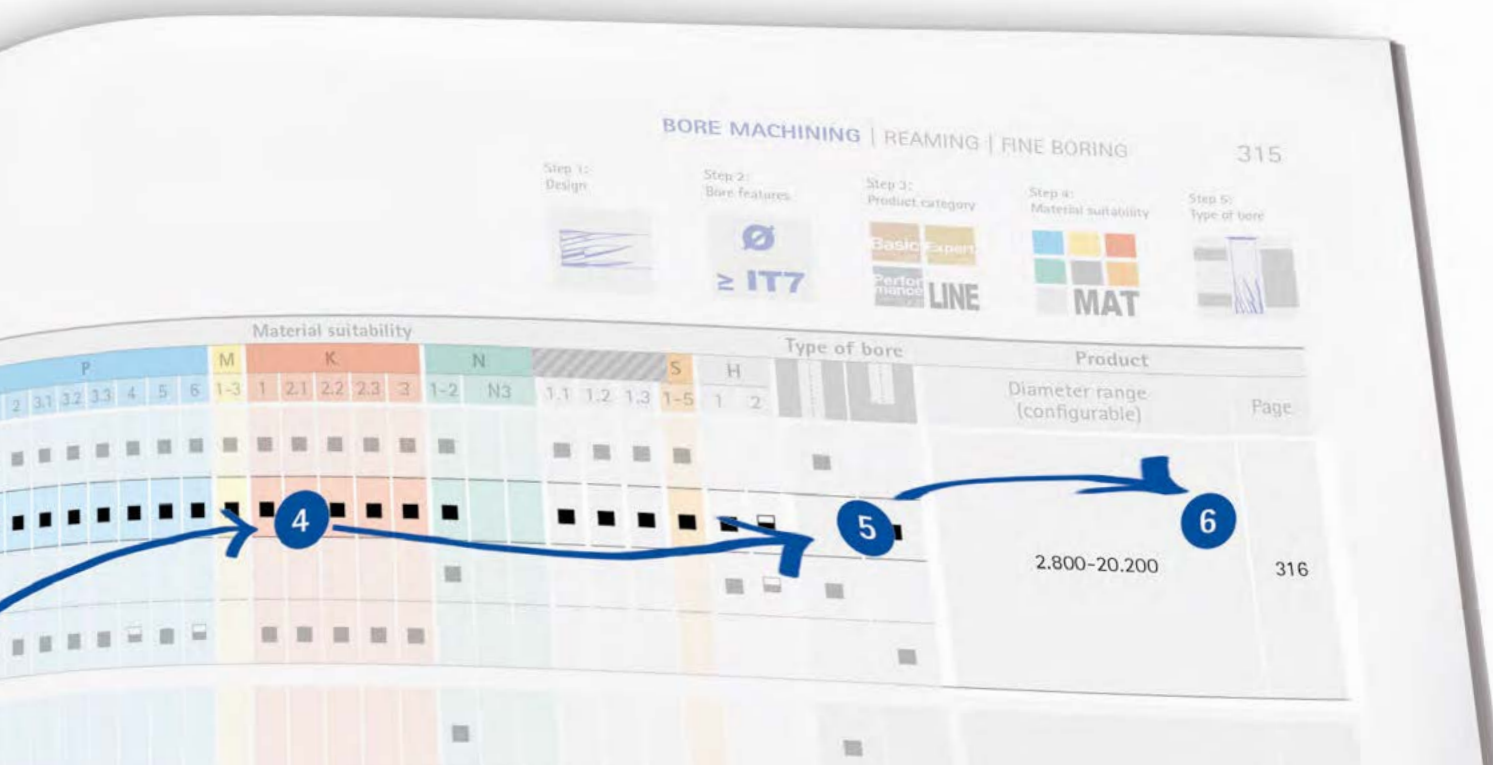



Escariador | Sistema de selección

Diseño	Rango de diámetros recomendado [mm]	Tolerancia	Serie			Clase de productos	
				Diámetro	Serie		
	3,000 - 14,000	≥ IT6	FixReam	<p>Escariador completo en metal duro para una gran variedad de usos. En función del diámetro, los escariadores de alto rendimiento FixReam disponen de entre cuatro y ocho insertos con refrigeración interna, y alcanzan de este modo unas elevadas velocidades de avance.</p>	2,800 - 20,200*	FXR510	Perforance LINE
					2,800 - 20,200*	FXR505	
					3,701 - 20,200*	FXR500	
					2,800 - 20,100*	FXR503	
	14,000 - 40,000	≥ IT6	MonoReam	<p>El MOR700 se utiliza como herramienta fija; sin embargo, esta serie está optimizada para el reafilado. A través del tornillo de expansión de una única pieza se expande el diámetro del escariador.</p>	7,700 - 40,200	MOR700	Perforance LINE
						MOR705	
						MOR710	
	4,000 - 8,000	≥ IT6	MonoReam Plus	<p>Especialmente para el mecanizado de fundición y acero. Un manguito asegura el abastecimiento óptimo de los insertos HPC con refrigerante.</p>	3,850 - 8,200	MRP505	Perforance LINE
						MRP510	
	7,000 - 65,000	≥ IT5	HPR	<p>Sistema de cabezal intercambiable altamente preciso en ejecución fija y de ajuste de precisión.</p>	7,000 - 65,000	HPR1XX fijo	Perforance LINE Expert LINE
					7,000 - 65,000	HPR2XX de ajuste de precisión	
	63,000 - 319,999	≥ IT7	HPR 400 400 plus	<p>El inserto se puede sustituir in situ fácilmente mediante insertos intercambiables. Esto da lugar a tiempos de equipamiento muy cortos.</p>	63,000 - 319,999	HPR 400 400 plus	Expert LINE

*El rango de diámetros puede variar según la serie.

Paso 1:
Diseño



Paso 2:
Características del
agujero



Paso 3:
Clase de productos



Paso 4:
Idoneidad del
material



Paso 5:
Tipo de agujero



	Idoneidad del material														Tipo de agujero						Producto								
	P							M	K					N		C			S	H		Rango de diámetros (configurable)	Página						
	1	2	3.1	3.2	3.3	4	5	6	1-3	1	2.1	2.2	2.3	3	1-2	N3	1.1	1.2	1.3	1-5	1			2					
	■	■	■	■	■	■	■	■	■	■	■	■	■	■		■	■	■	■			■	■			2,800-20,200*	316		
	■	■	■	■	■	■	■	■	■	■	■	■	■	■		■	■	■	■	■	■		■						
														■						■	■	■							
	■	■	■	■	■	■	■		■	■	■	■	■												■				
														■	■								■			7,700-40,200	350		
	■	■	■	■	■	■	■		■	■	■	■	■	■	■								■						
																							■						
	■	■	■	■					■	■													■			3,850-8,200	350		
	■	■	■	■					■	■													■						
	■	■	■	■	■	■	■	■	■	■	■	■	■	■					■			■	■			7,000-65,000	368		
	■	■	■	■	■	■	■	■	■	■	■	■	■	■					■			■	■						
	■	■	■	■	■	■	■	■	■	■	■	■	■	■									■	■			63,000-319,999	562	

VISTA GENERAL DE LOS PRODUCTOS

FixReam: FXR500 | FXR510 | FXR505 | FXR503

Las series de escariadores de alto rendimiento FXR fabricados íntegramente en metal duro cubren una amplia gama de aplicaciones. En función del diámetro, los escariadores de alto rendimiento FixReam disponen de entre cuatro y ocho insertos con refrigeración interna, lo que les permite alcanzar elevadas velocidades de avance. Gracias a los diferentes materiales de corte y recubrimientos, es posible mecanizar numerosos materiales con rentabilidad y seguridad de proceso en un rango de diámetro de 2,850 a 20,200 mm* sin necesidad de ajuste en el rango de tolerancias IT7.

Cuando el espacio es limitado, por ejemplo, en los tornos automáticos, entran en juego las ejecuciones cortas «short».



FixReam



FixReam | FXR500 fabricado íntegramente en metal duro

Escariadores de alto rendimiento con ranuras rectas, con refrigeración interna, fabricados en metal duro. Como serie preferente en H7.

Serie preferente rango de Ø: 3,701 – 20,200 mm*



FixReam | FXR510 fabricado íntegramente en metal duro

Escariadores de alto rendimiento con ranuras oblicuas a la izquierda, con refrigeración interna, fabricados en metal duro. Como serie preferente en H7.

Serie preferente rango de Ø: 2,800 – 20,200 mm*





FixReam | FXR505 fabricado íntegramente en metal duro

Escariadores de alto rendimiento con ranuras rectas, con refrigeración interna, fabricados en metal duro. Como serie preferente en H7.

Serie preferente rango de Ø: 2,800 – 20,200 mm*



FixReam | FXR503-short fabricado íntegramente en metal duro

Escariador extra corto de alto rendimiento de metal duro, especialmente diseñado para el empleo en tornos automáticos. Como serie preferente en H7.

Serie preferente rango de Ø: 2,800 – 20,100 mm*



Visión general de la selección FixReam (1/2)

Clase de productos	Tipo de agujero	Idoneidad del material												
		P				M	K	N			C	S	H	
		1-3	4	5	6	1-3	1-3	1	2	4	1	1-5	1	2
Performance TUNE		■	■	■	■		■							
			■		■	■								
								■						
								■	■	■				
											■			
												■		■
		■	■	■	■		■							
		■	■	■	■		■							
			■		■	■								
								■						
								■	■	■				
											■			■

Ejemplo de pedido:

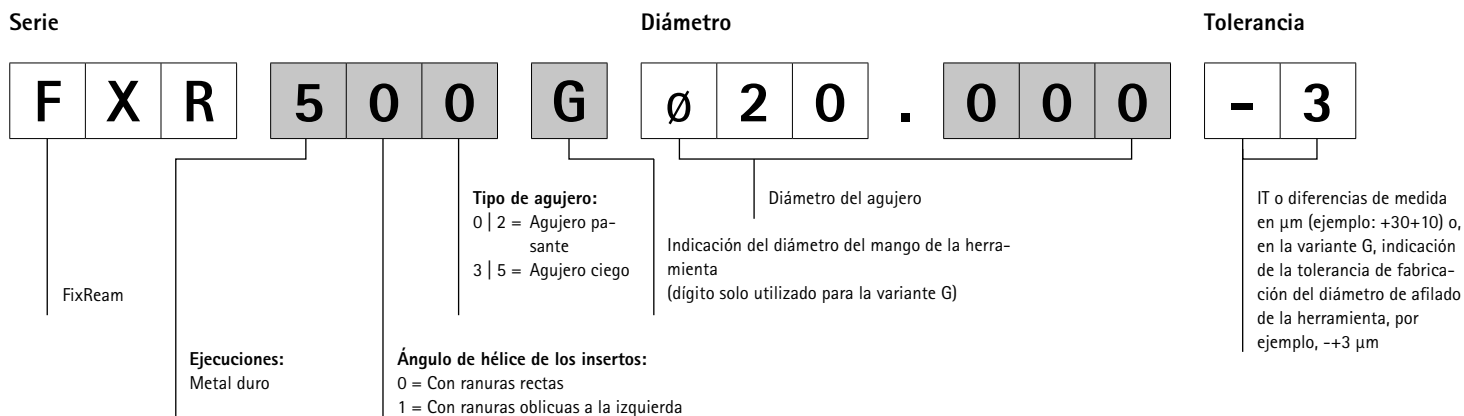

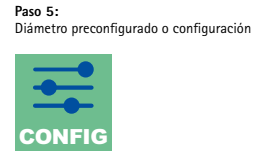

d1	Ejecución				Diámetro preconfigurado		Configuración
	Material de corte	Entrada			Serie	Página	
2,800-20,200	HP145	MG1M			FXR510	322	FXR510 Ejecución fija, con ranuras oblicuas a la izquierda, para agujeros pasantes
3,701-20,200	HP145	MF1M			FXR510	326	
3,701-20,200	HP622	MG0A			FXR500	330	
2,800-20,200	HU612	MG1M			FXR510	324	FXR500 Ejecución fija, con ranuras rectas, para agujeros pasantes
3,701-20,200	HC614	MF1M			FXR510	329	
3,701-20,200	HP625	MF1M			FXR510	328	
3,701-20,200	HP141	MFOA			FXR500	331	
2,800-20,200	HP145	MVOA			FXR505	332	
2,800-20,100	HP145	MC1F			FXR503	342	FXR505 Ejecución fija, con ranuras rectas, para agujeros ciegos
3,701-20,200	HP145	MT0A			FXR505	334	
3,701-20,200	HP622	MVOA			FXR505	335	
2,800-20,200	HU612	MVOA			FXR505	336	
3,701-20,200	HC614	MVOA			FXR505	339	
3,701-20,200	HP625	MT0A			FXR505	338	
3,701-20,200	HP141	MT0A			FXR505	340	FXR503-short Ejecución fija, con ranuras rectas, para agujeros ciegos

La configuración de la serie continúa en la página siguiente.

Entrada [Lead]

Material de corte [Cut]

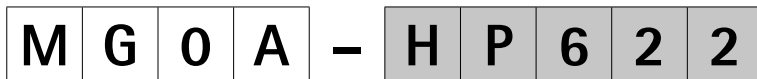

Forma de entrada y ángulo de desprendimiento:
 MGOA MT0A Para la explicación de las geometrías de entrada, véase la página 752
 MG1M MFOA
 MF1M MC1F
 MVOA

Material de corte:
 HP145 HP141
 HU612 HP625
 HP622
 HC614

Visión general de la selección FixReam | Configuración (2/2)

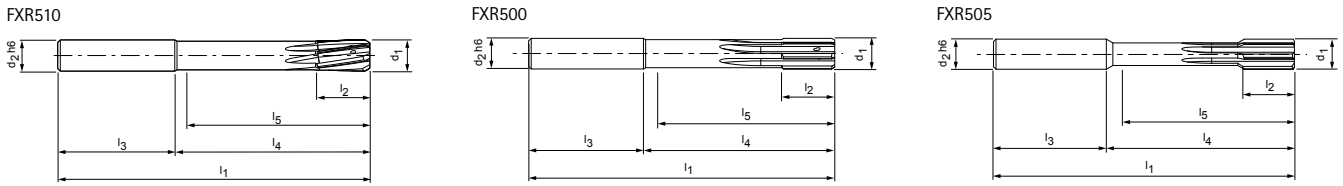

Dimensiones de la herramienta

FXR510

d ₁	d ₂	l ₁	l ₂	l ₃	l ₄	l ₅	z
2,800 - 3,700	4	65	12	28	37	34	4
3,701 - 4,700	6	75	12	36	39	34	4
4,701 - 6,200	6	75	12	36	39	35	4
6,201 - 7,200	8	100	16	36	64	59	6
7,201 - 8,200	8	100	16	36	64	60	6
8,201 - 9,200	10	100	20	40	60	55	6
9,201 - 10,200	10	120	20	40	80	76	6
10,201 - 11,200	12	120	20	45	75	70	6
11,201 - 12,200	12	120	20	45	75	71	6
12,201 - 14,200	14	130	22	45	85	80	6
14,201 - 15,200	16	130	22	48	82	77	6
15,201 - 16,200	16	150	25	48	102	97	6
16,201 - 18,200	18	150	25	48	102	97	8
18,201 - 20,200	20	150	25	50	100	95	8

FXR505

d ₁	d ₂	l ₁	l ₂	l ₃	l ₄	l ₅	z
2,800 - 3,350	4	65	12	37	28	33	4
3,351 - 3,700	4	65	12	28	37	33	4
3,701 - 6,200	6	75	12	36	39	34	4
6,201 - 8,200	8	100	16	36	64	58	6
8,201 - 9,200	10	100	20	40	60	54	6
9,201 - 10,200	10	120	20	40	80	74	6
10,201 - 12,200	12	120	20	45	75	68	6
12,201 - 14,200	14	130	22	45	85	78	6
14,201 - 15,200	16	130	22	48	82	75	6
15,201 - 16,200	16	150	25	48	102	95	6
16,201 - 18,200	18	150	25	48	102	95	6
18,201 - 20,200	20	150	25	50	100	92	6

Tolerancias para la variante G/variante fija FXR5XX

Material de corte	Rango de diámetros
	Ø2,800 - 20,200
Sin recubrimiento	-0,003
HU612	
Recubrimiento (grosor de la capa 0,8 - 2 µm)	-0,004
HP145	
HP625	
HP622	
HC614	
Recubrimiento (grosor de la capa 2 - 4 µm)	-0,005
HP141	

Explicación de la variante G FXR

Tolerancias permitidas de la pieza para la selección del diámetro de la herramienta

Ejecución variante G

La variante G indica el diámetro de la herramienta del escariador con nuestras tolerancias de fabricación. Las tolerancias de fabricación dependen del material de corte, véanse las tolerancias mínimas permitidas para la variante G.

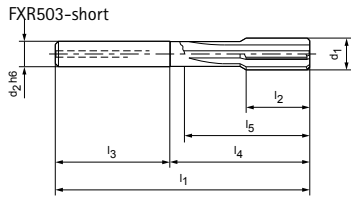

FXR500

d_1	d_2	l_1	l_2	l_3	l_4	l_5	z
3,701 - 4,700	6	75	12	36	39	34	4
4,701 - 6,200	6	75	12	36	39	35	4
6,201 - 7,200	8	100	16	36	64	59	6
7,201 - 8,200	8	100	16	36	64	60	6
8,201 - 9,200	10	100	20	40	60	55	6
9,201 - 10,200	10	120	20	40	80	76	6
10,201 - 11,200	12	120	20	45	75	70	6
11,201 - 12,200	12	120	20	45	75	71	6
12,201 - 14,200	14	130	22	45	85	80	6
14,201 - 15,200	16	130	22	48	82	77	6
15,201 - 16,200	16	150	25	48	102	97	6
16,201 - 18,200	18	150	25	48	102	97	8
18,201 - 20,200	20	150	25	50	100	95	8

FXR503-short

d_1	d_2	l_1	l_2	l_3	l_4	l_5	z
2,800 - 4,050	4	56	12	28	28	24	4
4,051 - 5,100	6	64	12	36	28	23	4
5,101 - 5,600	6	64	12	36	28	24	4
6,101 - 6,600	8	75	16	36	39	32	6
6,601 - 7,100	8	75	16	36	39	34	6
7,101 - 8,100	8	75	16	36	39	35	6
8,101 - 10,100	8	75	20	36	39	35	6
10,101 - 11,600	10	80	20	40	40	35	6
11,601 - 13,100	12	90	22	45	45	40	6
13,101 - 15,100	14	90	22	45	45	40	6
15,101 - 18,100	16	100	25	48	52	47	8
18,101 - 20,100	18	100	25	48	52	47	8



Posibilidad de soluciones especiales personalizadas para el mecanizado en varias etapas.

FixReam

Ejecución fija, con ranuras oblicuas a la izquierda, para agujeros pasantes
FXR510

Ejecución:

Diámetro del escariador: 2,800 - 20,200 mm

Entrada: MG1M

Material de corte:

HP145
Metal duro con recubrimiento de PVD

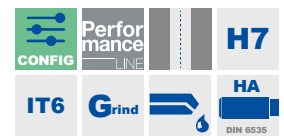
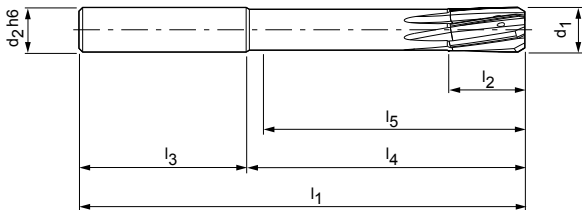

Serie preferente disponible en stock en H7

d ₁ H7	Dimensiones						z	Especificación	Referencia
	d ₂ h6	l ₁	l ₂	l ₃	l ₄	l ₅			
4,000	6	75	12	36	39	34	4	FXR510Ø4.000H7MG1M-HP145	30570722
5,000	6	75	12	36	39	35	4	FXR510Ø5.000H7MG1M-HP145	30570724
6,000	6	75	12	36	39	35	4	FXR510Ø6.000H7MG1M-HP145	30570726
7,000	8	100	16	36	64	59	6	FXR510Ø7.000H7MG1M-HP145	30570728
8,000	8	100	16	36	64	60	6	FXR510Ø8.000H7MG1M-HP145	30570730
9,000	10	100	20	40	60	55	6	FXR510Ø9.000H7MG1M-HP145	30570732
10,000	10	120	20	40	80	76	6	FXR510Ø10.000H7MG1M-HP145	30570734
11,000	12	120	20	45	75	70	6	FXR510Ø11.000H7MG1M-HP145	30570736
12,000	12	120	20	45	75	71	6	FXR510Ø12.000H7MG1M-HP145	30570738
13,000	14	130	22	45	85	80	6	FXR510Ø13.000H7MG1M-HP145	30570739
14,000	14	130	22	45	85	80	6	FXR510Ø14.000H7MG1M-HP145	30570740
15,000	16	130	22	48	82	77	6	FXR510Ø15.000H7MG1M-HP145	30570741
16,000	16	150	25	48	102	97	6	FXR510Ø16.000H7MG1M-HP145	30570742
17,000	18	150	25	48	102	97	8	FXR510Ø17.000H7MG1M-HP145	30570743
18,000	18	150	25	48	102	97	8	FXR510Ø18.000H7MG1M-HP145	30570744
19,000	20	150	25	50	100	95	8	FXR510Ø19.000H7MG1M-HP145	30570745

Medidas en mm.

Para la recomendación de valores de corte, véase al final del capítulo.

FXR510 | Ejecución fija, con ranuras oblicuas a la izquierda

Características configurables

**Tolerancia del diámetro del agujero \geq IT6**

- Diámetro seleccionable libremente en incrementos de 0,001 mm
- Se puede pedir en tolerancia \geq IT6

**Especificación**

FXR510Ø[diámetro][tolerancia]MG1M-HP145

Variante G

- Diámetro seleccionable libremente en incrementos de 0,001 mm
- Se puede pedir a partir de la tolerancia $\geq 4 \mu\text{m}$ (para la variante G, véase la página 320)

Especificación de la variante G:

FXR510GØ[diámetro][tolerancia]MG1M-HP145

Dimensiones de la serie configurable IT6

d_1	d_2	l_1	l_2	l_3	l_4	l_5	z
2,800 - 3,700	4	65	12	28	37	34	4
3,701 - 4,700	6	75	12	36	39	34	4
4,701 - 6,200	6	75	12	36	39	35	4
6,201 - 7,200	8	100	16	36	64	59	6
7,201 - 8,200	8	100	16	36	64	60	6
8,201 - 9,200	10	100	20	40	60	55	6
9,201 - 10,200	10	120	20	40	80	76	6
10,201 - 11,200	12	120	20	45	75	70	6
11,201 - 12,200	12	120	20	45	75	71	6
12,201 - 14,200	14	130	22	45	85	80	6
14,201 - 15,200	16	130	22	48	82	77	6
15,201 - 16,200	16	150	25	48	102	97	6
16,201 - 18,200	18	150	25	48	102	97	8
18,201 - 20,200	20	150	25	50	100	95	8

Ejemplo de tolerancia IT6:

FXR510Ø16.350H6MG1M-HP145

Diámetro del agujero $d_1 = 16,350 \text{ H6}$ **Ejemplo de variante G:**

FXR510GØ16.350-4MG1M-HP145

Diámetro especial de la herramienta $d_1 = 16.350 -4 \mu\text{m}$

FixReam

Ejecución fija, con ranuras oblicuas a la izquierda, para agujeros pasantes
FXR510

Ejecución:

Diámetro del escariador: 2,800 - 20,200 mm
Entrada: MG1M
Material de corte: HU612
Metal duro sin recubrimiento

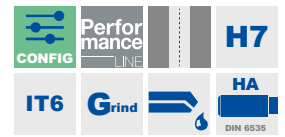
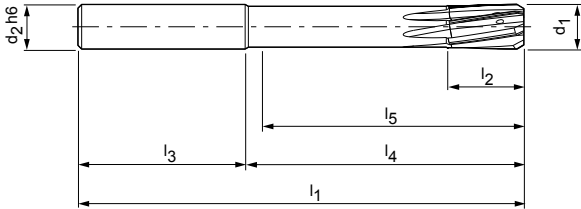

Serie preferente disponible en stock en H7

d1 H7	Dimensiones						z	Especificación	Referencia
	d2 h6	l1	l2	l3	l4	l5			
4,000	6	75	12	36	39	34	4	FXR510Ø4.000H7MG1M-HU612	30570665
5,000	6	75	12	36	39	35	4	FXR510Ø5.000H7MG1M-HU612	30570667
6,000	6	75	12	36	39	35	4	FXR510Ø6.000H7MG1M-HU612	30570669
7,000	8	100	16	36	64	59	6	FXR510Ø7.000H7MG1M-HU612	30570671
8,000	8	100	16	36	64	60	6	FXR510Ø8.000H7MG1M-HU612	30570673
9,000	10	100	20	40	60	55	6	FXR510Ø9.000H7MG1M-HU612	30570675
10,000	10	120	20	40	80	76	6	FXR510Ø10.000H7MG1M-HU612	30570677
11,000	12	120	20	45	75	70	6	FXR510Ø11.000H7MG1M-HU612	30570679
12,000	12	120	20	45	75	71	6	FXR510Ø12.000H7MG1M-HU612	30570682
13,000	14	130	22	45	85	80	6	FXR510Ø13.000H7MG1M-HU612	30570683
14,000	14	130	22	45	85	80	6	FXR510Ø14.000H7MG1M-HU612	30570684
15,000	16	130	22	48	82	77	6	FXR510Ø15.000H7MG1M-HU612	30570685
16,000	16	150	25	48	102	97	6	FXR510Ø16.000H7MG1M-HU612	30570686
17,000	18	150	25	48	102	97	8	FXR510Ø17.000H7MG1M-HU612	30570687
18,000	18	150	25	48	102	97	8	FXR510Ø18.000H7MG1M-HU612	30570688

Medidas en mm.

Para la recomendación de valores de corte, véase al final del capítulo.

FXR510 | Ejecución fija, con ranuras oblicuas a la izquierda

Características configurables

**Tolerancia del diámetro del agujero \geq IT6**

- Diámetro seleccionable libremente en incrementos de 0,001 mm
- Se puede pedir en tolerancia \geq IT6

**Especificación**

FXR510Ø[diámetro][tolerancia]MG1M-HU612

Variante G

- Diámetro seleccionable libremente en incrementos de 0,001 mm
- Se puede pedir a partir de la tolerancia $\geq 3 \mu\text{m}$ (para la variante G, véase la página 320)

Especificación de la variante G:

FXR510GØ[diámetro][tolerancia]MG1M-HU612

Dimensiones de la serie configurable IT6

d_1	d_2	l_1	l_2	l_3	l_4	l_5	z
2,800 - 3,700	4	65	12	28	37	34	4
3,701 - 4,700	6	75	12	36	39	34	4
4,701 - 6,200	6	75	12	36	39	35	4
6,201 - 7,200	8	100	16	36	64	59	6
7,201 - 8,200	8	100	16	36	64	60	6
8,201 - 9,200	10	100	20	40	60	55	6
9,201 - 10,200	10	120	20	40	80	76	6
10,201 - 11,200	12	120	20	45	75	70	6
11,201 - 12,200	12	120	20	45	75	71	6
12,201 - 14,200	14	130	22	45	85	80	6
14,201 - 15,200	16	130	22	48	82	77	6
15,201 - 16,200	16	150	25	48	102	97	6
16,201 - 18,200	18	150	25	48	102	97	8
18,201 - 20,200	20	150	25	50	100	95	8

Ejemplo de tolerancia IT6:

FXR510Ø16.350H6MG1M-HU612

Diámetro del agujero $d_1 = 16,350 \text{ H6}$ **Ejemplo de variante G:**

FXR510GØ16.350-3MG1M-HU612

Diámetro especial de la herramienta $d_1 = 16,350 -3 \mu\text{m}$

FixReam

Ejecución fija, con ranuras oblicuas a la izquierda, para agujeros pasantes
FXR510

Ejecución:

Diámetro del escariador: 3,701 - 20,200 mm

Entrada: MF1M

Material de corte: HP145

Metal duro con recubrimiento de PVD

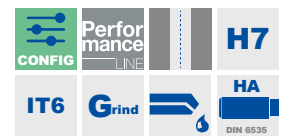
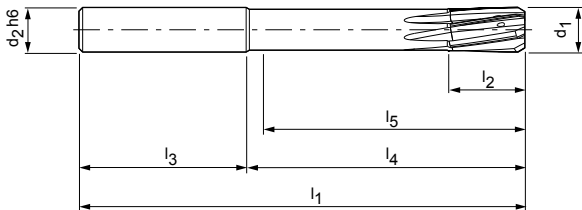

Serie preferente disponible en stock en H7

d ₁ H7	Dimensiones						z	Especificación	Referencia
	d ₂ h6	l ₁	l ₂	l ₃	l ₄	l ₅			
4,000	6	75	12	36	39	35	4	FXR510Ø4.000H7MF1M-HP145	30570772
5,000	6	75	12	36	39	35	4	FXR510Ø5.000H7MF1M-HP145	30570774
6,000	6	75	12	36	39	35	4	FXR510Ø6.000H7MF1M-HP145	30570776
7,000	8	100	16	36	64	59	6	FXR510Ø7.000H7MF1M-HP145	30570778
8,000	8	100	16	36	64	60	6	FXR510Ø8.000H7MF1M-HP145	30570780
10,000	10	120	20	40	80	76	6	FXR510Ø10.000H7MF1M-HP145	30570784
11,000	12	120	20	45	75	70	6	FXR510Ø11.000H7MF1M-HP145	30570786
12,000	12	120	20	45	75	71	6	FXR510Ø12.000H7MF1M-HP145	30570788
14,000	14	130	22	45	85	80	6	FXR510Ø14.000H7MF1M-HP145	30570790
16,000	16	150	25	48	102	97	6	FXR510Ø16.000H7MF1M-HP145	30570792

Medidas en mm.

Para la recomendación de valores de corte, véase al final del capítulo.

FXR510 | Ejecución fija, con ranuras oblicuas a la izquierda

Características configurables

**Tolerancia del diámetro del agujero \geq IT6**

- Diámetro seleccionable libremente en incrementos de 0,001 mm
- Se puede pedir en tolerancia \geq IT6

Especificación

FXR510Ø[diámetro][tolerancia]MF1M-HP145

Variante G

- Diámetro seleccionable libremente en incrementos de 0,001 mm
- Se puede pedir a partir de la tolerancia $\geq 4 \mu\text{m}$ (para la variante G, véase la página 320)

Especificación de la variante G:

FXR510GØ[diámetro][tolerancia]MF1M-HP145

Dimensiones de la serie configurable IT6

d_1	d_2	l_1	l_2	l_3	l_4	l_5	z
3,701 - 4,700	6	75	12	36	39	34	4
4,701 - 6,200	6	75	12	36	39	35	4
6,201 - 7,200	8	100	16	36	64	59	6
7,201 - 8,200	8	100	16	36	64	60	6
8,201 - 9,200	10	100	20	40	60	55	6
9,201 - 10,200	10	120	20	40	80	76	6
10,201 - 11,200	12	120	20	45	75	70	6
11,201 - 12,200	12	120	20	45	75	71	6
12,201 - 14,200	14	130	22	45	85	80	6
14,201 - 15,200	16	130	22	48	82	77	6
15,201 - 16,200	16	150	25	48	102	97	6
16,201 - 18,200	18	150	25	48	102	97	8
18,201 - 20,200	20	150	25	50	100	95	8

Ejemplo de tolerancia IT6:

FXR510Ø16.350H6MF1M-HP145

Diámetro del agujero $d_1 = 16,350 \text{ H6}$ **Ejemplo de variante G:**

FXR510GØ16.350-4MF1M-HP145

Diámetro especial de la herramienta $d_1 = 16.350 -4 \mu\text{m}$

FixReam

Ejecución fija, con ranuras oblicuas a la izquierda, para agujeros pasantes
FXR510

Ejecución:

Diámetro del escariador: 3,701 - 20,200 mm

Entrada: MF1M

Material de corte:

HP625
Metal duro con recubrimiento de PVD

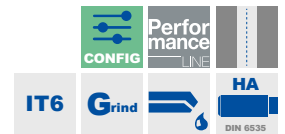
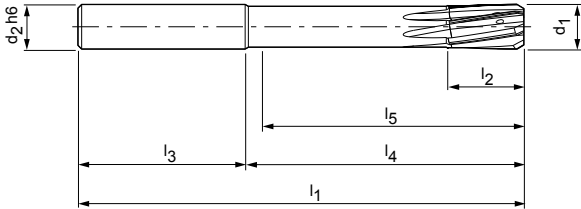

Características configurables



Tolerancia del diámetro del agujero ≥ IT6
- Diámetro seleccionable libremente en incrementos de 0,001 mm
- Se puede pedir en tolerancia ≥ IT6

Especificación
FXR510Ø[diámetro][tolerancia]MF1M-HP625

Variante G
- Diámetro seleccionable libremente en incrementos de 0,001 mm
- Se puede pedir a partir de la tolerancia ≥ 4 µm (para la variante G, véase la página 320)

Especificación de la variante G:
FXR510GØ[diámetro][tolerancia]MF1M-HP625

Dimensiones de la serie configurable IT6

d ₁	d ₂	l ₁	l ₂	l ₃	l ₄	l ₅	z
3,701 - 4,700	6	75	12	36	39	34	4
4,701 - 6,200	6	75	12	36	39	35	4
6,201 - 7,200	8	100	16	36	64	59	6
7,201 - 8,200	8	100	16	36	64	60	6
8,201 - 9,200	10	100	20	40	60	55	6
9,201 - 10,200	10	120	20	40	80	76	6
10,201 - 11,200	12	120	20	45	75	70	6
11,201 - 12,200	12	120	20	45	75	71	6
12,201 - 14,200	14	130	22	45	85	80	6
14,201 - 15,200	16	130	22	48	82	77	6
15,201 - 16,200	16	150	25	48	102	97	6
16,201 - 18,200	18	150	25	48	102	97	8
18,201 - 20,200	20	150	25	50	100	95	8

Ejemplo de tolerancia IT6:
FXR510Ø16.350H6MF1M-HP625

Diámetro del agujero d₁ = 16,350 H6

Ejemplo de variante G:
FXR510GØ16.350-4MF1M-HP625

Diámetro especial de la herramienta d₁ = 16.350 -4 µm

Medidas en mm.
Para la recomendación de valores de corte, véase al final del capítulo.

FixReam

Ejecución fija, con ranuras oblicuas a la izquierda, para agujeros pasantes
FXR510

Ejecución:

Diámetro del escariador: 3,701 - 20,200 mm

Entrada: MF1M

Material de corte:

HC614
Metal duro con recubrimiento CVD

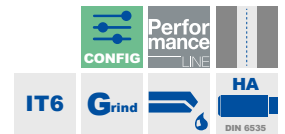
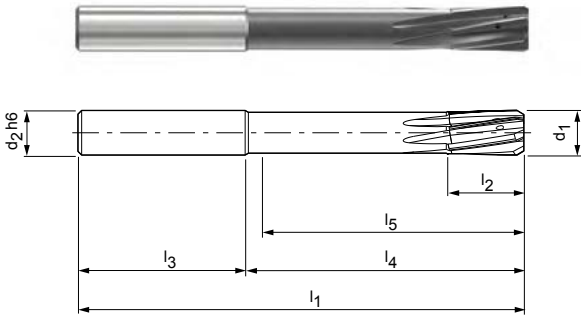

Características configurables



Tolerancia del diámetro del agujero \geq IT6

- Diámetro seleccionable libremente en incrementos de 0,001 mm
- Se puede pedir en tolerancia \geq IT6

Especificación

FXR510Ø[diámetro][tolerancia]MF1M-HC614

Variante G

- Diámetro seleccionable libremente en incrementos de 0,001 mm
- Se puede pedir a partir de la tolerancia $\geq 4 \mu\text{m}$ (para la variante G, véase la página 320)

Especificación de la variante G:

FXR510GØ[diámetro][tolerancia]MF1M-HC614

Dimensiones de la serie configurable IT6

d_1	d_2	l_1	l_2	l_3	l_4	l_5	z
3,701 - 4,700	6	75	12	36	39	34	4
4,701 - 6,200	6	75	12	36	39	35	4
6,201 - 7,200	8	100	16	36	64	59	6
7,201 - 8,200	8	100	16	36	64	60	6
8,201 - 9,200	10	100	20	40	60	55	6
9,201 - 10,200	10	120	20	40	80	76	6
10,201 - 11,200	12	120	20	45	75	70	6
11,201 - 12,200	12	120	20	45	75	71	6
12,201 - 14,200	14	130	22	45	85	80	6
14,201 - 15,200	16	130	22	48	82	77	6
15,201 - 16,200	16	150	25	48	102	97	6
16,201 - 18,200	18	150	25	48	102	97	8
18,201 - 20,200	20	150	25	50	100	95	8

Ejemplo de tolerancia IT6:

FXR510Ø16.350H6MF1M-HC614

Diámetro del agujero $d_1 = 16,350 \text{ H6}$

Ejemplo de variante G:

FXR510GØ16.350-4MF1M-HC614

Diámetro especial de la herramienta $d_1 = 16.350 -4 \mu\text{m}$

Medidas en mm.

Para la recomendación de valores de corte, véase al final del capítulo.

FixReam

Ejecución fija, con ranuras rectas, para agujero pasante
FXR500

Ejecución:

Diámetro del escariador: 3,701 - 20,200 mm

Entrada: MG0A

Material de corte: HP622
Metal duro con recubrimiento de PVD

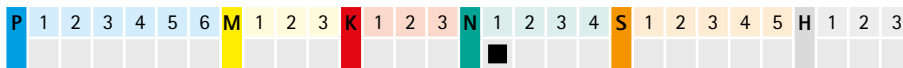
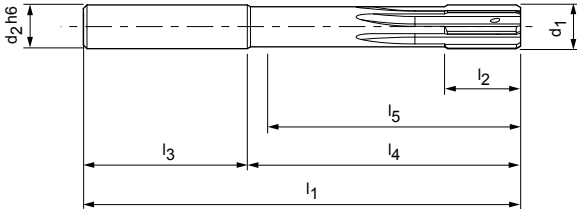

Características configurables



Tolerancia del diámetro del agujero ≥ IT6
- Diámetro seleccionable libremente en incrementos de 0,001 mm
- Se puede pedir en tolerancia ≥ IT6

Especificación
FXR500Ø[diámetro][tolerancia]MG0A-HP622

Variante G
- Diámetro seleccionable libremente en incrementos de 0,001 mm
- Se puede pedir a partir de la tolerancia ≥ 4 µm (para la variante G, véase la página 320)

Especificación de la variante G:
FXR500GØ[diámetro][tolerancia]MG0A-HP622

Dimensiones de la serie configurable IT6

d ₁	d ₂	l ₁	l ₂	l ₃	l ₄	l ₅	z
3,701 - 4,700	6	75	12	36	39	34	4
4,701 - 6,200	6	75	12	36	39	35	4
6,201 - 7,200	8	100	16	36	64	59	6
7,201 - 8,200	8	100	16	36	64	60	6
8,201 - 9,200	10	100	20	40	60	55	6
9,201 - 10,200	10	120	20	40	80	76	6
10,201 - 11,200	12	120	20	45	75	70	6
11,201 - 12,200	12	120	20	45	75	71	6
12,201 - 14,200	14	130	22	45	85	80	6
14,201 - 15,200	16	130	22	48	82	77	6
15,201 - 16,200	16	150	25	48	102	97	6
16,201 - 18,200	18	150	25	48	102	97	8
18,201 - 20,200	20	150	25	50	100	95	8

Ejemplo de tolerancia IT6:
FXR500Ø16.350H6MG0A-HP622

Diámetro del agujero d₁ = 16,350 H6

Ejemplo de variante G:
FXR500GØ16.350-4MG0A-HP622

Diámetro especial de la herramienta d₁ = 16.350 -4 µm

FixReam

Ejecución fija, con ranuras rectas, para agujero pasante
FXR500

Ejecución:

Diámetro del escariador: 3,701 - 20,200 mm

Entrada: HP141

Material de corte:

Metal duro con recubrimiento de PVD

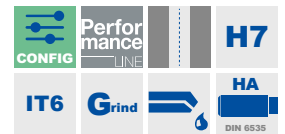
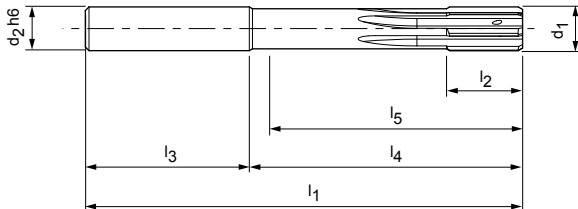

Serie preferente disponible en stock en H7

d ₁ H7	Dimensiones						z	Especificación	Referencia
	d ₂ h6	l ₁	l ₂	l ₃	l ₄	l ₅			
5,000	6	75	12	36	39	35	4	FXR500Ø5.000H7MFOA-HP141	30570824
6,000	6	75	12	36	39	35	4	FXR500Ø6.000H7MFOA-HP141	30570826
8,000	8	100	16	36	64	60	6	FXR500Ø8.000H7MFOA-HP141	30570830
10,000	10	120	20	40	80	76	6	FXR500Ø10.000H7MFOA-HP141	30570834
12,000	12	120	20	45	75	71	6	FXR500Ø12.000H7MFOA-HP141	30570838

Características configurables



Tolerancia del diámetro del agujero ≥ IT6

- Diámetro seleccionable libremente en incrementos de 0,001 mm
- Se puede pedir en tolerancia ≥ IT6

Especificación

FXR500Ø[diámetro][tolerancia]MFOA-HP141

Variante G

- Diámetro seleccionable libremente en incrementos de 0,001 mm
- Se puede pedir a partir de la tolerancia ≥ 5 μm (para la variante G, véase la página 320)

Especificación de la variante G:

FXR500GØ[diámetro][tolerancia]MFOA-HP141

Dimensiones de la serie configurable IT6

d ₁	d ₂	l ₁	l ₂	l ₃	l ₄	l ₅	z
3,701 - 4,700	6	75	12	36	39	34	4
4,701 - 6,200	6	75	12	36	39	35	4
6,201 - 7,200	8	100	16	36	64	59	6
7,201 - 8,200	8	100	16	36	64	60	6
8,201 - 9,200	10	100	20	40	60	55	6
9,201 - 10,200	10	120	20	40	80	76	6
10,201 - 11,200	12	120	20	45	75	70	6
11,201 - 12,200	12	120	20	45	75	71	6
12,201 - 14,200	14	130	22	45	85	80	6
14,201 - 15,200	16	130	22	48	82	77	6
15,201 - 16,200	16	150	25	48	102	97	6
16,201 - 18,200	18	150	25	48	102	97	8
18,201 - 20,200	20	150	25	50	100	95	8

Ejemplo de tolerancia IT6:

FXR500Ø16.350H6MFOA-HP141

Diámetro del agujero d₁ = 16,350 H6

Ejemplo de variante G:

FXR500GØ16.350-5MFOA-HP141

Diámetro especial de la herramienta d₁ = 16,350 -5 μm

Medidas en mm.

Para la recomendación de valores de corte, véase al final del capítulo.

FixReam

Ejecución fija, con ranuras rectas, para agujeros ciegos
FXR505

Ejecución:
 Diámetro del escariador: 2,800 - 20,200 mm
 Entrada: MV0A
 Material de corte: HP145
 Metal duro con recubrimiento de PVD

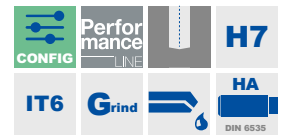
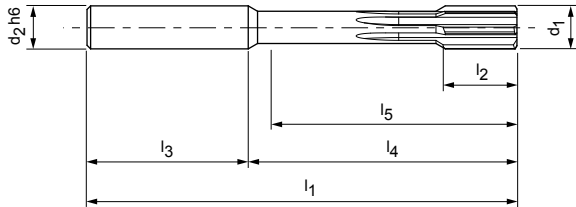

Serie preferente disponible en stock en H7

d ₁ H7	Dimensiones						z	Especificación	Referencia
	d ₂ h6	l ₁	l ₂	l ₃	l ₄	l ₅			
4,000	6	75	12	36	39	34	4	FXR505Ø4.000H7MV0A-HP145	30570747
5,000	6	75	12	36	39	34	4	FXR505Ø5.000H7MV0A-HP145	30570749
6,000	6	75	12	36	39	34	4	FXR505Ø6.000H7MV0A-HP145	30570751
7,000	8	100	16	36	64	58	6	FXR505Ø7.000H7MV0A-HP145	30570753
8,000	8	100	16	36	64	58	6	FXR505Ø8.000H7MV0A-HP145	30570755
9,000	10	100	20	40	60	54	6	FXR505Ø9.000H7MV0A-HP145	30570757
10,000	10	120	20	40	80	74	6	FXR505Ø10.000H7MV0A-HP145	30570759
11,000	12	120	20	45	75	68	6	FXR505Ø11.000H7MV0A-HP145	30570761
12,000	12	120	20	45	75	68	6	FXR505Ø12.000H7MV0A-HP145	30570763
13,000	14	130	22	45	85	78	6	FXR505Ø13.000H7MV0A-HP145	30570764
14,000	14	130	22	45	85	78	6	FXR505Ø14.000H7MV0A-HP145	30570765
15,000	16	130	22	48	82	75	6	FXR505Ø15.000H7MV0A-HP145	30570766
16,000	16	150	25	48	102	95	6	FXR505Ø16.000H7MV0A-HP145	30570767
17,000	18	150	25	48	102	95	6	FXR505Ø17.000H7MV0A-HP145	30570768
18,000	18	150	25	48	102	95	6	FXR505Ø18.000H7MV0A-HP145	30570769
19,000	20	150	25	50	100	92	6	FXR505Ø19.000H7MV0A-HP145	30570770

Medidas en mm.
 Para la recomendación de valores de corte, véase al final del capítulo.

FXR505 | Ejecución fija, con ranuras rectas

Características configurables

**Tolerancia del diámetro del agujero \geq IT6**

- Diámetro seleccionable libremente en incrementos de 0,001 mm
- Se puede pedir en tolerancia \geq IT6

Especificación

FXR505Ø[diámetro][tolerancia]MVOA-HP145

Variante G

- Diámetro seleccionable libremente en incrementos de 0,001 mm
- Se puede pedir a partir de la tolerancia $\geq 4 \mu\text{m}$ (para la variante G, véase la página 320)

Especificación de la variante G:

FXR505GØ[diámetro][tolerancia]MVOA-HP145

Dimensiones de la serie configurable IT6

d_1	d_2	l_1	l_2	l_3	l_4	l_5	z
2,800 - 3,350	4	65	12	37	28	33	4
3,351 - 3,700	4	65	12	28	37	33	4
3,701 - 6,200	6	75	12	36	39	34	4
6,201 - 8,200	8	100	16	36	64	58	6
8,201 - 9,200	10	100	20	40	60	54	6
9,201 - 10,200	10	120	20	40	80	74	6
10,201 - 12,200	12	120	20	45	75	68	6
12,201 - 14,200	14	130	22	45	85	78	6
14,201 - 15,200	16	130	22	48	82	75	6
15,201 - 16,200	16	150	25	48	102	95	6
16,201 - 18,200	18	150	25	48	102	95	6
18,201 - 20,200	20	150	25	50	100	92	6

Ejemplo de tolerancia IT6:

FXR505Ø16.350H6MVOA-HP145

Diámetro del agujero $d_1 = 16,350 \text{ H6}$ **Ejemplo de variante G:**

FXR505GØ16.350-4MVOA-HP145

Diámetro especial de la herramienta $d_1 = 16.350 -4 \mu\text{m}$

FixReam

Ejecución fija, con ranuras rectas, para agujeros ciegos
FXR505

Ejecución:

Diámetro del escariador: 3,701 - 20,200 mm

Entrada: MTOA

Material de corte:

HP145
Metal duro con recubrimiento de PVD

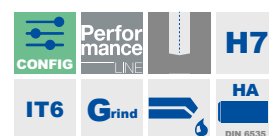
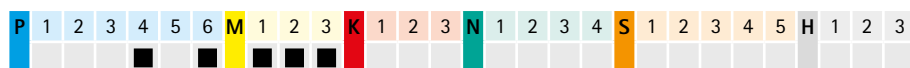
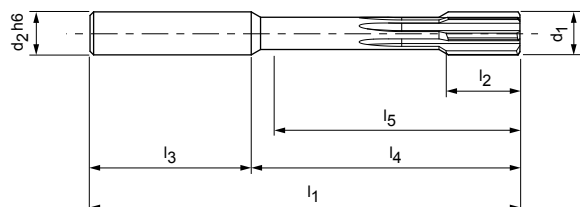

Serie preferente disponible en stock en H7

d ₁ H7	Dimensiones						z	Especificación	Referencia
	d ₂ h6	l ₁	l ₂	l ₃	l ₄	l ₅			
4,000	6	75	12	36	39	34	4	FXR505Ø4.000H7MTOA-HP145	30570797
5,000	6	75	12	36	39	34	4	FXR505Ø5.000H7MTOA-HP145	30570799
6,000	6	75	12	36	39	34	4	FXR505Ø6.000H7MTOA-HP145	30570801
8,000	8	100	16	36	64	58	6	FXR505Ø8.000H7MTOA-HP145	30570805
10,000	10	120	20	40	80	74	6	FXR505Ø10.000H7MTOA-HP145	30570809
12,000	12	120	20	45	75	68	6	FXR505Ø12.000H7MTOA-HP145	30570813

Características configurables



Tolerancia del diámetro del agujero ≥ IT6

- Diámetro seleccionable libremente en incrementos de 0,001 mm
- Se puede pedir en tolerancia ≥ IT6

Especificación

FXR505Ø[diámetro][tolerancia]MTOA-HP145

Variante G

- Diámetro seleccionable libremente en incrementos de 0,001 mm
- Se puede pedir a partir de la tolerancia ≥ 4 μm (para la variante G, véase la página 320)

Especificación de la variante G:

FXR505GØ[diámetro][tolerancia]MTOA-HP145

Dimensiones de la serie configurable IT6

d ₁	d ₂	l ₁	l ₂	l ₃	l ₄	l ₅	z
3,701 - 6,200	6	75	12	36	39	34	4
6,201 - 8,200	8	100	16	36	64	58	6
8,201 - 9,200	10	100	20	40	60	54	6
9,201 - 10,200	10	120	20	40	80	74	6
10,201 - 12,200	12	120	20	45	75	68	6
12,201 - 14,200	14	130	22	45	85	78	6
14,201 - 15,200	16	130	22	48	82	75	6
15,201 - 16,200	16	150	25	48	102	95	6
16,201 - 18,200	18	150	25	48	102	95	6
18,201 - 20,200	20	150	25	50	100	92	6

Ejemplo de tolerancia IT6:

FXR505Ø16.350H6MTOA-HP145

Diámetro del agujero d₁ = 16,350 H6

Ejemplo de variante G:

FXR505GØ16.350-4MTOA-HP145

Diámetro especial de la herramienta d₁ = 16.350 -4 μm

Medidas en mm.

Para la recomendación de valores de corte, véase al final del capítulo.

FixReam

Ejecución fija, con ranuras rectas, para agujeros ciegos
FXR505

Ejecución:

Diámetro del escariador: 3,701 - 20,200 mm

Entrada: MVOA

Material de corte: HP622

Metal duro con recubrimiento de PVD

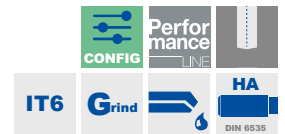
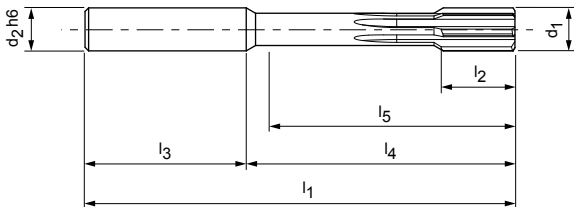

Características configurables



Tolerancia del diámetro del agujero \geq IT6
 - Diámetro seleccionable libremente en incrementos de 0,001 mm
 - Se puede pedir en tolerancia \geq IT6

Especificación
 FXR505Ø[diámetro][tolerancia]MVOA-HP622

Variante G
 - Diámetro seleccionable libremente en incrementos de 0,001 mm
 - Se puede pedir a partir de la tolerancia $\geq 4 \mu\text{m}$ (para la variante G, véase la página 320)

Especificación de la variante G:
 FXR505GØ[diámetro][tolerancia]MVOA-HP622

Dimensiones de la serie configurable IT6

d_1	d_2	l_1	l_2	l_3	l_4	l_5	z
3,701 - 6,200	6	75	12	36	39	34	4
6,201 - 8,200	8	100	16	36	64	58	6
8,201 - 9,200	10	100	20	40	60	54	6
9,201 - 10,200	10	120	20	40	80	74	6
10,201 - 12,200	12	120	20	45	75	68	6
12,201 - 14,200	14	130	22	45	85	78	6
14,201 - 15,200	16	130	22	48	82	75	6
15,201 - 16,200	16	150	25	48	102	95	6
16,201 - 18,200	18	150	25	48	102	95	6
18,201 - 20,200	20	150	25	50	100	92	6

Ejemplo de tolerancia IT6:
 FXR505Ø16.350H6MVOA-HP622

Diámetro del agujero $d_1 = 16,350 \text{ H6}$

Ejemplo de variante G:
 FXR505GØ16.350-4MVOA-HP622

Diámetro especial de la herramienta $d_1 = 16.350 -4 \mu\text{m}$

FixReam

Ejecución fija, con ranuras rectas, para agujeros ciegos
FXR505

Ejecución:

Diámetro del escariador: 2,800 - 20,200 mm
Entrada: MV0A
Material de corte: HU612
Metal duro sin recubrimiento

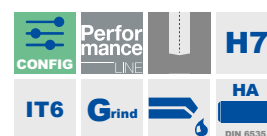
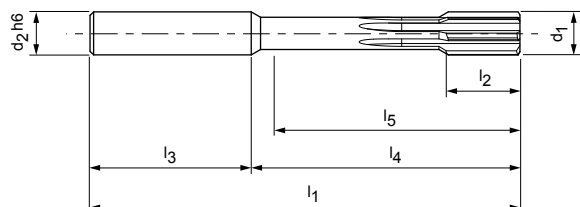

Serie preferente disponible en stock en H7

d ₁ H7	Dimensiones						z	Especificación	Referencia
	d ₂ h6	l ₁	l ₂	l ₃	l ₄	l ₅			
4,000	6	75	12	36	39	34	4	FXR505Ø4.000H7MV0A-HU612	30570694
5,000	6	75	12	36	39	34	4	FXR505Ø5.000H7MV0A-HU612	30570696
6,000	6	75	12	36	39	34	4	FXR505Ø6.000H7MV0A-HU612	30570698
7,000	8	100	16	36	64	58	6	FXR505Ø7.000H7MV0A-HU612	30570700
8,000	8	100	16	36	64	58	6	FXR505Ø8.000H7MV0A-HU612	30570702
9,000	10	100	20	40	60	54	6	FXR505Ø9.000H7MV0A-HU612	30570704
10,000	10	120	20	40	80	74	6	FXR505Ø10.000H7MV0A-HU612	30570706
12,000	12	120	20	45	75	68	6	FXR505Ø12.000H7MV0A-HU612	30570710
13,000	14	130	22	45	85	78	6	FXR505Ø13.000H7MV0A-HU612	30570711
14,000	14	130	22	45	85	78	6	FXR505Ø14.000H7MV0A-HU612	30570712
15,000	16	130	22	48	82	75	6	FXR505Ø15.000H7MV0A-HU612	30570713
16,000	16	150	25	48	102	95	6	FXR505Ø16.000H7MV0A-HU612	30570714
18,000	18	150	25	48	102	95	6	FXR505Ø18.000H7MV0A-HU612	30570716
19,000	20	150	25	50	100	92	6	FXR505Ø19.000H7MV0A-HU612	30570717

Medidas en mm.

Para la recomendación de valores de corte, véase al final del capítulo.

FXR505 | Ejecución fija, con ranuras rectas

Características configurables

**Tolerancia del diámetro del agujero \geq IT6**

- Diámetro seleccionable libremente en incrementos de 0,001 mm
- Se puede pedir en tolerancia \geq IT6

Especificación

FXR505Ø[diámetro][tolerancia]MV0A-HU612

Variante G

- Diámetro seleccionable libremente en incrementos de 0,001 mm
- Se puede pedir a partir de la tolerancia $\geq 3 \mu\text{m}$ (para la variante G, véase la página 320)

Especificación de la variante G:

FXR505GØ[diámetro][tolerancia]MV0A-HU612

Dimensiones de la serie configurable IT6

d_1	d_2	l_1	l_2	l_3	l_4	l_5	z
2,800 - 3,350	4	65	12	37	28	33	4
3,351 - 3,700	4	65	12	28	37	33	4
3,701 - 6,200	6	75	12	36	39	34	4
6,201 - 8,200	8	100	16	36	64	58	6
8,201 - 9,200	10	100	20	40	60	54	6
9,201 - 10,200	10	120	20	40	80	74	6
10,201 - 12,200	12	120	20	45	75	68	6
12,201 - 14,200	14	130	22	45	85	78	6
14,201 - 15,200	16	130	22	48	82	75	6
15,201 - 16,200	16	150	25	48	102	95	6
16,201 - 18,200	18	150	25	48	102	95	6
18,201 - 20,200	20	150	25	50	100	92	6

Ejemplo de tolerancia IT6:

FXR505Ø16.350H6MV0A-HU612

Diámetro del agujero $d_1 = 16,350 \text{ H6}$ **Ejemplo de variante G:**

FXR505GØ16.350-3MV0A-HU612

Diámetro especial de la herramienta $d_1 = 16,350 -3 \mu\text{m}$

FixReam

Ejecución fija, con ranuras rectas, para agujeros ciegos
FXR505

Ejecución:
Diámetro del escariador: 3,701 - 20,200 mm
Entrada: MT0A
Material de corte: HP625
Metal duro con recubrimiento de PVD

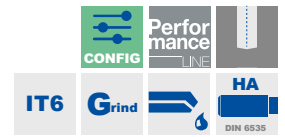
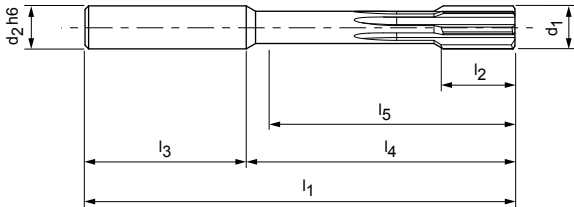

Características configurables



Tolerancia del diámetro del agujero \geq IT6
- Diámetro seleccionable libremente en incrementos de 0,001 mm
- Se puede pedir en tolerancia \geq IT6

Especificación
FXR505Ø[diámetro][tolerancia]MT0A-HP625

Variante G
- Diámetro seleccionable libremente en incrementos de 0,001 mm
- Se puede pedir a partir de la tolerancia $\geq 4 \mu\text{m}$ (para la variante G, véase la página 320)

Especificación de la variante G:
FXR505GØ[diámetro][tolerancia]MT0A-HP625

Dimensiones de la serie configurable IT6

d_1	d_2	l_1	l_2	l_3	l_4	l_5	z
3,701 - 6,200	6	75	12	36	39	34	4
6,201 - 8,200	8	100	16	36	64	58	6
8,201 - 9,200	10	100	20	40	60	54	6
9,201 - 10,200	10	120	20	40	80	74	6
10,201 - 12,200	12	120	20	45	75	68	6
12,201 - 14,200	14	130	22	45	85	78	6
14,201 - 15,200	16	130	22	48	82	75	6
15,201 - 16,200	16	150	25	48	102	95	6
16,201 - 18,200	18	150	25	48	102	95	6
18,201 - 20,200	20	150	25	50	100	92	6

Ejemplo de tolerancia IT6:
FXR505Ø16.350H6MT0A-HP625

Diámetro del agujero $d_1 = 16,350 \text{ H6}$

Ejemplo de variante G:
FXR505GØ16.350-4MT0A-HP625

Diámetro especial de la herramienta $d_1 = 16.350 -4 \mu\text{m}$

FixReam

Ejecución fija, con ranuras rectas, para agujeros ciegos
FXR505

Ejecución:

Diámetro del escariador: 3,701 - 20,200 mm

Entrada: MVOA

Material de corte:

HC614
Metal duro con recubrimiento CVD

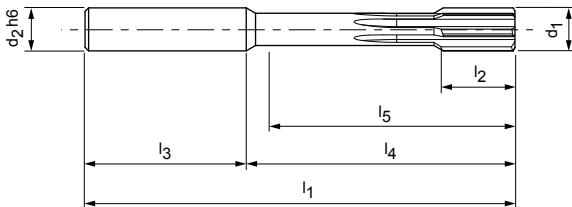

N	1.1	1.2	1.3	1.4	2.1	2.2	2.3	3.1	4.1	4.2	4.3	C	1.1	1.2	1.3	2.1	3.1	4.1	4.2	4.3	4.4	5.1	5.2
---	-----	-----	-----	-----	-----	-----	-----	-----	-----	-----	-----	---	-----	-----	-----	-----	-----	-----	-----	-----	-----	-----	-----

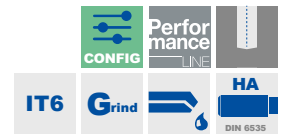

Características configurables



Tolerancia del diámetro del agujero \geq IT6

- Diámetro seleccionable libremente en incrementos de 0,001 mm
- Se puede pedir en tolerancia \geq IT6

Especificación

FXR505Ø[diámetro][tolerancia]MVOA-HC614

Variante G

- Diámetro seleccionable libremente en incrementos de 0,001 mm
- Se puede pedir a partir de la tolerancia $\geq 4 \mu\text{m}$ (para la variante G, véase la página 320)

Especificación de la variante G:

FXR505GØ[diámetro][tolerancia]MVOA-HC614

Dimensiones de la serie configurable IT6

d_1	d_2	l_1	l_2	l_3	l_4	l_5	z
3,701 - 6,200	6	75	12	36	39	34	4
6,201 - 8,200	8	100	16	36	64	58	6
8,201 - 9,200	10	100	20	40	60	54	6
9,201 - 10,200	10	120	20	40	80	74	6
10,201 - 12,200	12	120	20	45	75	68	6
12,201 - 14,200	14	130	22	45	85	78	6
14,201 - 15,200	16	130	22	48	82	75	6
15,201 - 16,200	16	150	25	48	102	95	6
16,201 - 18,200	18	150	25	48	102	95	6
18,201 - 20,200	20	150	25	50	100	92	6

Ejemplo de tolerancia IT6:

FXR505Ø16.350H6MVOA-HC614

Diámetro del agujero $d_1 = 16,350 \text{ H6}$

Ejemplo de variante G:

FXR505GØ16.350-4MVOA-HC614

Diámetro especial de la herramienta $d_1 = 16.350 -4 \mu\text{m}$

Medidas en mm.

Para la recomendación de valores de corte, véase al final del capítulo.

FixReam

Ejecución fija, con ranuras rectas, para agujeros ciegos
FXR505

Ejecución:
Diámetro del escariador: 3,701 - 20,200 mm
Entrada: MT0A
Material de corte: HP141
Metal duro con recubrimiento de PVD

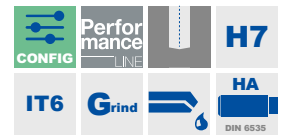
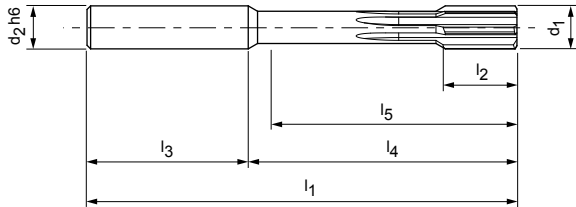

Características configurables



Tolerancia del diámetro del agujero \geq IT6
- Diámetro seleccionable libremente en incrementos de 0,001 mm
- Se puede pedir en tolerancia \geq IT6

Especificación
FXR505Ø[diámetro][tolerancia]MT0A-HP141

Variante G
- Diámetro seleccionable libremente en incrementos de 0,001 mm
- Se puede pedir a partir de la tolerancia $\geq 5 \mu\text{m}$ (para la variante G, véase la página 320)

Especificación de la variante G:
FXR505GØ[diámetro][tolerancia]MT0A-HP141

Dimensiones de la serie configurable IT6

d_1	d_2	l_1	l_2	l_3	l_4	l_5	z
3,701 - 6,200	6	75	12	36	39	34	4
6,201 - 8,200	8	100	16	36	64	58	6
8,201 - 9,200	10	100	20	40	60	54	6
9,201 - 10,200	10	120	20	40	80	74	6
10,201 - 12,200	12	120	20	45	75	68	6
12,201 - 14,200	14	130	22	45	85	78	6
14,201 - 15,200	16	130	22	48	82	75	6
15,201 - 16,200	16	150	25	48	102	95	6
16,201 - 18,200	18	150	25	48	102	95	6
18,201 - 20,200	20	150	25	50	100	92	6

Ejemplo de tolerancia IT6:
FXR505Ø16.350H6MT0A-HP141

Diámetro del agujero $d_1 = 16,350 \text{ H6}$

Ejemplo de variante G:
FXR505GØ16.350-5MT0A-HP141

Diámetro especial de la herramienta $d_1 = 16,350 -5 \mu\text{m}$

FixReam

Ejecución fija, con ranuras rectas, para agujeros ciegos
FXR503-short

Ejecución:

Diámetro del escariador: 2,800 - 20,100 mm

Entrada: MC1F

Material de corte:

HP145
Metal duro con recubrimiento de PVD

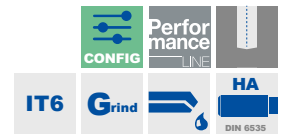
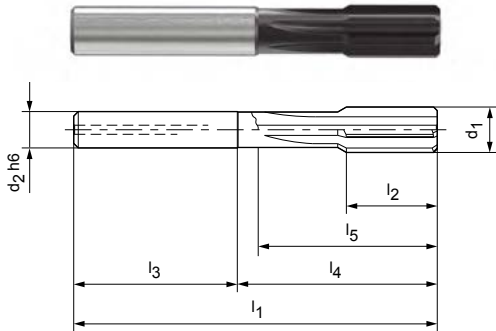

Características configurables



Tolerancia del diámetro del agujero \geq IT6

- Diámetro seleccionable libremente en incrementos de 0,001 mm
- Se puede pedir en tolerancia \geq IT6

Especificación

FXR503Ø[diámetro][tolerancia]MC1F-HP145

Variante G

- Diámetro seleccionable libremente en incrementos de 0,001 mm
- Se puede pedir a partir de la tolerancia $\geq 4 \mu\text{m}$ (para la variante G, véase la página 320)

Especificación de la variante G:

FXR503GØ[diámetro][tolerancia]MC1F-HP145

Dimensiones de la serie configurable IT6

d_1	d_2	l_1	l_2	l_3	l_4	l_5	z
2,800 - 4,050	4	56	12	28	28	24	4
4,051 - 5,100	6	64	12	36	28	23	4
5,101 - 5,600	6	64	12	36	28	24	4
6,101 - 6,600	8	75	16	36	39	32	6
6,601 - 7,100	8	75	16	36	39	34	6
7,101 - 8,100	8	75	16	36	39	35	6
8,101 - 10,100	8	75	20	36	39	35	6
10,101 - 11,600	10	80	20	40	40	35	6
11,601 - 13,100	12	90	22	45	45	40	6
13,101 - 15,100	14	90	22	45	45	40	6
15,101 - 18,100	16	100	25	48	52	47	8
18,101 - 20,100	18	100	25	48	52	47	8

Ejemplo de tolerancia IT6:

FXR503Ø16.350H6MC1F-HP145

Diámetro del agujero $d_1 = 16,350 \text{ H6}$

Ejemplo de variante G:

FXR503GØ16.350-4MC1F-HP145

Diámetro especial de la herramienta $d_1 = 16.350 -4 \mu\text{m}$



Recomendación de valores de corte para FixReam FXR

Avance y velocidad de corte

FXR510 | FXR505

Material de corte: HP145 | Entrada: MF1M | MTOA

Grupo de arranque de virutas de Mapal*	Material	Rigidez/dureza [N/mm ²] [HRC]	Velocidad de corte v _c (m/min)			
			Refrigeración interna	Refrigeración exterior	MMS	
P	P4.1	Aceros inoxidables, ferríticos y martensíticos	40	20	30	
	P6.1	Fundición de acero inoxidable, ferrítica y martensítica	40	20	30	
M	M1.1	Aceros inoxidables, austeníticos	< 700	40	20	30
	M1.2	Aceros inoxidables, ferríticos/austeníticos (dúplex)	< 1000	30	15	20
	M2.1	Fundición de acero inoxidable, austenítica	< 700	40	20	30
	M3.1	Fundición de acero inoxidable, ferrítica/austenítica (dúplex)	< 1000	30	15	20

FXR510 | FXR505

Material de corte: HP145 | Entrada: MG1M | MV0A

Grupo de arranque de virutas de Mapal*	Material	Rigidez/dureza [N/mm ²] [HRC]	Velocidad de corte v _c (m/min)			
			Refrigeración interna	Refrigeración exterior	MMS	
P	P1.1	Aceros de construcción, para tornos automáticos, de cementación y revenidos, no aleados	< 700	180	90	150
	P1.2	Aceros de construcción, para tornos automáticos, de cementación y revenidos, no aleados	< 1200	140	70	115
	P2.1	Aceros nitrurados, de cementación y aceros revenidos, aleados	< 900	180	90	150
	P2.2	Aceros nitrurados, de cementación y aceros revenidos, aleados	< 1400	140	70	115
	P3.1	Aceros para herramientas, rodamientos, resortes y rápidos**	< 800	180	90	150
	P3.2	Aceros para herramientas, rodamientos, resortes y rápidos**	< 1000	140	70	110
	P3.3	Aceros para herramientas, rodamientos, resortes y rápidos**	< 1500	120	60	90
	P6.1	Fundición de acero		140	75	100
K	K1.1	Hierro fundido con grafito laminar (fundición gris), GJL	< 300	120	100	100
	K2.1	Hierro fundido con grafito esferoidal, GJS	< 500	150	105	130
	K2.2	Hierro fundido con grafito esferoidal, GJS	≤ 800	120	85	98
	K2.3	Hierro fundido con grafito esferoidal, GJS	> 800	90	55	70
	K3.1	Hierro fundido con grafito vermicular, GJV; fundición maleable, GJM	< 500	90	55	70
	K3.2	Hierro fundido con grafito vermicular, GJV; fundición maleable, GJM	> 500	90	55	70

* Grupos de mecanizado MAPAL

** Si los componentes de aleación de Cr, Mo, Ni, V, W suman > 8 %, elegir el siguiente grupo de mecanizado MAPAL superior.

	Avance f_z (mm/z) con diámetro de la herramienta						
	z 4	z 4	z 6	z 6	z 6	z 6	z 8
	< 5,000	> 5,000 - 6,200	> 6,200 - 8,000	> 8,000 - 12,000	> 12,000 - 16,000	> 16,000 - 16,200	> 16,200 - 20,200
	0,020	0,040	0,060	0,080	0,100	0,120	0,120
	0,020	0,040	0,060	0,080	0,100	0,120	0,120
	0,020	0,040	0,060	0,080	0,100	0,120	0,120
	0,020	0,040	0,060	0,080	0,100	0,120	0,120
	0,020	0,040	0,060	0,080	0,100	0,120	0,120
	0,020	0,040	0,060	0,080	0,100	0,120	0,120

	Avance f_z (mm/z) con diámetro de la herramienta						
	z 4	z 4	z 6	z 6	z 6	z 6	z 8
	< 5,000	> 5,000 - 6,200	> 6,200 - 8,000	> 8,000 - 12,000	> 12,000 - 16,000	> 16,000 - 16,200	> 16,200 - 20,200
	0,050	0,080	0,080	0,140	0,180	0,180	0,190
	0,050	0,080	0,080	0,140	0,180	0,180	0,190
	0,050	0,080	0,080	0,140	0,180	0,180	0,190
	0,050	0,080	0,080	0,140	0,180	0,180	0,190
	0,050	0,080	0,080	0,140	0,180	0,180	0,190
	0,050	0,080	0,080	0,140	0,180	0,180	0,190
	0,050	0,080	0,080	0,140	0,180	0,180	0,190
	0,050	0,080	0,080	0,140	0,180	0,180	0,190
	0,080	0,100	0,100	0,170	0,220	0,220	0,230
	0,080	0,100	0,100	0,170	0,220	0,220	0,230
	0,080	0,100	0,100	0,170	0,220	0,220	0,230
	0,080	0,100	0,100	0,170	0,220	0,220	0,230
	0,080	0,100	0,100	0,170	0,220	0,220	0,230
	0,080	0,100	0,100	0,170	0,220	0,220	0,230

Los valores de corte indicados son de referencia.

Los datos óptimos para cada situación de mecanizado deben determinarse mediante ensayos o durante el propio proceso de mecanizado.

Recomendación de valores de corte para FixReam FXR

Avance y velocidad de corte

FXR503-short

Material de corte: HP145 | Entrada: MC1F

Grupo de arranque de virutas de Mapal*	Material	Rigidez/dureza [N/mm ²] [HRC]	Velocidad de corte v _c (m/min)			
			Refrigeración interna	Refrigeración exterior	MMS	
P	P1.1	Aceros de construcción, para tornos automáticos, de cementación y revenidos, no aleados	< 700	180	90	150
	P1.2	Aceros de construcción, para tornos automáticos, de cementación y revenidos, no aleados	< 1200	140	70	115
	P2.1	Aceros nitrurados, de cementación y aceros revenidos, aleados	< 900	180	90	150
	P2.2	Aceros nitrurados, de cementación y aceros revenidos, aleados	< 1400	140	70	115
	P3.1	Aceros para herramientas, rodamientos, resortes y rápidos**	< 800	180	90	150
	P3.2	Aceros para herramientas, rodamientos, resortes y rápidos**	< 1000	140	70	110
	P3.3	Aceros para herramientas, rodamientos, resortes y rápidos**	< 1500	120	60	90
	P5.1	Fundición de acero		140	75	100
K	K1.1	Hierro fundido con grafito laminar (fundición gris), GJL	< 300	120	100	100
	K2.1	Hierro fundido con grafito esferoidal, GJS	< 500	150	105	130
	K2.2	Hierro fundido con grafito esferoidal, GJS	≤ 800	120	85	98
	K2.3	Hierro fundido con grafito esferoidal, GJS	> 800	90	55	70
	K3.1	Hierro fundido con grafito vermicular, GJV; fundición maleable, GJM	< 500	90	55	70
	K3.2	Hierro fundido con grafito vermicular, GJV; fundición maleable, GJM	> 500	90	55	70

FXR505 | FXR500

Material de corte: HP622 | Entrada: MVOA | MGOA

Grupo de arranque de virutas de Mapal*	Material	Rigidez/dureza [N/mm ²] [HRC]	Velocidad de corte v _c (m/min)			
			Refrigeración interna	Refrigeración exterior	MMS	
N	N1.1	Aluminio, aleado y no aleado < 3 % Si		250	125	190
	N1.2	Aluminio, aleado ≤ 7 % Si		250	125	190
	N1.3	Aluminio, aleado > 7-12 % Si		250	125	190
	N1.4	Aluminio, aleado > 12 % Si		250	125	190

FXR505 | FXR510

Material de corte: HU612 | Entrada: MVOA | MG1M

Grupo de arranque de virutas de Mapal*	Material	Rigidez/dureza [N/mm ²] [HRC]	Velocidad de corte v _c (m/min)			
			Refrigeración interna	Refrigeración exterior	MMS	
N2	N2.1	Cobre, no aleado y de baja aleación	< 300	50	25	
	N2.2	Cobre, aleado	> 300	50	25	
	N2.3	Latón, bronce, fundición roja	< 1200	50	25	40

* Grupos de mecanizado MAPAL

** Si los componentes de aleación de Cr, Mo, Ni, V, W suman > 8 %, elegir el siguiente grupo de mecanizado MAPAL superior.

	Avance f_z (mm/z) con diámetro de la herramienta						
	z 4	z 4	z 6	z 6	z 6	z 8	z 8
	< 5,000	> 5,000 - 6,100	> 6,100 - 8,000	> 8,000 - 12,000	> 12,000 - 15,100	> 15,100 - 16,000	> 16,000 - 20,100
	0,050	0,080	0,080	0,140	0,180	0,180	0,190
	0,050	0,080	0,080	0,140	0,180	0,180	0,190
	0,050	0,080	0,080	0,140	0,180	0,180	0,190
	0,050	0,080	0,080	0,140	0,180	0,180	0,190
	0,050	0,080	0,080	0,140	0,180	0,180	0,190
	0,050	0,080	0,080	0,140	0,180	0,180	0,190
	0,050	0,080	0,080	0,140	0,180	0,180	0,190
	0,050	0,080	0,080	0,140	0,180	0,180	0,190
	0,08	0,10	0,10	0,17	0,22	0,22	0,23
	0,08	0,10	0,10	0,17	0,22	0,22	0,23
	0,08	0,10	0,10	0,17	0,22	0,22	0,23
	0,08	0,10	0,10	0,17	0,22	0,22	0,23
	0,08	0,10	0,10	0,17	0,22	0,22	0,23
	0,08	0,10	0,10	0,17	0,22	0,22	0,23

	Avance f_z (mm/z) con diámetro de la herramienta						
	z 4	z 4	z 6	z 6	z 6	z 6	z 6
	< 5,000	> 5,000 - 6,200	> 6,200 - 8,000	> 8,000 - 12,000	> 12,000 - 16,000	> 16,000 - 16,200	> 16,200 - 20,200
	0,120	0,150	0,150	0,210	0,250	0,250	0,300
	0,120	0,150	0,150	0,210	0,250	0,250	0,300
	0,120	0,150	0,150	0,210	0,250	0,250	0,300
	0,120	0,150	0,150	0,210	0,250	0,250	0,300

	Avance f_z (mm/z) con diámetro de la herramienta						
	z 4	z 4	z 6	z 6	z 6	z 6	z 8
	< 5,000	> 5,000 - 6,200	> 6,200 - 8,000	> 8,000 - 12,000	> 12,000 - 16,000	> 16,000 - 16,200	> 16,200 - 20,200
	0,040	0,050	0,050	0,060	0,100	0,100	0,100
	0,040	0,050	0,050	0,060	0,100	0,100	0,100
	0,040	0,050	0,050	0,060	0,100	0,100	0,100

Los valores de corte indicados son de referencia.

Los datos óptimos para cada situación de mecanizado deben determinarse mediante ensayos o durante el propio proceso de mecanizado.

Recomendación de valores de corte para FixReam FXR

Avance y velocidad de corte

FXR510 | FXR505

Material de corte: HP625 | Entrada: MF1M | MTOA

Grupo de arranque de virutas de Mapal*	Material	Rigidez/dureza [N/mm ²] [HRC]	Velocidad de corte v _c (m/min)			
			Refrigeración interna	Refrigeración exterior	MMS	
S	S1 S1.1	Titanio, aleaciones de titanio	< 400	25	10	15
	S2 S2.1	Titanio, aleaciones de titanio	< 1200	25	10	15
	S2 S2.2	Titanio, aleaciones de titanio	> 1200	25	10	15
	S3 S3.1	Níquel, no aleado y aleado	< 900	25	10	15
	S3 S3.2	Níquel, no aleado y aleado	> 900	25	10	15
	S4 S4.1	Superalcación de gran resistencia al calor basada en Ni, Co y Fe		25	10	15
	S5 S5.1	Aleaciones de wolframio y molibdeno		25	10	15

FXR510 | FXR505

Material de corte: HC614 | Entrada: MF1M | MVOA

Grupo de arranque de virutas de Mapal*	Material	Rigidez/dureza [N/mm ²] [HRC]	Velocidad de corte v _c (m/min)			
			Refrigeración interna	Refrigeración exterior	MMS	
C	C1 C1.1	Matriz de plástico, reforzada con fibras de aramida (AFK)		50	25	30
	C1 C1.2	Matriz de plástico (termoestable), CFK/GFK		50	25	30
	C1 C1.3	Matriz de plástico (termoplástico), CFK/GFK		50	25	30

FXR500 | FXR505

Material de corte: HP141 | Entrada: MFOA | MTOA

Grupo de arranque de virutas de Mapal*	Material	Rigidez/dureza [N/mm ²] [HRC]	Velocidad de corte v _c (m/min)			
			Refrigeración interna	Refrigeración exterior	MMS	
H	H1 H1.1	Acero templado/fundición de acero	< 44	50	20	30
	H1 H1.2	Acero templado/fundición de acero	< 55	10	5	5

	Avance f_z (mm/z) con diámetro de la herramienta						
	z 4	z 4	z 6	z 6	z 6	z 6	z 8
	< 5,000	> 5,000 - 6,200	> 6,200 - 8,000	> 8,000 - 12,000	> 12,000 - 16,000	> 16,000 - 16,200	> 16,200 - 20,200
	0,020	0,040	0,060	0,080	0,100	0,100	0,100
	0,020	0,040	0,060	0,080	0,100	0,100	0,100
	0,020	0,040	0,060	0,080	0,100	0,100	0,100
	0,020	0,040	0,060	0,080	0,100	0,100	0,100
	0,020	0,040	0,060	0,080	0,100	0,100	0,100
	0,020	0,040	0,060	0,080	0,100	0,100	0,100
	0,020	0,040	0,060	0,080	0,100	0,100	0,100

	Avance f_z (mm/z) con diámetro de la herramienta						
	z 4	z 4	z 6	z 6	z 6	z 6	z 8
	< 5,000	> 5,000 - 6,200	> 6,200 - 8,000	> 8,000 - 12,000	> 12,000 - 16,000	> 16,000 - 16,200	> 16,200 - 20,200
	0,060	0,100	0,100	0,100	0,100	0,100	0,100
	0,060	0,100	0,100	0,100	0,100	0,100	0,100
	0,060	0,100	0,100	0,100	0,100	0,100	0,100

	Avance f_z (mm/z) con diámetro de la herramienta						
	z 4	z 4	z 6	z 6	z 6	z 6	z 6
	< 5,000	> 5,000 - 6,200	> 6,200 - 8,000	> 8,000 - 12,000	> 12,000 - 16,000	> 16,000 - 16,200	> 16,200 - 20,200
	0,015	0,025	0,020	0,040	0,050	0,050	0,050
	0,015	0,025	0,020	0,040	0,050	0,050	0,050

Los valores de corte indicados son de referencia.

Los datos óptimos para cada situación de mecanizado deben determinarse mediante ensayos o durante el propio proceso de mecanizado.

VISTA GENERAL DE LOS PRODUCTOS





















Serie MonoReam 700

Los escariadores de múltiples filos de la serie MonoReam 700 ofrecen un sistema de escariado novedoso, sencillo, eficiente y estandarizado. Los escariadores de la serie MonoReam están disponibles como versión expandible. En función del campo de aplicación y del material de corte, están disponibles como versión con ranuras oblicuas a la izquierda o con ranuras rectas para agujeros pasantes y agujeros ciegos, así como con diferentes entradas y materiales de corte.

MonoReam Plus

La serie MonoReam Plus está especialmente diseñada para el mecanizado de fundición y acero. Los escariadores de esta serie están equipados con una conducción del refrigerante innovadora y patentada. Un manguito asegura el abastecimiento óptimo de los insertos HPC con refrigerante.

El programa para agujeros pasantes y agujeros ciegos es óptimo para los mecanizados en el rango de diámetro de 3,850 a 8,200 mm.

MonoReam			
			
<p>MonoReam 700 Ejecución con ranuras rectas para el mecanizado de agujeros pasantes de metales no ferrosos con filos de metal duro sin recubrimiento (insertos de PCD a petición).</p> <p>Rango de Ø: 7,700 – 40,200 mm*</p> <p>   </p> <p></p>	<p>MonoReam 710 Ejecución con ranuras oblicuas a la izquierda para el mecanizado de agujeros pasantes con insertos de metal duro con o sin recubrimiento.</p> <p>Rango de Ø: 7,700 – 40,200 mm*</p> <p>   </p> <p> </p>	<p>MonoReam 705 Ejecución con ranuras rectas para el mecanizado de agujeros ciegos con insertos de metal duro con o sin recubrimiento (corte PCD a petición).</p> <p>Rango de Ø: 7,700 – 40,200 mm*</p> <p>   </p> <p>  </p>	
Página 358	Página 356	Página 359	

* El rango de diámetros puede variar según la serie.



Explicación del sistema serie 700

Los escariadores de la serie MonoReam 700 se utilizan como herramienta fija; sin embargo, esta serie está optimizada para el reafilado. A través del tornillo de expansión de una única pieza se expande el diámetro del escariador. El sistema de dilatación solamente es adecuado para la compensación previa al reafilado, pero no para ajustar o reajustar el diámetro. La expansión del diámetro permite reafilar todas las superficies funcionales, tanto en la entrada como en el diámetro de la herramienta.

MonoReam Plus



MonoReam Plus | MRP510
Cabezal de cermet macizo

Escariador de alto rendimiento con cabezal de cermet macizo, con ranuras oblicuas a la izquierda

Rango de Ø: 3,850 - 8,200 mm



MonoReam Plus | MRP505
Cabezal de cermet macizo

Escariador de alto rendimiento con cabezal de cermet macizo, con ranuras rectas

Rango de Ø: 3,850 - 8,200 mm



Visión general de la selección MonoReam | MonoReam Plus (1/2)

Clase de productos	Tipo de agujero	Idoneidad del material											
		P					K					N	
		1-2	3.1	3.2	3.3	4-6	1	2.1	2.2	2.3	K3	1-2	4
Performance		■	■	■			■	■	■	■			
		■	■	■	■	■	■	■	■	■	■		
												■	■
		■	■	■			■	■	■	■			
		■	■	■	■	■	■	■	■	■	■		
												■	■
		■	■	■			■	■					
		■	■	■			■	■					

Ejemplo de pedido:

Serie MonoReam Plus

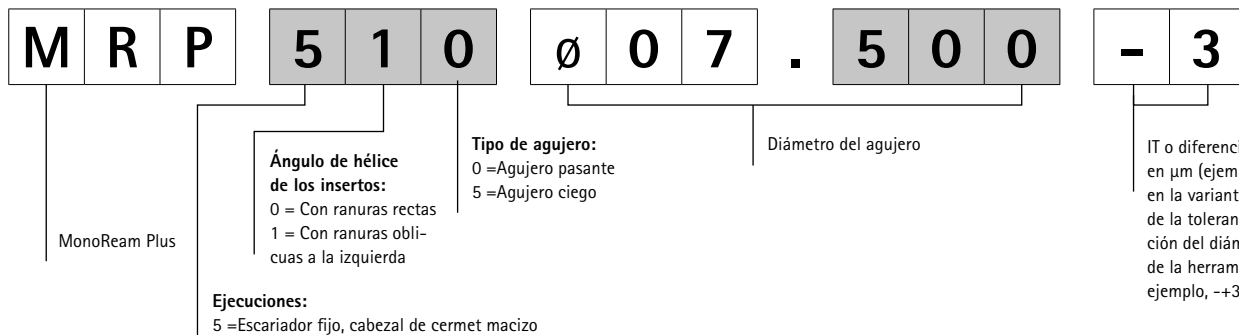





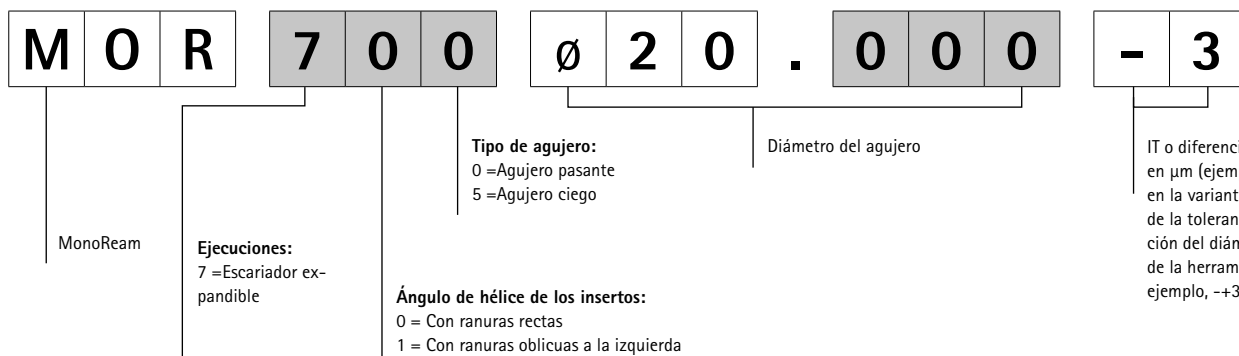

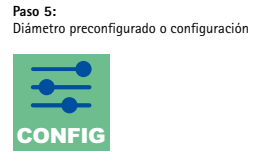
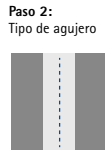







Ejemplo de pedido:

Serie MonoReam



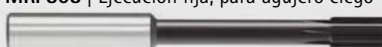

	Ejecución					Diámetro preconfigurado		Configuración
	d ₁	Material de corte	Entrada	 fijo	 expandible	Serie	Página	
	7,700 - 40,200	CU130	MY1G			MOR710	356	MOR710 Ejecución expandible, para agujero pasante 
	7,700 - 40,200	HP421	MY1G			MOR710	357	
	7,700 - 40,200	HU612	MY1G			MOR700	358	MOR700 
	7,700 - 40,200	CU130	MU2A			MOR705	359	MOR705 Ejecución expandible, para agujero ciego 
	7,700 - 40,200	HP421	MU2A			MOR705	360	
	7,700 - 40,200	HU612	MU2A			MOR705	361	
	3,850 - 8,200	CU178	MG1M			MRP510	362	MRP510 Ejecución fija, para agujero pasante 
	3,850 - 8,200	CU178	MV3C			MRP505	363	MRP505 Ejecución fija, para agujero ciego 

Entrada [Lead]

Material de corte [Cut]

M G 1 M

—

C U 1 7 8

Forma de entrada y ángulo de desprendimiento:
MG1M
MV3C

Para la explicación de las geometrías de entrada, véase la página 752.

Material de corte:
CU178

Entrada [Lead]

Material de corte [Cut]

M Y 1 G

—

C P 1 3 6

Forma de entrada y ángulo de desprendimiento:
MY1G
MU2A

Para la explicación de las geometrías de entrada, véase la página 752.

Material de corte:
HP421
HU612
CU130
PCD

Visión general de la selección MonoReam | Configuración MonoReam Plus (2/2)

MOR710

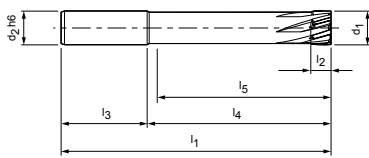

MOR700

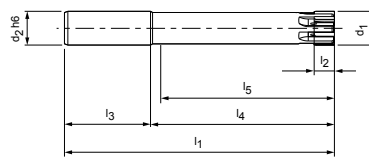

MOR705

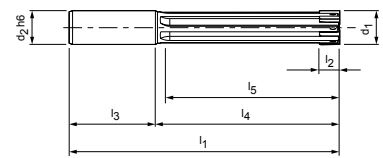

Dimensiones de la herramienta

MOR710 | MOR700

d ₁	d ₂	l ₁	l ₂	l ₃	l ₄	l ₅	z
7,700 - 9,700	12	120	8	45	75	70	4
9,701 - 11,700	12	120	8	45	75	70	6
11,701 - 17,200	16	140	8	48	92	87	6
17,201 - 22,200	20	160	12	50	110	105	6
22,201 - 27,200	20	180	12	50	130	125	6
27,201 - 29,200	25	200	12	56	144	139	6
29,201 - 40,200	25	200	12	56	144	139	8

MOR705

d ₁	d ₂	l ₁	l ₂	l ₃	l ₄	l ₅	z
7,700 - 9,700	12	120	8	45	75	64	4
9,701 - 11,700	12	120	8	45	75	65	6
11,701 - 17,200	16	140	8	48	92	80	6
17,201 - 18,200	20	160	12	50	110	98	6
18,201 - 19,200	20	160	12	50	110	99	6
19,201 - 22,200	20	160	12	50	110	100	6
22,201 - 27,200	20	180	12	50	130	120	6
27,201 - 29,200	25	200	12	56	144	130	6
29,201 - 40,200	25	200	12	56	144	130	8



MRP510

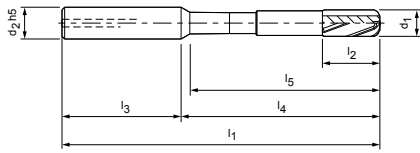

MRP505

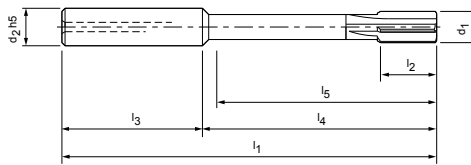
**Dimensiones de la herramienta**

MRP510

d ₁	d ₂	l ₁	l ₂	l ₃	l ₄	l ₅	z
3,850 - 4,900	10	80	14	40	40	33	4
4,901 - 6,200	12	85	14	45	40	33	4
6,201 - 6,700	12	105	14	45	60	52	6
6,701 - 8,200	12	110	18	45	65	57	6

MRP505

d ₁	d ₂	l ₁	l ₂	l ₃	l ₄	l ₅	z
3,850 - 4,900	10	80	12	40	40	33	4
4,901 - 6,200	12	85	12	45	40	33	4
6,201 - 6,700	12	105	12	45	60	53	6
6,701 - 8,200	12	110	16	45	65	58	6

Tolerancias para la variante G/variante fija MOR7XX | MRP5XX:

Material de corte	Rango de diámetros
	Ø 7,700 - 40,200
Sin recubrimiento	-0,003
CU130	
HU612	
CU178	
Recubrimiento (grosor de la capa 1 - 2 µm)	-0,004
HP421	
CP136	

Explicación de la variante G MOR | MRP

Tolerancias permitidas de la pieza para la selección del diámetro de la herramienta

Ejecución variante G

La variante G indica el diámetro de la herramienta del escariador con nuestras tolerancias de fabricación. Las tolerancias de fabricación dependen del material de corte. Véanse las tolerancias mínimas permitidas para la variante G.

MonoReam

Ejecución expandible, para agujero pasante
MOR710

Ejecución:

Diámetro del escariador: 7,700 - 40,200 mm
 MY1G
 Entrada: CU130
 Material de corte: Cermet sin recubrimiento

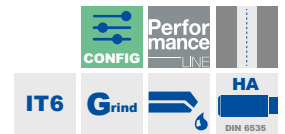
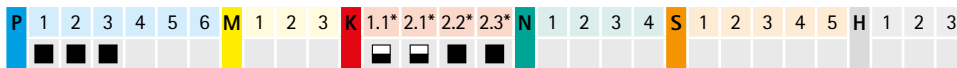
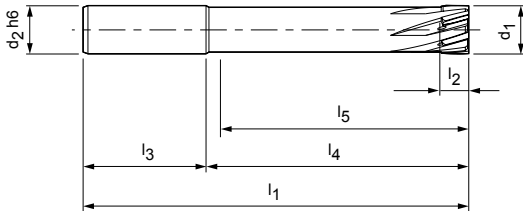

Características configurables



Tolerancia del diámetro del agujero ≥ IT6
 - Diámetro seleccionable libremente en incrementos de 0,001 mm
 - Se puede pedir en tolerancia ≥ IT6

Especificación
 MOR710Ø[diámetro][tolerancia]MY1G-CU130

Variante G
 - Diámetro seleccionable libremente en incrementos de 0,001 mm
 - Se puede pedir a partir de la tolerancia ≥ 3 µm (para la variante G, véase la página 355)

Especificación de la variante G:
 MOR710GØ[diámetro][tolerancia]MY1G-CU130

Dimensiones de la serie configurable IT6

d ₁	d ₂	l ₁	l ₂	l ₃	l ₄	l ₅	z
7,700 - 9,700	12	120	8	45	75	70	4
9,701 - 11,700	12	120	8	45	75	70	6
11,701 - 17,200	16	140	8	48	92	87	6
17,201 - 22,200	20	160	12	50	110	105	6
22,201 - 27,200	20	180	12	50	130	125	6
27,201 - 29,200	25	200	12	56	144	139	6
29,201 - 40,200	25	200	12	56	144	139	8

Ejemplo de tolerancia IT6:
 MOR710Ø16.350H6MY1G-CU130

Diámetro del agujero d₁ = 16,350 H6

Ejemplo de variante G:
 MOR710GØ16.350-3MY1G-CU130

Diámetro especial de la herramienta d₁ = 16,350 -3 µm

Medidas en mm.
 * para superficies R_a < 2 µm
 Para la recomendación de valores de corte, véase al final del capítulo.

MonoReam

Ejecución expandible, para agujero pasante
MOR710

Ejecución:

Diámetro del escariador: 7,700 - 40,200 mm
Entrada: MY1G
Material de corte: HP421
Metal duro con recubrimiento de PVD

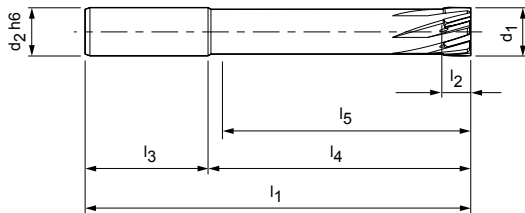

Características configurables



Tolerancia del diámetro del agujero \geq IT6

- Diámetro seleccionable libremente en incrementos de 0,001 mm
- Se puede pedir en tolerancia \geq IT6

Especificación

MOR710Ø[diámetro][tolerancia]MY1G-HP421

Variante G

- Diámetro seleccionable libremente en incrementos de 0,001 mm
- Se puede pedir a partir de la tolerancia $\geq 4 \mu\text{m}$ (para la variante G, véase la página 355)

Especificación de la variante G:

MOR710GØ[diámetro][tolerancia]MY1G-HP421

Dimensiones de la serie configurable IT6

d_1	d_2	l_1	l_2	l_3	l_4	l_5	z
7,700 - 9,700	12	120	8	45	75	70	4
9,701 - 11,700	12	120	8	45	75	70	6
11,701 - 17,200	16	140	8	48	92	87	6
17,201 - 22,200	20	160	12	50	110	105	6
22,201 - 27,200	20	180	12	50	130	125	6
27,201 - 29,200	25	200	12	56	144	139	6
29,201 - 40,200	25	200	12	56	144	139	8

Ejemplo de tolerancia IT6:

MOR710Ø16.350H6MY1G-HP421

Diámetro del agujero $d_1 = 16,350 \text{ H6}$

Ejemplo de variante G:

MOR710GØ16.350-4MY1G-HP421

Diámetro especial de la herramienta $d_1 = 16,350 -4 \mu\text{m}$

Medidas en mm.

Para la recomendación de valores de corte, véase al final del capítulo.

MonoReam

Ejecución expandible, para agujero pasante
MOR700

Ejecución:

Diámetro del escariador: 7,700 - 40,200 mm
MY1G
Entrada: HU612
Material de corte: Metal duro sin recubrimiento

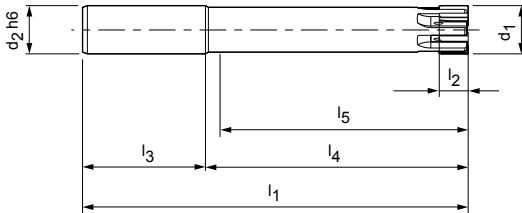

Características configurables



Tolerancia del diámetro del agujero \geq IT6
- Diámetro seleccionable libremente en incrementos de 0,001 mm
- Se puede pedir en tolerancia \geq IT6

Especificación
MOR700Ø[diámetro][tolerancia]MY1G-HU612

Variante G
- Diámetro seleccionable libremente en incrementos de 0,001 mm
- Se puede pedir a partir de la tolerancia \geq 3 μ m (para la variante G, véase la página 355)

Especificación de la variante G:
MOR700GØ[diámetro][tolerancia]MY1G-HU612

Dimensiones de la serie configurable IT6

d_1	d_2	l_1	l_2	l_3	l_4	l_5	z
7,700 - 9,700	12	120	8	45	75	70	4
9,701 - 11,700	12	120	8	45	75	70	6
11,701 - 17,200	16	140	8	48	92	87	6
17,201 - 22,200	20	160	12	50	110	105	6
22,201 - 27,200	20	180	12	50	130	125	6
27,201 - 29,200	25	200	12	56	144	139	6
29,201 - 40,200	25	200	12	56	144	139	8

Ejemplo de tolerancia IT6:
MOR700Ø16.350H6MY1G-HU612

Diámetro del agujero $d_1 = 16,350$ H6

Ejemplo de variante G:
MOR700GØ16.350-3MY1G-HU612

Diámetro especial de la herramienta $d_1 = 16,350 -3 \mu$ m

MonoReam

Ejecución expansible, con ranuras rectas, para agujeros ciegos MOR705

Ejecución:

Diámetro del escariador: 7,700 - 40,200 mm
 Entrada: MU2A
 Material de corte: Cermet sin recubrimiento

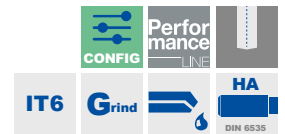
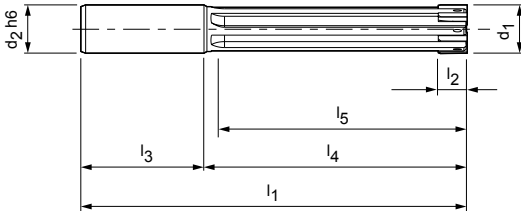

Características configurables



Tolerancia del diámetro del agujero \geq IT6

- Diámetro seleccionable libremente en incrementos de 0,001 mm
- Se puede pedir en tolerancia \geq IT6

Especificación

MOR705Ø[diámetro][tolerancia]MU2A-CU130

Variante G

- Diámetro seleccionable libremente en incrementos de 0,001 mm
- Se puede pedir a partir de la tolerancia $\geq 3 \mu\text{m}$ (para la variante G, véase la página 355)

Especificación de la variante G:

MOR705GØ[diámetro][tolerancia]MU2A-CU130

Dimensiones de la serie configurable IT6

d_1	d_2	l_1	l_2	l_3	l_4	l_5	z
7,700 - 9,700	12	120	8	45	75	64	4
9,701 - 11,700	12	120	8	45	75	65	6
11,701 - 17,200	16	140	8	48	92	80	6
17,201 - 18,200	20	160	12	50	110	98	6
18,201 - 19,200	20	160	12	50	110	99	6
19,201 - 22,200	20	160	12	50	110	100	6
22,201 - 27,200	20	180	12	50	130	120	6
27,201 - 29,200	25	200	12	56	144	130	6
29,201 - 40,200	25	200	12	56	144	130	8

Ejemplo de tolerancia IT6:

MOR705Ø16.350H6MU2A-CU130

Diámetro del agujero $d_1 = 16,350 \text{ H6}$

Ejemplo de variante G:

MOR705GØ16.350-3MU2A-CU130

Diámetro especial de la herramienta $d_1 = 16,350 -3 \mu\text{m}$

Medidas en mm.

* para superficies $R_a < 2 \mu\text{m}$

Para la recomendación de valores de corte, véase al final del capítulo.

MonoReam

Ejecución expansible, con ranuras rectas, para agujeros ciegos MOR705

Ejecución:

Diámetro del escariador: 7,700 - 40,200 mm

Entrada: MU2A

Material de corte: HP421

Metal duro con recubrimiento de PVD

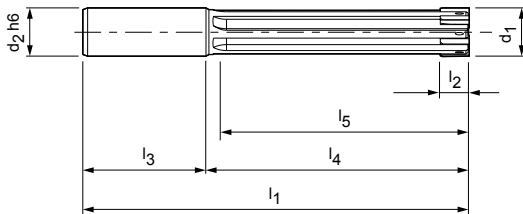

Características configurables



Tolerancia del diámetro del agujero \geq IT6

- Diámetro seleccionable libremente en incrementos de 0,001 mm
- Se puede pedir en tolerancia \geq IT6

Especificación

MOR705Ø[diámetro][tolerancia]MU2A-HP421

Variante G

- Diámetro seleccionable libremente en incrementos de 0,001 mm
- Se puede pedir a partir de la tolerancia \geq 4 μ m (para la variante G, véase la página 355)

Especificación de la variante G:

MOR705GØ[diámetro][tolerancia]MU2A-HP421

Dimensiones de la serie configurable IT6

d_1	d_2	l_1	l_2	l_3	l_4	l_5	z
7,700 - 9,700	12	120	8	45	75	64	4
9,701 - 11,700	12	120	8	45	75	65	6
11,701 - 17,200	16	140	8	48	92	80	6
17,201 - 18,200	20	160	12	50	110	98	6
18,201 - 19,200	20	160	12	50	110	99	6
19,201 - 22,200	20	160	12	50	110	100	6
22,201 - 27,200	20	180	12	50	130	120	6
27,201 - 29,200	25	200	12	56	144	130	6
29,201 - 40,200	25	200	12	56	144	130	8

Ejemplo de tolerancia IT6:

MOR705Ø16.350H6MU2A-HP421

Diámetro del agujero $d_1 = 16,350$ H6

Ejemplo de variante G:

MOR705GØ16.350-4MU2A-HP421

Diámetro especial de la herramienta $d_1 = 16.350 -4 \mu$ m

MonoReam

Ejecución expansible, con ranuras rectas, para agujeros ciegos
MOR705

Ejecución:

Diámetro del escariador: 7,700 - 40,200 mm

Entrada: MU2A

Material de corte: HU612
Metal duro sin recubrimiento

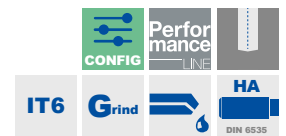
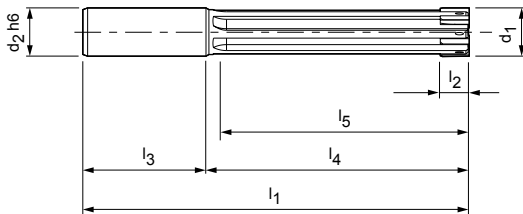

Características configurables



Tolerancia del diámetro del agujero \geq IT6

- Diámetro seleccionable libremente en incrementos de 0,001 mm
- Se puede pedir en tolerancia \geq IT6

Especificación

MOR705Ø[diámetro][tolerancia]MU2A-HU612

Variante G

- Diámetro seleccionable libremente en incrementos de 0,001 mm
- Se puede pedir a partir de la tolerancia \geq 3 μ m (para la variante G, véase la página 355)

Especificación de la variante G:

MOR705GØ[diámetro][tolerancia]MU2A-HU612

Dimensiones de la serie configurable IT6

d_1	d_2	l_1	l_2	l_3	l_4	l_5	z
7,700 - 9,700	12	120	8	45	75	64	4
9,701 - 11,700	12	120	8	45	75	65	6
11,701 - 17,200	16	140	8	48	92	80	6
17,201 - 18,200	20	160	12	50	110	98	6
18,201 - 19,200	20	160	12	50	110	99	6
19,201 - 22,200	20	160	12	50	110	100	6
22,201 - 27,200	20	180	12	50	130	120	6
27,201 - 29,200	25	200	12	56	144	130	6
29,201 - 40,200	25	200	12	56	144	130	8

Ejemplo de tolerancia IT6:

MOR705Ø16.350H6MU2A-HU612

Diámetro del agujero $d_1 = 16,350$ H6

Ejemplo de variante G:

MOR705GØ16.350-3MU2A-HU612

Diámetro especial de la herramienta $d_1 = 16,350$ -3 μ m

Medidas en mm.

Para la recomendación de valores de corte, véase al final del capítulo.

MonoReam Plus

Ejecución fija, para agujero pasante
MRP510

Ejecución:

Diámetro del escariador: 3,850 - 8,200 mm
Entrada: MG1M
Material de corte: CU178
Cermet sin recubrimiento

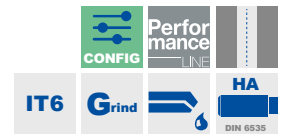
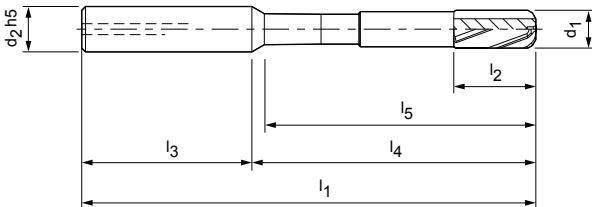

Características configurables



Tolerancia del diámetro del agujero \geq IT6
- Diámetro seleccionable libremente en incrementos de 0,001 mm
- Se puede pedir en tolerancia \geq IT6

Especificación
MRP510Ø[diámetro][tolerancia]MG1M-CU178

Variante G
- Diámetro seleccionable libremente en incrementos de 0,001 mm
- Se puede pedir a partir de la tolerancia \geq 3 μ m (para la variante G, véase la página 355)

Especificación de la variante G:
MRP510GØ[diámetro][tolerancia]MG1M-CU178

Dimensiones de la serie configurable IT6

d ₁	d ₂	l ₁	l ₂	l ₃	l ₄	l ₅	z
3,850 - 4,900	10	80	14	40	40	33	4
4,901 - 6,200	12	85	14	45	40	33	4
6,201 - 6,700	12	105	14	45	60	52	6
6,701 - 8,200	12	110	18	45	65	57	6

Ejemplo de tolerancia IT6:
MRP510Ø5.350H6MG1M-CU178

Diámetro del agujero d₁ = 5,350 mm H6

Ejemplo de variante G:
MRP510GØ5.350-3MG1M-CU178

Diámetro especial de la herramienta d₁ = 5,350 -3 μ m

Medidas en mm.
* para superficies R_a < 2 μ m
Para la recomendación de valores de corte, véase al final del capítulo.

MonoReam Plus

Ejecución fija, para agujero pasante
MRP505

Ejecución:

Diámetro del escariador: 3,850 - 8,200 mm
Entrada: MV3C
Material de corte: CU178
Cermet sin recubrimiento

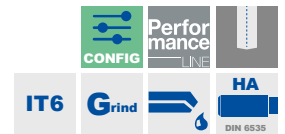
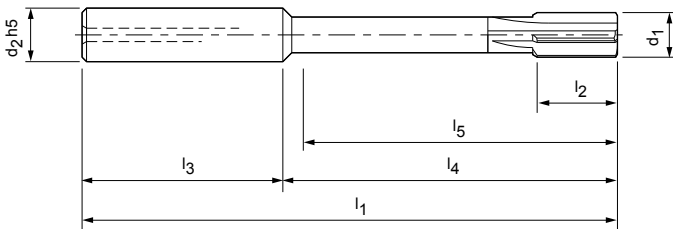

Características configurables



Tolerancia del diámetro del agujero \geq IT6

- Diámetro seleccionable libremente en incrementos de 0,001 mm
- Se puede pedir en tolerancia \geq IT6

Especificación

MRP505Ø[diámetro][tolerancia]MV3C-CU178

Variante G

- Diámetro seleccionable libremente en incrementos de 0,001 mm
- Se puede pedir a partir de la tolerancia $\geq 3 \mu\text{m}$ (para la variante G, véase la página 355)

Especificación de la variante G:

MRP505GØ[diámetro][tolerancia]MV3C-CU178

Dimensiones de la serie configurable IT6

d_1	d_2	l_1	l_2	l_3	l_4	l_5	z
3,850 - 4,900	10	80	12	40	40	33	4
4,901 - 6,200	12	85	12	45	40	33	4
6,201 - 6,700	12	105	12	45	60	53	6
6,701 - 8,200	12	110	16	45	65	58	6

Ejemplo de tolerancia IT6:

MRP505Ø5.350H6MV3C-CU178

Diámetro del agujero $d_1 = 5,350 \text{ mm H6}$

Ejemplo de variante G:

MRP505Ø5.350-3MV3C-CU178

Diámetro especial de la herramienta $d_1 = 5,350 -3 \mu\text{m}$

Medidas en mm.

* para superficies $R_a < 2 \mu\text{m}$

Para la recomendación de valores de corte, véase al final del capítulo.

Recomendación de valores de corte para MonoReam MOR | MonoReam Plus MRP

Avance y velocidad de corte

MRP505 | MRP510

Material de corte: CU178 | Entrada: MV3C | MG1M

Grupo de arranque de virutas de Mapal*	Material	Rigidez/dureza [N/mm ²] [HRC]	Velocidad de corte v _c (m/min)			
			Refrigeración interna	Refrigeración exterior	MMS	
P	P1.1	Aceros de construcción, para tornos automáticos, de cementación y revenidos, no aleados	< 700	150	75	125
	P1.2	Aceros de construcción, para tornos automáticos, de cementación y revenidos, no aleados	< 1200	150	75	125
	P2.1	Aceros nitrurados, de cementación y aceros revenidos, aleados	< 900	130	65	110
	P2.2	Aceros nitrurados, de cementación y aceros revenidos, aleados	< 1400	130	65	110
	P3.1	Aceros para herramientas, rodamientos, resortes y rápidos**	< 800	130	65	110
	P3.2	Aceros para herramientas, rodamientos, resortes y rápidos**	< 1000	120	60	100
	P3.3	Aceros para herramientas, rodamientos, resortes y rápidos**	< 1500			

MOR705 | MOR710

Material de corte: CU130 | Entrada: MU2A | MY1G

Grupo de arranque de virutas de Mapal*	Material	Rigidez/dureza [N/mm ²] [HRC]	Velocidad de corte v _c (m/min)			
			Refrigeración interna	Refrigeración exterior	MMS	
P	P1.1	Aceros de construcción, para tornos automáticos, de cementación y revenidos, no aleados	< 700	150	75	125
	P1.2	Aceros de construcción, para tornos automáticos, de cementación y revenidos, no aleados	< 1200	150	75	125
	P2.1	Aceros nitrurados, de cementación y aceros revenidos, aleados	< 900	130	65	110
	P2.2	Aceros nitrurados, de cementación y aceros revenidos, aleados	< 1400	130	65	110
	P3.1	Aceros para herramientas, rodamientos, resortes y rápidos**	< 800	130	65	110
	P3.2	Aceros para herramientas, rodamientos, resortes y rápidos**	< 1000	120	60	100
	P3.3	Aceros para herramientas, rodamientos, resortes y rápidos**	< 1500			
K	K1.1	Hierro fundido con grafito laminar (fundición gris), GJL	< 300	120	100	100
	K2.1	Hierro fundido con grafito esferoidal, GJS	< 500	120	85	105
	K2.2	Hierro fundido con grafito esferoidal, GJS	≤ 800			
	K2.3	Hierro fundido con grafito esferoidal, GJS	> 800			

MOR705 | MOR710

Material de corte: HP421 | Entrada: MU2A | MY1G

Grupo de arranque de virutas de Mapal*	Material	Rigidez/dureza [N/mm ²] [HRC]	Velocidad de corte v _c (m/min)			
			Refrigeración interna	Refrigeración exterior	MMS	
P	P3.1	Aceros para herramientas, rodamientos, resortes y rápidos**	< 800			
	P3.2	Aceros para herramientas, rodamientos, resortes y rápidos**	< 1000			
	P3.3	Aceros para herramientas, rodamientos, resortes y rápidos**	< 1500	100	50	75
	P4.1	Aceros inoxidables, ferríticos y martensíticos		40	20	30
	P5.1	Fundición de acero		110	60	80
	P6.1	Fundición de acero inoxidable, ferrítica y martensítica		40	20	30
K	K1.1	Hierro fundido con grafito laminar (fundición gris), GJL	< 300	120	100	100
	K2.1	Hierro fundido con grafito esferoidal, GJS	< 500	110	80	95
	K2.2	Hierro fundido con grafito esferoidal, GJS	≤ 800	90	65	75
	K2.3	Hierro fundido con grafito esferoidal, GJS	> 800	90	55	70
	K3.1	Hierro fundido con grafito vermicular, GJV; fundición maleable, GJM	< 500	90	55	70
	K3.2	Hierro fundido con grafito vermicular, GJV; fundición maleable, GJM	> 500	90	55	70

* Grupos de mecanizado MAPAL

** Si los componentes de aleación de Cr, Mo, Ni, V, W suman > 8 %, elegir el siguiente grupo de mecanizado MAPAL superior.

Avance f_z (mm/z) con diámetro de la herramienta			
	z 4	z 4	z 6
	< 5,000	5,000 - 6,200	> 6,200 - 8,200
	0,025	0,040	0,060
	0,025	0,040	0,060
	0,025	0,040	0,060
	0,025	0,040	0,060
	0,025	0,040	0,060
	0,025	0,040	0,060

Avance f_z (mm/z) con diámetro de la herramient				
	z 4	z 6	z 6	z 8
	8,000 - 9,700	> 9,700 - 16,000	> 16,000 - 29,200	> 29,200 - 40,200
	0,100	0,150	0,150	0,150
	0,100	0,150	0,150	0,150
	0,100	0,150	0,150	0,150
	0,080	0,120	0,120	0,120
	0,100	0,150	0,150	0,150
	0,100	0,150	0,150	0,150
	0,150	0,200	0,200	0,250
	0,150	0,180	0,180	0,180

Avance f_z (mm/z) con diámetro de la herramient				
	z 4	z 6	z 6	z 8
	8,000 - 9,700	> 9,700 - 16,000	> 16,000 - 29,200	> 29,200 - 40,200
	0,100	0,150	0,150	0,150
	0,080	0,100	0,120	0,120
	0,150	0,150	0,150	0,150
	0,080	0,100	0,120	0,120
	0,150	0,200	0,200	0,250
	0,150	0,180	0,180	0,180
	0,150	0,180	0,180	0,180
	0,120	0,150	0,150	0,150
	0,150	0,180	0,180	0,180
	0,150	0,150	0,150	0,150

Los valores de corte indicados son de referencia.

Los datos óptimos para cada situación de mecanizado deben determinarse mediante ensayos o durante el propio proceso de mecanizado.

Recomendación de valores de corte para MonoReam MOR

Avance y velocidad de corte

MOR700

Material de corte: HU612 | Entrada: MY1G

Grupo de arranque de virutas de Mapal*	Material	Rigidez/dureza [N/mm ²] [HRC]	Velocidad de corte v _c (m/min)		
			Refrigeración interna	Refrigeración exterior	MMS
N1	N1.1 Aluminio, aleado y no aleado < 3 % Si		50	25	40
	N1.2 Aluminio, aleado ≤ 7 % Si		50	25	40
	N1.3 Aluminio, aleado > 7-12 % Si		30	15	25
	N1.4 Aluminio, aleado > 12 % Si		30	15	25
N2	N2.1 Cobre, no aleado y de baja aleación	< 300	50	25	
	N2.2 Cobre, aleado	> 300	50	25	
	N2.3 Latón, bronce, fundición roja	< 1200	50	25	40
N4	N4.1 Plástico, termoplásticos		40	20	
	N4.2 Plástico, plásticos termoestables		40	20	
	N4.3 Plástico, espumas		40	20	

MOR705

Material de corte: HU612 | Entrada: MU2A

Grupo de arranque de virutas de Mapal*	Material	Rigidez/dureza [N/mm ²] [HRC]	Velocidad de corte v _c (m/min)		
			Refrigeración interna	Refrigeración exterior	MMS
N1	N1.1 Aluminio, aleado y no aleado < 3 % Si		50	25	40
	N1.2 Aluminio, aleado ≤ 7 % Si		50	25	40
	N1.3 Aluminio, aleado > 7-12 % Si		30	15	25
	N1.4 Aluminio, aleado > 12 % Si		30	15	25
N2	N2.1 Cobre, no aleado y de baja aleación	< 300	50	25	
	N2.2 Cobre, aleado	> 300	50	25	
	N2.3 Latón, bronce, fundición roja	< 1200	50	25	40

* Grupos de mecanizado MAPAL

	Avance f_z (mm/z) con diámetro de la herramient			
	z 4	z 6	z 6	z 8
	8,000 - 9,700	> 9,700 - 16,000	> 16,000 - 29,200	> 29,200 - 40,200
	0,050	0,080	0,100	0,120
	0,050	0,080	0,100	0,120
	0,050	0,080	0,100	0,120
	0,050	0,080	0,100	0,120
	0,050	0,080	0,100	0,120
	0,050	0,080	0,100	0,120
	0,050	0,080	0,100	0,120
	0,050	0,080	0,080	0,080
	0,050	0,080	0,080	0,080
	0,050	0,080	0,080	0,080

	Avance f_z (mm/z) con diámetro de la herramient			
	z 4	z 6	z 6	z 8
	8,000 - 9,700	> 9,700 - 16,000	> 16,000 - 29,200	> 29,200 - 40,200
	0,050	0,080	0,100	0,120
	0,050	0,080	0,100	0,120
	0,050	0,080	0,100	0,120
	0,050	0,080	0,100	0,120
	0,050	0,080	0,100	0,120
	0,050	0,080	0,100	0,120
	0,050	0,080	0,100	0,120

Los valores de corte indicados son de referencia.

Los datos óptimos para cada situación de mecanizado deben determinarse mediante ensayos o durante el propio proceso de mecanizado.

VISTA GENERAL DE LOS PRODUCTOS

Escariador de cabezal intercambiable HPR

El programa HPR de escariadores de cabezal intercambiable comprende series para agujeros pasantes y agujeros ciegos a partir de un diámetro de 7,00 mm. Los escariadores de cabezal intercambiable están disponibles como ejecución fija (serie XX) o bien como ejecución de ajuste de precisión (serie XX), y pueden equiparse con diferentes materiales de corte como metal duro o cermet. Los escariadores pueden configurarse en el rango de diámetro de entre 7,00 y 65,00 mm en pasos de μm ; el rango de tolerancia $\geq \text{IT5}$ también puede configurarse. Como serie preferente está disponible un amplio programa de dimensiones H7.

Los portaherramientas correspondientes con Head Fitting System (HFS) se caracterizan por una precisión exacta de concentricidad y de cambio inferior a los $3 \mu\text{m}$, así como por un manejo seguro y sencillo, especialmente durante el montaje y desmontaje del cabezal de la herramienta. HFS garantiza una gran precisión y transmisión de potencia. Gracias a la sencilla construcción con conducción directa del refrigerante hasta el inserto, el sistema es condicionalmente adecuado para la lubricación de cantidad mínima (MQL).

HPR – Ejecución fija



Serie HPR 100 | 130 | 131 | 110 | 150 | 180

Ejecución fija con insertos soldados.

Rango de \varnothing : 7,000 – 65,000 mm*

Perfor
mance
LINE

CONFIG IT G_{grind}

P M K N S



HPR – Ejecución de ajuste de precisión



Serie HPR 200 | 230 | 231 | 210 | 250 | 280

Posibilidad de ajuste de precisión micrométrica mediante sistema de ajuste.

Rango de \varnothing : 7,000 – 65,000 mm*

Expert
LINE

CONFIG IT Grind

P M K N S

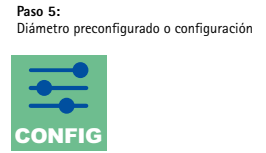

	Ejecución			Diámetro preconfigurado				Configuración
	d1	Material de corte	Entrada	Perforance LINE	Serie fija	Expert LINE	Serie con ajuste fino	
				Serie	Página	Serie	Página	
	7,000 - 18,590	CU134	ME1G	HPR131	379	HPR231	418	HPR131 HPR231
	15,600 - 65,000	CU134	ME1G	HPR110	390	HPR210	426	
	7,000 - 18,590	HP421	ME1G	HPR131	380	HPR231	419	
	15,600 - 65,000	HP421	ME1G	HPR110	392	HPR210	427	
	7,000 - 18,590	HP421	MF1G	HPR131	381	HPR231	420	
	15,600 - 65,000	HP421	MF1G	HPR110	394	HPR210	428	
	7,000 - 18,590	CP134	MC1G	HPR130	374	HPR230	414	
	15,600 - 65,000	CP134	MC1G	HPR100	383	HPR200	422	
	7,000 - 18,590	HC419	MC1G	HPR130	375			
	15,600 - 65,000	HC419	MC1G	HPR100	384			
	7,000 - 18,590	HP421	MC1G	HPR130	376	HPR230	415	
	15,600 - 65,000	HP421	MC1G	HPR100	386	HPR200	423	
	7,000 - 18,590	HP423	MC1G	HPR130	377	HPR230	416	
	15,600 - 65,000	HP423	MC1G	HPR100	388	HPR200	424	
	7,000 - 18,590	PU620	MA0A	HPR130	378	HPR230	417	
	15,600 - 65,000	PU620	MA0A	HPR100	389	HPR200	425	
	7,000 - 18,590	HP625	MF1G	HPR131	382	HPR231	421	
	15,600 - 65,000	HP625	MF1G	HPR110	393	HPR210	431	
	7,000 - 21,290	CU134	ML2G	HPR180	396	HPR280	430	
	16,600 - 65,000	CU134	ML2G	HPR150	405	HPR250	438	
	7,000 - 21,290	HP421	ML2G	HPR180	397	HPR280	431	
	16,600 - 65,000	HP421	ML2G	HPR150	406	HPR250	439	
	7,000 - 21,290	HP421	MO2G	HPR180	398	HPR280	432	
	16,600 - 65,000	HP421	MO2G	HPR150	407	HPR250	440	
	7,000 - 21,290	CP134	MC1G	HPR180	399	HPR280	433	
	16,600 - 65,000	CP134	MC1G	HPR150	408	HPR250	441	
	7,000 - 21,290	HC419	MC1G	HPR180	400			
	16,600 - 65,000	HC419	MC1G	HPR150	403			
	7,000 - 21,290	HP421	MC1G	HPR180	401	HPR280	434	
	16,600 - 65,000	HP421	MC1G	HPR150	410	HPR250	442	
	7,000 - 21,290	HP423	MC1G	HPR180	402	HPR280	435	
	16,600 - 65,000	HP423	MC1G	HPR150	411	HPR250	443	
	7,000 - 21,290	PU620	MA0A	HPR180	403	HPR280	436	
	16,600 - 65,000	PU620	MA0A	HPR150	412	HPR250	444	
	7,000 - 21,290	HP625	MO2G	HPR180	404	HPR280	437	
	16,600 - 65,000	HP625	MO2G	HPR150	413	HPR250	445	

La configuración de la serie continúa en la página siguiente.

Visión general de la selección HPR | Configuración (2/2)

HPR131 | HPR231

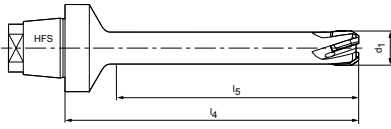

HPR130 | HPR230

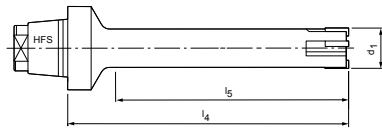

HPR180 | HPR280

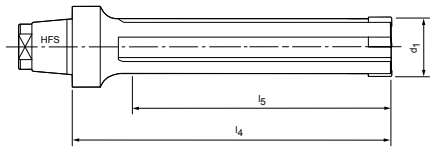

Dimensiones de la herramienta

	ød ₁	l ₄	l ₅	Tamaño HFS	z
HPR130 131 HPR230 231	7,000 - 9,590	60	45	12	4
	9,600 - 18,590	60	45	12	6
HPR180 HPR280	7,000 - 14,590	60	40	12	4
	14,600 - 21,290	60	40	12	6
HPR100 HPR110	15,600 - 18,590	14	-	10	6
	18,600 - 21,290	14,5	-	12	6
	21,300 - 23,990	15,5	-	14	6
	24,000 - 29,990	16	-	16	6
	30,000 - 39,990	17	-	20	8
	40,000 - 50,700	19	-	24	8
HPR150	50,710 - 65,000	25	-	24	8
	16,600 - 21,290	14	-	10	6
	21,300 - 24,990	15,5	-	12	6
	25,000 - 28,990	15,5	-	14	6
	29,000 - 36,990	17	-	16	6
	37,000 - 44,990	17	-	20	8
	45,000 - 50,700	19	-	24	8
50,710 - 65,000	25	-	24	8	

	ød ₁	l ₄	l ₅	Tamaño HFS	z
HPR200 HPR210	18,600 - 20,390	25	-	12	6
	20,400 - 21,290	27	-	12	6
	21,300 - 23,990	27	-	14	6
	24,000 - 29,990	35	-	16	6
	30,000 - 39,990	41	-	20	8
HPR250	40,000 - 65,000	47	-	24	8
	16,600 - 21,290	25	-	10	6
	21,300 - 24,990	27	-	12	6
	25,000 - 28,590	35	-	14	6
	29,000 - 32,290	35	-	16	6
	32,300 - 36,990	41	-	16	6
	37,000 - 41,190	41	-	20	8
	41,200 - 44,900	47	-	20	8
45,000 - 65,000	47	-	24	8	

Ejemplo de pedido:

Serie

Diámetro

Tolerancia



Escariador de cabezal intercambiable HPR

Ejecuciones:

- 1 = Escariador fijo
- 2 = Escariador de ajuste de precisión

Ángulo de hélice de los insertos:

- 0 = Con ranuras rectas hasta ø 65,000 mm
- 1 = Con ranuras oblicuas a la izquierda hasta ø 65,000 mm
- 3 = Con ranuras oblicuas a la izquierda hasta ø 18,590 mm
- 5 = Agujero ciego hasta ø 65,000 mm
- 8 = Agujero ciego hasta ø 21,290 mm

G = Indicación del diámetro de la herramienta
 Dígito solo utilizado para las variantes C y G

Diámetro del agujero o de la herramienta

IT o diferencias de medida en µm (ejemplo: +30+10) o, en la variante G, indicación de la tolerancia de fabricación del diámetro de afilado de la herramienta, por ejemplo, +3 µm

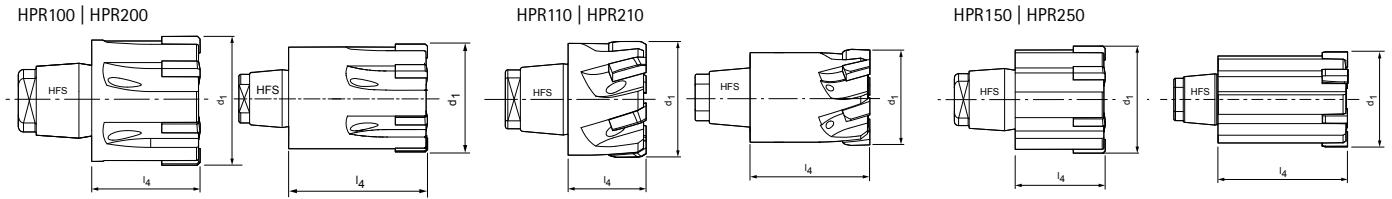

Tolerancias permitidas de la pieza para la selección del diámetro de la herramienta:

Ejecución fija

IT6 (16 µm) con Ø superior a ≥30,000 HPR

Si la tolerancia del diámetro de la pieza es menor que la clase de tolerancia mencionada anteriormente, se puede seleccionar una ejecución de ajuste de precisión o una ejecución fija como variante G (diámetro especial de la herramienta).

Ejecución de ajuste de precisión

IT5 (11 µm) con Ø superior a ≥30,000 HPR

Si la tolerancia del diámetro de la pieza es menor que la clase de tolerancia mencionada anteriormente, se puede seleccionar una ejecución de ajuste de precisión como variante G (diámetro especial de la herramienta).

Ejecución variante G

La variante G indica el diámetro de la herramienta del escariador con nuestras tolerancias de fabricación.

Tolerancias para la variante G/variante fija HPR1XX:

Material de corte	Rango de diámetros	
	7 - <60	≥60 - 65
Sin recubrimiento		
HU612		
CU134	-0,003	-0,006
CU130		
PU620		
Recubrimiento (grosor de la capa 1 – 2 µm)		
HP421		
CP134	-0,005	-0,008
HP625		
Recubrimiento (grosor de la capa 2 – 4 µm)		
HP423		
HP463	-0,007	-0,010
CP132		
CP233		
Recubrimiento (grosor de la capa 3 – 5 µm)		
HC412		
HC413	-0,007	-0,010
HC419		

Tolerancias para la variante G/variante de ajuste de precisión HPR2XX:

Medida de ajuste general +/-0,001

Entrada [Lead]

Material de corte [Cut]

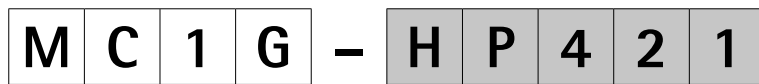

Forma de entrada y ángulo de desprendimiento:

MC1G ME1G Para la explicación de las geometrías de entrada, véase la página 752.
 MA0A ML2G
 MO2G MF1G

Material de corte:

HP421 CU134
 HP422 HP625
 HP423 HC419
 CP134 PU620

Escariador de cabezal intercambiable HPR

Ejecución fija, con ranuras rectas, para agujero pasante
HPR130

Ejecución:

Diámetro del escariador: 7,000 - 18,590 mm
Entrada: MC1G
Material de corte: CP134
Cermet con recubrimiento de PVD

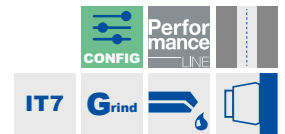
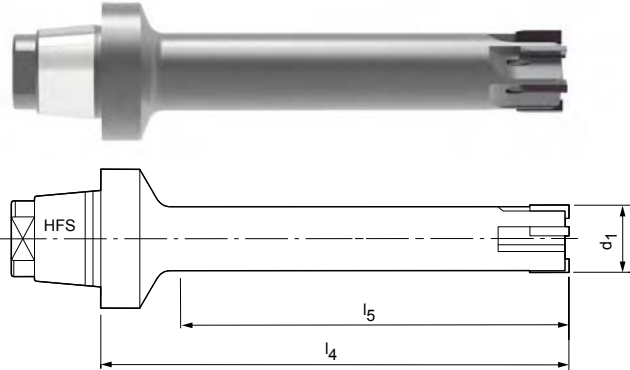

Características configurables



Tolerancia de diámetro del agujero IT7:

- Diámetro seleccionable libremente en incrementos de 0,001 mm
- Se puede pedir en tolerancia IT7

Especificación

HPR130Ø[diámetro][tolerancia]MC1G-CP134

Tolerancia de diámetro del agujero < IT7:

- Las tolerancias inferiores a IT7 pueden pedirse como diámetro de herramienta especial (para la variante G, véase la página 373)

Especificación de la variante G:

HPR130GØ[diámetro][tolerancia]MC1G-CP134

Dimensiones de la serie configurable IT7

d_1	l_4	l_5	Tamaño HFS	z
7,000 - 9,590	60	45	12	4
9,600 - 18,590	60	45	12	6

Ejemplo de tolerancia IT7:

HPR130Ø16.350H7MC1G-CP134

Diámetro del agujero $d_1 = 16,350$ H7

Ejemplo de variante G:

HPR130GØ16.350-5MC1G-CP134

Diámetro especial de la herramienta $d_1 = 16,350 -5 \mu\text{m}$

Medidas en mm.

* para superficies $R_a < 2 \mu\text{m}$

Para el correspondiente portaherramientas para cabezal intercambiables HFS, véase a partir de la página 460.

Para la recomendación de valores de corte, véase al final del capítulo.

Escariador de cabezal intercambiable HPR

Ejecución fija, con ranuras rectas, para agujero pasante
HPR130

Ejecución:

Diámetro del escariador: 7,000 - 18,590 mm

Entrada: MC1G

Material de corte:

HC419
Metal duro con recubrimiento CVD

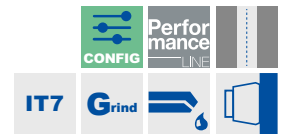
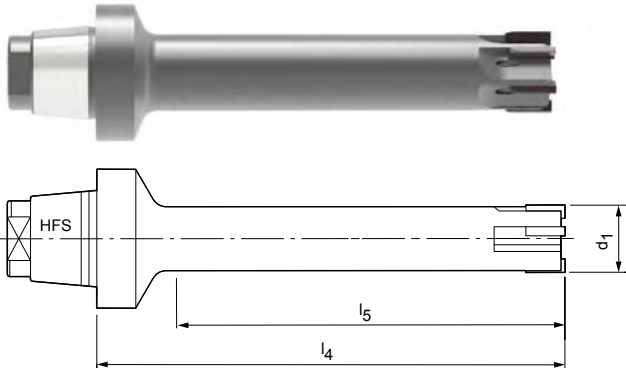

Características configurables



Tolerancia de diámetro del agujero IT7:

- Diámetro seleccionable libremente en incrementos de 0,001 mm
- Se puede pedir en tolerancia IT7

Especificación

HPR130Ø[diámetro][tolerancia]MC1G-HC419

Tolerancia de diámetro del agujero < IT7:

- Las tolerancias inferiores a IT7 pueden pedirse como diámetro de herramienta especial (para la variante G, véase la página 373)

Especificación de la variante G:

HPR130GØ[diámetro][tolerancia]MC1G-HC419

Dimensiones de la serie configurable IT7

d_1	l_4	l_5	Tamaño HFS	z
7,000 - 9,590	60	45	12	4
9,600 - 18,590	60	45	12	6

Ejemplo de tolerancia IT7:

HPR130Ø16.350H7MC1G-HC419

Diámetro del agujero $d_1 = 16,350$ H7

Ejemplo de variante G:

HPR130GØ16.350-7MC1G-HC419

Diámetro especial de la herramienta $d_1 = 16,350 - 7 \mu\text{m}$

Medidas en mm.

* para superficies $R_a < 2 \mu\text{m}$

Para el correspondiente portaherramientas para cabezal intercambiables HFS, véase a partir de la página 460.

Para la recomendación de valores de corte, véase al final del capítulo.

Escariador de cabezal intercambiable HPR

Ejecución fija, con ranuras rectas, para agujero pasante
HPR130

Ejecución:

Diámetro del escariador: 7,000 - 18,590 mm
Entrada: MC1G
Material de corte: HP421
Metal duro con recubrimiento de PVD

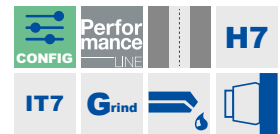
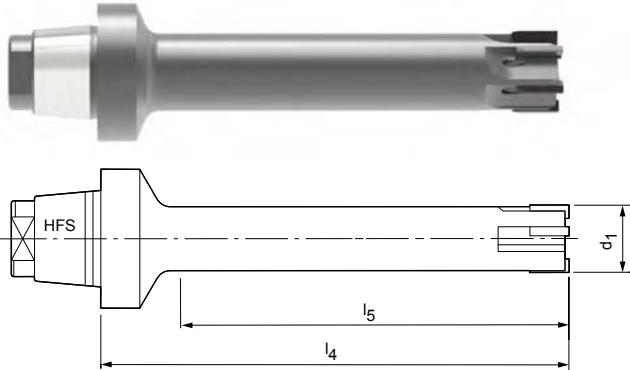

Serie preferente disponible en stock en H7

d ₁ H7	Tamaño HFS	Dimensiones			Especificación	Referencia
		l ₄	l ₅	z		
10,000	12	60	45	6	HPR130Ø10H7MC1G-HP421	30058428
12,000	12	60	45	6	HPR130Ø12H7MC1G-HP421	30201261
14,000	12	60	45	6	HPR130Ø14H7MC1G-HP421	30710146
16,000	12	60	45	6	HPR130Ø16H7MC1G-HP421	30710148
18,000	12	60	45	6	HPR130Ø18H7MC1G-HP421	30156684

Características configurables



Tolerancia de diámetro del agujero IT7:

- Diámetro seleccionable libremente en incrementos de 0,001 mm
- Se puede pedir en tolerancia IT7

Especificación

HPR130Ø[diámetro][tolerancia]MC1G-HP421

Tolerancia de diámetro del agujero < IT7:

- Las tolerancias inferiores a IT7 pueden pedirse como diámetro de herramienta especial (para la variante G, véase la página 373)

Especificación de la variante G:

HPR130GØ[diámetro][tolerancia]MC1G-HP421

Dimensiones de la serie configurable IT7

d ₁	l ₄	l ₅	Tamaño HFS	z
7,000 - 9,590	60	45	12	4
9,600 - 18,590	60	45	12	6

Ejemplo de tolerancia IT7:

HPR130Ø16.350H7MC1G-HP421

Diámetro del agujero d₁ = 16,350 H7

Ejemplo de variante G:

HPR130GØ16.350-5MC1G-HP421

Diámetro especial de la herramienta d₁ = 16,350 -5 μm

Medidas en mm.

Para el correspondiente portaherramientas para cabezal intercambiables HFS, véase a partir de la página 460.

Para la recomendación de valores de corte, véase al final del capítulo.

Escariador de cabezal intercambiable HPR

Ejecución fija, con ranuras rectas, para agujero pasante
HPR130

Ejecución:

Diámetro del escariador: 7,000 - 18,590 mm
Entrada: MC1G
Material de corte: HP423
Metal duro con recubrimiento de PVD

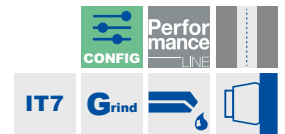
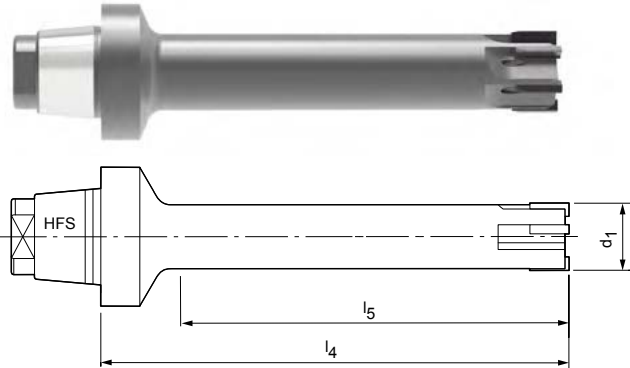

Características configurables



Tolerancia de diámetro del agujero IT7:

- Diámetro seleccionable libremente en incrementos de 0,001 mm
- Se puede pedir en tolerancia IT7

Especificación

HPR130Ø[diámetro][tolerancia]MC1G-HP423

Tolerancia de diámetro del agujero < IT7:

- Las tolerancias inferiores a IT7 pueden pedirse como diámetro de herramienta especial (para la variante G, véase la página 373)

Especificación de la variante G:

HPR130GØ[diámetro][tolerancia]MC1G-HP423

Dimensiones de la serie configurable IT7

d_1	l_4	l_5	Tamaño HFS	z
7,000 - 9,590	60	45	12	4
9,600 - 18,590	60	45	12	6

Ejemplo de tolerancia IT7:

HPR130Ø16.350H7MC1G-HP423

Diámetro del agujero $d_1 = 16,350$ H7

Ejemplo de variante G:

HPR130GØ16.350-8MC1G-HP423

Diámetro especial de la herramienta $d_1 = 16,350 - 7 \mu\text{m}$

Medidas en mm.

Para el correspondiente portaherramientas para cabezal intercambiables HFS, véase a partir de la página 460.

Para la recomendación de valores de corte, véase al final del capítulo.

Escariador de cabezal intercambiable HPR

Ejecución fija, con ranuras rectas, para agujero pasante
HPR130

Ejecución:
 Diámetro del escariador: 7,000 - 18,590 mm
 Entrada: MA0A
 Material de corte: PU620
 De PCD

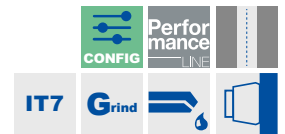
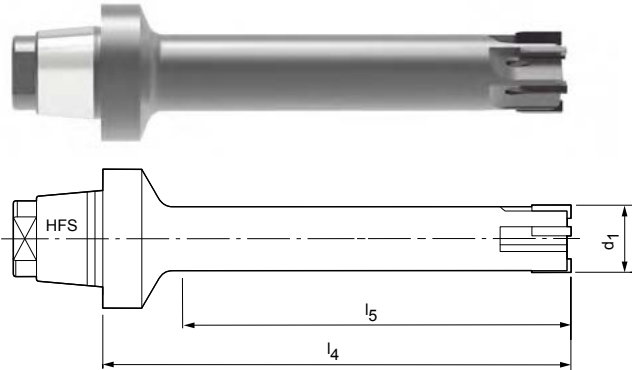

Características configurables



Tolerancia de diámetro del agujero IT7:
 - Diámetro seleccionable libremente en incrementos de 0,001 mm
 - Se puede pedir en tolerancia IT7

Especificación
 HPR130Ø[diámetro][tolerancia]MA0A-PU620

Tolerancia de diámetro del agujero < IT7:
 - Las tolerancias inferiores a IT7 pueden pedirse como diámetro de herramienta especial (para la variante G, véase la página 373)

Especificación de la variante G:
 HPR130GØ[diámetro][tolerancia]MA0A-PU620

Dimensiones de la serie configurable IT7

d ₁	l ₄	l ₅	Tamaño HFS	z
7,000 - 9,590	60	45	12	4
9,600 - 18,590	60	45	12	6

Ejemplo de tolerancia IT7:
 HPR130Ø16.350H7MA0A-PU620

Diámetro del agujero d₁ = 16,350 H7

Ejemplo de variante G:
 HPR130GØ16.350-3MA0A-PU620

Diámetro especial de la herramienta d₁ = 16,350 -3 µm

Medidas en mm.
 Para el correspondiente portaherramientas para cabezal intercambiables HFS, véase a partir de la página 460.
 Para la recomendación de valores de corte, véase al final del capítulo.

Escariador de cabezal intercambiable HPR

Ejecución fija, con ranuras oblicuas a la izquierda, para agujeros pasantes
HPR131

Ejecución:

Diámetro del escariador: 7,000 - 18,590 mm
Entrada: ME1G
Material de corte: CU134
Cermet sin recubrimiento

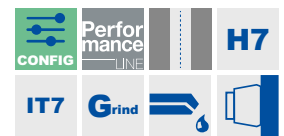
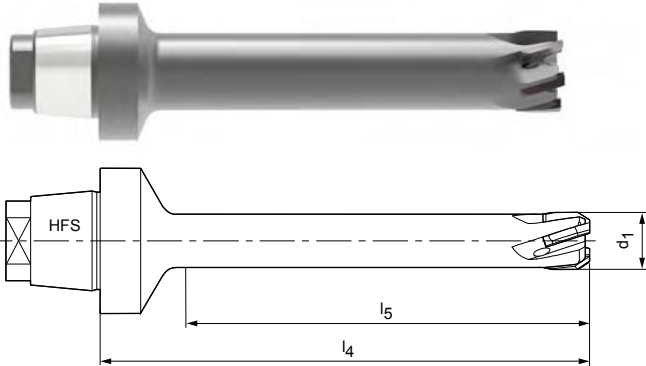

Serie preferente disponible en stock en H7

d ₁ H7	Tamaño HFS	Dimensiones			Especificación	Referencia
		l ₄	l ₅	z		
10,000	12	60	45	6	HPR131Ø10H7ME1G-CU134	30043741
11,000	12	60	45	6	HPR131Ø11H7ME1G-CU134	30087260
12,000	12	60	45	6	HPR131Ø12H7ME1G-CU134	30041656
13,000	12	60	45	6	HPR131Ø13H7ME1G-CU134	30057835
14,000	12	60	45	6	HPR131Ø14H7ME1G-CU134	30082580
16,000	12	60	45	6	HPR131Ø16H7ME1G-CU134	30047996
18,000	12	60	45	6	HPR131Ø18H7ME1G-CU134	30048997

Características configurables



Tolerancia de diámetro del agujero IT7:

- Diámetro seleccionable libremente en incrementos de 0,001 mm
- Se puede pedir en tolerancia IT7

Especificación

HPR131Ø[diámetro][tolerancia]ME1G-CU134

Tolerancia de diámetro del agujero < IT7:

- Las tolerancias inferiores a IT7 pueden pedirse como diámetro de herramienta especial (para la variante G, véase la página 373)

Especificación de la variante G:

HPR131GØ[diámetro][tolerancia]ME1G-CU134

Dimensiones de la serie configurable IT7

d ₁	l ₄	l ₅	Tamaño HFS	z
7,000 - 9,590	60	45	12	4
9,600 - 18,590	60	45	12	6

Ejemplo de tolerancia IT7:

HPR131Ø16.350H7ME1G-CU134

Diámetro del agujero d₁ = 16,350 H7

Ejemplo de variante G:

HPR131GØ16.350-3ME1G-CU134

Diámetro especial de la herramienta d₁ = 16,350 -3 µm

Medidas en mm.

Para el correspondiente portaherramientas para cabezal intercambiables HFS, véase a partir de la página 460.

Para la recomendación de valores de corte, véase al final del capítulo.

Escariador de cabezal intercambiable HPR

Ejecución fija, con ranuras oblicuas a la izquierda, para agujeros pasantes HPR131

Ejecución:

Diámetro del escariador: 7,000 - 18,590 mm

Entrada: ME1G

Material de corte:

HP421
Metal duro con recubrimiento de PVD

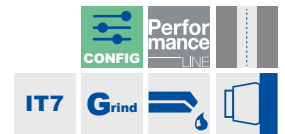
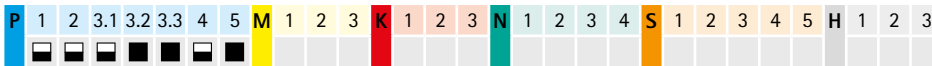
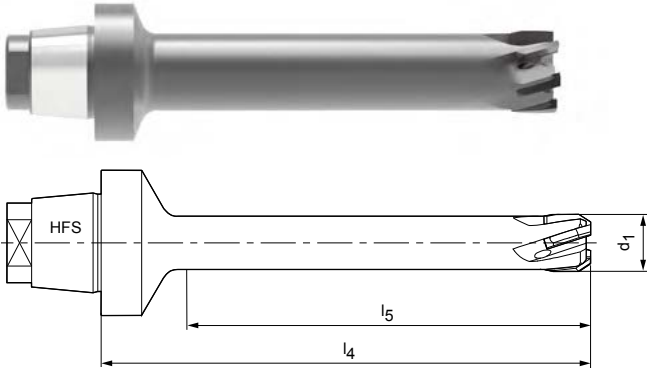

Características configurables



Tolerancia de diámetro del agujero IT7:

- Diámetro seleccionable libremente en incrementos de 0,001 mm
- Se puede pedir en tolerancia IT7

Especificación

HPR131Ø[diámetro][tolerancia]ME1G-HP421

Tolerancia de diámetro del agujero < IT7:

- Las tolerancias inferiores a IT7 pueden pedirse como diámetro de herramienta especial (para la variante G, véase la página 373)

Especificación de la variante G:

HPR131GØ[diámetro][tolerancia]ME1G-HP421

Dimensiones de la serie configurable IT7

d ₁	l ₄	l ₅	Tamaño HFS	z
7,000 - 9,590	60	45	12	4
9,600 - 18,590	60	45	12	6

Ejemplo de tolerancia IT7:

HPR131Ø16.350H7ME1G-HP421

Diámetro del agujero d₁ = 16,350 H7

Ejemplo de variante G:

HPR131GØ16.350-5ME1G-HP421

Diámetro especial de la herramienta d₁ = 16,350 -5 μm

Medidas en mm.

Para el correspondiente portaherramientas para cabezal intercambiables HFS, véase a partir de la página 460.

Para la recomendación de valores de corte, véase al final del capítulo.

Escariador de cabezal intercambiable HPR

Ejecución fija, con ranuras oblicuas a la izquierda, para agujeros pasantes
HPR131

Ejecución:

Diámetro del escariador: 7,000 - 18,590 mm
Entrada: MF1G
Material de corte: HP421
Metal duro con recubrimiento de PVD

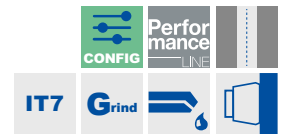
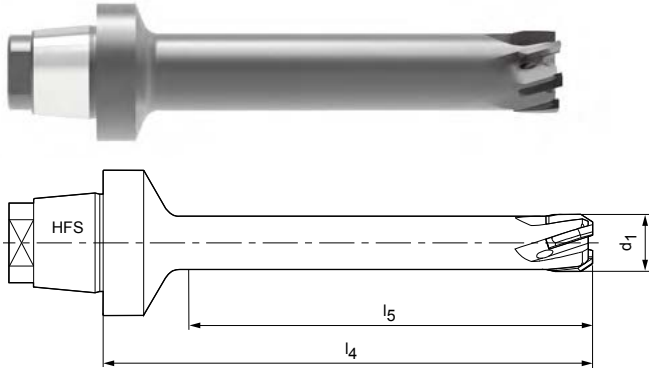

Serie preferentes en stock en H7

d ₁ H7	Tamaño HFS	Dimensiones			Especificación	Referencia
		l ₄	l ₅	z		
10,000	12	60	45	6	HPR131Ø10.00H7MF1G-HP421	30710160
11,000	12	60	45	6	HPR131Ø11.00H7MF1G-HP421	30710161
12,000	12	60	45	6	HPR131Ø12.00H7MF1G-HP421	30710162
13,000	12	60	45	6	HPR131Ø13.00H7MF1G-HP421	30710163
14,000	12	60	45	6	HPR131Ø14.00H7MF1G-HP421	30710164
16,000	12	60	45	6	HPR131Ø16.00H7MF1G-HP421	30710166
18,000	12	60	45	6	HPR131Ø18.00H7MF1G-HP421	30710168

Características configurables



Tolerancia de diámetro del agujero IT7:

- Diámetro seleccionable libremente en incrementos de 0,001 mm
- Se puede pedir en tolerancia IT7

Especificación

HPR131Ø[diámetro][tolerancia]MF1G-HP421

Tolerancia de diámetro del agujero < IT7:

- Las tolerancias inferiores a IT7 pueden pedirse como diámetro de herramienta especial (para la variante G, véase la página 373)

Especificación de la variante G:

HPR131GØ[diámetro][tolerancia]MF1G-HP421

Dimensiones de la serie configurable IT7

d ₁	l ₄	l ₅	Tamaño HFS	z
7,000 - 9,590	60	45	12	4
9,600 - 18,590	60	45	12	6

Ejemplo de tolerancia IT7:

HPR131Ø16.350H7MF1G-HP421

Diámetro del agujero d₁ = 16,350 H7

Ejemplo de variante G:

HPR131GØ16.350-5MF1G-HP421

Diámetro especial de la herramienta d₁ = 16,350 -5 μm

Medidas en mm.

Para el correspondiente portaherramientas para cabezal intercambiables HFS, véase a partir de la página 460.

Para la recomendación de valores de corte, véase al final del capítulo.

Escariador de cabezal intercambiable HPR

Ejecución fija, con ranuras oblicuas a la izquierda, para agujeros pasantes HPR131

Ejecución:

Diámetro del escariador: 7,000 - 18,590 mm
 Entrada: MF1G
 Material de corte: HP625
 Metal duro con recubrimiento de PVD

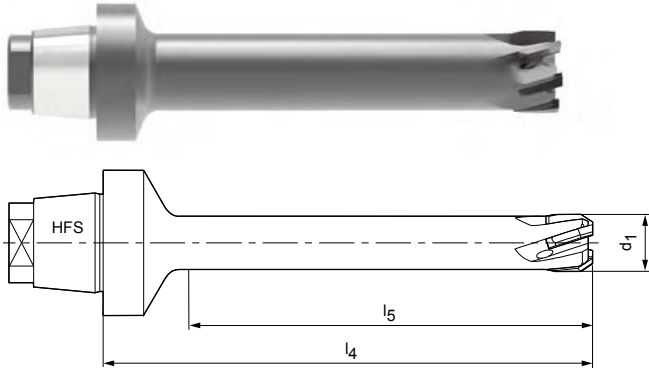

Características configurables



Tolerancia de diámetro del agujero IT7:
 - Diámetro seleccionable libremente en incrementos de 0,001 mm
 - Se puede pedir en tolerancia IT7

Especificación
 HPR131Ø[diámetro][tolerancia]MF1G-HP625

Tolerancia de diámetro del agujero < IT7:
 - Las tolerancias inferiores a IT7 pueden pedirse como diámetro de herramienta especial (para la variante G, véase la página 373)

Especificación de la variante G:
 HPR131GØ[diámetro][tolerancia]MF1G-HP625

Dimensiones de la serie configurable IT7

d ₁	l ₄	l ₅	Tamaño HFS	z
7,000 - 9,590	60	45	12	4
9,600 - 18,590	60	45	12	6

Ejemplo de tolerancia IT7:
 HPR131Ø16.350H7MF1G-HP625

Diámetro del agujero d₁ = 16,350 H7

Ejemplo de variante G:
 HPR131GØ16.350-7MF1G-HP625

Diámetro especial de la herramienta d₁ = 16,350 -5 µm

Medidas en mm.
 Para el correspondiente portaherramientas para cabezal intercambiables HFS, véase a partir de la página 460.
 Para la recomendación de valores de corte, véase al final del capítulo.

Escariador de cabezal intercambiable HPR

Ejecución fija, con ranuras rectas, para agujero pasante HPR100

Ejecución:

Diámetro del escariador: 15,600 - 65,000 mm
 Entrada: MC1G
 Material de corte: CP134
 Cermet con recubrimiento de PVD

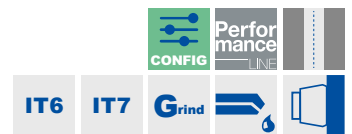
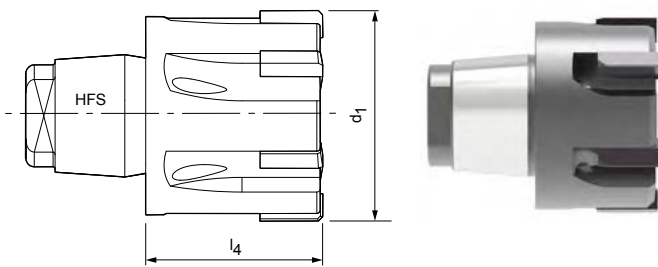

Características configurables



Tolerancia de diámetro del agujero IT6/IT7:

- Diámetro seleccionable libremente en incrementos de 0,001 mm
- En función del rango de diámetros, se puede pedir a partir de la tolerancia IT6/IT7
- > Ø30,000 IT6 | ≤ Ø30,000 IT7

Especificación

HPR100Ø[diámetro][tolerancia]MC1G-CP134

Tolerancia de diámetro del agujero < IT6/IT7:

- Las tolerancias inferiores a IT6/IT7 pueden pedirse como diámetro de herramienta especial (para la variante G, véase la página 373)

Especificación de la variante G:

HPR100GØ[diámetro][tolerancia]MC1G-CP134

Dimensiones de la serie configurable IT6/IT7

d1	l ₄	l ₅	Tamaño HFS	z	Tolerancia
15,600 - 18,590	14	-	10	6	IT7
18,600 - 21,290	14,5	-	12	6	IT7
21,300 - 23,990	15,5	-	14	6	IT7
24,000 - 29,990	16	-	16	6	IT7
30,000 - 39,990	17	-	20	8	IT6
40,000 - 50,700	19	-	24	8	IT6
50,710 - 65,000	25	-	24	8	IT6

Ejemplo de tolerancia IT7:

HPR100Ø16.350H7MC1G-CP134

Diámetro del agujero d₁ = 16,350 H7

Ejemplo de variante G:

HPR100GØ16.350-5MC1G-CP134

Diámetro especial de la herramienta d₁ = 16,350 -5 μm

Medidas en mm.

* para superficies R_a < 2 μm

Para el correspondiente portaherramientas para cabezal intercambiables HFS, véase a partir de la página 460.

Para la recomendación de valores de corte, véase al final del capítulo.

Escariador de cabezal intercambiable HPR

Ejecución fija, con ranuras rectas, para agujero pasante
HPR100

Ejecución:

Diámetro del escariador: 15,600 - 65,000 mm
Entrada: MC1G
Material de corte: HC419
Metal duro con recubrimiento CVD

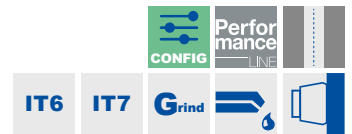
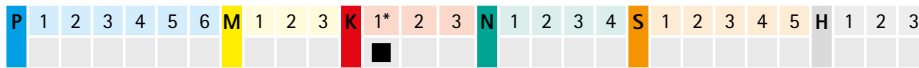
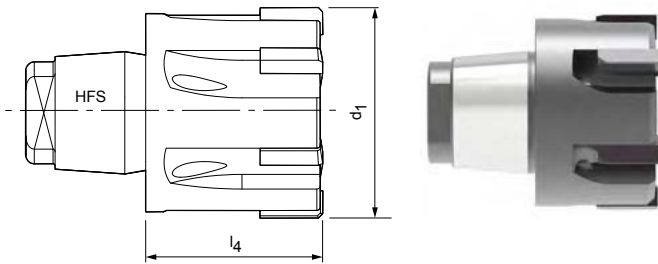

Características configurables



Tolerancia de diámetro del agujero IT6/IT7:

- Diámetro seleccionable libremente en incrementos de 0,001 mm
- En función del rango de diámetros, se puede pedir a partir de la tolerancia IT6/IT7
- > Ø30,000 IT6 | ≤ Ø30,000 IT7

Especificación

HPR100Ø[diámetro][tolerancia]MC1G-HC419

Tolerancia de diámetro del agujero < IT6/IT7:

- Las tolerancias inferiores a IT6/IT7 pueden pedirse como diámetro de herramienta especial (para la variante G, véase la página 373)

Especificación de la variante G:

HPR100GØ[diámetro][tolerancia]MC1G-HC419

Dimensiones de la serie configurable IT6/IT7

d1	l ₄	l ₅	Tamaño HFS	z	Tolerancia
15,600 - 18,590	14	-	10	6	IT7
18,600 - 21,290	14,5	-	12	6	IT7
21,300 - 23,990	15,5	-	14	6	IT7
24,000 - 29,990	16	-	16	6	IT7
30,000 - 39,990	17	-	20	8	IT6
40,000 - 50,700	19	-	24	8	IT6
50,710 - 65,000	25	-	24	8	IT6

Ejemplo de tolerancia IT7:

HPR100Ø16.350H7MC1G-HC419

Diámetro del agujero d₁ = 16,350 H7

Ejemplo de variante G:

HPR100GØ16.350-7MC1G-HC419

Diámetro especial de la herramienta d₁ = 16,350 -7 μm

Medidas en mm.

* para superficies Ra < 2 μm

Para el correspondiente portaherramientas para cabezal intercambiables HFS, véase a partir de la página 460.

Para la recomendación de valores de corte, véase al final del capítulo.



Escariador de cabezal intercambiable HPR

Ejecución fija, con ranuras rectas, para agujero pasante
HPR100

Ejecución:

Diámetro del escariador: 15,600 - 65,000 mm

Entrada: MC1G

Material de corte:

HP421
Metal duro con recubrimiento de PVD

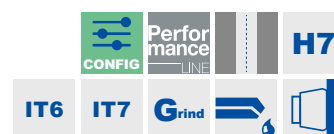
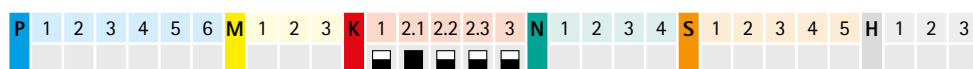
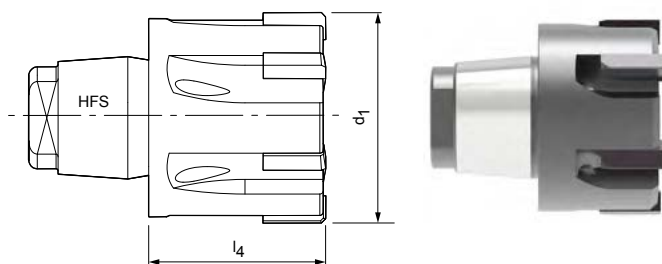

Serie preferente disponible en stock en H7

d ₁ H7	Tamaño HFS	Dimensiones		Especificación	Referencia
		l ₄	z		
19,000	12	14,5	6	HPR100Ø19H7MC1G-HP421	30037777
20,000	12	14,5	6	HPR100Ø20H7MC1G-HP421	30191340
22,000	14	15,5	6	HPR100Ø22H7MC1G-HP421	30368857
24,000	16	16	6	HPR100Ø24H7MC1G-HP421	30181729
25,000	16	16	6	HPR100Ø25H7MC1G-HP421	30537929
26,000	16	16	6	HPR100Ø26H7MC1G-HP421	30076945
28,000	16	16	6	HPR100Ø28H7MC1G-HP421	30025212
30,000	20	17	8	HPR100Ø30H7MC1G-HP421	30031345
32,000	20	17	8	HPR100Ø32H7MC1G-HP421	30438453
35,000	20	17	8	HPR100Ø35H7MC1G-HP421	30537930
40,000	24	19	8	HPR100Ø40H7MC1G-HP421	30083953
45,000	24	19	8	HPR100Ø45H7MC1G-HP421	30537931
50,000	24	19	8	HPR100Ø50H7MC1G-HP421	30710245
55,000	24	25	8	HPR100Ø55H7MC1G-HP421	30419154
60,000	24	25	8	HPR100Ø60H7MC1G-HP421	30350208
65,000	24	25	8	HPR100Ø65H7MC1G-HP421	30272888

Medidas en mm.

Para el correspondiente portaherramientas para cabezal intercambiables HFS, véase a partir de la página 460.

Para la recomendación de valores de corte, véase al final del capítulo.

HPR100 | Ejecución fija, con ranuras rectas

Características configurables

**Tolerancia de diámetro del agujero IT6/IT7:**

- Diámetro seleccionable libremente en incrementos de 0,001 mm
- En función del rango de diámetros, se puede pedir a partir de la tolerancia IT6/IT7
- > Ø30,000 IT6 | ≤ Ø30,000 IT7

Especificación

HPR100Ø[diámetro][tolerancia]MC1G-HP421

Tolerancia de diámetro del agujero < IT6/IT7:

- Las tolerancias inferiores a IT6/IT7 pueden pedirse como diámetro de herramienta especial (para la variante G, véase la página 373)

Especificación de la variante G:

HPR100GØ[diámetro][tolerancia]MC1G-HP421

Dimensiones de la serie configurable IT6/IT7

d1	l ₄	l ₅	Tamaño HFS	z	Tolerancia
15,600 - 18,590	14	-	10	6	IT7
18,600 - 21,290	14,5	-	12	6	IT7
21,300 - 23,990	15,5	-	14	6	IT7
24,000 - 29,990	16	-	16	6	IT7
30,000 - 39,990	17	-	20	8	IT6
40,000 - 50,700	19	-	24	8	IT6
50,710 - 65,000	25	-	24	8	IT6

Ejemplo de tolerancia IT7:

HPR100Ø16.350H7MC1G-HP421

Diámetro del agujero d₁ = 16,350 H7**Ejemplo de variante G:**

HPR100GØ16.350-5MC1G-HP421

Diámetro especial de la herramienta d₁ = 16,350 -5 µm

Medidas en mm.

Para el correspondiente portaherramientas para cabezal intercambiables HFS, véase a partir de la página 460.

Para la recomendación de valores de corte, véase al final del capítulo.

Escariador de cabezal intercambiable HPR

Ejecución fija, con ranuras rectas, para agujero pasante HPR100

Ejecución:
 Diámetro del escariador: 15,600 - 65,000 mm
 Entrada: MC1G
 Material de corte: HP423
 Metal duro con recubrimiento de PVD

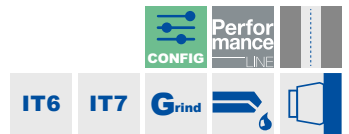
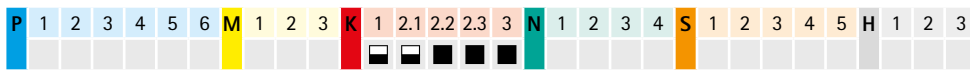
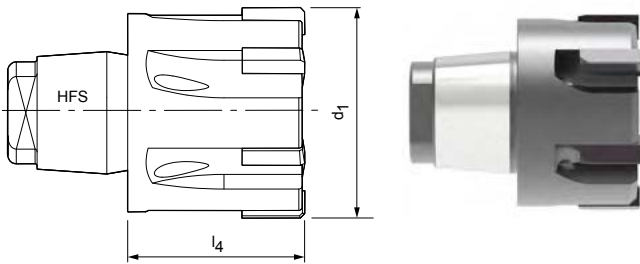

Características configurables



Tolerancia de diámetro del agujero IT6/IT7:
 - Diámetro seleccionable libremente en incrementos de 0,001 mm
 - En función del rango de diámetros, se puede pedir a partir de la tolerancia IT6/IT7
 - > Ø30,000 IT6 | ≤ Ø30,000 IT7

Especificación
 HPR100Ø[diámetro][tolerancia]MC1G-HP423

Tolerancia de diámetro del agujero < IT6/IT7:
 - Las tolerancias inferiores a IT6/IT7 pueden pedirse como diámetro de herramienta especial (para la variante G, véase la página 373)

Especificación de la variante G:
 HPR100GØ[diámetro][tolerancia]MC1G-HP423

Dimensiones de la serie configurable IT6/IT7

d1	l4	l5	Tamaño HFS	z	Tolerancia
15,600 - 18,590	14	-	10	6	IT7
18,600 - 21,290	14,5	-	12	6	IT7
21,300 - 23,990	15,5	-	14	6	IT7
24,000 - 29,990	16	-	16	6	IT7
30,000 - 39,990	17	-	20	8	IT6
40,000 - 50,700	19	-	24	8	IT6
50,710 - 65,000	25	-	24	8	IT6

Ejemplo de tolerancia IT7:
 HPR100Ø16.350H7MC1G-HP423

Diámetro del agujero d₁ = 16,350 H7

Ejemplo de variante G:
 HPR100GØ16.350-8MC1G-HP423

Diámetro especial de la herramienta d₁ = 16,350 -7 µm

Medidas en mm.
 Para el correspondiente portaherramientas para cabezal intercambiables HFS, véase a partir de la página 460.
 Para la recomendación de valores de corte, véase al final del capítulo.

Escariador de cabezal intercambiable HPR

Ejecución fija, con ranuras rectas, para agujero pasante
HPR100

Ejecución:

Diámetro del escariador: 15,600 - 65,000 mm
Entrada: MA0A
Material de corte: PU620
De PCD

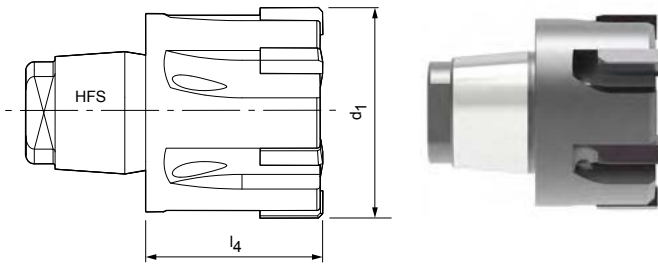

Características configurables



Tolerancia de diámetro del agujero IT6/IT7:

- Diámetro seleccionable libremente en incrementos de 0,001 mm
- En función del rango de diámetros, se puede pedir a partir de la tolerancia IT6/IT7
- > Ø30,000 IT6 | ≤ Ø30,000 IT7

Especificación

HPR100Ø[diámetro][tolerancia]MA0A-PU620

Tolerancia de diámetro del agujero < IT6/IT7:

- Las tolerancias inferiores a IT6/IT7 pueden pedirse como diámetro de herramienta especial (para la variante G, véase la página 373)

Especificación de la variante G:

HPR100GØ[diámetro][tolerancia]MA0A-PU620

Dimensiones de la serie configurable IT6/IT7

d1	l ₄	l ₅	Tamaño HFS	z	Tolerancia
15,600 - 18,590	14	-	10	6	IT7
18,600 - 21,290	14,5	-	12	6	IT7
21,300 - 23,990	15,5	-	14	6	IT7
24,000 - 29,990	16	-	16	6	IT7
30,000 - 39,990	17	-	20	8	IT6
40,000 - 50,700	19	-	24	8	IT6
50,710 - 65,000	25	-	24	8	IT6

Ejemplo de tolerancia IT7:

HPR100Ø16.350H7MA0A-PU620

Diámetro del agujero d₁ = 16,350 H7

Ejemplo de variante G:

HPR100GØ16.350-3MA0A-PU620

Diámetro especial de la herramienta d₁ = 16,350 -3 μm

Medidas en mm.

Para el correspondiente portaherramientas para cabezal intercambiables HFS, véase a partir de la página 460.

Para la recomendación de valores de corte, véase al final del capítulo.

Escariador de cabezal intercambiable HPR

Ejecución fija, con ranuras oblicuas a la izquierda, para agujeros pasantes
HPR110

Ejecución:

Diámetro del escariador: 15,600 - 65,000 mm
Entrada: ME1G
Material de corte: CU134
Cermet sin recubrimiento

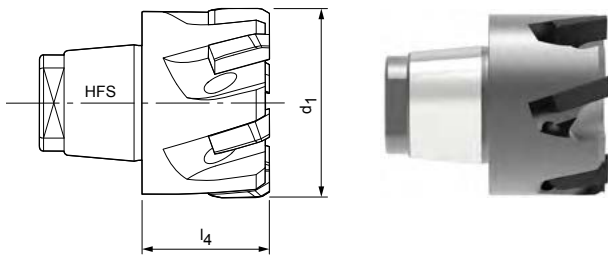

Serie preferente disponible en stock en H7

d ₁ H7	Tamaño HFS	Dimensiones		Especificación	Referencia
		l ₄	z		
19,000	12	14,5	6	HPR110Ø19H7ME1G-CU134	30077358
20,000	12	14,5	6	HPR110Ø20H7ME1G-CU134	30040404
21,000	12	14,5	6	HPR110Ø21H7ME1G-CU134	30039919
22,000	14	15,5	6	HPR110Ø22H7ME1G-CU134	30081546
23,000	14	15,5	6	HPR110Ø23H7ME1G-CU134	30085368
24,000	16	16	6	HPR110Ø24H7ME1G-CU134	30080958
25,000	16	16	6	HPR110Ø25H7ME1G-CU134	30076110
26,000	16	16	6	HPR110Ø26H7ME1G-CU134	30045730
27,000	16	16	6	HPR110Ø27H7ME1G-CU134	30087257
28,000	16	16	6	HPR110Ø28H7ME1G-CU134	30046121
30,000	20	17	8	HPR110Ø30H7ME1G-CU134	30045095
31,000	20	17	8	HPR110Ø31H7ME1G-CU134	30192960
32,000	20	17	8	HPR110Ø32H7ME1G-CU134	30084530
33,000	20	17	8	HPR110Ø33H7ME1G-CU134	30162282
34,000	20	17	8	HPR110Ø34H7ME1G-CU134	30043743
35,000	20	17	8	HPR110Ø35H7ME1G-CU134	30084885
39,000	20	17	8	HPR110Ø39H7ME1G-CU134	30088042
40,000	24	19	8	HPR110Ø40H7ME1G-CU134	30045097
42,000	24	19	8	HPR110Ø42H7ME1G-CU134	30080437
44,000	24	19	8	HPR110Ø44H7ME1G-CU134	30097178
45,000	24	19	8	HPR110Ø45H7ME1G-CU134	30049313
50,000	24	19	8	HPR110Ø50H7ME1G-CU134	30219386
55,000	24	25	8	HPR110Ø55H7ME1G-CU134	30196567
60,000	24	25	8	HPR110Ø60H7ME1G-CU134	30242416
65,000	24	25	8	HPR110Ø65H7ME1G-CU134	30236537

Medidas en mm.

Para el correspondiente portaherramientas para cabezal intercambiables HFS, véase a partir de la página 460.

Para la recomendación de valores de corte, véase al final del capítulo.

HPR110 | Ejecución fija, con ranuras oblicuas a la izquierda

Características configurables

**Tolerancia de diámetro del agujero IT6/IT7:**

- Diámetro seleccionable libremente en incrementos de 0,001 mm
- En función del rango de diámetros, se puede pedir a partir de la tolerancia IT6/IT7
- > Ø30,000 IT6 | ≤ Ø30,000 IT7

Especificación

HPR110Ø[diámetro][tolerancia]ME1G-CU134

Tolerancia de diámetro del agujero < IT6/IT7:

- Las tolerancias inferiores a IT6/IT7 pueden pedirse como diámetro de herramienta especial (para la variante G, véase la página 373)

Especificación de la variante G:

HPR110GØ[diámetro][tolerancia]ME1G-CU134

Dimensiones de la serie configurable IT6/IT7

d1	l ₄	l ₅	Tamaño HFS	z	Tolerancia
15,600 - 18,590	14	-	10	6	IT7
18,600 - 21,290	14,5	-	12	6	IT7
21,300 - 23,990	15,5	-	14	6	IT7
24,000 - 29,990	16	-	16	6	IT7
30,000 - 39,990	17	-	20	8	IT6
40,000 - 50,700	19	-	24	8	IT6
50,710 - 65,000	25	-	24	8	IT6

Ejemplo de tolerancia IT7:

HPR110Ø16.350H7ME1G-CU134

Diámetro del agujero d₁ = 16,350 H7**Ejemplo de variante G:**

HPR110GØ16.350-3ME1G-CU134

Diámetro especial de la herramienta d₁ = 16,350 -3 µm

Escariador de cabezal intercambiable HPR

Ejecución fija, con ranuras oblicuas a la izquierda, para agujeros pasantes HPR110

Ejecución:
 Diámetro del escariador: 15,600 - 65,000 mm
 Entrada: ME1G
 Material de corte: HP421
 Metal duro con recubrimiento de PVD

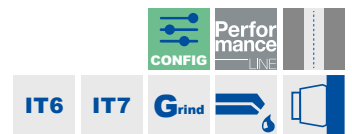
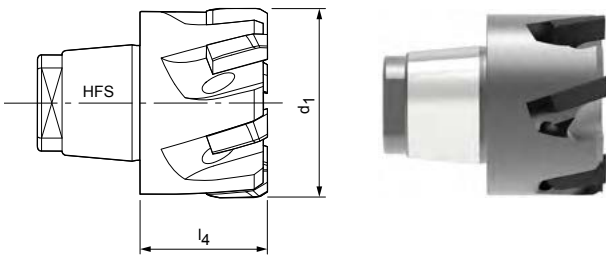

Características configurables



Tolerancia de diámetro del agujero IT6/IT7:
 - Diámetro seleccionable libremente en incrementos de 0,001 mm
 - En función del rango de diámetros, se puede pedir a partir de la tolerancia IT6/IT7
 - > Ø30,000 IT6 | ≤ Ø30,000 IT7

Especificación
 HPR110Ø[diámetro][tolerancia]ME1G-HP421

Tolerancia de diámetro del agujero < IT6/IT7:
 - Las tolerancias inferiores a IT6/IT7 pueden pedirse como diámetro de herramienta especial (para la variante G, véase la página 373)

Especificación de la variante G:
 HPR110GØ[diámetro][tolerancia]ME1G-HP421

Dimensiones de la serie configurable IT6/IT7

d1	l4	l5	Tamaño HFS	z	Tolerancia
15,600 - 18,590	14	-	10	6	IT7
18,600 - 21,290	14,5	-	12	6	IT7
21,300 - 23,990	15,5	-	14	6	IT7
24,000 - 29,990	16	-	16	6	IT7
30,000 - 39,990	17	-	20	8	IT6
40,000 - 50,700	19	-	24	8	IT6
50,710 - 65,000	25	-	24	8	IT6

Ejemplo de tolerancia IT7:
 HPR110Ø16.350H7ME1G-HP421

Diámetro del agujero d₁ = 16,350 H7

Ejemplo de variante G:
 HPR110GØ16.350-5ME1G-HP421

Diámetro especial de la herramienta d₁ = 16,350 -5 µm

Medidas en mm.
 Para el correspondiente portaherramientas para cabezal intercambiables HFS, véase a partir de la página 460.
 Para la recomendación de valores de corte, véase al final del capítulo.

Escariador de cabezal intercambiable HPR

Ejecución fija, con ranuras oblicuas a la izquierda, para agujeros pasantes
HPR110

Ejecución:

Diámetro del escariador: 15,600 - 65,000 mm
Entrada: MF1G
Material de corte: HP625
Metal duro con recubrimiento de PVD

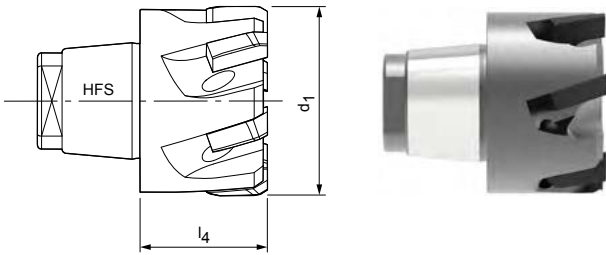

Características configurables



Tolerancia de diámetro del agujero IT6/IT7:

- Diámetro seleccionable libremente en incrementos de 0,001 mm
- En función del rango de diámetros, se puede pedir a partir de la tolerancia IT6/IT7
- > Ø30,000 IT6 | ≤ Ø30,000 IT7

Especificación

HPR110Ø[diámetro][tolerancia]MF1G-HP625

Tolerancia de diámetro del agujero < IT6/IT7:

- Las tolerancias inferiores a IT6/IT7 pueden pedirse como diámetro de herramienta especial (para la variante G, véase la página 373)

Especificación de la variante G:

HPR110GØ[diámetro][tolerancia]MF1G-HP625

Dimensiones de la serie configurable IT6/IT7

d1	l ₄	l ₅	Tamaño HFS	z	Tolerancia
15,600 - 18,590	14	-	10	6	IT7
18,600 - 21,290	14,5	-	12	6	IT7
21,300 - 23,990	15,5	-	14	6	IT7
24,000 - 29,990	16	-	16	6	IT7
30,000 - 39,990	17	-	20	8	IT6
40,000 - 50,700	19	-	24	8	IT6
50,710 - 65,000	25	-	24	8	IT6

Ejemplo de tolerancia IT7:

HPR110Ø16.350H7MF1G-HP625

Diámetro del agujero d₁ = 16,350 H7

Ejemplo de variante G:

HPR110GØ16.350-7MF1G-HP625

Diámetro especial de la herramienta d₁ = 16,350 -5 μm

Medidas en mm.

Para el correspondiente portaherramientas para cabezal intercambiables HFS, véase a partir de la página 460.

Para la recomendación de valores de corte, véase al final del capítulo.

Escariador de cabezal intercambiable HPR

Ejecución fija, con ranuras oblicuas a la izquierda, para agujeros pasantes HPR110

Ejecución:

Diámetro del escariador: 15,600 - 65,000 mm
 Entrada: MF1G
 Material de corte: HP421
 Metal duro con recubrimiento de PVD

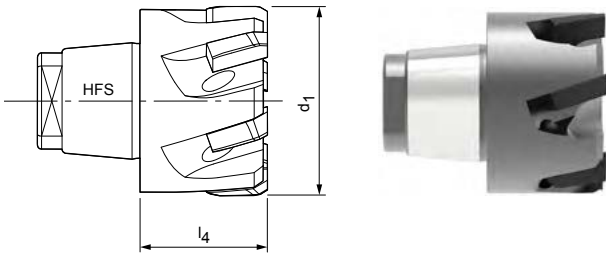

Serie preferente disponible en stock en H7

d ₁ H7	Tamaño HFS	Dimensiones		Especificación	Referencia
		l ₄	z		
19,000	12	14,5	6	HPR110Ø19H7MF1G-HP421	30710291
20,000	12	14,5	6	HPR110Ø20H7MF1G-HP421	30401369
22,000	14	15,5	6	HPR110Ø22H7MF1G-HP421	30710293
23,000	14	15,5	6	HPR110Ø23H7MF1G-HP421	30710294
24,000	16	16	6	HPR110Ø24H7MF1G-HP421	30710295
25,000	16	16	6	HPR110Ø25H7MF1G-HP421	30318503
26,000	16	16	6	HPR110Ø26H7MF1G-HP421	30710296
27,000	16	16	6	HPR110Ø27H7MF1G-HP421	30710297
28,000	16	16	6	HPR110Ø28H7MF1G-HP421	30710298
30,000	20	17	8	HPR110Ø30H7MF1G-HP421	30576508
31,000	20	17	8	HPR110Ø31H7MF1G-HP421	30710300
32,000	20	17	8	HPR110Ø32H7MF1G-HP421	30671985
33,000	20	17	8	HPR110Ø33H7MF1G-HP421	30710301
34,000	20	17	8	HPR110Ø34H7MF1G-HP421	30710302
35,000	20	17	8	HPR110Ø35H7MF1G-HP421	30710303
39,000	20	17	8	HPR110Ø39H7MF1G-HP421	30710307
40,000	24	19	8	HPR110Ø40H7MF1G-HP421	30498368

Medidas en mm.

Para el correspondiente portaherramientas para cabezal intercambiables HFS, véase a partir de la página 460.

Para la recomendación de valores de corte, véase al final del capítulo.

HPR110 | Ejecución fija, con ranuras oblicuas a la izquierda

Características configurables

**Tolerancia de diámetro del agujero IT6/IT7:**

- Diámetro seleccionable libremente en incrementos de 0,001 mm
- En función del rango de diámetros, se puede pedir a partir de la tolerancia IT6/IT7
- > Ø30,000 IT6 | ≤ Ø30,000 IT7

Especificación

HPR110Ø[diámetro][tolerancia]MF1G-HP421

Tolerancia de diámetro del agujero < IT6/IT7:

- Las tolerancias inferiores a IT6/IT7 pueden pedirse como diámetro de herramienta especial (para la variante G, véase la página 373)

Especificación de la variante G:

HPR110GØ[diámetro][tolerancia]MF1G-HP421

Dimensiones de la serie configurable IT6/IT7

d1	l ₄	l ₅	Tamaño HFS	z	Tolerancia
15,600 - 18,590	14	-	10	6	IT7
18,600 - 21,290	14,5	-	12	6	IT7
21,300 - 23,990	15,5	-	14	6	IT7
24,000 - 29,990	16	-	16	6	IT7
30,000 - 39,990	17	-	20	8	IT6
40,000 - 50,700	19	-	24	8	IT6
50,710 - 65,000	25	-	24	8	IT6

Ejemplo de tolerancia IT7:

HPR110Ø16.350H7MF1G-HP421

Diámetro del agujero d₁ = 16,350 H7**Ejemplo de variante G:**

HPR110GØ16.350-5MF1G-HP421

Diámetro especial de la herramienta d₁ = 16,350 -5 µm

Escariador de cabezal intercambiable HPR

Ejecución fija, con ranuras rectas, para agujeros ciegos
HPR180

Ejecución:

Diámetro del escariador: 7,000 - 21,290 mm
Entrada: ML2G
Material de corte: CU134
Cermet sin recubrimiento

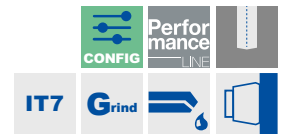
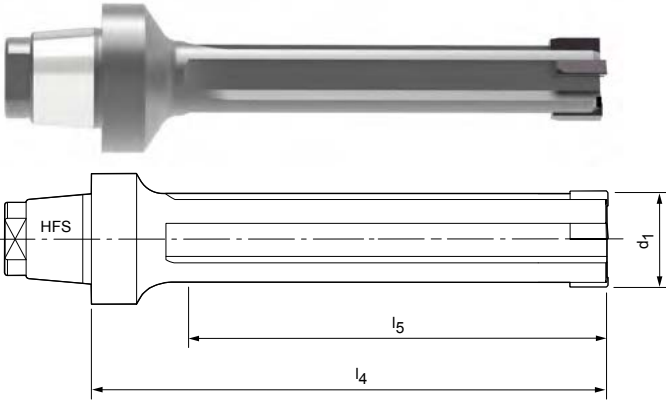

Características configurables



Tolerancia de diámetro del agujero IT7:

- Diámetro seleccionable libremente en incrementos de 0,001 mm
- Se puede pedir a partir de la tolerancia IT7

Especificación

HPR180Ø[diámetro][tolerancia]ML2G-CU134

Tolerancia de diámetro del agujero < IT7:

- Las tolerancias inferiores a IT7 pueden pedirse como diámetro de herramienta especial (para la variante G, véase la página 373)

Especificación de la variante G:

HPR180GØ[diámetro][tolerancia]ML2G-CU134

Dimensiones de la serie configurable IT7

d1	l ₄	l ₅	Tamaño HFS	z
7,000 - 14,590	60	40	12	4
14,600 - 21,290	60	40	12	6

Ejemplo de tolerancia IT7:

HPR180Ø16.350H7ML2G-CU134

Diámetro del agujero $d_1 = 16,350 \text{ H7}$

Ejemplo de variante G:

HPR180GØ16.350-3ML2G-CU134

Diámetro especial de la herramienta $d_1 = 16,350 -3 \mu\text{m}$

Medidas en mm.

Para el correspondiente portaherramientas para cabezal intercambiables HFS, véase a partir de la página 460.

Para la recomendación de valores de corte, véase al final del capítulo.

Escariador de cabezal intercambiable HPR

Ejecución fija, con ranuras rectas, para agujeros ciegos
HPR180

Ejecución:

Diámetro del escariador: 7,000 - 21,290 mm
Entrada: ML2G
Material de corte: HP421
Metal duro con recubrimiento de PVD

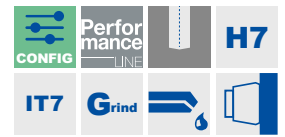
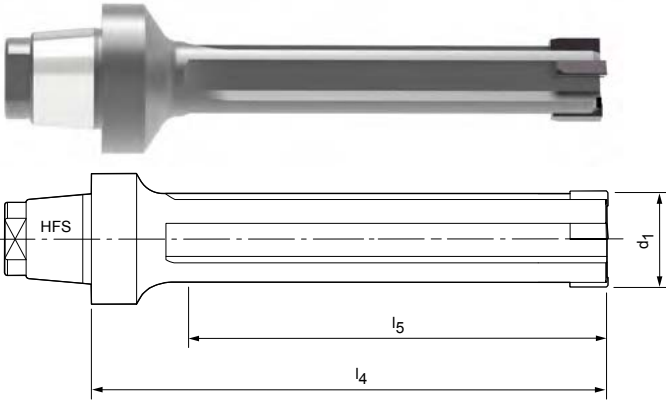

Serie preferente disponible en stock en H7

d ₁ H7	Tamaño HFS	Dimensiones			Especificación	Referencia
		l ₄	l ₅	z		
10,000	12	60	40	4	HPR180Ø10H7ML2G-HP421	30710208
12,000	12	60	40	4	HPR180Ø12H7ML2G-HP421	30710210
14,000	12	60	40	4	HPR180Ø14H7ML2G-HP421	30710212
16,000	12	60	40	6	HPR180Ø16H7ML2G-HP421	30710214
18,000	12	60	40	6	HPR180Ø18H7ML2G-HP421	30710216
19,000	12	60	40	6	HPR180Ø19H7ML2G-HP421	30710217
20,000	12	60	40	6	HPR180Ø20H7ML2G-HP421	30710218

Características configurables



Tolerancia de diámetro del agujero IT7:

- Diámetro seleccionable libremente en incrementos de 0,001 mm
- Se puede pedir a partir de la tolerancia IT7

Especificación

HPR180Ø[diámetro][tolerancia]ML2G-HP421

Tolerancia de diámetro del agujero < IT7:

- Las tolerancias inferiores a IT7 pueden pedirse como diámetro de herramienta especial (para la variante G, véase la página 373)

Especificación de la variante G:

HPR180GØ[diámetro][tolerancia]ML2G-HP421

Dimensiones de la serie configurable IT7

d ₁	l ₄	l ₅	Tamaño HFS	z
7,000 - 14,590	60	40	12	4
14,600 - 21,290	60	40	12	6

Ejemplo de tolerancia IT7:

HPR180Ø16.350H7ML2G-HP421

Diámetro del agujero d₁ = 16,350 H7

Ejemplo de variante G:

HPR180GØ16.350-5ML2G-HP421

Diámetro especial de la herramienta d₁ = 16,350 -5 µm

Medidas en mm.

Para el correspondiente portaherramientas para cabezal intercambiables HFS, véase a partir de la página 460.

Para la recomendación de valores de corte, véase al final del capítulo.

Escariador de cabezal intercambiable HPR

Ejecución fija, con ranuras rectas, para agujeros ciegos
HPR180

Ejecución:
Diámetro del escariador: 7,000 - 21,290 mm
Entrada: M02G
Material de corte: HP421
Metal duro con recubrimiento de PVD

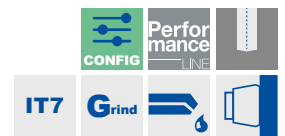
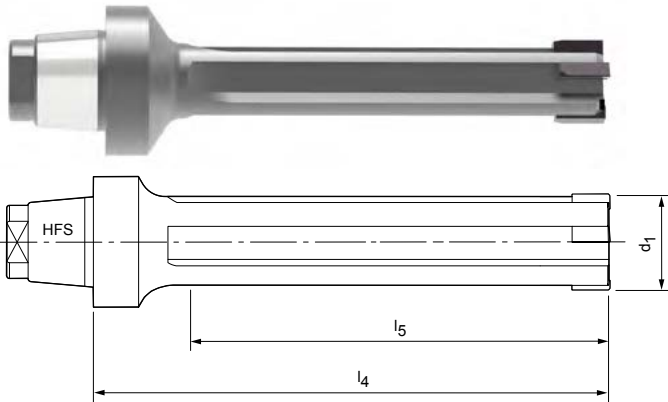

Características configurables



Tolerancia de diámetro del agujero IT7:

- Diámetro seleccionable libremente en incrementos de 0,001 mm
- Se puede pedir a partir de la tolerancia IT7

Especificación

HPR180Ø[diámetro][tolerancia]M02G-HP421

Tolerancia de diámetro del agujero < IT7:

- Las tolerancias inferiores a IT7 pueden pedirse como diámetro de herramienta especial (para la variante G, véase la página 373)

Especificación de la variante G:

HPR180GØ[diámetro][tolerancia]M02G-HP421

Dimensiones de la serie configurable IT7

d1	l4	l5	Tamaño HFS	z
7,000 - 14,590	60	40	12	4
14,600 - 21,290	60	40	12	6

Ejemplo de tolerancia IT7:

HPR180Ø16.350H7M02G-HP421

Diámetro del agujero d₁ = 16,350 H7

Ejemplo de variante G:

HPR180GØ16.350-5M02G-HP421

Diámetro especial de la herramienta d₁ = 16,350 -5 µm

Medidas en mm.

Para el correspondiente portaherramientas para cabezal intercambiables HFS, véase a partir de la página 460.

Para la recomendación de valores de corte, véase al final del capítulo.

Escariador de cabezal intercambiable HPR

Ejecución fija, con ranuras rectas, para agujeros ciegos
HPR180

Ejecución:

Diámetro del escariador: 7,000 - 21,290 mm
Entrada: MC1G
Material de corte: CP134
Cermet con recubrimiento de PVD

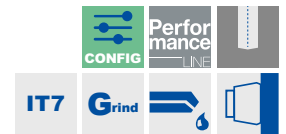
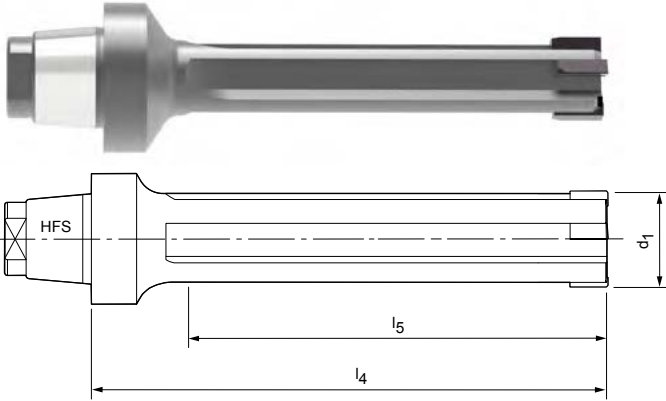

Características configurables



Tolerancia de diámetro del agujero IT7:

- Diámetro seleccionable libremente en incrementos de 0,001 mm
- Se puede pedir a partir de la tolerancia IT7

Especificación

HPR180Ø[diámetro][tolerancia]MC1G-CP134

Tolerancia de diámetro del agujero < IT7:

- Las tolerancias inferiores a IT7 pueden pedirse como diámetro de herramienta especial (para la variante G, véase la página 373)

Especificación de la variante G:

HPR180GØ[diámetro][tolerancia]MC1G-CP134

Dimensiones de la serie configurable IT7

d1	l ₄	l ₅	Tamaño HFS	z
7,000 - 14,590	60	40	12	4
14,600 - 21,290	60	40	12	6

Ejemplo de tolerancia IT7:

HPR180Ø16.350H7MC1G-CP134

Diámetro del agujero d₁ = 16,350 H7

Ejemplo de variante G:

HPR180GØ16.350-5MC1G-CP134

Diámetro especial de la herramienta d₁ = 16,350 -5 µm

Medidas en mm.

* para superficies R_a < 2 µm

Para el correspondiente portaherramientas para cabezal intercambiables HFS, véase a partir de la página 460.

Para la recomendación de valores de corte, véase al final del capítulo.

Escariador de cabezal intercambiable HPR

Ejecución fija, con ranuras rectas, para agujeros ciegos
HPR180

Ejecución:

Diámetro del escariador: 7,000 - 21,290 mm
Entrada: MC1G
Material de corte: HC419
Metal duro con recubrimiento CVD

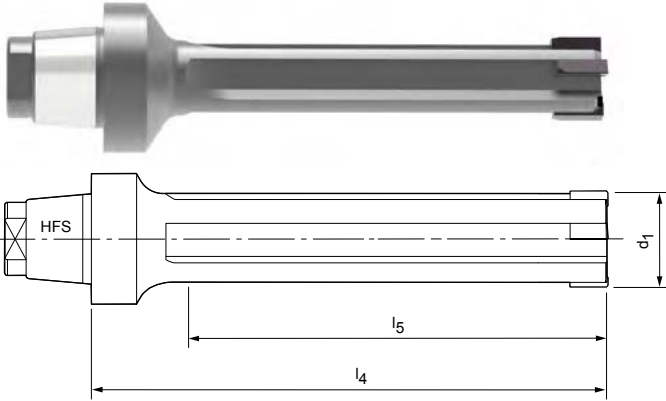

Características configurables



Tolerancia de diámetro del agujero IT7:

- Diámetro seleccionable libremente en incrementos de 0,001 mm
- Se puede pedir a partir de la tolerancia IT7

Especificación

HPR180Ø[diámetro][tolerancia]MC1G-HC419

Tolerancia de diámetro del agujero < IT7:

- Las tolerancias inferiores a IT7 pueden pedirse como diámetro de herramienta especial (para la variante G, véase la página 373)

Especificación de la variante G:

HPR180GØ[diámetro][tolerancia]MC1G-HC419

Dimensiones de la serie configurable IT7

d_1	l_4	l_5	Tamaño HFS	z
7,000 - 14,590	60	40	12	4
14,600 - 21,290	60	40	12	6

Ejemplo de tolerancia IT7:

HPR180Ø16.350H7MC1G-HC419

Diámetro del agujero $d_1 = 16,350$ H7

Ejemplo de variante G:

HPR180GØ16.350-7MC1G-HC419

Diámetro especial de la herramienta $d_1 = 16,350 - 7 \mu\text{m}$

Medidas en mm.

* para superficies $R_a < 2 \mu\text{m}$

Para el correspondiente portaherramientas para cabezal intercambiables HFS, véase a partir de la página 460.

Para la recomendación de valores de corte, véase al final del capítulo.

Escariador de cabezal intercambiable HPR

Ejecución fija, con ranuras rectas, para agujeros ciegos
HPR180

Ejecución:

Diámetro del escariador: 7,000 - 21,290 mm
Entrada: MC1G
Material de corte: HP421
Metal duro con recubrimiento de PVD

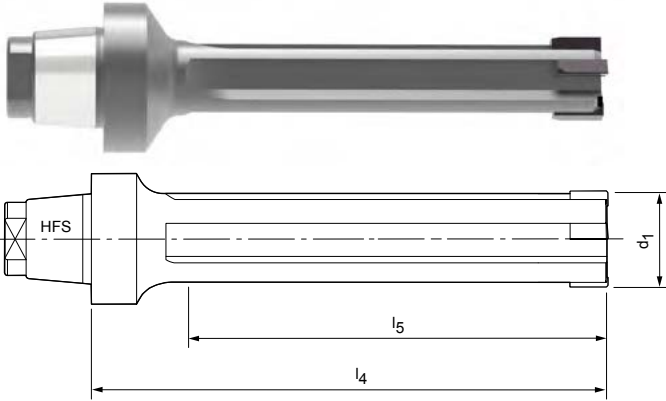

Características configurables



Tolerancia de diámetro del agujero IT7:

- Diámetro seleccionable libremente en incrementos de 0,001 mm
- Se puede pedir a partir de la tolerancia IT7

Especificación

HPR180Ø[diámetro][tolerancia]MC1G-HP421

Tolerancia de diámetro del agujero < IT7:

- Las tolerancias inferiores a IT7 pueden pedirse como diámetro de herramienta especial (para la variante G, véase la página 373)

Especificación de la variante G:

HPR180GØ[diámetro][tolerancia]MC1G-HP421

Dimensiones de la serie configurable IT7

d1	l ₄	l ₅	Tamaño HFS	z
7,000 - 14,590	60	40	12	4
14,600 - 21,290	60	40	12	6

Ejemplo de tolerancia IT7:

HPR180Ø16.350H7MC1G-HP421

Diámetro del agujero d₁ = 16,350 H7

Ejemplo de variante G:

HPR180GØ16.350-5MC1G-HP421

Diámetro especial de la herramienta d₁ = 16,350 -5 μm

Medidas en mm.

Para el correspondiente portaherramientas para cabezal intercambiables HFS, véase a partir de la página 460.

Para la recomendación de valores de corte, véase al final del capítulo.

Escariador de cabezal intercambiable HPR

Ejecución fija, con ranuras rectas, para agujeros ciegos
HPR180

Ejecución:

Diámetro del escariador: 7,000 - 21,290 mm
Entrada: MC1G
Material de corte: HP423
Metal duro con recubrimiento de PVD

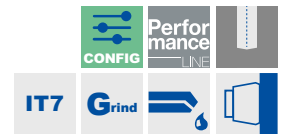
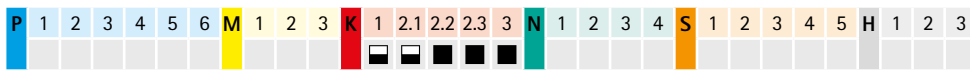
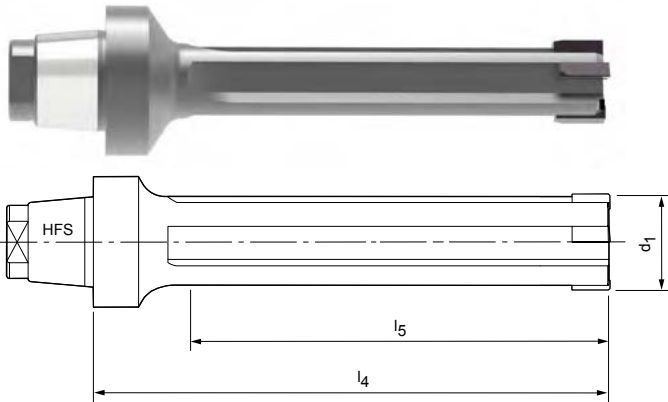

Características configurables



Tolerancia de diámetro del agujero IT7:
- Diámetro seleccionable libremente en incrementos de 0,001 mm
- Se puede pedir a partir de la tolerancia IT7

Especificación
HPR180Ø[diámetro][tolerancia]MC1G-HP423

Tolerancia de diámetro del agujero < IT7:
- Las tolerancias inferiores a IT7 pueden pedirse como diámetro de herramienta especial (para la variante G, véase la página 373)

Especificación de la variante G:
HPR180GØ[diámetro][tolerancia]MC1G-HP423

Dimensiones de la serie configurable IT7

d1	l4	l5	Tamaño HFS	z
7,000 - 14,590	60	40	12	4
14,600 - 21,290	60	40	12	6

Ejemplo de tolerancia IT7:
HPR180Ø16.350H7MC1G-HP423

Diámetro del agujero d₁ = 16,350 H7

Ejemplo de variante G:
HPR180GØ16.350-8MC1G-HP423

Diámetro especial de la herramienta d₁ = 16,350 -7 µm

Medidas en mm.
Para el correspondiente portaherramientas para cabezal intercambiables HFS, véase a partir de la página 460.
Para la recomendación de valores de corte, véase al final del capítulo.

Escariador de cabezal intercambiable HPR

Ejecución fija, con ranuras rectas, para agujeros ciegos
HPR180

Ejecución:

Diámetro del escariador: 7,000 - 21,290 mm
Entrada: MA0A
Material de corte: PU620
De PCD

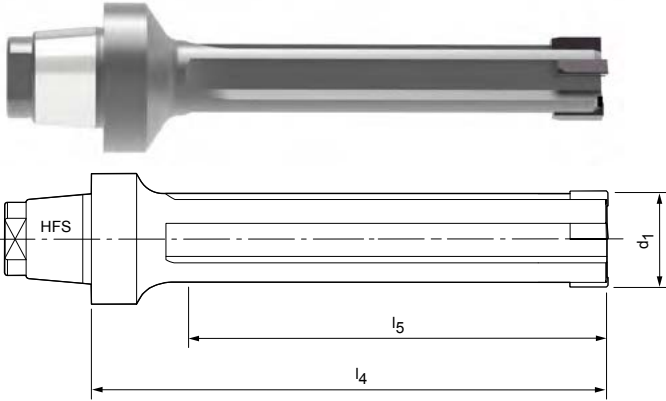

Características configurables



Tolerancia de diámetro del agujero IT7:

- Diámetro seleccionable libremente en incrementos de 0,001 mm
- Se puede pedir a partir de la tolerancia IT7

Especificación

HPR180Ø[diámetro][tolerancia]MA0A-PU620

Tolerancia de diámetro del agujero < IT7:

- Las tolerancias inferiores a IT7 pueden pedirse como diámetro de herramienta especial (para la variante G, véase la página 373)

Especificación de la variante G:

HPR180GØ[diámetro][tolerancia]MA0A-PU620

Dimensiones de la serie configurable IT7

d1	l ₄	l ₅	Tamaño HFS	z
7,000 - 14,590	60	40	12	4
14,600 - 21,290	60	40	12	6

Ejemplo de tolerancia IT7:

HPR180Ø16.350H7MA0A-PU620

Diámetro del agujero d₁ = 16,350 H7

Ejemplo de variante G:

HPR180GØ16.350-3MA0A-PU620

Diámetro especial de la herramienta d₁ = 16,350 -3 µm

Medidas en mm.

Para el correspondiente portaherramientas para cabezal intercambiables HFS, véase a partir de la página 460.

Para la recomendación de valores de corte, véase al final del capítulo.

Escariador de cabezal intercambiable HPR

Ejecución fija, con ranuras rectas, para agujeros ciegos
HPR180

Ejecución:

Diámetro del escariador: 7,000 - 21,290 mm
Entrada: M02G
Material de corte: HP625
Metal duro con recubrimiento de PVD

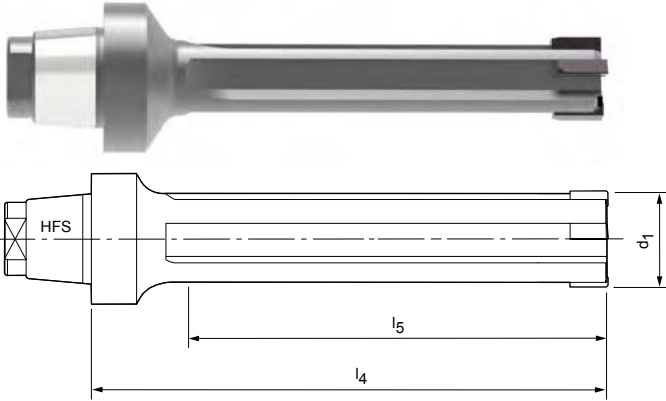

Características configurables



Tolerancia de diámetro del agujero IT7:

- Diámetro seleccionable libremente en incrementos de 0,001 mm
- Se puede pedir a partir de la tolerancia IT7

Especificación

HPR180Ø[diámetro][tolerancia]M02G-HP625

Tolerancia de diámetro del agujero < IT7:

- Las tolerancias inferiores a IT7 pueden pedirse como diámetro de herramienta especial (para la variante G, véase la página 373)

Especificación de la variante G:

HPR180GØ[diámetro][tolerancia]M02G-HP625

Dimensiones de la serie configurable IT7

d1	l ₄	l ₅	Tamaño HFS	z
7,000 - 14,590	60	40	12	4
14,600 - 21,290	60	40	12	6

Ejemplo de tolerancia IT7:

HPR180Ø16.350H7M02G-HP625

Diámetro del agujero d₁ = 16,350 H7

Ejemplo de variante G:

HPR180GØ16.350-7M02G-HP625

Diámetro especial de la herramienta d₁ = 16,350 -5 µm

Medidas en mm.

Para el correspondiente portaherramientas para cabezal intercambiables HFS, véase a partir de la página 460.

Para la recomendación de valores de corte, véase al final del capítulo.

Escariador de cabezal intercambiable HPR

Ejecución fija, con ranuras rectas, para agujeros ciegos
HPR150

Ejecución:

Diámetro del escariador: 16,600 - 65,000 mm
Entrada: ML2G
Material de corte: CU134
Cermet sin recubrimiento

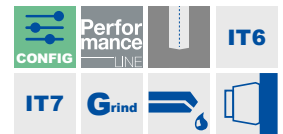
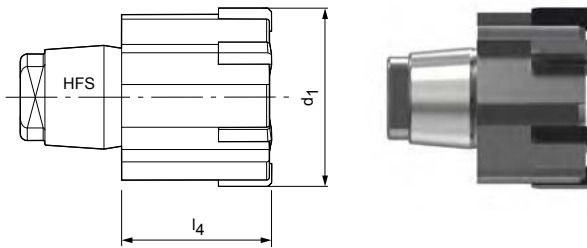

Características configurables



Tolerancia de diámetro del agujero IT6/IT7:

- Diámetro seleccionable libremente en incrementos de 0,001 mm
- En función del rango de diámetros, se puede pedir a partir de la tolerancia IT6/IT7
- > Ø30,000 IT6 | ≤ Ø30,000 IT7

Especificación

HPR150Ø[diámetro][tolerancia]ML2G-CU134

Tolerancia de diámetro del agujero < IT6/IT7:

- Las tolerancias inferiores a IT6/IT7 pueden pedirse como diámetro de herramienta especial (para la variante G, véase la página 373)

Especificación de la variante G:

HPR150GØ[diámetro][tolerancia]ML2G-CU134

Dimensiones de la serie configurable IT6/IT7

d1	l ₄	l ₅	Tamaño HFS	z	Tolerancia
16,600 - 21,290	14	-	10	6	IT7
21,300 - 24,990	15,5	-	12	6	IT7
25,000 - 28,990	15,5	-	14	6	IT7
29,000 - 29,990	17	-	16	6	IT7
30,000 - 36,990	17	-	16	6	IT6
37,000 - 44,990	17	-	20	8	IT6
45,000 - 50,700	19	-	24	8	IT6
50,710 - 65,000	25	-	24	8	IT6

Ejemplo de tolerancia IT6:

HPR150Ø37.350H6ML2G-CU134

Diámetro del agujero d₁ = 37,350 H6

Ejemplo de variante G:

HPR150GØ37.350-3ML2G-CU134

Diámetro especial de la herramienta d₁ = 37,350 -3 μm

Medidas en mm.

Para el correspondiente portaherramientas para cabezal intercambiables HFS, véase a partir de la página 460.

Para la recomendación de valores de corte, véase al final del capítulo.

Escariador de cabezal intercambiable HPR

Ejecución fija, con ranuras rectas, para agujeros ciegos
HPR150

Ejecución:

Diámetro del escariador: 16,600 - 65,000 mm
Entrada: ML2G
Material de corte: HP421
Metal duro con recubrimiento de PVD

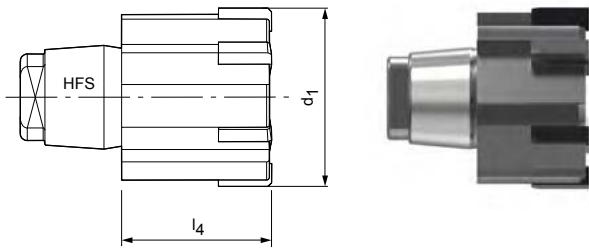

Serie preferente disponible en stock en H7

d ₁ H7	Tamaño HFS	Dimensiones		Especificación	Referencia
		l ₄	z		
22,000	12	15,5	6	HPR150Ø22H7ML2G-HP421	30098915
24,000	12	15,5	6	HPR150Ø24H7ML2G-HP421	30329443
26,000	12	15,5	6	HPR150Ø26H7ML2G-HP421	30044823
28,000	12	15,5	6	HPR150Ø28H7ML2G-HP421	30710391
30,000	16	17	6	HPR150Ø30H7ML2G-HP421	30710393
32,000	16	17	6	HPR150Ø32H7ML2G-HP421	30462441
40,000	16	17	8	HPR150Ø40H7ML2G-HP421	30586834

Características configurables

Tolerancia de diámetro del agujero IT6/IT7:

- Diámetro seleccionable libremente en incrementos de 0,001 mm
- En función del rango de diámetros, se puede pedir a partir de la tolerancia IT6/IT7
- > Ø30,000 IT6 | ≤ Ø30,000 IT7

Especificación
HPR150Ø[diámetro][tolerancia]ML2G-HP421

Tolerancia de diámetro del agujero < IT6/IT7:

- Las tolerancias inferiores a IT6/IT7 pueden pedirse como diámetro de herramienta especial (para la variante G, véase la página 373)

Especificación de la variante G:
HPR150GØ[diámetro][tolerancia]ML2G-HP421

Dimensiones de la serie configurable IT6/IT7

d ₁	l ₄	l ₅	Tamaño HFS	z	Tolerancia
16,600 - 21,290	14	-	10	6	IT7
21,300 - 24,990	15,5	-	12	6	IT7
25,000 - 28,990	15,5	-	14	6	IT7
29,000 - 29,990	17	-	16	6	IT7
30,000 - 36,990	17	-	16	6	IT6
37,000 - 44,990	17	-	20	8	IT6
45,000 - 50,700	19	-	24	8	IT6
50,710 - 65,000	25	-	24	8	IT6

Ejemplo de tolerancia IT6:
HPR150Ø37.350H6ML2G-HP421

Diámetro del agujero d₁ = 37,350 H6

Ejemplo de variante G:
HPR150GØ37.350-5ML2G-HP421

Diámetro especial de la herramienta d₁ = 37,350 -5 µm

Medidas en mm.

Para el correspondiente portaherramientas para cabezal intercambiables HFS, véase a partir de la página 460.

Para la recomendación de valores de corte, véase al final del capítulo.

Escariador de cabezal intercambiable HPR

Ejecución fija, con ranuras rectas, para agujeros ciegos
HPR150

Ejecución:

Diámetro del escariador: 16,600 - 65,000 mm
Entrada: M02G
Material de corte: HP421
Metal duro con recubrimiento de PVD

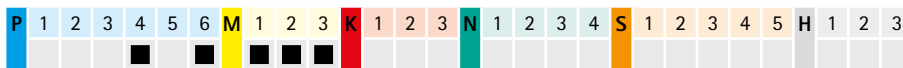
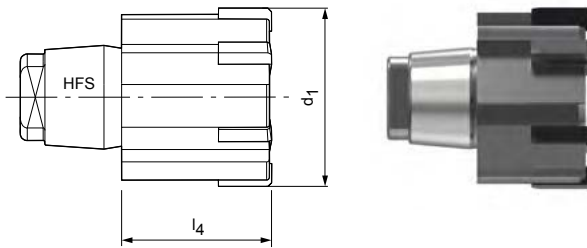

Serie preferente disponible en stock en H7

d ₁ H7	Tamaño HFS	Dimensiones		Especificación	Referencia
		l ₄	z		
20,000	10	14	6	HPR150Ø20H7M02G-HP421	30975790
26,000	14	15,5	6	HPR150Ø26H7M02G-HP421	30975773
28,000	14	15,5	6	HPR150Ø28H7M02G-HP421	30843363
30,000	16	17	6	HPR150Ø30H7M02G-HP421	30975775
32,000	16	17	6	HPR150Ø32H7M02G-HP421	30975776
35,000	16	17	6	HPR150Ø35H7M02G-HP421	30976284
40,000	20	17	8	HPR150Ø40H7M02G-HP421	30898813

Características configurables



Tolerancia de diámetro del agujero IT6/IT7:

- Diámetro seleccionable libremente en incrementos de 0,001 mm
- En función del rango de diámetros, se puede pedir a partir de la tolerancia IT6/IT7
- > Ø30,000 IT6 | ≤ Ø30,000 IT7

Especificación

HPR150Ø[diámetro][tolerancia]M02G-HP421

Tolerancia de diámetro del agujero < IT6/IT7:

- Las tolerancias inferiores a IT6/IT7 pueden pedirse como diámetro de herramienta especial (para la variante G, véase la página 373)

Especificación de la variante G:

HPR150GØ[diámetro][tolerancia]M02G-HP421

Dimensiones de la serie configurable IT6/IT7

d ₁	l ₄	l ₅	Tamaño HFS	z	Tolerancia
16,600 - 21,290	14	-	10	6	IT7
21,300 - 24,990	15,5	-	12	6	IT7
25,000 - 28,990	15,5	-	14	6	IT7
29,000 - 29,990	17	-	16	6	IT7
30,000 - 36,990	17	-	16	6	IT6
37,000 - 44,990	17	-	20	8	IT6
45,000 - 50,700	19	-	24	8	IT6
50,710 - 65,000	25	-	24	8	IT6

Ejemplo de tolerancia IT6:

HPR150Ø37.350H6M02G-HP421

Diámetro del agujero d₁ = 37,350 H6

Ejemplo de variante G:

HPR150GØ37.350-5M02G-HP421

Diámetro especial de la herramienta d₁ = 37,350 -5 μm

Medidas en mm.

Para el correspondiente portaherramientas para cabezal intercambiables HFS, véase a partir de la página 460.

Para la recomendación de valores de corte, véase al final del capítulo.

Escariador de cabezal intercambiable HPR

Ejecución fija, con ranuras rectas, para agujeros ciegos
HPR150

Ejecución:

Diámetro del escariador: 16,600 - 65,000 mm
Entrada: MC1G
Material de corte: CP134
Cermet con recubrimiento de PVD

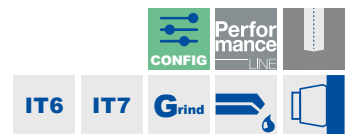
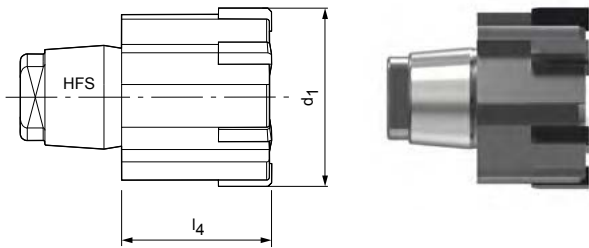

Características configurables



Tolerancia de diámetro del agujero IT6/IT7:
- Diámetro seleccionable libremente en incrementos de 0,001 mm
- En función del rango de diámetros, se puede pedir a partir de la tolerancia IT6/IT7
- > Ø30,000 IT6 | ≤ Ø30,000 IT7

Especificación
HPR150Ø[diámetro][tolerancia]MC1G-CP134

Tolerancia de diámetro del agujero < IT6/IT7:
- Las tolerancias inferiores a IT6/IT7 pueden pedirse como diámetro de herramienta especial (para la variante G, véase la página 373)

Especificación de la variante G:
HPR150GØ[diámetro][tolerancia]MC1G-CP134

Dimensiones de la serie configurable IT6/IT7

d1	l4	l5	Tamaño HFS	z	Tolerancia
16,600 - 21,290	14	-	10	6	IT7
21,300 - 24,990	15,5	-	12	6	IT7
25,000 - 28,990	15,5	-	14	6	IT7
29,000 - 29,990	17	-	16	6	IT7
30,000 - 36,990	17	-	16	6	IT6
37,000 - 44,990	17	-	20	8	IT6
45,000 - 50,700	19	-	24	8	IT6
50,710 - 65,000	25	-	24	8	IT6

Ejemplo de tolerancia IT6:
HPR150Ø37.350H6MC1G-CP134

Diámetro del agujero d₁ = 37,350 H6

Ejemplo de variante G:
HPR150GØ37.350-5MC1G-CP134

Diámetro especial de la herramienta d₁ = 37,350 -5 µm

Medidas en mm.
* para superficies R_a < 2 µm
Para el correspondiente portaherramientas para cabezal intercambiables HFS, véase a partir de la página 460.
Para la recomendación de valores de corte, véase al final del capítulo.

Escariador de cabezal intercambiable HPR

Ejecución fija, con ranuras rectas, para agujeros ciegos
HPR150

Ejecución:

Diámetro del escariador: 16,600 - 65,000 mm
Entrada: MC1G
Material de corte: HC419
Metal duro con recubrimiento CVD

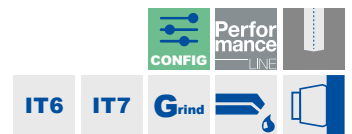
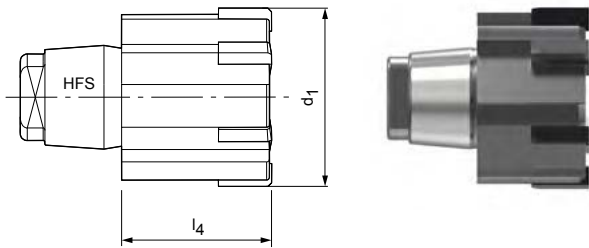

Características configurables



Tolerancia de diámetro del agujero IT6/IT7:

- Diámetro seleccionable libremente en incrementos de 0,001 mm
- En función del rango de diámetros, se puede pedir a partir de la tolerancia IT6/IT7
- > Ø30,000 IT6 | ≤ Ø30,000 IT7

Especificación

HPR150Ø[diámetro][tolerancia]MC1G-HC419

Tolerancia de diámetro del agujero < IT6/IT7:

- Las tolerancias inferiores a IT6/IT7 pueden pedirse como diámetro de herramienta especial (para la variante G, véase la página 373)

Especificación de la variante G:

HPR150GØ[diámetro][tolerancia]MC1G-HC419

Dimensiones de la serie configurable IT6/IT7

d1	l4	l5	Tamaño HFS	z	Tolerancia
16,600 - 21,290	14	-	10	6	IT7
21,300 - 24,990	15,5	-	12	6	IT7
25,000 - 28,990	15,5	-	14	6	IT7
29,000 - 29,990	17	-	16	6	IT7
30,000 - 36,990	17	-	16	6	IT6
37,000 - 44,990	17	-	20	8	IT6
45,000 - 50,700	19	-	24	8	IT6
50,710 - 65,000	25	-	24	8	IT6

Ejemplo de tolerancia IT6:

HPR150Ø37.350H6MC1G-HC419

Diámetro del agujero $d_1 = 37,350$ H6

Ejemplo de variante G:

HPR150GØ37.350-7MC1G-HC419

Diámetro especial de la herramienta $d_1 = 37,350 -7 \mu\text{m}$

Medidas en mm.

* para superficies $R_a < 2 \mu\text{m}$

Para el correspondiente portaherramientas para cabezal intercambiables HFS, véase a partir de la página 460.

Para la recomendación de valores de corte, véase al final del capítulo.

Escariador de cabezal intercambiable HPR

Ejecución fija, con ranuras rectas, para agujeros ciegos
HPR150

Ejecución:

Diámetro del escariador: 16,600 - 65,000 mm
Entrada: MC1G
Material de corte: HP421
Metal duro con recubrimiento de PVD

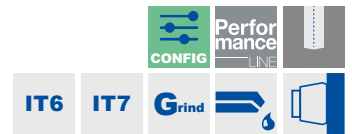
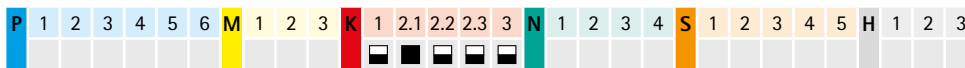
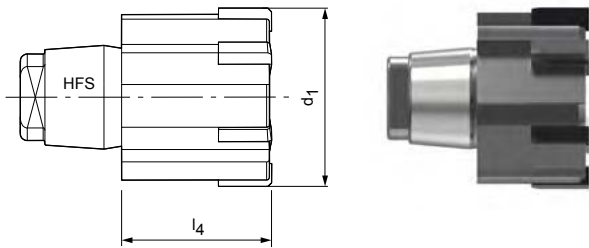

Características configurables



Tolerancia de diámetro del agujero IT6/IT7:

- Diámetro seleccionable libremente en incrementos de 0,001 mm
- En función del rango de diámetros, se puede pedir a partir de la tolerancia IT6/IT7
- > Ø30,000 IT6 | ≤ Ø30,000 IT7

Especificación

HPR150Ø[diámetro][tolerancia]MC1G-HP421

Tolerancia de diámetro del agujero < IT6/IT7:

- Las tolerancias inferiores a IT6/IT7 pueden pedirse como diámetro de herramienta especial (para la variante G, véase la página 373)

Especificación de la variante G:

HPR150GØ[diámetro][tolerancia]MC1G-HP421

Dimensiones de la serie configurable IT6/IT7

d1	l ₄	l ₅	Tamaño HFS	z	Tolerancia
16,600 - 21,290	14	-	10	6	IT7
21,300 - 24,990	15,5	-	12	6	IT7
25,000 - 28,990	15,5	-	14	6	IT7
29,000 - 29,990	17	-	16	6	IT7
30,000 - 36,990	17	-	16	6	IT6
37,000 - 44,990	17	-	20	8	IT6
45,000 - 50,700	19	-	24	8	IT6
50,710 - 65,000	25	-	24	8	IT6

Ejemplo de tolerancia IT6:

HPR150Ø37.350H6MC1G-HP421

Diámetro del agujero d₁ = 37,350 H6

Ejemplo de variante G:

HPR150GØ37.350-5MC1G-HP421

Diámetro especial de la herramienta d₁ = 37,350 -5 μm

Medidas en mm.

Para el correspondiente portaherramientas para cabezal intercambiables HFS, véase a partir de la página 460.

Para la recomendación de valores de corte, véase al final del capítulo.

Escariador de cabezal intercambiable HPR

Ejecución fija, con ranuras rectas, para agujeros ciegos
HPR150

Ejecución:
Diámetro del escariador: 16,600 - 65,000 mm
Entrada: MC1G
Material de corte: HP423
Metal duro con recubrimiento de PVD

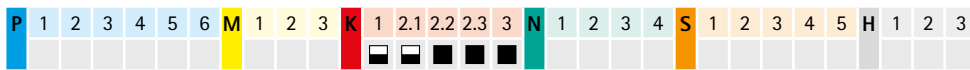
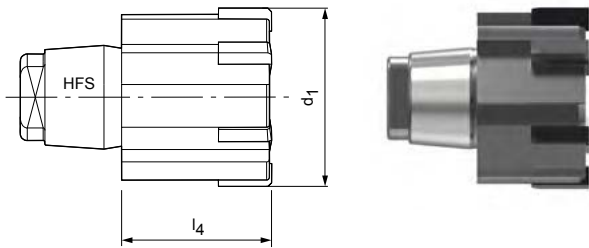

Características configurables



Tolerancia de diámetro del agujero IT6/IT7:
- Diámetro seleccionable libremente en incrementos de 0,001 mm
- En función del rango de diámetros, se puede pedir a partir de la tolerancia IT6/IT7
- > Ø30,000 IT6 | ≤ Ø30,000 IT7

Especificación
HPR150Ø[diámetro][tolerancia]MC1G-HP423

Tolerancia de diámetro del agujero < IT6/IT7:
- Las tolerancias inferiores a IT6/IT7 pueden pedirse como diámetro de herramienta especial (para la variante G, véase la página 373)

Especificación de la variante G:
HPR150GØ[diámetro][tolerancia]MC1G-HP423

Dimensiones de la serie configurable IT6/IT7

d1	l4	l5	Tamaño HFS	z	Tolerancia
16,600 - 21,290	14	-	10	6	IT7
21,300 - 24,990	15,5	-	12	6	IT7
25,000 - 28,990	15,5	-	14	6	IT7
29,000 - 29,990	17	-	16	6	IT7
30,000 - 36,990	17	-	16	6	IT6
37,000 - 44,990	17	-	20	8	IT6
45,000 - 50,700	19	-	24	8	IT6
50,710 - 65,000	25	-	24	8	IT6

Ejemplo de tolerancia IT6:
HPR150Ø37.350H6MC1G-HP423

Diámetro del agujero d₁ = 37,350 H6

Ejemplo de variante G:
HPR150GØ37.350-8MC1G-HP423

Diámetro especial de la herramienta d₁ = 37,350 -7 µm

Medidas en mm.
Para el correspondiente portaherramientas para cabezal intercambiables HFS, véase a partir de la página 460.
Para la recomendación de valores de corte, véase al final del capítulo.

Escariador de cabezal intercambiable HPR

Ejecución fija, con ranuras rectas, para agujeros ciegos
HPR150

Ejecución:

Diámetro del escariador: 16,600 - 65,000 mm
Entrada: MA0A
Material de corte: PU620
De PCD

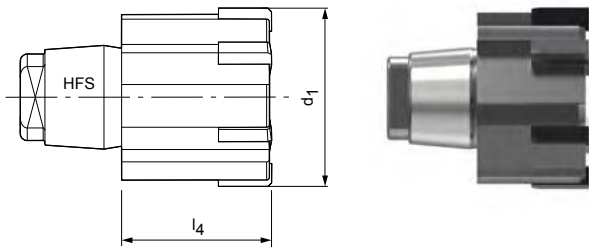

Características configurables



Tolerancia de diámetro del agujero IT6/IT7:

- Diámetro seleccionable libremente en incrementos de 0,001 mm
- En función del rango de diámetros, se puede pedir a partir de la tolerancia IT6/IT7
- > Ø30,000 IT6 | ≤ Ø30,000 IT7

Especificación

HPR150Ø[diámetro][tolerancia]MA0A-PU620

Tolerancia de diámetro del agujero < IT6/IT7:

- Las tolerancias inferiores a IT6/IT7 pueden pedirse como diámetro de herramienta especial (para la variante G, véase la página 373)

Especificación de la variante G:

HPR150GØ[diámetro][tolerancia]MA0A-PU620

Dimensiones de la serie configurable IT6/IT7

d1	l ₄	l ₅	Tamaño HFS	z	Tolerancia
16,600 - 21,290	14	-	10	6	IT7
21,300 - 24,990	15,5	-	12	6	IT7
25,000 - 28,990	15,5	-	14	6	IT7
29,000 - 29,990	17	-	16	6	IT7
30,000 - 36,990	17	-	16	6	IT6
37,000 - 44,990	17	-	20	8	IT6
45,000 - 50,700	19	-	24	8	IT6
50,710 - 65,000	25	-	24	8	IT6

Ejemplo de tolerancia IT6:

HPR150Ø37.350H6MA0A-PU620

Diámetro del agujero d₁ = 37,350 H6

Ejemplo de variante G:

HPR150GØ37.350-3MA0A-PU620

Diámetro especial de la herramienta d₁ = 37,350 -3 μm

Medidas en mm.

Para el correspondiente portaherramientas para cabezal intercambiables HFS, véase a partir de la página 460.

Para la recomendación de valores de corte, véase al final del capítulo.

Escariador de cabezal intercambiable HPR

Ejecución fija, con ranuras rectas, para agujeros ciegos
HPR150

Ejecución:

Diámetro del escariador: 16,600 - 65,000 mm
Entrada: M02G
Material de corte: HP625
Metal duro con recubrimiento de PVD

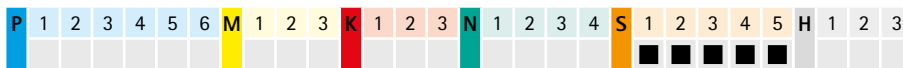
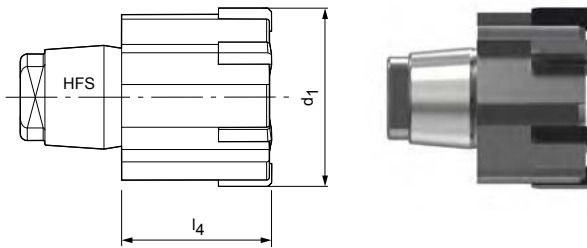

Características configurables



Tolerancia de diámetro del agujero IT6/IT7:

- Diámetro seleccionable libremente en incrementos de 0,001 mm
- En función del rango de diámetros, se puede pedir a partir de la tolerancia IT6/IT7
- > Ø30,000 IT6 | ≤ Ø30,000 IT7

Especificación

HPR150Ø[diámetro][tolerancia]M02G-HP625

Tolerancia de diámetro del agujero < IT6/IT7:

- Las tolerancias inferiores a IT6/IT7 pueden pedirse como diámetro de herramienta especial (para la variante G, véase la página 373)

Especificación de la variante G:

HPR150GØ[diámetro][tolerancia]M02G-HP625

Dimensiones de la serie configurable IT6/IT7

d1	l ₄	l ₅	Tamaño HFS	z	Tolerancia
16,600 - 21,290	14	-	10	6	IT7
21,300 - 24,990	15,5	-	12	6	IT7
25,000 - 28,990	15,5	-	14	6	IT7
29,000 - 29,990	17	-	16	6	IT7
30,000 - 36,990	17	-	16	6	IT6
37,000 - 44,990	17	-	20	8	IT6
45,000 - 50,700	19	-	24	8	IT6
50,710 - 65,000	25	-	24	8	IT6

Ejemplo de tolerancia IT6:

HPR150Ø37.350H6M02G-HP625

Diámetro del agujero d₁ = 37,350 H6

Ejemplo de variante G:

HPR150GØ37.350-7M02G-HP625

Diámetro especial de la herramienta d₁ = 37,350 -5 μm

Medidas en mm.

Para el correspondiente portaherramientas para cabezal intercambiables HFS, véase a partir de la página 460.

Para la recomendación de valores de corte, véase al final del capítulo.

Escariador de cabezal intercambiable HPR

Ejecución de ajuste de precisión, con ranuras rectas, para agujero pasante HPR230

Ejecución:

Diámetro del escariador: 7,000 - 18,590 mm
 Entrada: MC1G
 Material de corte: CP134
 Cermet con recubrimiento de PVD

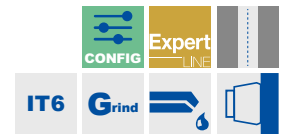
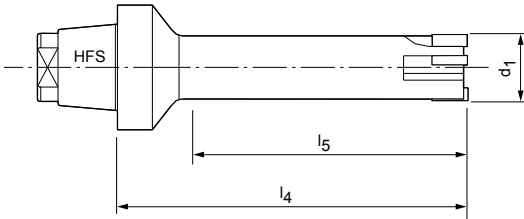

Características configurables



Tolerancia de diámetro del agujero IT6:

- Diámetro seleccionable libremente en incrementos de 0,001 mm
- Se puede pedir en tolerancia IT6

Especificación

HPR230Ø[diámetro][tolerancia]MC1G-CP134

Tolerancia del diámetro del agujero < IT6:

- Las tolerancias inferiores a IT6 pueden pedirse como diámetro de herramienta especial (para la variante G, véase la página 373)

Especificación de la variante G:

HPR230GØ[diámetro][tolerancia]MC1G-CP134

Dimensiones de la serie configurable IT6

d_1	l_4	l_5	Tamaño HFS	z
7,000 - 9,590	60	45	12	4
9,600 - 18,590	60	45	12	6

Ejemplo de tolerancia IT6:

HPR230Ø10.350H6MC1G-CP134

Diámetro del agujero $d_1 = 10,350 \text{ H6}$

Ejemplo de variante G:

HPR230GØ10.350+1-1MC1G-CP134

Diámetro especial de la herramienta $d_1 = 10,350 +1 \mu\text{m}$
 $-1 \mu\text{m}$

Medidas en mm.

* para superficies $R_a < 2 \mu\text{m}$

Para el correspondiente portaherramientas para cabezal intercambiables HFS, véase a partir de la página 460.

Para la recomendación de valores de corte, véase al final del capítulo.

Escariador de cabezal intercambiable HPR

Ejecución de ajuste de precisión, con ranuras rectas, para agujero pasante
HPR230

Ejecución:

Diámetro del escariador: 7,000 - 18,590 mm
Entrada: MC1G
Material de corte: HP421
Metal duro con recubrimiento de PVD

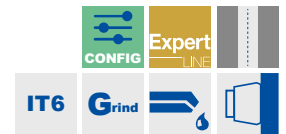
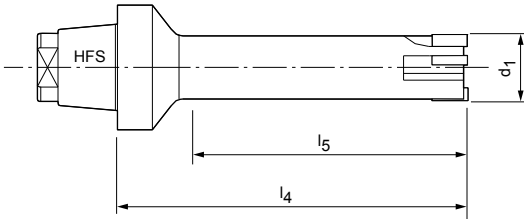

Características configurables



Tolerancia de diámetro del agujero IT6:

- Diámetro seleccionable libremente en incrementos de 0,001 mm
- Se puede pedir en tolerancia IT6

Especificación

HPR230Ø[diámetro][tolerancia]MC1G-HP421

Tolerancia del diámetro del agujero < IT6:

- Las tolerancias inferiores a IT6 pueden pedirse como diámetro de herramienta especial (para la variante G, véase la página 373)

Especificación de la variante G:

HPR230GØ[diámetro][tolerancia]MC1G-HP421

Dimensiones de la serie configurable IT6

d_1	l_4	l_5	Tamaño HFS	z
7,000 - 9,590	60	45	12	4
9,600 - 18,590	60	45	12	6

Ejemplo de tolerancia IT6:

HPR230Ø10.350H6MC1G-HP421

Diámetro del agujero $d_1 = 10,350 \text{ H6}$

Ejemplo de variante G:

HPR230GØ10.350+1-1MC1G-HP421

Diámetro especial de la herramienta $d_1 = 10,350 +1 \mu\text{m} -1 \mu\text{m}$

Medidas en mm.

Para el correspondiente portaherramientas para cabezal intercambiables HFS, véase a partir de la página 460.

Para la recomendación de valores de corte, véase al final del capítulo.

Escariador de cabezal intercambiable HPR

Ejecución de ajuste de precisión, con ranuras rectas, para agujero pasante HPR230

Ejecución:

Diámetro del escariador: 7,000 - 18,590 mm
 Entrada: MC1G
 Material de corte: HP423
 Metal duro con recubrimiento de PVD

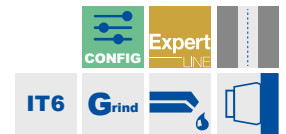
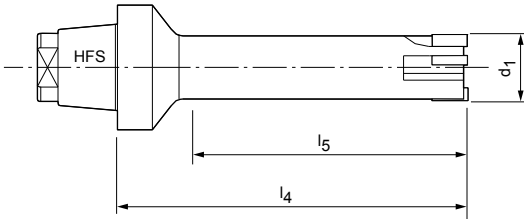

Características configurables



Tolerancia de diámetro del agujero IT6:
 - Diámetro seleccionable libremente en incrementos de 0,001 mm
 - Se puede pedir en tolerancia IT6

Especificación
 HPR230Ø[diámetro][tolerancia]MC1G-HP423

Tolerancia del diámetro del agujero < IT6:
 - Las tolerancias inferiores a IT6 pueden pedirse como diámetro de herramienta especial (para la variante G, véase la página 373)

Especificación de la variante G:
 HPR230GØ[diámetro][tolerancia]MC1G-HP423

Dimensiones de la serie configurable IT6

d ₁	l ₄	l ₅	Tamaño HFS	z
7,000 - 9,590	60	45	12	4
9,600 - 18,590	60	45	12	6

Ejemplo de tolerancia IT6:
 HPR230Ø10.350H6MC1G-HP423

Diámetro del agujero d₁ = 10,350 H6

Ejemplo de variante G:
 HPR230GØ10.350+1-1MC1G-HP423

Diámetro especial de la herramienta d₁ = 10,350 +1 µm
 -1 µm

Medidas en mm.
 Para el correspondiente portaherramientas para cabezal intercambiables HFS, véase a partir de la página 460.
 Para la recomendación de valores de corte, véase al final del capítulo.

Escariador de cabezal intercambiable HPR

Ejecución de ajuste de precisión, con ranuras rectas, para agujero pasante
HPR230

Ejecución:

Diámetro del escariador: 7,000 - 18,590 mm
Entrada: MA0A
Material de corte: PU620
De PCD

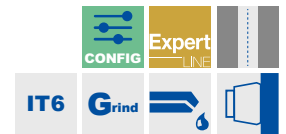
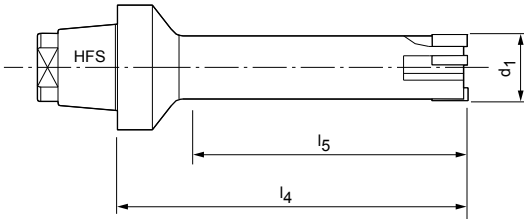

Características configurables



Tolerancia de diámetro del agujero IT6:

- Diámetro seleccionable libremente en incrementos de 0,001 mm
- Se puede pedir en tolerancia IT6

Especificación

HPR230Ø[diámetro][tolerancia]MA0A-PU620

Tolerancia del diámetro del agujero < IT6:

- Las tolerancias inferiores a IT6 pueden pedirse como diámetro de herramienta especial (para la variante G, véase la página 373)

Especificación de la variante G:

HPR230GØ[diámetro][tolerancia]MA0A-PU620

Dimensiones de la serie configurable IT6

d_1	l_4	l_5	Tamaño HFS	z
7,000 - 9,590	60	45	12	4
9,600 - 18,590	60	45	12	6

Ejemplo de tolerancia IT6:

HPR230Ø10.350H6MA0A-PU620

Diámetro del agujero $d_1 = 10,350 \text{ H6}$

Ejemplo de variante G:

HPR230GØ10.350+1-1MA0A-PU620

Diámetro especial de la herramienta $d_1 = 10,350 +1 \mu\text{m}$
-1 μm

Medidas en mm.

Para el correspondiente portaherramientas para cabezal intercambiables HFS, véase a partir de la página 460.

Para la recomendación de valores de corte, véase al final del capítulo.

Escariador de cabezal intercambiable HPR

Ejecución de ajuste de precisión, con ranuras oblicuas a la izquierda, para agujeros pasantes HPR231

Ejecución:

Diámetro del escariador: 7,000 - 18,590 mm
 Entrada: ME1G
 Material de corte: CU134
 Cermet sin recubrimiento

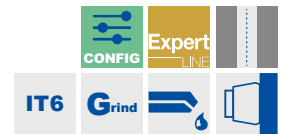
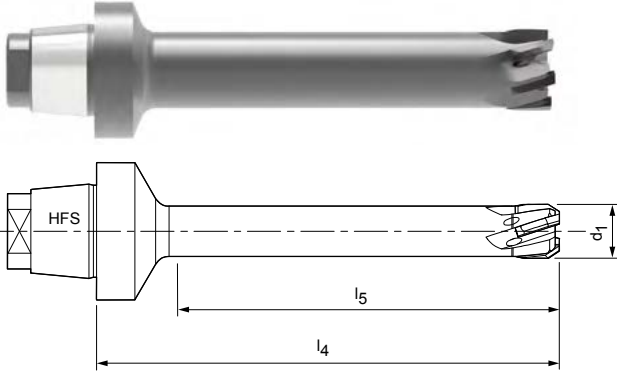

Características configurables



Tolerancia de diámetro del agujero IT6:

- Diámetro seleccionable libremente en incrementos de 0,001 mm
- Se puede pedir en tolerancia IT6

Especificación

HPR231Ø[diámetro][tolerancia]ME1G-CU134

Tolerancia del diámetro del agujero < IT6:

- Las tolerancias inferiores a IT6 pueden pedirse como diámetro de herramienta especial (para la variante G, véase la página 373)

Especificación de la variante G:

HPR231GØ[diámetro][tolerancia]ME1G-CU134

Dimensiones de la serie configurable IT6

d ₁	l ₄	l ₅	Tamaño HFS	z
7,000 - 9,590	60	45	12	4
9,600 - 18,590	60	45	12	6

Ejemplo de tolerancia IT6:

HPR231Ø10.350H6ME1G-CU134

Diámetro del agujero d₁ = 10,350 H6

Ejemplo de variante G:

HPR231GØ10.350+1-1ME1G-CU134

Diámetro especial de la herramienta d₁ = 10,350 +1 μm
 -1 μm

Medidas en mm.

Para el correspondiente portaherramientas para cabezal intercambiables HFS, véase a partir de la página 460.

Para la recomendación de valores de corte, véase al final del capítulo.

Escariador de cabezal intercambiable HPR

Ejecución de ajuste de precisión, con ranuras oblicuas a la izquierda, para agujeros pasantes HPR231

Ejecución:

Diámetro del escariador: 7,000 - 18,590 mm
 Entrada: ME1G
 Material de corte: HP421
 Metal duro con recubrimiento de PVD

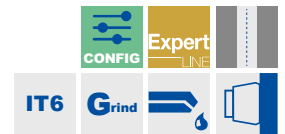
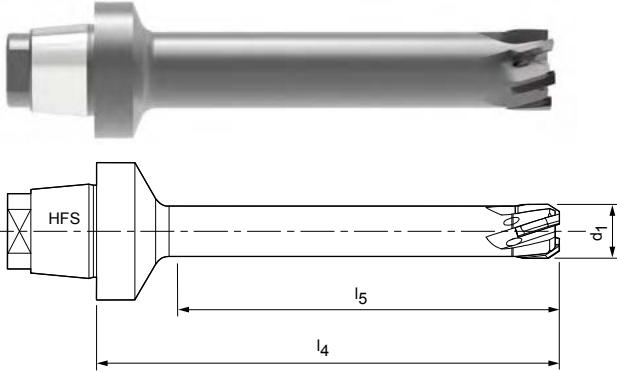

Características configurables



Tolerancia de diámetro del agujero IT6:

- Diámetro seleccionable libremente en incrementos de 0,001 mm
- Se puede pedir en tolerancia IT6

Especificación

HPR231Ø[diámetro][tolerancia]ME1G-HP421

Tolerancia del diámetro del agujero < IT6:

- Las tolerancias inferiores a IT6 pueden pedirse como diámetro de herramienta especial (para la variante G, véase la página 373)

Especificación de la variante G:

HPR231GØ[diámetro][tolerancia]ME1G-HP421

Dimensiones de la serie configurable IT6

d_1	l_4	l_5	Tamaño HFS	z
7,000 - 9,590	60	45	12	4
9,600 - 18,590	60	45	12	6

Ejemplo de tolerancia IT6:

HPR231Ø10.350H6ME1G-HP421

Diámetro del agujero $d_1 = 10,350 \text{ H6}$

Ejemplo de variante G:

HPR231GØ10.350+1-1ME1G-HP421

Diámetro especial de la herramienta $d_1 = 10,350 +1 \mu\text{m} -1 \mu\text{m}$

Medidas en mm.

Para el correspondiente portaherramientas para cabezal intercambiables HFS, véase a partir de la página 460.

Para la recomendación de valores de corte, véase al final del capítulo.

Escariador de cabezal intercambiable HPR

Ejecución de ajuste de precisión, con ranuras oblicuas a la izquierda, para agujeros pasantes HPR231

Ejecución:

Diámetro del escariador: 7,000 - 18,590 mm
 Entrada: MF1G
 Material de corte: HP421
 Metal duro con recubrimiento de PVD

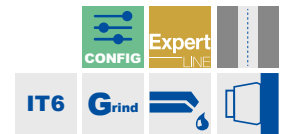
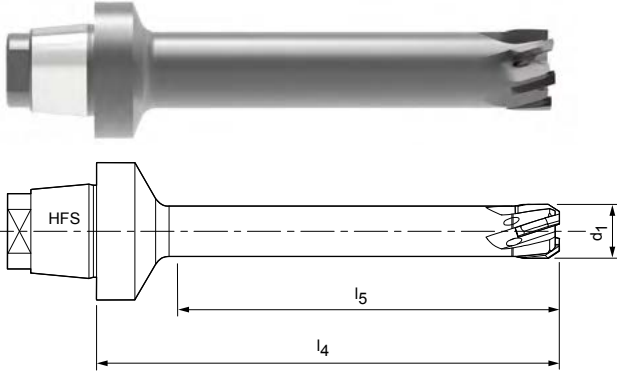

Características configurables



Tolerancia de diámetro del agujero IT6:

- Diámetro seleccionable libremente en incrementos de 0,001 mm
- Se puede pedir en tolerancia IT6

Especificación

HPR231Ø[diámetro][tolerancia]MF1G-HP421

Tolerancia del diámetro del agujero < IT6:

- Las tolerancias inferiores a IT6 pueden pedirse como diámetro de herramienta especial (para la variante G, véase la página 373)

Especificación de la variante G:

HPR231GØ[diámetro][tolerancia]MF1G-HP421

Dimensiones de la serie configurable IT6

d_1	l_4	l_5	Tamaño HFS	z
7,000 - 9,590	60	45	12	4
9,600 - 18,590	60	45	12	6

Ejemplo de tolerancia IT6:

HPR231Ø10.350H6MF1G-HP421

Diámetro del agujero $d_1 = 10,350 \text{ H6}$

Ejemplo de variante G:

HPR231GØ10.350+1-1MF1G-HP421

Diámetro especial de la herramienta $d_1 = 10,350 +1 \mu\text{m}$
 $-1 \mu\text{m}$

Medidas en mm.

Para el correspondiente portaherramientas para cabezal intercambiables HFS, véase a partir de la página 460.

Para la recomendación de valores de corte, véase al final del capítulo.

Escariador de cabezal intercambiable HPR

Ejecución de ajuste de precisión, con ranuras oblicuas a la izquierda, para agujeros pasantes HPR231

Ejecución:

Diámetro del escariador: 7,000 - 18,590 mm
 Entrada: MF1G
 Material de corte: HP625
 Metal duro con recubrimiento de PVD

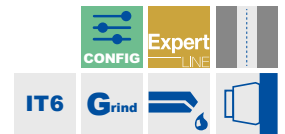
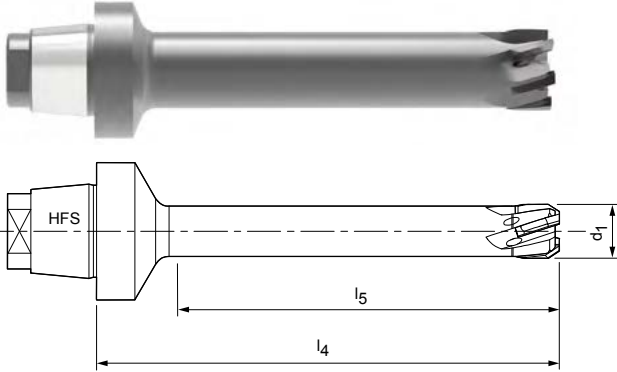

Características configurables



Tolerancia de diámetro del agujero IT6:

- Diámetro seleccionable libremente en incrementos de 0,001 mm
- Se puede pedir en tolerancia IT6

Especificación

HPR231Ø[diámetro][tolerancia]MF1G-HP625

Tolerancia del diámetro del agujero < IT6:

- Las tolerancias inferiores a IT6 pueden pedirse como diámetro de herramienta especial (para la variante G, véase la página 373)

Especificación de la variante G:

HPR231GØ[diámetro][tolerancia]MF1G-HP625

Dimensiones de la serie configurable IT6

d_1	l_4	l_5	Tamaño HFS	z
7,000 - 9,590	60	45	12	4
9,600 - 18,590	60	45	12	6

Ejemplo de tolerancia IT6:

HPR231Ø10.350H6MF1G-HP625

Diámetro del agujero $d_1 = 10,350 \text{ H6}$

Ejemplo de variante G:

HPR231GØ10.350+1-1MF1G-HP625

Diámetro especial de la herramienta $d_1 = 10,350 +1 \mu\text{m} -1 \mu\text{m}$

Medidas en mm.

Para el correspondiente portaherramientas para cabezal intercambiables HFS, véase a partir de la página 460.

Para la recomendación de valores de corte, véase al final del capítulo.

Escariador de cabezal intercambiable HPR

Ejecución de ajuste de precisión, con ranuras rectas, para agujero pasante HPR200

Ejecución:

Diámetro del escariador: 18,600 - 65,000 mm
 Entrada: MC1G
 Material de corte: CP134
 Cermet con recubrimiento de PVD

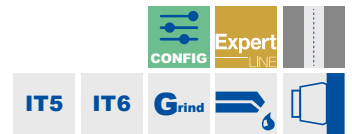
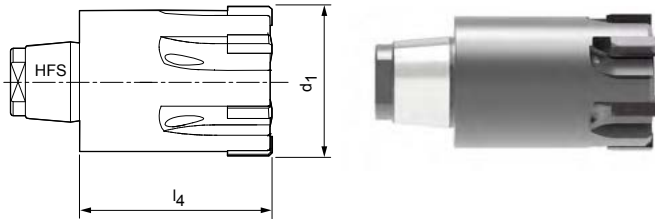

Características configurables



Tolerancia de diámetro del agujero IT5/IT6:

- Diámetro seleccionable libremente en incrementos de 0,001 mm
- En función del rango de diámetros, se puede pedir a partir de la tolerancia IT5/IT6
- > 030,000 IT5 | ≤ 030,000 IT6

Especificación

HPR200Ø[diámetro][tolerancia]MC1G-CP134

Tolerancia de diámetro del agujero < IT5/IT6:

- Las tolerancias inferiores a IT5/IT6 pueden pedirse como diámetro de herramienta especial (para la variante G, véase la página 373)

Especificación de la variante G:

HPR200GØ[diámetro][tolerancia]MC1G-CP134

Dimensiones de la serie configurable IT5/IT6

d_1	l_4	l_5	Tamaño HFS	z	Tolerancia
18,600 - 20,390	25	-	12	6	IT6
20,400 - 21,290	27	-	12	6	IT6
21,300 - 23,990	27	-	14	6	IT6
24,000 - 29,990	35	-	16	6	IT6
30,000 - 39,990	41	-	20	8	IT5
40,000 - 65,000	47	-	24	8	IT5

Ejemplo de tolerancia IT5:

HPR200Ø35.350H5MC1G-CP134

Diámetro del agujero $d_1 = 35,350$ H5

Ejemplo de variante G:

HPR200GØ35.350+1-1MC1G-CP134

Diámetro especial de la herramienta $d_1 = 35,350 +1 \mu\text{m} -1 \mu\text{m}$

Medidas en mm.

* para superficies $R_a < 2 \mu\text{m}$

Para el correspondiente portaherramientas para cabezal intercambiables HFS, véase a partir de la página 460.

Para la recomendación de valores de corte, véase al final del capítulo.

Escariador de cabezal intercambiable HPR

Ejecución de ajuste de precisión, con ranuras rectas, para agujero pasante HPR200

Ejecución:

Diámetro del escariador: 18,600 - 65,000 mm
 Entrada: MC1G
 Material de corte: HP421
 Metal duro con recubrimiento de PVD

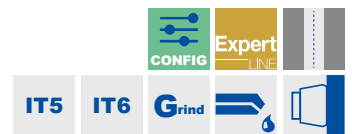
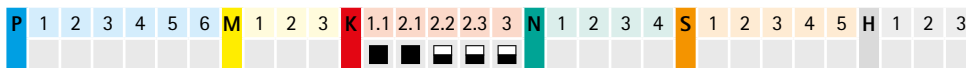
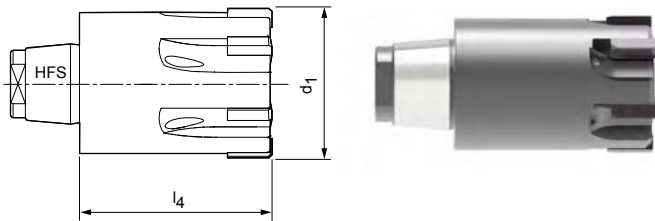

Características configurables



Tolerancia de diámetro del agujero IT5/IT6:
 - Diámetro seleccionable libremente en incrementos de 0,001 mm
 - En función del rango de diámetros, se puede pedir a partir de la tolerancia IT5/IT6
 - > 030,000 IT5 | ≤ 030,000 IT6

Especificación
 HPR200Ø[diámetro][tolerancia]MC1G-HP421

Tolerancia de diámetro del agujero < IT5/IT6:
 - Las tolerancias inferiores a IT5/IT6 pueden pedirse como diámetro de herramienta especial (para la variante G, véase la página 373)

Especificación de la variante G:
 HPR200GØ[diámetro][tolerancia]MC1G-HP421

Dimensiones de la serie configurable IT5/IT6

d ₁	l ₄	l ₅	Tamaño HFS	z	Tolerancia
18,600 - 20,390	25	-	12	6	IT6
20,400 - 21,290	27	-	12	6	IT6
21,300 - 23,990	27	-	14	6	IT6
24,000 - 29,990	35	-	16	6	IT6
30,000 - 39,990	41	-	20	8	IT5
40,000 - 65,000	47	-	24	8	IT5

Ejemplo de tolerancia IT5:
 HPR200Ø35.350H5MC1G-HP421

Diámetro del agujero d₁ = 35,350 H5

Ejemplo de variante G:
 HPR200GØ35.350+1-1MC1G-HP421

Diámetro especial de la herramienta d₁ = 35,350 +1 µm -1 µm

Medidas en mm.
 Para el correspondiente portaherramientas para cabezal intercambiables HFS, véase a partir de la página 460.
 Para la recomendación de valores de corte, véase al final del capítulo.

Escariador de cabezal intercambiable HPR

Ejecución de ajuste de precisión, con ranuras rectas, para agujero pasante
HPR200

Ejecución:

Diámetro del escariador: 18,600 - 65,000 mm
Entrada: MC1G
Material de corte: HP423
Metal duro con recubrimiento de PVD

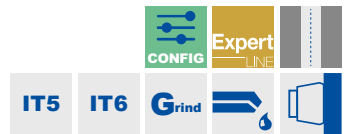
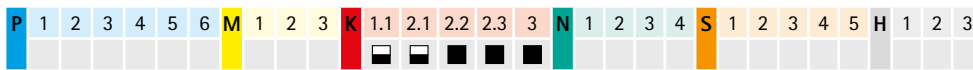
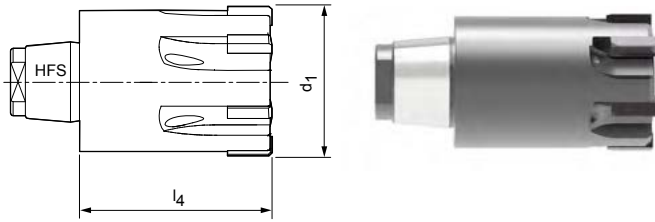

Características configurables



Tolerancia de diámetro del agujero IT5/IT6:

- Diámetro seleccionable libremente en incrementos de 0,001 mm
- En función del rango de diámetros, se puede pedir a partir de la tolerancia IT5/IT6
- > 030,000 IT5 | ≤ 030,000 IT6

Especificación

HPR200Ø[diámetro][tolerancia]MC1G-HP423

Tolerancia de diámetro del agujero < IT5/IT6:

- Las tolerancias inferiores a IT5/IT6 pueden pedirse como diámetro de herramienta especial (para la variante G, véase la página 373)

Especificación de la variante G:

HPR200GØ[diámetro][tolerancia]MC1G-HP423

Dimensiones de la serie configurable IT5/IT6

d_1	l_4	l_5	Tamaño HFS	z	Tolerancia
18,600 - 20,390	25	-	12	6	IT6
20,400 - 21,290	27	-	12	6	IT6
21,300 - 23,990	27	-	14	6	IT6
24,000 - 29,990	35	-	16	6	IT6
30,000 - 39,990	41	-	20	8	IT5
40,000 - 65,000	47	-	24	8	IT5

Ejemplo de tolerancia IT5:

HPR200Ø35.350H5MC1G-HP423

Diámetro del agujero $d_1 = 35,350$ H5

Ejemplo de variante G:

HPR200GØ35.350+1-1MC1G-HP423

Diámetro especial de la herramienta $d_1 = 35,350 +1 \mu\text{m} -1 \mu\text{m}$

Medidas en mm.

Para el correspondiente portaherramientas para cabezal intercambiables HFS, véase a partir de la página 460.

Para la recomendación de valores de corte, véase al final del capítulo.

Escariador de cabezal intercambiable HPR

Ejecución de ajuste de precisión, con ranuras rectas, para agujero pasante
HPR200

Ejecución:

Diámetro del escariador: 18,600 - 65,000 mm
Entrada: MA0A
Material de corte: PU620
De PCD

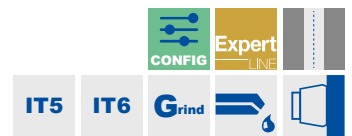
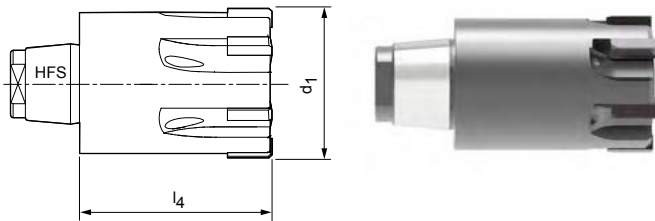

Características configurables



Tolerancia de diámetro del agujero IT5/IT6:

- Diámetro seleccionable libremente en incrementos de 0,001 mm
- En función del rango de diámetros, se puede pedir a partir de la tolerancia IT5/IT6
- > 030,000 IT5 | ≤ 030,000 IT6

Especificación

HPR200Ø[diámetro][tolerancia]MA0A-PU620

Tolerancia de diámetro del agujero < IT5/IT6:

- Las tolerancias inferiores a IT5/IT6 pueden pedirse como diámetro de herramienta especial (para la variante G, véase la página 373)

Especificación de la variante G:

HPR200GØ[diámetro][tolerancia]MA0A-PU620

Dimensiones de la serie configurable IT5/IT6

d_1	l_4	l_5	Tamaño HFS	z	Tolerancia
18,600 - 20,390	25	-	12	6	IT6
20,400 - 21,290	27	-	12	6	IT6
21,300 - 23,990	27	-	14	6	IT6
24,000 - 29,990	35	-	16	6	IT6
30,000 - 39,990	41	-	20	8	IT5
40,000 - 65,000	47	-	24	8	IT5

Ejemplo de tolerancia IT5:

HPR200Ø35.350H5MA0A-PU620

Diámetro del agujero $d_1 = 35,350$ H5

Ejemplo de variante G:

HPR200GØ35.350+1-1MA0A-PU620

Diámetro especial de la herramienta $d_1 = 35,350 +1 \mu\text{m}$
-1 μm

Medidas en mm.

Para el correspondiente portaherramientas para cabezal intercambiables HFS, véase a partir de la página 460.

Para la recomendación de valores de corte, véase al final del capítulo.

Escariador de cabezal intercambiable HPR

Ejecución de ajuste de precisión, con ranuras oblicuas a la izquierda, para agujero pasante HPR210

Ejecución:

Diámetro del escariador: 18,600 - 65,000 mm
 Entrada: ME1G
 Material de corte: CU134
 Cermet sin recubrimiento

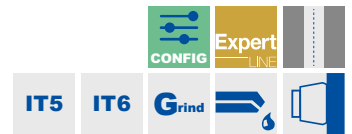
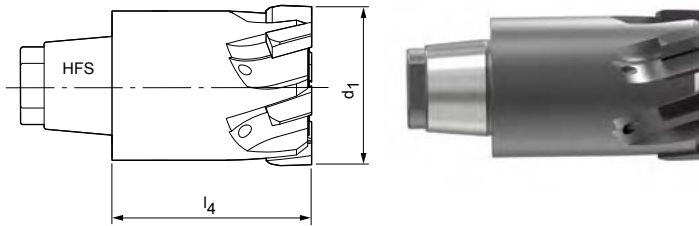

Características configurables



Tolerancia de diámetro del agujero IT5/IT6:

- Diámetro seleccionable libremente en incrementos de 0,001 mm
- En función del rango de diámetros, se puede pedir a partir de la tolerancia IT5/IT6
- > 030,000 IT5 | ≤ 030,000 IT6

Especificación

HPR210Ø[diámetro][tolerancia]ME1G-CU134

Tolerancia de diámetro del agujero < IT5/IT6:

- Las tolerancias inferiores a IT5/IT6 pueden pedirse como diámetro de herramienta especial (para la variante G, véase la página 373)

Especificación de la variante G:

HPR210GØ[diámetro][tolerancia]ME1G-CU134

Dimensiones de la serie configurable IT5/IT6

d_1	l_4	l_5	Tamaño HFS	z	Tolerancia
18,600 - 20,390	25	-	12	6	IT6
20,400 - 21,290	27	-	12	6	IT6
21,300 - 23,990	27	-	14	6	IT6
24,000 - 29,990	35	-	16	6	IT6
30,000 - 39,990	41	-	20	8	IT5
40,000 - 65,000	47	-	24	8	IT5

Ejemplo de tolerancia IT5:

HPR210Ø35.350H5ME1G-CU134

Diámetro del agujero $d_1 = 35,350$ H5

Ejemplo de variante G:

HPR210GØ35.350+1-1ME1G-CU134

Diámetro especial de la herramienta $d_1 = 35,350 +1 \mu\text{m} -1 \mu\text{m}$

Medidas en mm.

Para el correspondiente portaherramientas para cabezal intercambiables HFS, véase a partir de la página 460.

Para la recomendación de valores de corte, véase al final del capítulo.

Escariador de cabezal intercambiable HPR

Ejecución de ajuste de precisión, con ranuras oblicuas a la izquierda, para agujero pasante HPR210

Ejecución:

Diámetro del escariador: 18,600 - 65,000 mm
 Entrada: ME1G
 Material de corte: HP421
 Metal duro con recubrimiento de PVD

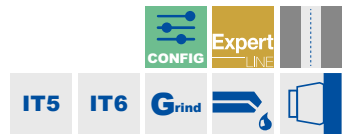
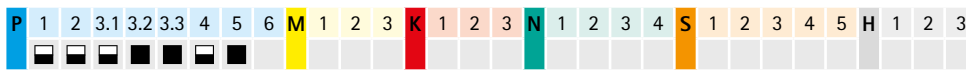
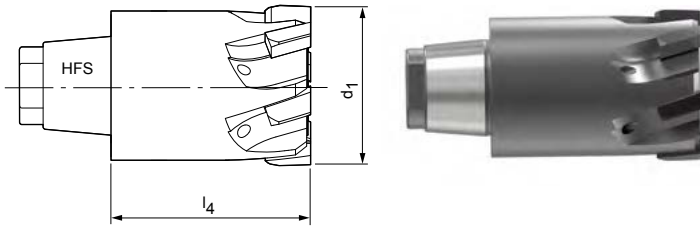

Características configurables



Tolerancia de diámetro del agujero IT5/IT6:
 - Diámetro seleccionable libremente en incrementos de 0,001 mm
 - En función del rango de diámetros, se puede pedir a partir de la tolerancia IT5/IT6
 - > 030,000 IT5 | ≤ 030,000 IT6

Especificación
 HPR210Ø[diámetro][tolerancia]ME1G-HP421

Tolerancia de diámetro del agujero < IT5/IT6:
 - Las tolerancias inferiores a IT5/IT6 pueden pedirse como diámetro de herramienta especial (para la variante G, véase la página 373)

Especificación de la variante G:
 HPR210GØ[diámetro][tolerancia]ME1G-HP421

Dimensiones de la serie configurable IT5/IT6

d ₁	l ₄	l ₅	Tamaño HFS	z	Tolerancia
18,600 - 20,390	25	-	12	6	IT6
20,400 - 21,290	27	-	12	6	IT6
21,300 - 23,990	27	-	14	6	IT6
24,000 - 29,990	35	-	16	6	IT6
30,000 - 39,990	41	-	20	8	IT5
40,000 - 65,000	47	-	24	8	IT5

Ejemplo de tolerancia IT5:
 HPR210Ø35.350H5ME1G-HP421

Diámetro del agujero d₁ = 35,350 H5

Ejemplo de variante G:
 HPR210GØ35.350+1-1ME1G-HP421

Diámetro especial de la herramienta d₁ = 35,350 +1 µm
 -1 µm

Medidas en mm.
 Para el correspondiente portaherramientas para cabezal intercambiables HFS, véase a partir de la página 460.
 Para la recomendación de valores de corte, véase al final del capítulo.

Escariador de cabezal intercambiable HPR

Ejecución de ajuste de precisión, con ranuras oblicuas a la izquierda, para agujero pasante HPR210

Ejecución:

Diámetro del escariador: 18,600 - 65,000 mm
 Entrada: MF1G
 Material de corte: HP421
 Metal duro con recubrimiento de PVD

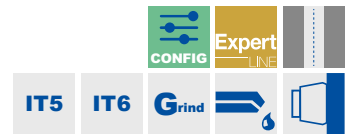
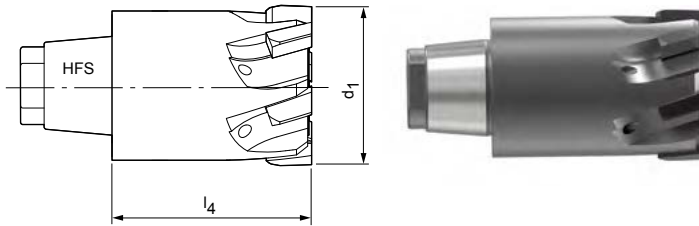

Características configurables



Tolerancia de diámetro del agujero IT5/IT6:

- Diámetro seleccionable libremente en incrementos de 0,001 mm
- En función del rango de diámetros, se puede pedir a partir de la tolerancia IT5/IT6
- > 030,000 IT5 | ≤ 030,000 IT6

Especificación

HPR210Ø[diámetro][tolerancia]MF1G-HP421

Tolerancia de diámetro del agujero < IT5/IT6:

- Las tolerancias inferiores a IT5/IT6 pueden pedirse como diámetro de herramienta especial (para la variante G, véase la página 373)

Especificación de la variante G:

HPR210GØ[diámetro][tolerancia]MF1G-HP421

Dimensiones de la serie configurable IT5/IT6

d ₁	l ₄	l ₅	Tamaño HFS	z	Tolerancia
18,600 - 20,390	25	-	12	6	IT6
20,400 - 21,290	27	-	12	6	IT6
21,300 - 23,990	27	-	14	6	IT6
24,000 - 29,990	35	-	16	6	IT6
30,000 - 39,990	41	-	20	8	IT5
40,000 - 65,000	47	-	24	8	IT5

Ejemplo de tolerancia IT5:

HPR210Ø35.350H5MF1G-HP421

Diámetro del agujero d₁ = 35,350 H5

Ejemplo de variante G:

HPR210GØ35.350+1-1MF1G-HP421

Diámetro especial de la herramienta d₁ = 35,350 +1 μm
 -1 μm

Medidas en mm.

Para el correspondiente portaherramientas para cabezal intercambiables HFS, véase a partir de la página 460.

Para la recomendación de valores de corte, véase al final del capítulo.

Escariador de cabezal intercambiable HPR

Ejecución de ajuste de precisión, con ranuras oblicuas a la izquierda, para agujero pasante HPR210

Ejecución:

Diámetro del escariador: 18,600 - 65,000 mm
 Entrada: MF1G
 Material de corte: HP625
 Metal duro con recubrimiento de PVD

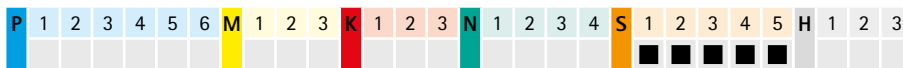
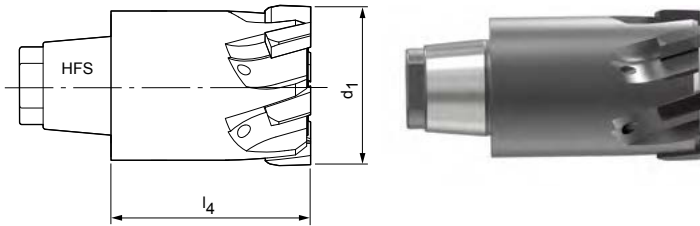

Características configurables



Tolerancia de diámetro del agujero IT5/IT6:
 - Diámetro seleccionable libremente en incrementos de 0,001 mm
 - En función del rango de diámetros, se puede pedir a partir de la tolerancia IT5/IT6
 - > 030,000 IT5 | ≤ 030,000 IT6

Especificación
 HPR210Ø[diámetro][tolerancia]MF1G-HP625

Tolerancia de diámetro del agujero < IT5/IT6:
 - Las tolerancias inferiores a IT5/IT6 pueden pedirse como diámetro de herramienta especial (para la variante G, véase la página 373)

Especificación de la variante G:
 HPR210GØ[diámetro][tolerancia]MF1G-HP625

Dimensiones de la serie configurable IT5/IT6

d ₁	l ₄	l ₅	Tamaño HFS	z	Tolerancia
18,600 - 20,390	25	-	12	6	IT6
20,400 - 21,290	27	-	12	6	IT6
21,300 - 23,990	27	-	14	6	IT6
24,000 - 29,990	35	-	16	6	IT6
30,000 - 39,990	41	-	20	8	IT5
40,000 - 65,000	47	-	24	8	IT5

Ejemplo de tolerancia IT5:
 HPR210Ø35.350H5MF1G-HP625

Diámetro del agujero d₁ = 35,350 H5

Ejemplo de variante G:
 HPR210GØ35.350+1-1MF1G-HP625

Diámetro especial de la herramienta d₁ = 35,350 +1 µm
 -1 µm

Medidas en mm.
 Para el correspondiente portaherramientas para cabezal intercambiables HFS, véase a partir de la página 460.
 Para la recomendación de valores de corte, véase al final del capítulo.

Escariador de cabezal intercambiable HPR

Ejecución de ajuste de precisión, con ranuras rectas, para agujero ciego
HPR280

Ejecución:

Diámetro del escariador: 7,000 - 21,290 mm
Entrada: ML2G
Material de corte: CU134
Cermet sin recubrimiento

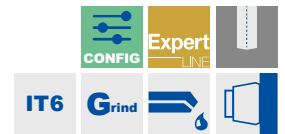
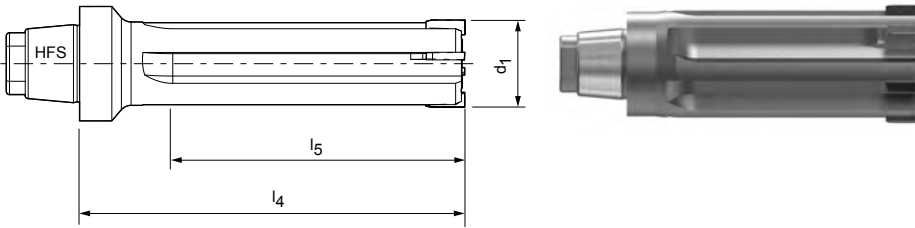

Características configurables



Tolerancia de diámetro del agujero IT6:

- Diámetro seleccionable libremente en incrementos de 0,001 mm
- Se puede pedir en tolerancia IT6

Especificación

HPR280Ø[diámetro][tolerancia]ML2G-CU134

Tolerancia del diámetro del agujero < IT6:

- Las tolerancias inferiores a IT6 pueden pedirse como diámetro de herramienta especial (para la variante G, véase la página 373)

Especificación de la variante G:

HPR280GØ[diámetro][tolerancia]ML2G-CU134

Dimensiones de la serie configurable IT6

d ₁	l ₄	l ₅	Tamaño HFS	z
7,000 - 14,590	60	40	12	4
14,600 - 21,290	60	40	12	6

Ejemplo de tolerancia IT6:

HPR280Ø16.350H6ML2G-CU134

Diámetro del agujero d₁ = 16,350 H6

Ejemplo de variante G:

HPR280GØ16.350+1-1ML2G-CU134

Diámetro especial de la herramienta d₁ = 16,350 +1 μm
-1 μm

Medidas en mm.

Para el correspondiente portaherramientas para cabezal intercambiables HFS, véase a partir de la página 460.

Para la recomendación de valores de corte, véase al final del capítulo.

Escariador de cabezal intercambiable HPR

Ejecución de ajuste de precisión, con ranuras rectas, para agujero ciego
HPR280

Ejecución:

Diámetro del escariador: 7,000 - 21,290 mm
Entrada: ML2G
Material de corte: HP421
Metal duro con recubrimiento de PVD

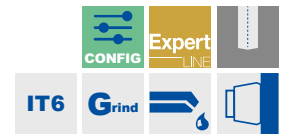
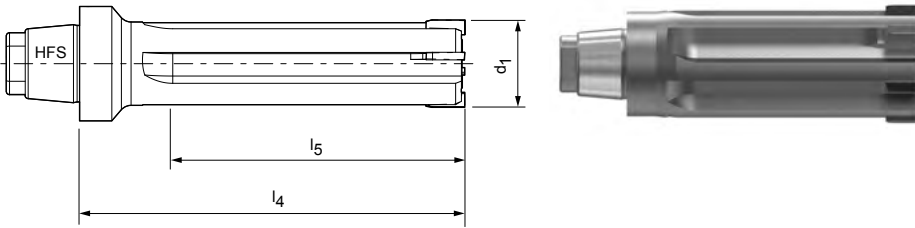

Características configurables



Tolerancia de diámetro del agujero IT6:

- Diámetro seleccionable libremente en incrementos de 0,001 mm
- Se puede pedir en tolerancia IT6

Especificación

HPR280Ø[diámetro][tolerancia]ML2G-HP421

Tolerancia del diámetro del agujero < IT6:

- Las tolerancias inferiores a IT6 pueden pedirse como diámetro de herramienta especial (para la variante G, véase la página 373)

Especificación de la variante G:

HPR280GØ[diámetro][tolerancia]ML2G-HP421

Dimensiones de la serie configurable IT6

d ₁	l ₄	l ₅	Tamaño HFS	z
7,000 - 14,590	60	40	12	4
14,600 - 21,290	60	40	12	6

Ejemplo de tolerancia IT6:

HPR280Ø16.350H6ML2G-HP421

Diámetro del agujero d₁ = 16,350 H6

Ejemplo de variante G:

HPR280GØ16.350+1-1ML2G-HP421

Diámetro especial de la herramienta d₁ = 16,350 +1 μm
-1 μm

Medidas en mm.

Para el correspondiente portaherramientas para cabezal intercambiables HFS, véase a partir de la página 460.

Para la recomendación de valores de corte, véase al final del capítulo.

Escariador de cabezal intercambiable HPR

Ejecución de ajuste de precisión, con ranuras rectas, para agujero ciego
HPR280

Ejecución:

Diámetro del escariador: 7,000 - 21,290 mm
 Entrada: M02G
 Material de corte: HP421
 Metal duro con recubrimiento de PVD

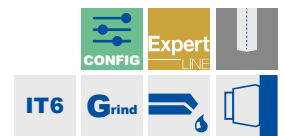
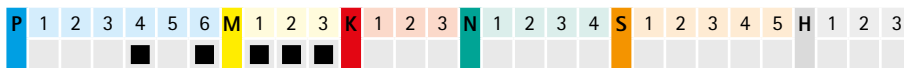
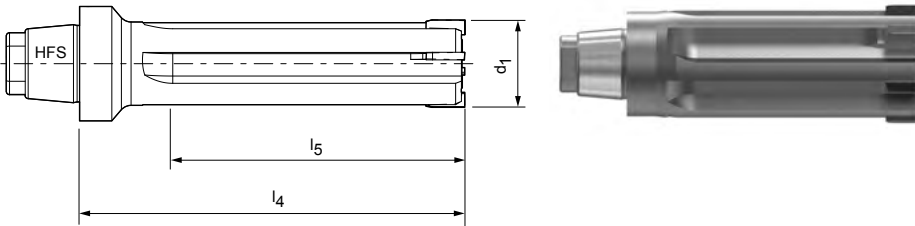

Características configurables



Tolerancia de diámetro del agujero IT6:
 - Diámetro seleccionable libremente en incrementos de 0,001 mm
 - Se puede pedir en tolerancia IT6

Especificación
 HPR280Ø[diámetro][tolerancia]M02G-HP421

Tolerancia del diámetro del agujero < IT6:
 - Las tolerancias inferiores a IT6 pueden pedirse como diámetro de herramienta especial (para la variante G, véase la página 373)

Especificación de la variante G:
 HPR280GØ[diámetro][tolerancia]M02G-HP421

Dimensiones de la serie configurable IT6

d ₁	l ₄	l ₅	Tamaño HFS	z
7,000 - 14,590	60	40	12	4
14,600 - 21,290	60	40	12	6

Ejemplo de tolerancia IT6:
 HPR280Ø16.350H6M02G-HP421

Diámetro del agujero d₁ = 16,350 H6

Ejemplo de variante G:
 HPR280GØ16.350+1-1M02G-HP421

Diámetro especial de la herramienta d₁ = 16,350 +1 µm -1 µm

Medidas en mm.
 Para el correspondiente portaherramientas para cabezal intercambiables HFS, véase a partir de la página 460.
 Para la recomendación de valores de corte, véase al final del capítulo.

Escariador de cabezal intercambiable HPR

Ejecución de ajuste de precisión, con ranuras rectas, para agujero ciego
HPR280

Ejecución:

Diámetro del escariador: 7,000 - 21,290 mm
Entrada: MC1G
Material de corte: CP134
Cermet con recubrimiento de PVD

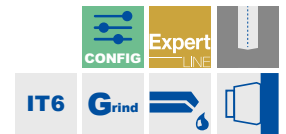
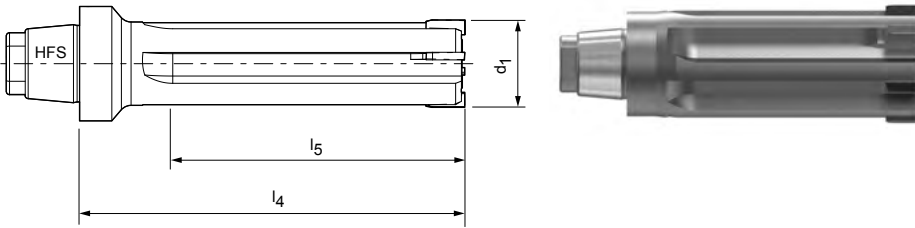

Características configurables



Tolerancia de diámetro del agujero IT6:

- Diámetro seleccionable libremente en incrementos de 0,001 mm
- Se puede pedir en tolerancia IT6

Especificación

HPR280Ø[diámetro][tolerancia]MC1G-CP134

Tolerancia del diámetro del agujero < IT6:

- Las tolerancias inferiores a IT6 pueden pedirse como diámetro de herramienta especial (para la variante G, véase la página 373)

Especificación de la variante G:

HPR280GØ[diámetro][tolerancia]MC1G-CP134

Dimensiones de la serie configurable IT6

d_1	l_4	l_5	Tamaño HFS	z
7,000 - 14,590	60	40	12	4
14,600 - 21,290	60	40	12	6

Ejemplo de tolerancia IT6:

HPR280Ø16.350H6MC1G-CP134

Diámetro del agujero $d_1 = 16,350 \text{ H6}$

Ejemplo de variante G:

HPR280GØ16.350+1-1MC1G-CP134

Diámetro especial de la herramienta $d_1 = 16,350 +1 \mu\text{m} -1 \mu\text{m}$

Medidas en mm.

* para superficies $R_a < 2 \mu\text{m}$

Para el correspondiente portaherramientas para cabezal intercambiables HFS, véase a partir de la página 460.

Para la recomendación de valores de corte, véase al final del capítulo.

Escariador de cabezal intercambiable HPR

Ejecución de ajuste de precisión, con ranuras rectas, para agujero ciego
HPR280

Ejecución:

Diámetro del escariador: 7,000 - 21,290 mm
Entrada: MC1G
Material de corte: HP421
Metal duro con recubrimiento de PVD

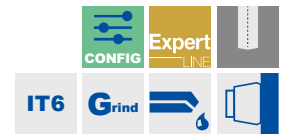
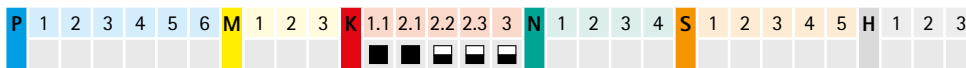
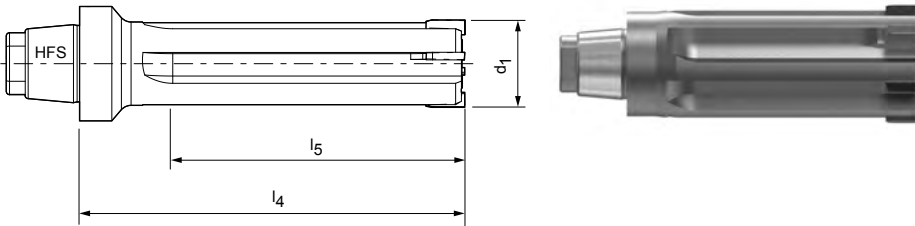

Características configurables



Tolerancia de diámetro del agujero IT6:

- Diámetro seleccionable libremente en incrementos de 0,001 mm
- Se puede pedir en tolerancia IT6

Especificación

HPR280Ø[diámetro][tolerancia]MC1G-HP421

Tolerancia del diámetro del agujero < IT6:

- Las tolerancias inferiores a IT6 pueden pedirse como diámetro de herramienta especial (para la variante G, véase la página 373)

Especificación de la variante G:

HPR280GØ[diámetro][tolerancia]MC1G-HP421

Dimensiones de la serie configurable IT6

d ₁	l ₄	l ₅	Tamaño HFS	z
7,000 - 14,590	60	40	12	4
14,600 - 21,290	60	40	12	6

Ejemplo de tolerancia IT6:

HPR280Ø16.350H6MC1G-HP421

Diámetro del agujero d₁ = 16,350 H6

Ejemplo de variante G:

HPR280GØ16.350+1-1MC1G-HP421

Diámetro especial de la herramienta d₁ = 16,350 +1 μm
-1 μm

Medidas en mm.

Para el correspondiente portaherramientas para cabezal intercambiables HFS, véase a partir de la página 460.

Para la recomendación de valores de corte, véase al final del capítulo.

Escariador de cabezal intercambiable HPR

Ejecución de ajuste de precisión, con ranuras rectas, para agujero ciego
HPR280

Ejecución:

Diámetro del escariador: 7,000 - 21,290 mm
Entrada: MC1G
Material de corte: HP423
Metal duro con recubrimiento de PVD

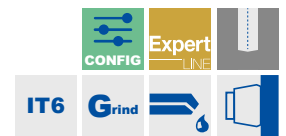
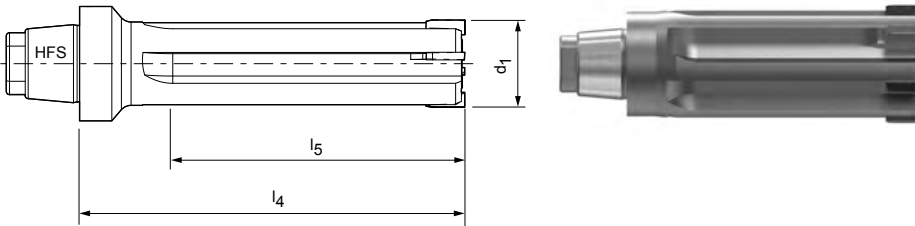

Características configurables



Tolerancia de diámetro del agujero IT6:

- Diámetro seleccionable libremente en incrementos de 0,001 mm
- Se puede pedir en tolerancia IT6

Especificación

HPR280Ø[diámetro][tolerancia]MC1G-HP423

Tolerancia del diámetro del agujero < IT6:

- Las tolerancias inferiores a IT6 pueden pedirse como diámetro de herramienta especial (para la variante G, véase la página 373)

Especificación de la variante G:

HPR280GØ[diámetro][tolerancia]MC1G-HP423

Dimensiones de la serie configurable IT6

d ₁	l ₄	l ₅	Tamaño HFS	z
7,000 - 14,590	60	40	12	4
14,600 - 21,290	60	40	12	6

Ejemplo de tolerancia IT6:

HPR280Ø16.350H6MC1G-HP423

Diámetro del agujero d₁ = 16,350 H6

Ejemplo de variante G:

HPR280GØ16.350+1-1MC1G-HP423

Diámetro especial de la herramienta d₁ = 16,350 +1 µm
-1 µm

Medidas en mm.

Para el correspondiente portaherramientas para cabezal intercambiables HFS, véase a partir de la página 460.

Para la recomendación de valores de corte, véase al final del capítulo.

Escariador de cabezal intercambiable HPR

Ejecución de ajuste de precisión, con ranuras rectas, para agujero ciego
HPR280

Ejecución:

Diámetro del escariador: 7,000 - 21,290 mm
Entrada: MA0A
Material de corte: PU620
De PCD

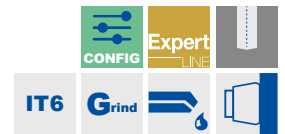
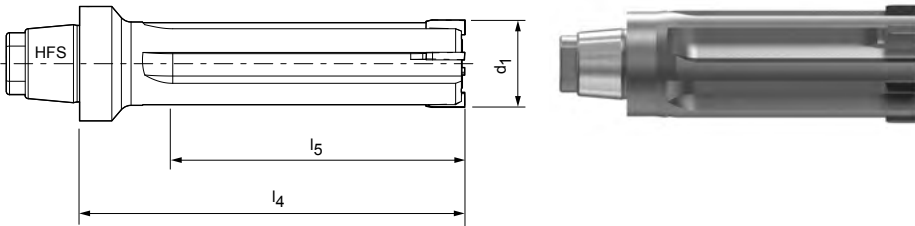

Características configurables



Tolerancia de diámetro del agujero IT6:

- Diámetro seleccionable libremente en incrementos de 0,001 mm
- Se puede pedir en tolerancia IT6

Especificación

HPR280Ø[diámetro][tolerancia]MA0A-PU620

Tolerancia del diámetro del agujero < IT6:

- Las tolerancias inferiores a IT6 pueden pedirse como diámetro de herramienta especial (para la variante G, véase la página 373)

Especificación de la variante G:

HPR280GØ[diámetro][tolerancia]MA0A-PU620

Dimensiones de la serie configurable IT6

d_1	l_4	l_5	Tamaño HFS	z
7,000 - 14,590	60	40	12	4
14,600 - 21,290	60	40	12	6

Ejemplo de tolerancia IT6:

HPR280Ø16.350H6MA0A-PU620

Diámetro del agujero $d_1 = 16,350 \text{ H6}$

Ejemplo de variante G:

HPR280GØ16.350+1-1MA0A-PU620

Diámetro especial de la herramienta $d_1 = 16,350 +1 \mu\text{m} -1 \mu\text{m}$

Medidas en mm.

Para el correspondiente portaherramientas para cabezal intercambiables HFS, véase a partir de la página 460.

Para la recomendación de valores de corte, véase al final del capítulo.

Escariador de cabezal intercambiable HPR

Ejecución de ajuste de precisión, con ranuras rectas, para agujero ciego
HPR280

Ejecución:

Diámetro del escariador: 7,000 - 21,290 mm
Entrada: M02G
Material de corte: HP625
Metal duro con recubrimiento de PVD

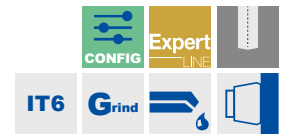
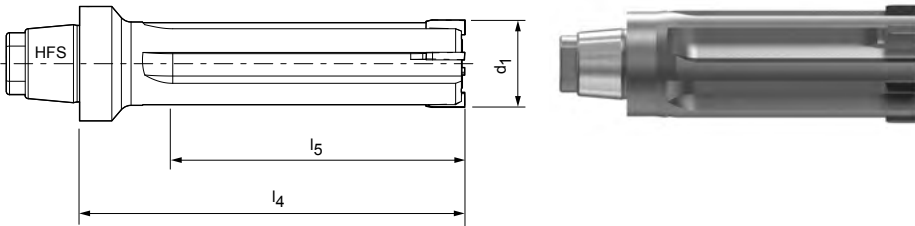

Características configurables



Tolerancia de diámetro del agujero IT6:

- Diámetro seleccionable libremente en incrementos de 0,001 mm
- Se puede pedir en tolerancia IT6

Especificación

HPR280Ø[diámetro][tolerancia]M02G-HP625

Tolerancia del diámetro del agujero < IT6:

- Las tolerancias inferiores a IT6 pueden pedirse como diámetro de herramienta especial (para la variante G, véase la página 373)

Especificación de la variante G:

HPR280GØ[diámetro][tolerancia]M02G-HP625

Dimensiones de la serie configurable IT6

d ₁	l ₄	l ₅	Tamaño HFS	z
7,000 - 14,590	60	40	12	4
14,600 - 21,290	60	40	12	6

Ejemplo de tolerancia IT6:

HPR280Ø16.350H6M02G-HP625

Diámetro del agujero d₁ = 16,350 H6

Ejemplo de variante G:

HPR280GØ16.350+1-1M02G-HP625

Diámetro especial de la herramienta d₁ = 16,350 +1 µm
-1 µm

Medidas en mm.

Para el correspondiente portaherramientas para cabezal intercambiables HFS, véase a partir de la página 460.

Para la recomendación de valores de corte, véase al final del capítulo.

Escariador de cabezal intercambiable HPR

Ejecución de ajuste de precisión, con ranuras rectas, para agujero ciego
HPR250

Ejecución:

Diámetro del escariador: 16,600 - 65,000 mm
Entrada: ML2G
Material de corte: CU134
Cermet sin recubrimiento

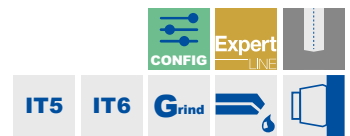
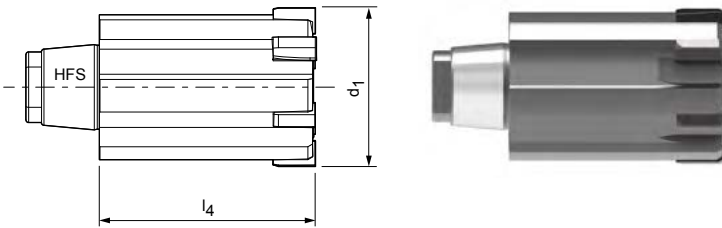

Características configurables



Tolerancia de diámetro del agujero IT5/IT6:

- Diámetro seleccionable libremente en incrementos de 0,001 mm
- En función del rango de diámetros, se puede pedir a partir de la tolerancia IT5/IT6
- > 030,000 IT5 | ≤ 030,000 IT6

Especificación

HPR250Ø[diámetro][tolerancia]ML2G-CU134

Tolerancia de diámetro del agujero < IT5/IT6:

- Las tolerancias inferiores a IT5/IT6 pueden pedirse como diámetro de herramienta especial (para la variante G, véase la página 373)

Especificación de la variante G:

HPR250GØ[diámetro][tolerancia]ML2G-CU134

Dimensiones de la serie configurable IT5/IT6

d_1	l_4	l_5	Tamaño HFS	z	Tolerancia
16,600 - 21,290	25	-	10	6	IT6
21,300 - 24,990	27	-	12	6	IT6
25,000 - 28,590	35	-	14	6	IT6
29,000 - 32,290	35	-	16	6	IT5
32,300 - 36,990	41	-	16	6	IT5
37,000 - 41,190	41	-	20	8	IT5
41,200 - 44,900	47	-	20	8	IT5
45,000 - 65,000	47	-	24	8	IT5

Ejemplo de tolerancia IT5:

HPR250Ø35.350H5ML2G-CU134

Diámetro del agujero $d_1 = 35,350$ H5

Ejemplo de variante G:

HPR250GØ35.350+1-1ML2G-CU134

Diámetro especial de la herramienta $d_1 = 35,350 +1 \mu\text{m} -1 \mu\text{m}$

Medidas en mm.

Para el correspondiente portaherramientas para cabezal intercambiables HFS, véase a partir de la página 460.

Para la recomendación de valores de corte, véase al final del capítulo.

Escariador de cabezal intercambiable HPR

Ejecución de ajuste de precisión, con ranuras rectas, para agujero ciego
HPR250

Ejecución:

Diámetro del escariador: 16,600 - 65,000 mm
Entrada: ML2G
Material de corte: HP421
Metal duro con recubrimiento de PVD

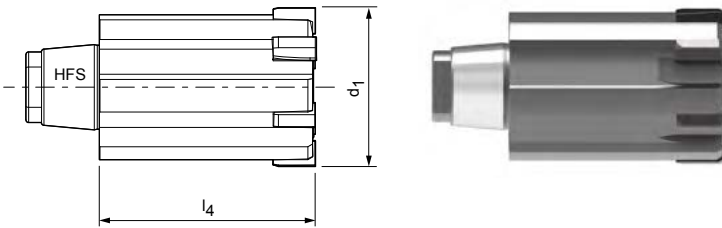

Características configurables



Tolerancia de diámetro del agujero IT5/IT6:

- Diámetro seleccionable libremente en incrementos de 0,001 mm
- En función del rango de diámetros, se puede pedir a partir de la tolerancia IT5/IT6
- > 030,000 IT5 | ≤ 030,000 IT6

Especificación

HPR250Ø[diámetro][tolerancia]ML2G-HP421

Tolerancia de diámetro del agujero < IT5/IT6:

- Las tolerancias inferiores a IT5/IT6 pueden pedirse como diámetro de herramienta especial (para la variante G, véase la página 373)

Especificación de la variante G:

HPR250GØ[diámetro][tolerancia]ML2G-HP421

Dimensiones de la serie configurable IT5/IT6

d_1	l_4	l_5	Tamaño HFS	z	Tolerancia
16,600 - 21,290	25	-	10	6	IT6
21,300 - 24,990	27	-	12	6	IT6
25,000 - 28,590	35	-	14	6	IT6
29,000 - 32,290	35	-	16	6	IT5
32,300 - 36,990	41	-	16	6	IT5
37,000 - 41,190	41	-	20	8	IT5
41,200 - 44,900	47	-	20	8	IT5
45,000 - 65,000	47	-	24	8	IT5

Ejemplo de tolerancia IT5:

HPR250Ø35.350H5ML2G-HP421

Diámetro del agujero $d_1 = 35,350$ H5

Ejemplo de variante G:

HPR250GØ35.350+1-1ML2G-HP421

Diámetro especial de la herramienta $d_1 = 35,350 +1 \mu\text{m} -1 \mu\text{m}$

Medidas en mm.

Para el correspondiente portaherramientas para cabezal intercambiables HFS, véase a partir de la página 460.

Para la recomendación de valores de corte, véase al final del capítulo.

Escariador de cabezal intercambiable HPR

Ejecución de ajuste de precisión, con ranuras rectas, para agujero ciego
HPR250

Ejecución:

Diámetro del escariador: 16,600 - 65,000 mm
Entrada: M02G
Material de corte: HP421
Metal duro con recubrimiento de PVD

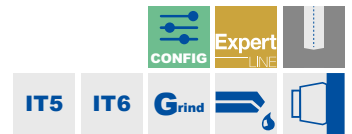
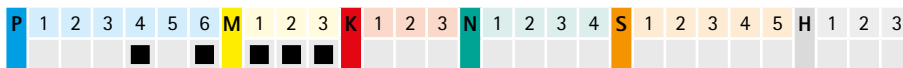
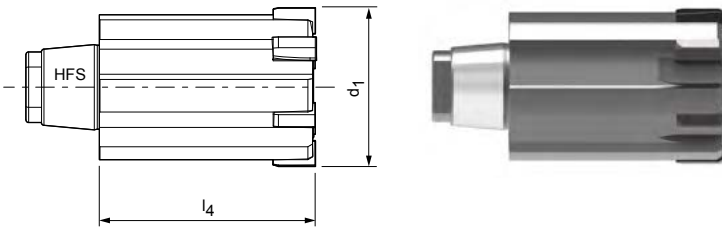

Características configurables



Tolerancia de diámetro del agujero IT5/IT6:

- Diámetro seleccionable libremente en incrementos de 0,001 mm
- En función del rango de diámetros, se puede pedir a partir de la tolerancia IT5/IT6
- > 030,000 IT5 | ≤ 030,000 IT6

Especificación

HPR250Ø[diámetro][tolerancia]M02G-HP421

Tolerancia de diámetro del agujero < IT5/IT6:

- Las tolerancias inferiores a IT5/IT6 pueden pedirse como diámetro de herramienta especial (para la variante G, véase la página 373)

Especificación de la variante G:

HPR250GØ[diámetro][tolerancia]M02G-HP421

Dimensiones de la serie configurable IT5/IT6

d_1	l_4	l_5	Tamaño HFS	z	Tolerancia
16,600 - 21,290	25	-	10	6	IT6
21,300 - 24,990	27	-	12	6	IT6
25,000 - 28,590	35	-	14	6	IT6
29,000 - 32,290	35	-	16	6	IT5
32,300 - 36,990	41	-	16	6	IT5
37,000 - 41,190	41	-	20	8	IT5
41,200 - 44,900	47	-	20	8	IT5
45,000 - 65,000	47	-	24	8	IT5

Ejemplo de tolerancia IT5:

HPR250Ø35.350H5M02G-HP421

Diámetro del agujero $d_1 = 35,350$ H5

Ejemplo de variante G:

HPR250GØ35.350+1-1M02G-HP421

Diámetro especial de la herramienta $d_1 = 35,350 +1 \mu\text{m} -1 \mu\text{m}$

Medidas en mm.

Para el correspondiente portaherramientas para cabezal intercambiables HFS, véase a partir de la página 460.

Para la recomendación de valores de corte, véase al final del capítulo.

Escariador de cabezal intercambiable HPR

Ejecución de ajuste de precisión, con ranuras rectas, para agujero ciego
HPR250

Ejecución:

Diámetro del escariador: 16,600 - 65,000 mm
Entrada: MC1G
Material de corte: CP134
Cermet con recubrimiento de PVD

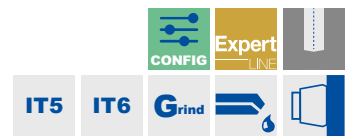
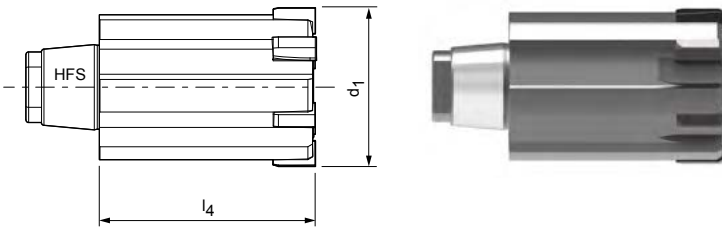

Características configurables



Tolerancia de diámetro del agujero IT5/IT6:

- Diámetro seleccionable libremente en incrementos de 0,001 mm
- En función del rango de diámetros, se puede pedir a partir de la tolerancia IT5/IT6
- > 030,000 IT5 | ≤ 030,000 IT6

Especificación

HPR250Ø[diámetro][tolerancia]MC1G-CP134

Tolerancia de diámetro del agujero < IT5/IT6:

- Las tolerancias inferiores a IT5/IT6 pueden pedirse como diámetro de herramienta especial (para la variante G, véase la página 373)

Especificación de la variante G:

HPR250GØ[diámetro][tolerancia]MC1G-CP134

Dimensiones de la serie configurable IT5/IT6

d_1	l_4	l_5	Tamaño HFS	z	Tolerancia
16,600 - 21,290	25	-	10	6	IT6
21,300 - 24,990	27	-	12	6	IT6
25,000 - 28,590	35	-	14	6	IT6
29,000 - 32,290	35	-	16	6	IT5
32,300 - 36,990	41	-	16	6	IT5
37,000 - 41,190	41	-	20	8	IT5
41,200 - 44,900	47	-	20	8	IT5
45,000 - 65,000	47	-	24	8	IT5

Ejemplo de tolerancia IT5:

HPR250Ø35.350H5MC1G-CP134

Diámetro del agujero $d_1 = 35,350$ H5

Ejemplo de variante G:

HPR250GØ35.350+1-1MC1G-CP134

Diámetro especial de la herramienta $d_1 = 35,350 +1 \mu\text{m}$
 $-1 \mu\text{m}$

Medidas en mm.

* para superficies $R_a < 2 \mu\text{m}$

Para el correspondiente portaherramientas para cabezal intercambiables HFS, véase a partir de la página 460.

Para la recomendación de valores de corte, véase al final del capítulo.

Escariador de cabezal intercambiable HPR

Ejecución de ajuste de precisión, con ranuras rectas, para agujero ciego
HPR250

Ejecución:

Diámetro del escariador: 16,600 - 65,000 mm
Entrada: MC1G
Material de corte: HP421
Metal duro con recubrimiento de PVD

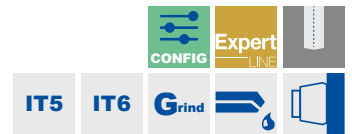
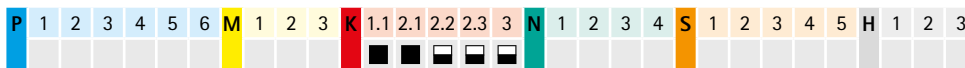
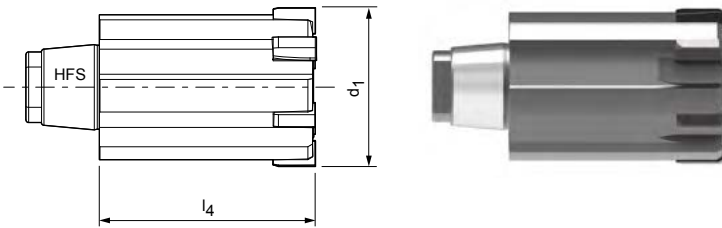

Características configurables



Tolerancia de diámetro del agujero IT5/IT6:

- Diámetro seleccionable libremente en incrementos de 0,001 mm
- En función del rango de diámetros, se puede pedir a partir de la tolerancia IT5/IT6
- > 030,000 IT5 | ≤ 030,000 IT6

Especificación

HPR250Ø[diámetro][tolerancia]MC1G-HP421

Tolerancia de diámetro del agujero < IT5/IT6:

- Las tolerancias inferiores a IT5/IT6 pueden pedirse como diámetro de herramienta especial (para la variante G, véase la página 373)

Especificación de la variante G:

HPR250GØ[diámetro][tolerancia]MC1G-HP421

Dimensiones de la serie configurable IT5/IT6

d_1	l_4	l_5	Tamaño HFS	z	Tolerancia
16,600 - 21,290	25	-	10	6	IT6
21,300 - 24,990	27	-	12	6	IT6
25,000 - 28,590	35	-	14	6	IT6
29,000 - 32,290	35	-	16	6	IT5
32,300 - 36,990	41	-	16	6	IT5
37,000 - 41,190	41	-	20	8	IT5
41,200 - 44,900	47	-	20	8	IT5
45,000 - 65,000	47	-	24	8	IT5

Ejemplo de tolerancia IT5:

HPR250Ø35.350H5MC1G-HP421

Diámetro del agujero $d_1 = 35,350$ H5

Ejemplo de variante G:

HPR250GØ35.350+1-1MC1G-HP421

Diámetro especial de la herramienta $d_1 = 35,350 +1 \mu\text{m} -1 \mu\text{m}$

Medidas en mm.

Para el correspondiente portaherramientas para cabezal intercambiables HFS, véase a partir de la página 460.

Para la recomendación de valores de corte, véase al final del capítulo.

Escariador de cabezal intercambiable HPR

Ejecución de ajuste de precisión, con ranuras rectas, para agujero ciego
HPR250

Ejecución:

Diámetro del escariador: 16,600 - 65,000 mm
Entrada: MC1G
Material de corte: HP423
Metal duro con recubrimiento de PVD

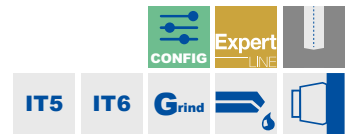
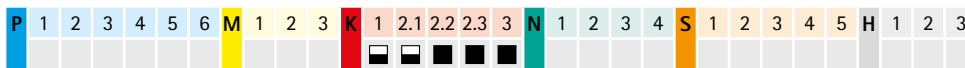
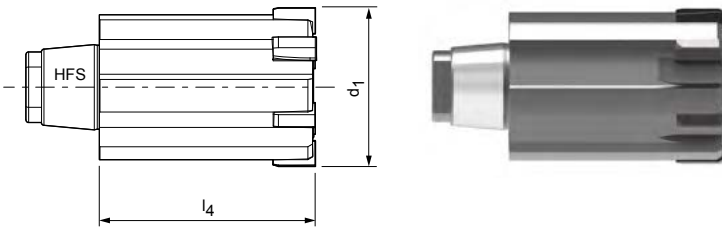

Características configurables



Tolerancia de diámetro del agujero IT5/IT6:

- Diámetro seleccionable libremente en incrementos de 0,001 mm
- En función del rango de diámetros, se puede pedir a partir de la tolerancia IT5/IT6
- > 030,000 IT5 | ≤ 030,000 IT6

Especificación

HPR250Ø[diámetro][tolerancia]MC1G-HP423

Tolerancia de diámetro del agujero < IT5/IT6:

- Las tolerancias inferiores a IT5/IT6 pueden pedirse como diámetro de herramienta especial (para la variante G, véase la página 373)

Especificación de la variante G:

HPR250GØ[diámetro][tolerancia]MC1G-HP423

Dimensiones de la serie configurable IT5/IT6

d_1	l_4	l_5	Tamaño HFS	z	Tolerancia
16,600 - 21,290	25	-	10	6	IT6
21,300 - 24,990	27	-	12	6	IT6
25,000 - 28,590	35	-	14	6	IT6
29,000 - 32,290	35	-	16	6	IT5
32,300 - 36,990	41	-	16	6	IT5
37,000 - 41,190	41	-	20	8	IT5
41,200 - 44,900	47	-	20	8	IT5
45,000 - 65,000	47	-	24	8	IT5

Ejemplo de tolerancia IT5:

HPR250Ø35.350H5MC1G-HP423

Diámetro del agujero $d_1 = 35,350$ H5

Ejemplo de variante G:

HPR250GØ35.350+1-1MC1G-HP423

Diámetro especial de la herramienta $d_1 = 35,350 +1 \mu\text{m} -1 \mu\text{m}$

Medidas en mm.

Para el correspondiente portaherramientas para cabezal intercambiables HFS, véase a partir de la página 460.

Para la recomendación de valores de corte, véase al final del capítulo.

Escariador de cabezal intercambiable HPR

Ejecución de ajuste de precisión, con ranuras rectas, para agujero ciego
HPR250

Ejecución:

Diámetro del escariador: 16,600 - 65,000 mm
Entrada: MA0A
Material de corte: PU620
De PCD

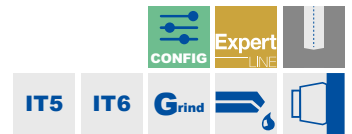
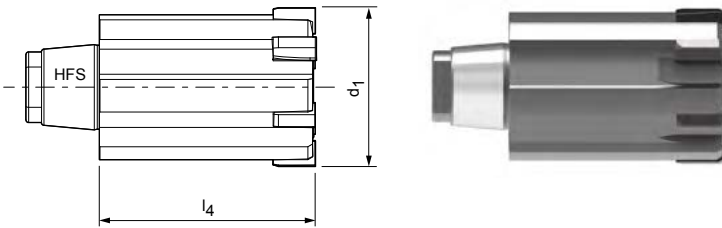

Características configurables



Tolerancia de diámetro del agujero IT5/IT6:

- Diámetro seleccionable libremente en incrementos de 0,001 mm
- En función del rango de diámetros, se puede pedir a partir de la tolerancia IT5/IT6
- > 030,000 IT5 | ≤ 030,000 IT6

Especificación

HPR250Ø[diámetro][tolerancia]MA0A-PU620

Tolerancia de diámetro del agujero < IT5/IT6:

- Las tolerancias inferiores a IT5/IT6 pueden pedirse como diámetro de herramienta especial (para la variante G, véase la página 373)

Especificación de la variante G:

HPR250GØ[diámetro][tolerancia]MA0A-PU620

Dimensiones de la serie configurable IT5/IT6

d_1	l_4	l_5	Tamaño HFS	z	Tolerancia
16,600 - 21,290	25	-	10	6	IT6
21,300 - 24,990	27	-	12	6	IT6
25,000 - 28,590	35	-	14	6	IT6
29,000 - 32,290	35	-	16	6	IT5
32,300 - 36,990	41	-	16	6	IT5
37,000 - 41,190	41	-	20	8	IT5
41,200 - 44,900	47	-	20	8	IT5
45,000 - 65,000	47	-	24	8	IT5

Ejemplo de tolerancia IT5:

HPR250Ø35.350H5MA0A-PU620

Diámetro del agujero $d_1 = 35,350$ H5

Ejemplo de variante G:

HPR250GØ35.350+1-1MA0A-PU620

Diámetro especial de la herramienta $d_1 = 35,350 +1 \mu\text{m} -1 \mu\text{m}$

Medidas en mm.

Para el correspondiente portaherramientas para cabezal intercambiables HFS, véase a partir de la página 460.

Para la recomendación de valores de corte, véase al final del capítulo.

Escariador de cabezal intercambiable HPR

Ejecución de ajuste de precisión, con ranuras rectas, para agujero ciego
HPR250

Ejecución:

Diámetro del escariador: 16,600 - 65,000 mm
Entrada: M02G
Material de corte: HP625
Metal duro con recubrimiento de PVD

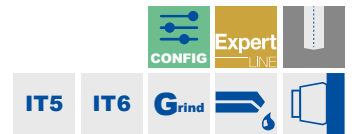
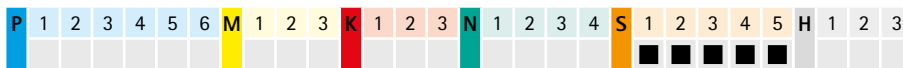
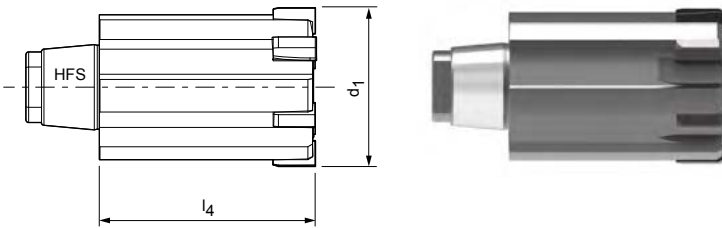

Características configurables



Tolerancia de diámetro del agujero IT5/IT6:

- Diámetro seleccionable libremente en incrementos de 0,001 mm
- En función del rango de diámetros, se puede pedir a partir de la tolerancia IT5/IT6
- > 030,000 IT5 | ≤ 030,000 IT6

Especificación

HPR250Ø[diámetro][tolerancia]M02G-HP625

Tolerancia de diámetro del agujero < IT5/IT6:

- Las tolerancias inferiores a IT5/IT6 pueden pedirse como diámetro de herramienta especial (para la variante G, véase la página 373)

Especificación de la variante G:

HPR250GØ[diámetro][tolerancia]M02G-HP625

Dimensiones de la serie configurable IT5/IT6

d_1	l_4	l_5	Tamaño HFS	z	Tolerancia
16,600 - 21,290	25	-	10	6	IT6
21,300 - 24,990	27	-	12	6	IT6
25,000 - 28,590	35	-	14	6	IT6
29,000 - 32,290	35	-	16	6	IT5
32,300 - 36,990	41	-	16	6	IT5
37,000 - 41,190	41	-	20	8	IT5
41,200 - 44,900	47	-	20	8	IT5
45,000 - 65,000	47	-	24	8	IT5

Ejemplo de tolerancia IT5:

HPR250Ø35.350H5M02G-HP625

Diámetro del agujero $d_1 = 35,350$ H5

Ejemplo de variante G:

HPR250GØ35.350+1-1M02G-HP625

Diámetro especial de la herramienta $d_1 = 35,350 +1 \mu\text{m} -1 \mu\text{m}$

Medidas en mm.

Para el correspondiente portaherramientas para cabezal intercambiables HFS, véase a partir de la página 460.

Para la recomendación de valores de corte, véase al final del capítulo.

Recomendación de valores de corte para escariadores de cabezal intercambiable HPR

Avance y velocidad de corte

HPR131 | HPR231 | HPR180 | HPR280

Material de corte: HP421 | Entrada: ME1G | ML2G

Grupo de arranque de virutas de Mapal*	Material	Rigidez/dureza [N/mm ²] [HRC]	Velocidad de corte v _c (m/min)			Avance f _z (mm/z) con diámetro de herramienta	
			Refrigeración interna	Refrigeración exterior	MMS	z 4	z 6
						7,000 - 9,590	9,600 - 21,290
P	P3.1	Aceros para herramientas, rodamientos, resortes y rápidos**	< 800				
	P3.2	Aceros para herramientas, rodamientos, resortes y rápidos**	< 1000	100	100	120	0,100
	P3.3	Aceros para herramientas, rodamientos, resortes y rápidos**	< 1500	100	100	120	0,100
	P5.1	Fundición de acero		35	35	35	0,070

HPR150 | HPR250

Material de corte: CU134 | Entrada: ML2G

Grupo de arranque de virutas de Mapal*	Material	Rigidez/dureza [N/mm ²] [HRC]	Velocidad de corte v _c (m/min)			Avance f _z (mm/z) con diámetro de herramienta	
			Refrigeración interna	Refrigeración exterior	MMS	z 6	z 8
						16,600 - 36,990	37,000 - 65,000
P	P1.1	Aceros de construcción, para tornos automáticos, de cementación y revenidos, no aleados	< 700	140	100	120	0,200
	P1.2	Aceros de construcción, para tornos automáticos, de cementación y revenidos, no aleados	< 1200	140	100	120	0,200
	P2.1	Aceros nitruados, de cementación y aceros revenidos, aleados	< 900	140	100	120	0,200
	P2.2	Aceros nitruados, de cementación y aceros revenidos, aleados	< 1400	140	100	120	0,200
	P3.1	Aceros para herramientas, rodamientos, resortes y rápidos**	< 800	140	100	120	0,200
	P3.2	Aceros para herramientas, rodamientos, resortes y rápidos**	< 1000				
	P3.3	Aceros para herramientas, rodamientos, resortes y rápidos**	< 1500				

HPR180 | HPR280

Material de corte: CU134 | Entrada: ML2G

Grupo de arranque de virutas de Mapal*	Material	Rigidez/dureza [N/mm ²] [HRC]	Velocidad de corte v _c (m/min)			Avance f _z (mm/z) con diámetro de herramienta	
			Refrigeración interna	Refrigeración exterior	MMS	z 4	z 6
						7,000 - 14,590	14,600 - 21,290
P	P1.1	Aceros de construcción, para tornos automáticos, de cementación y revenidos, no aleados	< 700	140	100	120	0,150
	P1.2	Aceros de construcción, para tornos automáticos, de cementación y revenidos, no aleados	< 1200	140	100	120	0,150
	P2.1	Aceros nitruados, de cementación y aceros revenidos, aleados	< 900	140	100	120	0,150
	P2.2	Aceros nitruados, de cementación y aceros revenidos, aleados	< 1400	140	100	120	0,150
	P3.1	Aceros para herramientas, rodamientos, resortes y rápidos**	< 800	140	100	120	0,150
	P3.2	Aceros para herramientas, rodamientos, resortes y rápidos**	< 1000				
	P3.3	Aceros para herramientas, rodamientos, resortes y rápidos**	< 1500				

* Grupos de mecanizado MAPAL

** Si los componentes de aleación de Cr, Mo, Ni, V, W suman > 8 %, elegir el siguiente grupo de mecanizado MAPAL superior.

HPR110 | HPR210 | HPR150 | HPR250

Material de corte: HP421 | Entrada: ME1G | ML2G

Grupo de arranque de virutas de Mapal*	Material	Rigidez/dureza [N/mm ²] [HRC]	Velocidad de corte v _c (m/min)			Avance f _z (mm/z) con diámetro de herramienta		
			Refrigeración interna	Refrigeración exterior	MMS	z 6	z 8	
						15,600 - 29,990	30,00 - 65,00	
P	P3.1	Aceros para herramientas, rodamientos, resortes y rápidos**	< 800	120	100	120	0,200	0,200
	P3.2	Aceros para herramientas, rodamientos, resortes y rápidos**	< 1000	100	100	120	0,200	0,200
	P3.3	Aceros para herramientas, rodamientos, resortes y rápidos**	< 1500	100	100	120	0,200	0,200
	P5.1	Fundición de acero		35	35	35	0,070	0,070

HPR110 | HPR210

Material de corte: CU134 | Entrada: ME1G

Grupo de arranque de virutas de Mapal*	Material	Rigidez/dureza [N/mm ²] [HRC]	Velocidad de corte v _c (m/min)			Avance f _z (mm/z) con diámetro de herramienta		
			Refrigeración interna	Refrigeración exterior	MMS	z 6	z 8	
						15,600 - 29,990	30,000 - 65,000	
P	P1.1	Aceros de construcción, para tornos automáticos, de cementación y revenidos, no aleados	< 700	140	100	120	0,200	0,250
	P1.2	Aceros de construcción, para tornos automáticos, de cementación y revenidos, no aleados	< 1200	140	100	120	0,200	0,250
	P2.1	Aceros nitrurados, de cementación y aceros revenidos, aleados	< 900	140	100	120	0,200	0,250
	P2.2	Aceros nitrurados, de cementación y aceros revenidos, aleados	< 1400	140	100	120	0,200	0,250
	P3.1	Aceros para herramientas, rodamientos, resortes y rápidos**	< 800	140	100	120	0,200	0,250
	P3.2	Aceros para herramientas, rodamientos, resortes y rápidos**	< 1000					
	P3.3	Aceros para herramientas, rodamientos, resortes y rápidos**	< 1500					

HPR131 | HPR231

Material de corte: CU134 | Entrada: ME1G

Grupo de arranque de virutas de Mapal*	Material	Rigidez/dureza [N/mm ²] [HRC]	Velocidad de corte v _c (m/min)			Avance f _z (mm/z) con diámetro de herramienta		
			Refrigeración interna	Refrigeración exterior	MMS	z 4	z 6	
						7,000 - 9,590	9,600 - 18,590	
P	P1.1	Aceros de construcción, para tornos automáticos, de cementación y revenidos, no aleados	< 700	140	100	120	0,150	0,200
	P1.2	Aceros de construcción, para tornos automáticos, de cementación y revenidos, no aleados	< 1200	140	100	120	0,150	0,200
	P2.1	Aceros nitrurados, de cementación y aceros revenidos, aleados	< 900	140	100	120	0,150	0,200
	P2.2	Aceros nitrurados, de cementación y aceros revenidos, aleados	< 1400	140	100	120	0,150	0,200
	P3.1	Aceros para herramientas, rodamientos, resortes y rápidos**	< 800	140	100	120	0,150	0,200
	P3.2	Aceros para herramientas, rodamientos, resortes y rápidos**	< 1000					
	P3.3	Aceros para herramientas, rodamientos, resortes y rápidos**	< 1500					

Los valores de corte indicados son de referencia.

Los datos óptimos para cada situación de mecanizado deben determinarse mediante ensayos o durante el propio proceso de mecanizado.

Recomendación de valores de corte para escariadores de cabezal intercambiable HPR

Avance y velocidad de corte

HPR131 | HPR231 | HPR180 | HPR280

Material de corte: HP421 | Entrada: MF1G | MO2G

Grupo de arranque de virutas de Mapal*	Material	Rigidez/dureza [N/mm ²] [HRC]	Velocidad de corte v _c (m/min)		
			Refrigeración interna	Refrigeración exterior	MMS
P	P4 P4.1	Aceros inoxidable, ferríticos y martensíticos	35	35	35
	P6 P6.1	Fundición de acero inoxidable, ferrítica y martensítica	35	35	35
M	M1.1	Aceros inoxidable, austeníticos	< 700	35	35
	M1.2	Aceros inoxidable, ferríticos/austeníticos (dúplex)	< 1000	35	35
	M2.1	Fundición de acero inoxidable, austenítica	< 700	35	35
	M3.1	Fundición de acero inoxidable, ferrítica/austenítica (dúplex)	< 1000	35	35

HPR110 | HPR210 | HPR150 | HPR250

Material de corte: HP421 | Entrada: MF1G | MO2G

Grupo de arranque de virutas de Mapal*	Material	Rigidez/dureza [N/mm ²] [HRC]	Velocidad de corte v _c (m/min)		
			Refrigeración interna	Refrigeración exterior	MMS
P	P4 P4.1	Aceros inoxidable, ferríticos y martensíticos	35	35	35
	P6 P6.1	Fundición de acero inoxidable, ferrítica y martensítica	35	35	35
M	M1.1	Aceros inoxidable, austeníticos	< 700	35	35
	M1.2	Aceros inoxidable, ferríticos/austeníticos (dúplex)	< 1000	35	35
	M2.1	Fundición de acero inoxidable, austenítica	< 700	35	35
	M3.1	Fundición de acero inoxidable, ferrítica/austenítica (dúplex)	< 1000	35	35

Avance f_z (mm/z) con diámetro de herramienta			
HPR131 HPR231		HPR180 HPR280	
z4	z6	z4	z6
7,000-9,590	9,600-18,590	7,000-14,590	14,600-21,290
0,070	0,070	0,070	0,070
0,070	0,070	0,070	0,070
0,070	0,070	0,070	0,070
0,070	0,070	0,070	0,070
0,070	0,070	0,070	0,070

Avance f_z (mm/z) con diámetro de herramienta			
HPR110 HPR210		HPR150 HPR250	
z6	z8	z6	z8
15,600-29,990	30,000-65,000	16,600-36,990	37,000-65,000
0,070	0,070	0,070	0,070
0,070	0,070	0,070	0,070
0,070	0,070	0,070	0,070
0,070	0,070	0,070	0,070
0,070	0,070	0,070	0,070

Los valores de corte indicados son de referencia.

Los datos óptimos para cada situación de mecanizado deben determinarse mediante ensayos o durante el propio proceso de mecanizado.

Recomendación de valores de corte para escariadores de cabezal intercambiable HPR

Avance y velocidad de corte

HPR130 | HPR230 | HPR180 | HPR280

Material de corte: HP423 | Entrada: MC1G

Grupo de arranque de virutas de Mapal*	Material	Rigidez/dureza [N/mm ²] [HRC]	Velocidad de corte v _c (m/min)				
			Refrigeración interna	Refrigeración exterior	MMS		
K	K1	K1.1	Hierro fundido con grafito laminar (fundición gris), GJL	< 300	140	100	120
		K2.1	Hierro fundido con grafito esferoidal, GJS	< 500	140	100	120
	K2	K2.2	Hierro fundido con grafito esferoidal, GJS	≤ 800			
		K2.3	Hierro fundido con grafito esferoidal, GJS	> 800			

HPR100 | HPR200 | HPR150 | HPR250

Material de corte: CP134 | Entrada: MC1G

Grupo de arranque de virutas de Mapal*	Material	Rigidez/dureza [N/mm ²] [HRC]	Velocidad de corte v _c (m/min)				
			Refrigeración interna	Refrigeración exterior	MMS		
K	K1	K1.1	Hierro fundido con grafito laminar (fundición gris), GJL	< 300	140	100	120
		K2.1	Hierro fundido con grafito esferoidal, GJS	< 500	140	100	120
	K2	K2.2	Hierro fundido con grafito esferoidal, GJS	≤ 800			
		K2.3	Hierro fundido con grafito esferoidal, GJS	> 800			

HPR130 | HPR180

Material de corte: HC419 | Entrada: MC1G

Grupo de arranque de virutas de Mapal*	Material	Rigidez/dureza [N/mm ²] [HRC]	Velocidad de corte v _c (m/min)				
			Refrigeración interna	Refrigeración exterior	MMS		
K	K1	K1.1	Hierro fundido con grafito laminar (fundición gris), GJL	< 300	120	100	120

HPR100 | HPR150

Material de corte: HC419 | Entrada: MC1G

Grupo de arranque de virutas de Mapal*	Material	Rigidez/dureza [N/mm ²] [HRC]	Velocidad de corte v _c (m/min)				
			Refrigeración interna	Refrigeración exterior	MMS		
K	K1	K1.1	Hierro fundido con grafito laminar (fundición gris), GJL	< 300	120	100	120

Avance f_z (mm/z) con diámetro de herramienta			
HPR130 HPR230		HPR180 HPR280	
z4	z6	z4	z6
7,000-9,590	9,600-18,590	7,000-14,590	14,600-21,290
0,150	0,200	0,150	0,200
0,150	0,200	0,150	0,200

Avance f_z (mm/z) con diámetro de herramienta			
HPR100 HPR200		HPR150 HPR250	
z6	z8	z6	z8
15,600-29,990	30,000-65,000	16,600-36,990	37,000-65,000
0,200	0,300	0,200	0,300
0,200	0,300	0,200	0,300

Avance f_z (mm/z) con diámetro de herramienta			
HPR130		HPR180	
z 4	z 6	z 4	z 6
7,000-9,590	9,600-18,590	7,000-14,590	14,600-21,290
0,150	0,200	0,150	0,200

Avance f_z (mm/z) con diámetro de herramienta			
HPR100		HPR150	
z6	z8	z6	z8
15,600-29,990	30,000-65,000	16,600-36,990	37,000-65,000
0,150	0,200	0,150	0,200

Los valores de corte indicados son de referencia.

Los datos óptimos para cada situación de mecanizado deben determinarse mediante ensayos o durante el propio proceso de mecanizado.

Recomendación de valores de corte para escariadores de cabezal intercambiable HPR

Avance y velocidad de corte

HPR130 | HPR230 | HPR180 | HPR280

Material de corte: HP421 | Entrada: MC1G

Grupo de arranque de virutas de Mapal*	Material	Rigidez/dureza [N/mm ²] [HRC]	Velocidad de corte v _c (m/min)			
			Refrigeración interna	Refrigeración exterior	MMS	
K2	K2.1	Hierro fundido con grafito esférico, GJS	< 500	120	100	120
	K2.2	Hierro fundido con grafito esférico, GJS	≤ 800			
	K2.3	Hierro fundido con grafito esférico, GJS	> 800			

HPR100 | HPR200 | HPR150 | HPR250

Material de corte: HP421 | Entrada: MC1G

Grupo de arranque de virutas de Mapal*	Material	Rigidez/dureza [N/mm ²] [HRC]	Velocidad de corte v _c (m/min)			
			Refrigeración interna	Refrigeración exterior	MMS	
K2	K2.1	Hierro fundido con grafito esférico, GJS	< 500	120	100	120
	K2.2	Hierro fundido con grafito esférico, GJS	≤ 800			
	K2.3	Hierro fundido con grafito esférico, GJS	> 800			

HPR130 | HPR230 | HPR180 | HPR280

Material de corte: HP423 | Entrada: MC1G

Grupo de arranque de virutas de Mapal*	Material	Rigidez/dureza [N/mm ²] [HRC]	Velocidad de corte v _c (m/min)			
			Refrigeración interna	Refrigeración exterior	MMS	
K2	K2.1	Hierro fundido con grafito esférico, GJS	< 500			
	K2.2	Hierro fundido con grafito esférico, GJS	≤ 800	120	100	120
	K2.3	Hierro fundido con grafito esférico, GJS	> 800	120	100	120
K3	K3.1	Hierro fundido con grafito vermicular, GJV; fundición maleable, GJM	< 500	90	70	90
	K3.2	Hierro fundido con grafito vermicular, GJV; fundición maleable, GJM	> 500	90	70	90

HPR100 | HPR200 | HPR150 | HPR250

Material de corte: HP423 | Entrada: MC1G

Grupo de arranque de virutas de Mapal*	Material	Rigidez/dureza [N/mm ²] [HRC]	Velocidad de corte v _c (m/min)			
			Refrigeración interna	Refrigeración exterior	MMS	
K2	K2.1	Hierro fundido con grafito esférico, GJS	< 500			
	K2.2	Hierro fundido con grafito esférico, GJS	≤ 800	120	100	120
	K2.3	Hierro fundido con grafito esférico, GJS	> 800	120	100	120
K3	K3.1	Hierro fundido con grafito vermicular, GJV; fundición maleable, GJM	< 500	90	70	90
	K3.2	Hierro fundido con grafito vermicular, GJV; fundición maleable, GJM	> 500	90	70	90

Avance f_z (mm/z) con diámetro de herramienta			
HPR130 HPR230		HPR180 HPR280	
z4	z6	z4	z6
7,000-9,590	9,600-18,590	7,000-14,590	14,600-21,290
0,150	0,200	0,150	0,200

Avance f_z (mm/z) con diámetro de herramienta			
HPR100 HPR200		HPR150 HPR250	
z6	z8	z6	z8
15,600-29,990	30,000-65,000	16,600-36,990	37,000-65,000
0,150	0,200	0,150	0,200

Avance f_z (mm/z) con diámetro de herramienta			
HPR130 HPR230		HPR180 HPR280	
z4	z6	z4	z6
7,000-9,590	9,600-18,590	7,000-14,590	14,600-21,290
0,150	0,200	0,150	0,200
0,150	0,200	0,150	0,200
0,150	0,200	0,150	0,200
0,150	0,200	0,150	0,200

Avance f_z (mm/z) con diámetro de herramienta			
HPR100 HPR200		HPR150 HPR250	
z6	z8	z6	z8
15,600-29,990	30,000-65,000	16,600-36,990	37,000-65,000
0,150	0,200	0,150	0,200
0,150	0,200	0,150	0,200
0,150	0,200	0,150	0,200
0,150	0,200	0,150	0,200

Los valores de corte indicados son de referencia.

Los datos óptimos para cada situación de mecanizado deben determinarse mediante ensayos o durante el propio proceso de mecanizado.

Recomendación de valores de corte para escariadores de cabezal intercambiable HPR

Avance y velocidad de corte

HPR130 | HPR230 | HPR180 | HPR280

Material de corte: PU620 | Entrada: MA0A

Grupo de arranque de virutas de Mapal*	Material	Rigidez/dureza [N/mm ²] [HRC]	Velocidad de corte v _c (m/min)			
			Refrigeración interna	Refrigeración exterior	MMS	
N	N1	N1.1 Aluminio, aleado y no aleado < 3 % Si	130	100	120	
		N1.2 Aluminio, aleado ≤ 7 % Si	130	100	120	
		N1.3 Aluminio, aleado > 7-12 % Si	130	100	120	
		N1.4 Aluminio, aleado > 12 % Si	130	100	120	
	N2	N2.1 Cobre, no aleado y de baja aleación	< 300	130	100	120
		N2.2 Cobre, aleado	> 300	130	100	120
		N2.3 Latón, bronce, fundición roja	< 1200	130	100	120

HPR100 | HPR200 | HPR150 | HPR250

Material de corte: PU620 | Entrada: MA0A

Grupo de arranque de virutas de Mapal*	Material	Rigidez/dureza [N/mm ²] [HRC]	Velocidad de corte v _c (m/min)			
			Refrigeración interna	Refrigeración exterior	MMS	
N	N1	N1.1 Aluminio, aleado y no aleado < 3 % Si	130	100	120	
		N1.2 Aluminio, aleado ≤ 7 % Si	130	100	120	
		N1.3 Aluminio, aleado > 7-12 % Si	130	100	120	
		N1.4 Aluminio, aleado > 12 % Si	130	100	120	
	N2	N2.1 Cobre, no aleado y de baja aleación	< 300	130	100	120
		N2.2 Cobre, aleado	> 300	130	100	120
		N2.3 Latón, bronce, fundición roja	< 1200	130	100	120

Avance f_z (mm/z) con diámetro de herramienta			
HPR130 HPR230		HPR180 HPR280	
z4	z6	z4	z6
7,000-9,590	9,600-18,590	7,000-14,590	14,600-21,290
0,150	0,250	0,150	0,250
0,150	0,250	0,150	0,250
0,150	0,250	0,150	0,250
0,150	0,250	0,150	0,250
0,150	0,250	0,150	0,250
0,150	0,250	0,150	0,250
0,150	0,250	0,150	0,250

Avance f_z (mm/z) con diámetro de herramienta			
HPR100 HPR200		HPR150 HPR250	
z6	z8	z6	z8
15,600-29,990	30,000-65,000	16,600-36,990	37,000-65,000
0,150	0,250	0,150	0,250
0,150	0,250	0,150	0,250
0,150	0,250	0,150	0,250
0,150	0,250	0,150	0,250
0,150	0,250	0,150	0,250
0,150	0,250	0,150	0,250
0,150	0,250	0,150	0,250

Los valores de corte indicados son de referencia.

Los datos óptimos para cada situación de mecanizado deben determinarse mediante ensayos o durante el propio proceso de mecanizado.

Recomendación de valores de corte para escariadores de cabezal intercambiable HPR

Avance y velocidad de corte

HPR180 | HPR280

Material de corte: HP625 | Entrada: MO2G

Grupo de arranque de virutas de Mapal*	Material	Rigidez/dureza [N/mm ²] [HRC]	Velocidad de corte v _c (m/min)			Avance f _z (mm/z) con diámetro de herramienta		
			Refrigeración interna	Refrigeración exterior	MMS	z 4	z 6	
						7,000-14,590	14,600-21,290	
S	S1.1	Titanio, aleaciones de titanio	< 400	35	20	25	0,060	0,080
	S2.1	Titanio, aleaciones de titanio	< 1200	35	20	25	0,060	0,080
	S2.2	Titanio, aleaciones de titanio	> 1200	35	20	25	0,060	0,080
	S3.1	Níquel, no aleado y aleado	< 900	30	15	25	0,060	0,080
	S3.2	Níquel, no aleado y aleado	> 900	30	15	25	0,060	0,080
	S4.1	Superaleación de gran resistencia al calor basada en Ni, Co y Fe		25	15	20	0,060	0,080
	S5.1	Aleaciones de wolframio y molibdeno		25	15	20	0,060	0,080

HPR131 | HPR231

Material de corte: HP625 | Entrada: MF1G

Grupo de arranque de virutas de Mapal*	Material	Rigidez/dureza [N/mm ²] [HRC]	Velocidad de corte v _c (m/min)			Avance f _z (mm/z) con diámetro de herramienta		
			Refrigeración interna	Refrigeración exterior	MMS	z 4	z 6	
						7,000-9,590	9,600-18,590	
S	S1.1	Titanio, aleaciones de titanio	< 400	35	20	25	0,060	0,100
	S2.1	Titanio, aleaciones de titanio	< 1200	35	20	25	0,060	0,100
	S2.2	Titanio, aleaciones de titanio	> 1200	35	20	25	0,060	0,100
	S3.1	Níquel, no aleado y aleado	< 900	30	15	25	0,060	0,100
	S3.2	Níquel, no aleado y aleado	> 900	30	15	25	0,060	0,100
	S4.1	Superaleación de gran resistencia al calor basada en Ni, Co y Fe		25	15	20	0,060	0,100
	S5.1	Aleaciones de wolframio y molibdeno		25	15	20	0,060	0,100

HPR110 | HPR210

Material de corte: HP625 | Entrada: MF1G

Grupo de arranque de virutas de Mapal*	Material	Rigidez/dureza [N/mm ²] [HRC]	Velocidad de corte v _c (m/min)			Avance f _z (mm/z) con diámetro de herramienta			
			Refrigeración interna	Refrigeración exterior	MMS	z 6	z 8		
						15,600-29,990	30,000-65,000		
S	S1.1	Titanio, aleaciones de titanio	< 400	35	20	25	0,100	0,100	
	S2	S2.1	Titanio, aleaciones de titanio	< 1200	35	20	25	0,100	0,100
		S2.2	Titanio, aleaciones de titanio	> 1200	35	20	25	0,100	0,100
	S3	S3.1	Níquel, no aleado y aleado	< 900	30	15	25	0,100	0,100
		S3.2	Níquel, no aleado y aleado	> 900	30	15	25	0,100	0,100
	S4	S4.1	Superalación de gran resistencia al calor basada en Ni, Co y Fe		25	15	20	0,100	0,100
	S5	S5.1	Aleaciones de wolframio y molibdeno		25	15	20	0,100	0,100

HPR150 | HPR250

Material de corte: HP625 | Entrada: MO2G

Grupo de arranque de virutas de Mapal*	Material	Rigidez/dureza [N/mm ²] [HRC]	Velocidad de corte v _c (m/min)			Avance f _z (mm/z) con diámetro de herramienta			
			Refrigeración interna	Refrigeración exterior	MMS	z 6	z 8		
						16,600-36,990	37,000-65,000		
S	S1.1	Titanio, aleaciones de titanio	< 400	35	20	25	0,080	0,080	
	S2	S2.1	Titanio, aleaciones de titanio	< 1200	35	20	25	0,080	0,080
		S2.2	Titanio, aleaciones de titanio	> 1200	35	20	25	0,080	0,080
	S3	S3.1	Níquel, no aleado y aleado	< 900	30	15	25	0,080	0,080
		S3.2	Níquel, no aleado y aleado	> 900	30	15	25	0,080	0,080
	S4	S4.1	Superalación de gran resistencia al calor basada en Ni, Co y Fe		25	15	20	0,080	0,080
	S5	S5.1	Aleaciones de wolframio y molibdeno		25	15	20	0,080	0,080

Los valores de corte indicados son de referencia.

Los datos óptimos para cada situación de mecanizado deben determinarse mediante ensayos o durante el propio proceso de mecanizado.

Cota a remover en el escariado

Grupo de arranque de virutas de Mapal*		Material	Rigidez/dureza [N/mm ²] [HRC]	
P	P1	P1.1 Aceros de construcción, para tornos automáticos, de cementación y revenidos, no aleados	< 700	
		P1.2 Aceros de construcción, para tornos automáticos, de cementación y revenidos, no aleados	< 1200	
	P2	P2.1 Aceros nitrurados, de cementación y aceros revenidos, aleados	< 900	
		P2.2 Aceros nitrurados, de cementación y aceros revenidos, aleados	< 1400	
	P3	P3.1 Aceros para herramientas, rodamientos, resortes y rápidos**	< 800	
		P3.2 Aceros para herramientas, rodamientos, resortes y rápidos**	< 1000	
		P3.3 Aceros para herramientas, rodamientos, resortes y rápidos**	< 1500	
	P4	P4.1 Aceros inoxidables, ferríticos y martensíticos		
	P5	P5.1 Fundición de acero		
	P6	P6.1 Fundición de acero inoxidable, ferrítica y martensítica		
M	M1	M1.1 Aceros inoxidables, austeníticos	< 700	
		M1.2 Aceros inoxidables, ferríticos/austeníticos (dúplex)	< 1000	
	M2	M2.1 Fundición de acero inoxidable, austenítica	< 700	
	M3	M3.1 Fundición de acero inoxidable, ferrítica/austenítica (dúplex)	< 1000	
K	K1	K1.1 Hierro fundido con grafito laminar (fundición gris), GJL	< 300	
		K2.1 Hierro fundido con grafito esferoidal, GJS	< 500	
		K2.2 Hierro fundido con grafito esferoidal, GJS	≤ 800	
	K2	K2.3 Hierro fundido con grafito esferoidal, GJS	> 800	
		K3	K3.1 Hierro fundido con grafito vermicular, GJV; fundición maleable, GJM	< 500
			K3.2 Hierro fundido con grafito vermicular, GJV; fundición maleable, GJM	> 500
N	N1	N1.1 Aluminio, aleado y no aleado < 3 % Si		
		N1.2 Aluminio, aleado ≤ 7 % Si		
		N1.3 Aluminio, aleado > 7-12 % Si		
		N1.4 Aluminio, aleado > 12 % Si		
	N2	N2.1 Cobre, no aleado y de baja aleación	< 300	
		N2.2 Cobre, aleado	> 300	
		N2.3 Latón, bronce, fundición roja	< 1200	
	N4	N4.1 Plástico, termoplásticos		
		N4.2 Plástico, plásticos termoestables		
		N4.3 Plástico, espumas		
C	C1	C1.1 Matriz de plástico, reforzada con fibras de aramida (AFK)		
		C1.2 Matriz de plástico (termoestable), CFK/GFK		
		C1.3 Matriz de plástico (termoplástico), CFK/GFK		
	C2	C2.1 Matriz de carbono, reforzada con fibras de carbono (CFC)		
S	S1	S1.1 Titanio, aleaciones de titanio	< 400	
		S2.1 Titanio, aleaciones de titanio	< 1200	
	S2	S2.2 Titanio, aleaciones de titanio	> 1200	
		S3	S3.1 Níquel, no aleado y aleado	< 900
	S3.2 Níquel, no aleado y aleado		> 900	
	S4	S4.1 Superaleación de gran resistencia al calor basada en Ni, Co y Fe		
S5	S5.1 Aleaciones de wolframio y molibdeno			
H	H1	H1.1 Acero templado/fundición de acero	< 44	
		H1.2 Acero templado/fundición de acero	< 55	
	H2	H2.1 Acero templado/fundición de acero	< 60	
		H2.2 Acero templado/fundición de acero	< 65	
		H2.3 Acero templado/fundición de acero	< 68	
	H3	H3.1 Fundición/fundición dura resistente al desgaste, GJN		

* Grupos de mecanizado MAPAL

** Si los componentes de aleación de Cr, Mo, Ni, V, W suman > 8 %, elegir el siguiente grupo de mecanizado MAPAL superior.

	Cota a remover a_p [mm] en el escariado				
	< Ø5 mm	Ø5-8 mm	Ø8-12 mm	Ø12-18 mm	> Ø18 mm
	0,100	0,100	0,150	0,150	0,150
	0,100	0,100	0,100	0,150	0,150
	0,100	0,100	0,150	0,150	0,150
	0,100	0,100	0,100	0,150	0,150
	0,100	0,100	0,150	0,150	0,150
	0,100	0,100	0,150	0,150	0,150
	0,100	0,100	0,100	0,150	0,150
	0,100	0,100	0,100	0,100	0,100
	0,100	0,100	0,100	0,150	0,150
	0,100	0,100	0,100	0,100	0,100
	0,100	0,100	0,100	0,100	0,100
	0,100	0,100	0,100	0,100	0,100
	0,100	0,100	0,100	0,100	0,100
	0,150	0,150	0,150	0,150	0,150
	0,150	0,150	0,150	0,150	0,150
	0,150	0,150	0,150	0,150	0,150
	0,100	0,150	0,150	0,150	0,150
	0,150	0,150	0,150	0,150	0,150
	0,100	0,150	0,150	0,150	0,150
	0,150	0,150	0,150	0,150	0,150
	0,150	0,150	0,150	0,150	0,150
	0,150	0,150	0,150	0,150	0,150
	0,150	0,150	0,150	0,150	0,150
	0,150	0,150	0,150	0,150	0,150
	0,200	0,200	0,200	0,200	0,200
	0,200	0,200	0,200	0,200	0,200
	0,200	0,200	0,200	0,200	0,200
	0,200	0,200	0,200	0,200	0,200
	0,200	0,200	0,200	0,200	0,200
	0,200	0,200	0,200	0,200	0,200
	0,100	0,100	0,100	0,100	0,100
	0,100	0,100	0,100	0,100	0,100
	0,100	0,100	0,100	0,100	0,100
	0,100	0,100	0,100	0,100	0,100
	0,100	0,100	0,100	0,100	0,100
	0,100	0,100	0,100	0,100	0,100
	0,100	0,100	0,100	0,100	0,100
	0,075	0,075	0,075	0,075	0,075
	0,050	0,050	0,075	0,075	0,075
	0,050	0,050	0,075	0,075	0,075
	0,050	0,050	0,075	0,075	0,075
	0,050	0,050	0,075	0,075	0,075
	0,100	0,050	0,075	0,075	0,075

Los valores de corte indicados son de referencia.

Los datos óptimos para cada situación de mecanizado deben determinarse mediante ensayos o durante el propio proceso de mecanizado.

Características detalladas de la herramienta, sistemas HFS



Sistema de sujeción axial HFS

También disponible para el módulo y las interfaces HSK



1 Diferentes variantes de portaherramientas
p. ej. mango cilíndrico, HSK-A

2 Cono para un centraje sencillo y altamente preciso

3 Cara plana de apoyo axial para rigidez y estabilidad

4 Conducción de refrigerante interior
Salida directa por el inserto

5 Tornillo de sujeción altamente resistente y preciso
con rosca diferencial



Sistema de sujeción radial HFS

Cambio de cabezal rápido, sencillo y fundamentalmente en la máquina



6 Perno excéntrico
para rápida sujeción y aflojamiento con elevada fuerza de arrastre

7 Cono para un centraje sencillo y altamente preciso

8 Cara plana de apoyo axial para rigidez y estabilidad

9 Conducción de refrigerante interior
Salida directa por el inserto

10 Tirante de precisión

11 Diferentes variantes de portaherramientas
p. ej. mango cilíndrico, HSK-A



Código de denominación

Portaherramientas para cabezal intercambiable CFS

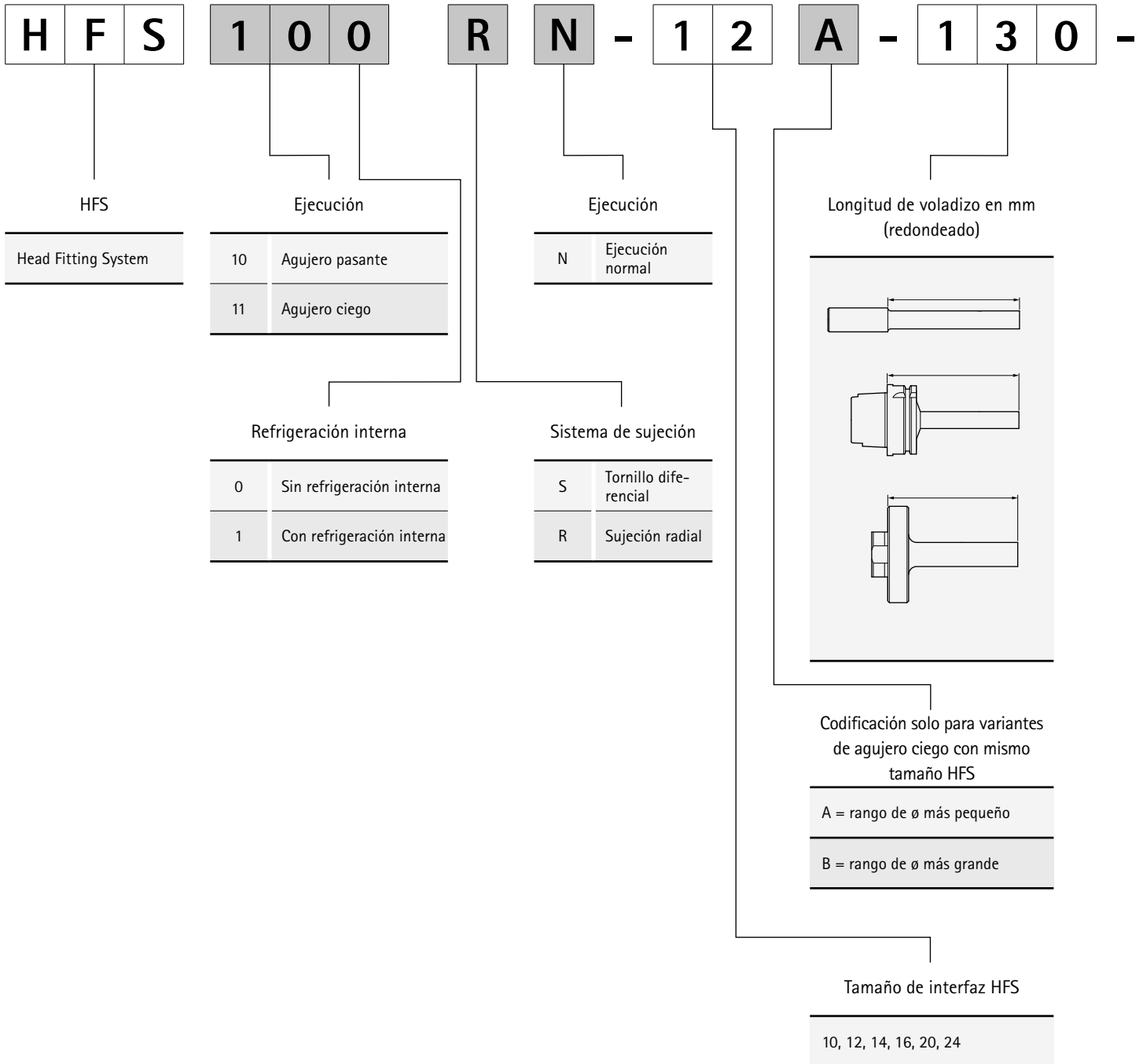

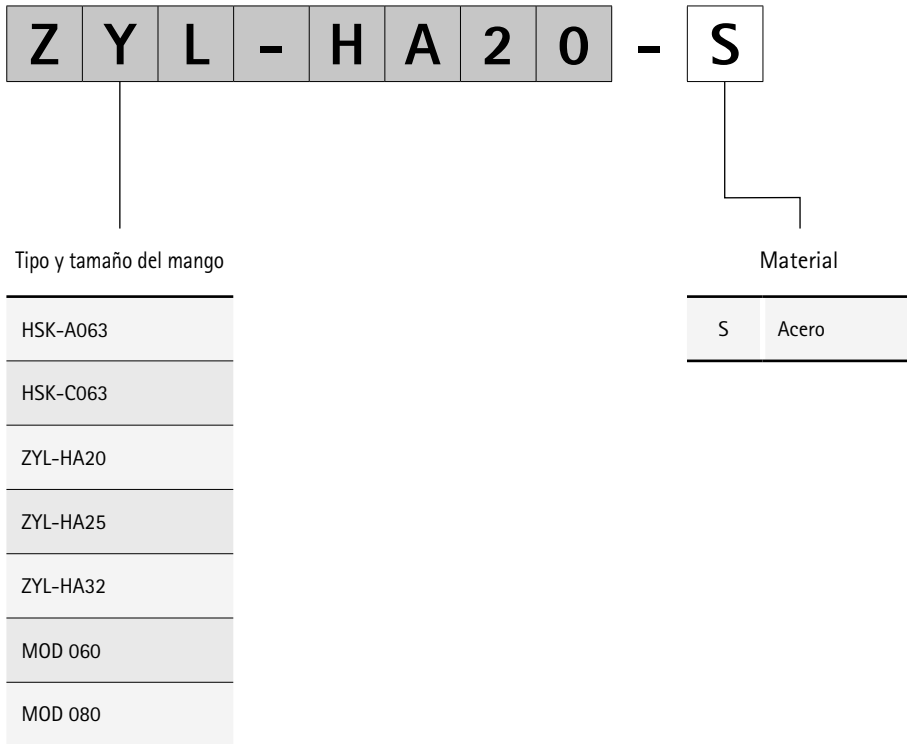

Portaherramientas para cabezal intercambiable CFS

Con sistema de sujeción axial

Mango según MN 623, similar a DIN 1835-A

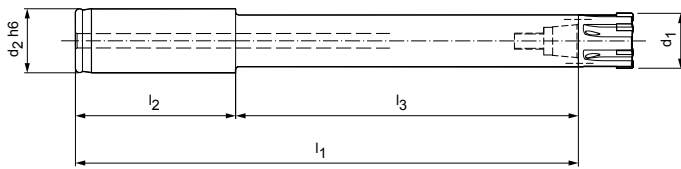

Ejecución larga con mango cilíndrico

Dimensiones						Especificación	Referencia
d ₁	Tamaño HFS	d ₂ h6	l ₁	l ₂	l ₃		
15,60 - 18,59	10	20	160	50	110	HFS101SN-10-110-ZYL-HA20-S	30010248
18,60 - 21,29	12	20	179,5	50	129,5	HFS101SN-12-130-ZYL-HA20-S	30010249
21,30 - 23,99	14	20	180,5	50	130,5	HFS101SN-14-131-ZYL-HA20-S	30010250
24,00 - 29,99	16	25	211	60	151	HFS101SN-16-151-ZYL-HA25-S	30010251
30,00 - 39,99	20	25	210	60	150	HFS101SN-20-150-ZYL-HA25-S	30010252
40,00 - 50,70	24	32	266	60	206	HFS101SN-24-206-ZYL-HA32-S	30010253
50,71 - 65,00							

Ejecución corta con mango cilíndrico

Dimensiones						Especificación	Referencia
d ₁	Tamaño HFS	d ₂ h6	l ₁	l ₂	l ₃		
15,60 - 18,59	10	20	99	50	49	HFS101SN-10-049-ZYL-HA20-S	30010256
18,60 - 21,29	12	20	118,5	50	68,5	HFS101SN-12-069-ZYL-HA20-S	30010257
21,30 - 23,99	14	20	119,5	50	69,5	HFS101SN-14-070-ZYL-HA20-S	30010258
24,00 - 29,99	16	25	150	60	90	HFS101SN-16-090-ZYL-HA25-S	30010259
30,00 - 39,99	20	25	149	60	89	HFS101SN-20-089-ZYL-HA25-S	30010260
40,00 - 50,70	24	32	167	60	107	HFS101SN-24-107-ZYL-HA32-S	30010261
50,71 - 65,00							

Ejecución extracorta con mango cilíndrico

Dimensiones						Especificación	Referencia
d ₁	Tamaño HFS	d ₂ h6	l ₁	l ₂	l ₃		
18,60 - 21,29	12	20	82	50	32	HFS101SN-12-032-ZYL-HA20-S	30078683

Medidas en mm.

Volumen de suministro: portaherramientas con tornillo diferencial y destornillador con mango en T.

Portaherramientas para cabezal intercambiable CFS

Con sistema de sujeción axial

Mango según MN 623, similar a DIN 1835-A

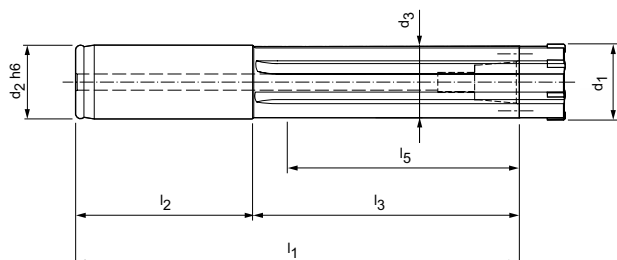

Ejecución larga con mango cilíndrico

Dimensiones								Especificación	Referencia
d ₁	Tamaño HFS	d ₂ h6	d ₃	l ₁	l ₂	l ₃	l ₅		
16,60 - 19,39	10	20	16	160	50	110	94	HFS111SN-10A-110-ZYL-HA20-S	30026380
19,40 - 21,29	10	20	18,6	160	50	110	94	HFS111SN-10B-110-ZYL-HA20-S	30026488
21,30 - 24,99	12	20	20,5	180,5	50	130,5	114,5	HFS111SN-12-131-ZYL-HA20-S	30026489
25,00 - 28,99	14	25	24,2	211,5	60	151,5	132,5	HFS111SN-14-152-ZYL-HA25-S	30026510
29,00 - 32,29	16	25	28,2	210	60	150	131	HFS111SN-16A-150-ZYL-HA25-S	30026511
32,30 - 36,99	16	25	31,5	210	60	150	140	HFS111SN-16B-150-ZYL-HA25-S	30026512
37,00 - 41,19	20	25	36,2	210	60	150	140	HFS111SN-20A-150-ZYL-HA25-S	30026513
41,20 - 44,99	20	25	40,2	210	60	150	140	HFS111SN-20B-150-ZYL-HA25-S	30026514
45,00 - 50,70	24	32	44	266	60	206	195	HFS111SN-24-206-ZYL-HA32-S	30026515
50,71 - 65,00									

Ejecución corta con mango cilíndrico

Dimensiones								Especificación	Referencia
d ₁	Tamaño HFS	d ₂ h6	d ₃	l ₁	l ₂	l ₃	l ₅		
16,60 - 19,39	10	20	16	99	50	49	33	HFS111SN-10A-049-ZYL-HA20-S	30026516
19,40 - 21,29	10	20	18,6	99	50	49	33	HFS111SN-10B-049-ZYL-HA20-S	30026521
21,30 - 24,99	12	20	20,5	117,5	50	67,5	51,5	HFS111SN-12-068-ZYL-HA20-S	30026522
25,00 - 28,99	14	25	24,2	150,5	60	90,5	71,5	HFS111SN-14-091-ZYL-HA25-S	30026523
29,00 - 32,29	16	25	28,2	149	60	89	70	HFS111SN-16A-089-ZYL-HA25-S	30026525
32,30 - 36,99	16	25	31,5	149	60	89	79	HFS111SN-16B-089-ZYL-HA25-S	30026526
37,00 - 41,19	20	25	36,2	149	60	89	79	HFS111SN-20A-089-ZYL-HA25-S	30026527
41,20 - 44,99	20	25	40,2	149	60	89	79	HFS111SN-20B-089-ZYL-HA25-S	30026528
45,00 - 50,70	24	32	44	167	60	107	96	HFS111SN-24-107-ZYL-HA32-S	30026529
50,71 - 65,00									

Medidas en mm.

Volumen de suministro: portaherramientas con tornillo diferencial y destornillador con mango en T.

Portaherramientas para cabezal intercambiable CFS

Con sistema de sujeción axial con alineación radial y alineación angular
Medidas del montaje del módulo según MN 5000-14

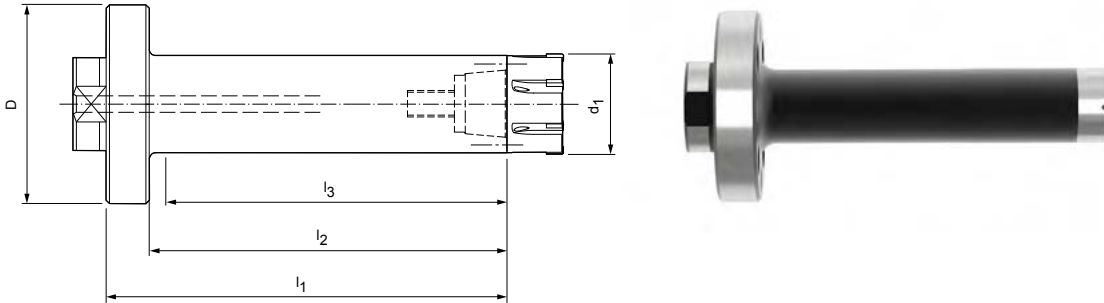

Ejecución larga con amarre del módulo (posibilidad de alineación radial y alineación angular)

Dimensiones						Especificación	Referencia
d ₁	Tamaño HFS	D	l ₁	l ₂	l ₃		
15,60 - 18,59	10	60	81	68	61	HFS101SN-10-081-MOD-060-S	30010264
18,60 - 21,29	12	60	100,5	87,5	80,5	HFS101SN-12-101-MOD-060-S	30010265
21,30 - 23,99	14	60	101,5	88,5	79,5	HFS101SN-14-102-MOD-060-S	30010266
24,00 - 29,99	16	60	122	109	104	HFS101SN-16-122-MOD-060-S	30010267
30,00 - 39,99	20	60	121	108	103	HFS101SN-20-121-MOD-060-S	30010268
40,00 - 50,70	24	60	133	120	116	HFS101SN-24-133-MOD-060-S	30010269
50,71 - 65,00	24	80	133	116	112	HFS101SN-24-133-MOD-080-S	30190195



Refacciones para amarre del módulo

Tamaño del módulo D	Tornillo de cabeza cilíndrica* ISO 4762 (DIN 912)			Opresor		Tornillo prisionero	
	cantidad requerida	Tamaño	Referencia	Tamaño	Referencia	Tamaño	Referencia
60	4	M5x16-12,9	10003601	10,6x5	10040108	M8x1x8	10040109
80	4	M6x20-12,9	10003619	10,6x5	10040108	M8x1x11,5	10075074

Medidas en mm.

Volumen de suministro: portaherramientas con tornillo diferencial, destornillador con mango en T, tornillos de fijación para amarre del módulo y piezas para la alineación angular del amarre del módulo.

Portaherramientas para cabezal intercambiable CFS

Con sistema de sujeción axial con alineación radial y alineación angular
Medidas del montaje del módulo según MN 5000-14

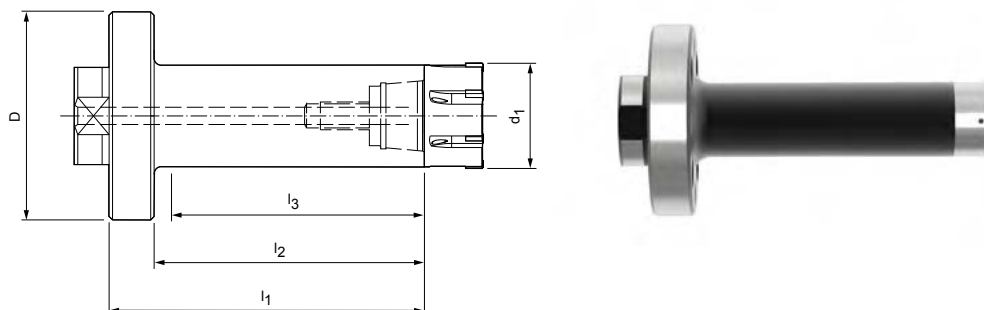

Ejecución corta con amarre del módulo (posibilidad de alineación radial y alineación angular)

Dimensiones						Especificación	Referencia
d ₁	Tamaño HFS	D	l ₁	l ₂	l ₃		
15,60 - 18,59	10	60	49	36	31	HFS101SN-10-049-MOD-060-S	30027896
18,60 - 21,29	12	60	58,5	45,5	40,5	HFS101SN-12-059-MOD-060-S	30027897
21,30 - 23,99	14	60	62,5	49,5	44,5	HFS101SN-14-063-MOD-060-S	30027898
24,00 - 29,99	16	60	72	59	54	HFS101SN-16-072-MOD-060-S	30027899
30,00 - 39,99	20	60	71	58	53	HFS101SN-20-071-MOD-060-S	30027900
40,00 - 50,70	24	60	84	71	66	HFS101SN-24-084-MOD-060-S	30027901
50,71 - 65,00	24	80	84	67	62	HFS101SN-24-084-MOD-080-S	30152510

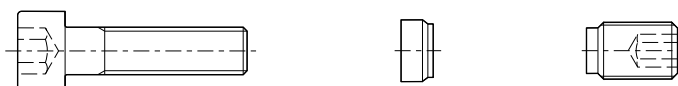

Refacciones para amarre del módulo

Tamaño del módulo D	Tornillo de cabeza cilíndrica* ISO 4762 (DIN 912)			Opresor		Tornillo prisionero	
	cantidad requerida	Tamaño	Referencia	Tamaño	Referencia	Tamaño	Referencia
60	4	M5x16-12,9	10003601	10,6x5	10040108	M8x1x8	10040109
80	4	M6x20-12,9	10003619	10,6x5	10040108	M8x1x11,5	10075074

Medidas en mm.

Volumen de suministro: portaherramientas con tornillo diferencial, destornillador con mango en T, tornillos de fijación para amarre del módulo y piezas para la alineación angular del amarre del módulo.

Portaherramientas para cabezal intercambiable CFS

Con sistema de sujeción axial con alineación radial y alineación angular
Medidas del montaje del módulo según MN 5000-14

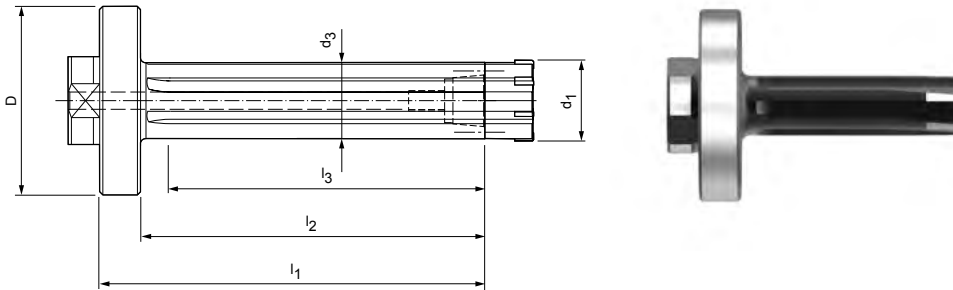

Ejecución larga con amarre del módulo (posibilidad de alineación radial y alineación angular)

Dimensiones							Especificación	Referencia
d ₁	Tamaño HFS	D	d ₃	l ₁	l ₂	l ₃		
16,60 - 19,39	10	60	16	81	68	48	HFS111SN-10A-081-MOD-060-S	30026562
19,40 - 21,29	10	60	18,6	81	68	48	HFS111SN-10B-081-MOD-060-S	30026563
21,30 - 24,99	12	60	20,5	101,5	88,5	69,5	HFS111SN-12-102-MOD-060-S	30026564
25,00 - 28,99	14	60	24,2	122,5	109,5	90,5	HFS111SN-14-123-MOD-060-S	30026565
29,00 - 32,29	16	60	28,2	121	108	89	HFS111SN-16A-121-MOD-060-S	30026566
32,30 - 36,99	16	60	31,5	121	108	89	HFS111SN-16B-121-MOD-060-S	30026567
37,00 - 41,19	20	60	36,2	121	108	89	HFS111SN-20A-121-MOD-060-S	30026568
41,20 - 44,99	20	60	40,2	121	108	89	HFS111SN-20B-121-MOD-060-S	30026569
45,00 - 50,70	24	60	44	123	110	95	HFS111SN-24-123-MOD-060-S	30026570
50,71 - 65,00	24	80	44	133	116	110	HFS111SN-24-133-MOD-080-S	30193167



Refacciones para amarre del módulo

Tamaño del módulo D	Tornillo de cabeza cilíndrica* ISO 4762 (DIN 912)			Opresor		Tornillo prisionero	
	cantidad requerida	Tamaño	Referencia	Tamaño	Referencia	Tamaño	Referencia
60	4	M5x16-12,9	10003601	10,6x5	10040108	M8x1x8	10040109
80	4	M6x20-12,9	10003619	10,6x5	10040108	M8x1x11,5	10075074

Medidas en mm.

Volumen de suministro: portaherramientas con tornillo diferencial, destornillador con mango en T, tornillos de fijación para amarre del módulo y piezas para la alineación angular del amarre del módulo.

Portaherramientas para cabezal intercambiable CFS

Con sistema de sujeción axial con alineación radial y alineación angular
Medidas del montaje del módulo según MN 5000-14

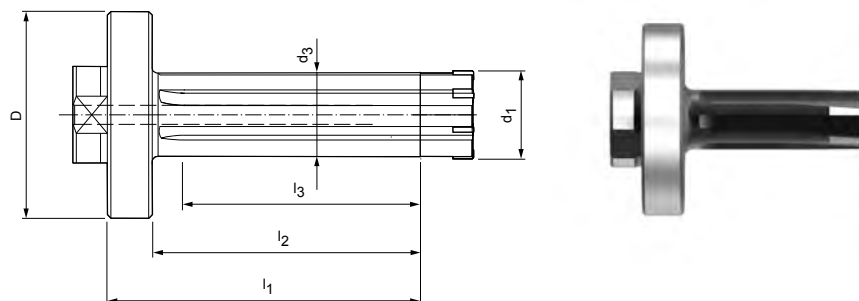

Ejecución corta con amarre del módulo (posibilidad de alineación radial y alineación angular)

Dimensiones							Especificación	Referencia
d ₁	Tamaño HFS	D	d ₃	l ₁	l ₂	l ₃		
16,60 - 19,39	10	60	16	49	36	31	HFS111SN-10A-049-MOD-060-S	30027885
19,40 - 21,29	10	60	18,6	59	46	41	HFS111SN-10B-059-MOD-060-S	30027886
21,30 - 24,99	12	60	20,5	62,5	49,5	44,5	HFS111SN-12-063-MOD-060-S	30027887
25,00 - 28,99	14	60	24,2	72,5	59,5	54,5	HFS111SN-14-073-MOD-060-S	30027888
29,00 - 32,29	16	60	28,2	71	58	53	HFS111SN-16A-071-MOD-060-S	30027889
32,30 - 36,99	16	60	31,5	71	58	53	HFS111SN-16B-071-MOD-060-S	30027890
37,00 - 41,19	20	60	36,2	71	58	53	HFS111SN-20A-071-MOD-060-S	30027891
41,20 - 44,99	20	60	40,2	81	68	63	HFS111SN-20B-081-MOD-060-S	30027892
45,00 - 50,70	24	60	44	84	71	66	HFS111SN-24-084-MOD-060-S	30027893
50,71 - 65,00	24	80	44	84	67	64	HFS111SN-24-084-MOD-080-S	30193168



Refacciones para amarre del módulo

Tamaño del módulo D	Tornillo de cabeza cilíndrica* ISO 4762 (DIN 912)			Opresor		Tornillo prisionero	
	cantidad requerida	Tamaño	Referencia	Tamaño	Referencia	Tamaño	Referencia
60	4	M5x16-12,9	10003601	10,6x5	10040108	M8x1x8	10040109
80	4	M6x20-12,9	10003619	10,6x5	10040108	M8x1x11,5	10075074

Medidas en mm.

Volumen de suministro: portaherramientas con tornillo diferencial, destornillador con mango en T, tornillos de fijación para amarre del módulo y piezas para la alineación angular del amarre del módulo.

Portaherramientas para cabezal intercambiable CFS

Con sistema de sujeción axial

Mango HSK-A según DIN 69893-1

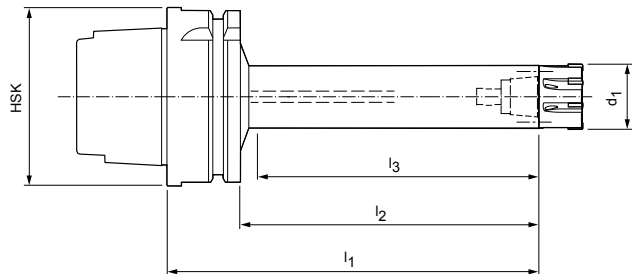

Ejecución larga con HSK-A 63

Dimensiones						Especificación	Referencia
d_1	Tamaño HFS	l_1	l_2	l_3	Tamaño HSK-A		
15,60 - 18,59	10	117	91	86	63	HFS101SN-10-117-HSK-A063-S	30010272
18,60 - 21,29	12	132,5	106,5	100,5	63	HFS101SN-12-133-HSK-A063-S	30010273
21,30 - 23,99	14	131,5	105,5	99,5	63	HFS101SN-14-132-HSK-A063-S	30010275
24,00 - 29,99	16	163	137	129	63	HFS101SN-16-163-HSK-A063-S	30010276
30,00 - 39,99	20	188	162	158	63	HFS101SN-20-188-HSK-A063-S	30010280
40,00 - 50,70	24	207	181	176	63	HFS101SN-24-207-HSK-A063-S	30010286
50,71 - 65,00							

Ejecución corta con HSK-A 63

Dimensiones						Especificación	Referencia
d_1	Tamaño HFS	l_1	l_2	l_3	Tamaño HSK-A		
15,60 - 18,59	10	77	51	46	63	HFS101SN-10-077-HSK-A063-S	30010283
18,60 - 21,29	12	92,5	66,5	60,5	63	HFS101SN-12-093-HSK-A063-S	30010285
21,30 - 23,99	14	91,5	65,5	59,5	63	HFS101SN-14-092-HSK-A063-S	30010287
24,00 - 29,99	16	112	86	79	63	HFS101SN-16-112-HSK-A063-S	30010288
30,00 - 39,99	20	111	85	78	63	HFS101SN-20-111-HSK-A063-S	30010289
40,00 - 50,70	24	109	83	76	63	HFS101SN-24-109-HSK-A063-S	30010291
50,71 - 65,00							

Medidas en mm.

Volumen de suministro: portaherramientas con tornillo diferencial y destornillador con mango en T.

Portaherramientas para cabezal intercambiable CFS

Con sistema de sujeción axial
Mango HSK-A según DIN 69893-1

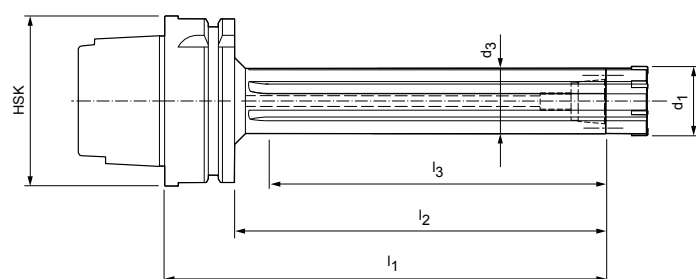

Ejecución larga con HSK-A 63

Dimensiones							Especificación	Referencia
d ₁	Tamaño HFS	d ₃	l ₁	l ₂	l ₃	Tamaño HSK-A		
16,60 - 19,39	10	16,0	117	91	71	63	HFS111SN-10A-117-HSK-A063-S	30026586
19,40 - 21,29	10	18,6	117	91	71	63	HFS111SN-10B-117-HSK-A063-S	30026587
21,30 - 24,99	12	20,5	131,5	105,5	86,5	63	HFS111SN-12-132-HSK-A063-S	30026588
25,00 - 28,99	14	24,2	163,5	137,5	118,5	63	HFS111SN-14-164-HSK-A063-S	30026589
29,00 - 32,29	16	28,2	188	162	143	63	HFS111SN-16A-188-HSK-A063-S	30026590
32,30 - 36,99	16	31,5	188	162	143	63	HFS111SN-16B-188-HSK-A063-S	30026591
37,00 - 41,19	20	36,2	188	162	152	63	HFS111SN-20A-188-HSK-A063-S	30026592
41,20 - 44,99	20	40,2	188	162	152	63	HFS111SN-20B-188-HSK-A063-S	30026593
45,00 - 50,70	24	44,0	233	207	197	63	HFS111SN-24-233-HSK-A063-S	30026594
50,71 - 65,00								

Ejecución corta con HSK-A 63

Dimensiones							Especificación	Referencia
d ₁	Tamaño HFS	d ₃	l ₁	l ₂	l ₃	Tamaño HSK-A		
16,60 - 19,39	10	16,0	77	51	31	63	HFS111SN-10A-077-HSK-A063-S	30026574
19,40 - 21,29	10	18,6	77	51	31	63	HFS111SN-10B-077-HSK-A063-S	30026575
21,30 - 24,99	12	20,5	91,5	65,5	46,5	63	HFS111SN-12-092-HSK-A063-S	30026576
25,00 - 28,99	14	24,2	112,5	86,5	67,5	63	HFS111SN-14-113-HSK-A063-S	30026577
29,00 - 32,29	16	28,2	111	85	66	63	HFS111SN-16A-111-HSK-A063-S	30026578
32,30 - 36,99	16	31,5	111	85	66	63	HFS111SN-16B-111-HSK-A063-S	30026579
37,00 - 41,19	20	36,2	111	85	75	63	HFS111SN-20A-111-HSK-A063-S	30026580
41,20 - 44,99	20	40,2	111	85	75	63	HFS111SN-20B-111-HSK-A063-S	30026581
45,00 - 50,70	24	44,0	109	83	73	63	HFS111SN-24-109-HSK-A063-S	30026582
50,71 - 65,00								

Medidas en mm.

Volumen de suministro: portaherramientas con tornillo diferencial y destornillador con mango en T.

Portaherramientas para cabezal intercambiable CFS

Con sistema de sujeción radial, mango según MN 623, similar a DIN 1835-A
Para escariador de cabezal intercambiable HPR100, HPR110, HPR200, HPR210

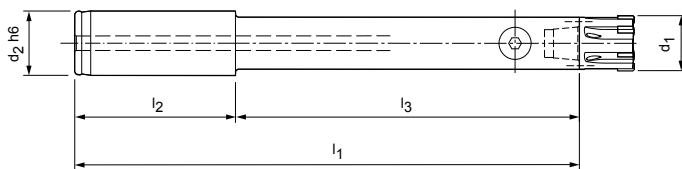

Ejecución larga con mango cilíndrico

Dimensiones						Especificación	Referencia
d ₁	Tamaño HFS	d ₂ h6	l ₁	l ₂	l ₃		
18,60 - 21,29	12	20	179,5	50	129,5	HFS101RN-12-130-ZYL-HA20-S	30078110
21,30 - 23,99	14	20	180,5	50	130,5	HFS101RN-14-131-ZYL-HA20-S	30078115
24,00 - 29,99	16	25	211	60	151	HFS101RN-16-151-ZYL-HA25-S	30078116
30,00 - 39,99	20	25	210	60	150	HFS101RN-20-150-ZYL-HA25-S	30080112

Ejecución corta con mango cilíndrico

Dimensiones						Especificación	Referencia
d ₁	Tamaño HFS	d ₂ h6	l ₁	l ₂	l ₃		
18,60 - 21,29	12	20	118,5	50	68,5	HFS101RN-12-069-ZYL-HA20-S	30078117
21,30 - 23,99	14	20	119,5	50	69,5	HFS101RN-14-070-ZYL-HA20-S	30078118
24,00 - 29,99	16	25	150	60	90	HFS101RN-16-090-ZYL-HA25-S	30078119
30,00 - 39,99	20	25	149	60	89	HFS101RN-20-089-ZYL-HA25-S	30080151

Ejecución extracorta con mango cilíndrico

Dimensiones						Especificación	Referencia
d ₁	Tamaño HFS	d ₂ h6	l ₁	l ₂	l ₃		
18,60 - 21,29	12	20	85	50	35	HFS101RN-12-035-ZYL-HA20-S	30115560

Medidas en mm.

Recomendación: Para facilitar un cambio rápido de los escariadores con el sistema de sujeción radial, debería pedirse al menos un tirante adicional.

Volumen de suministro: Portaherramientas con tirante, destornillador con mango en T y llave de boca para tirante.



Accesorios y refacciones para HFS



Tornillo diferencial para sistema de sujeción axial

Tamaño HFS	sin paso del refrigerante Tornillo diferencial MN 618 Referencia	con paso del refrigerante Tornillo diferencial MN 618 Referencia
10	10024720	10025194
12	10024721	10025195
14	10024721	10025195
16	10024722	10025196
20	10024722	10025196
24	10024723	10025198



Tirante para sistema de sujeción radial

Tamaño HFS	sin agujero para refrigerante Referencia	con agujero para refrigerante Referencia
12	10059113	10059273
14	10059113	10059273
16	10059117	10059279
20	10059117	10059279

Recomendación: Para facilitar un cambio rápido de los escariadores con el sistema de sujeción radial, debería pedirse al menos un tirante adicional.

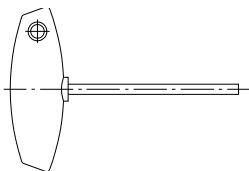

Destornillador con mango en T

Tamaño HFS	ejecución corta		ejecución larga	
	Tamaño	Referencia	Tamaño	Referencia
10	sw2,5 x 100	10006233	sw2,5 x 200	10032722
12	sw3 x 100	10006234	sw3 x 200	10025313
14	sw3 x 100	10006234	sw3 x 200	10025313
16	sw4 x 100	10006235	sw4 x 200	10018010
20	sw4 x 100	10006235	sw4 x 200	10018010
24	sw5 x 100	10006236	sw5 x 200	10013349

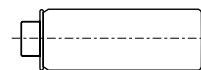

Limpiador cónico para cono interior HFS

Tamaño HFS	Referencia
10	10029989
12	10029990
14	10030002
16	10030003
20	10030004
24	10030005

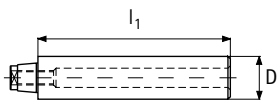

Mandriles de comprobación (ayuda de alineación)

Tamaño HFS	l_1	D	Referencia
10	70	15	30036468
12	80	20	30036469
14	80	20,5	30036470
16	80	23,2	30036471
20	80	29,3	30036472
24	80	39	30036473

Medidas en mm.

Ejecución: Defecto de concentricidad admisible de la parte cilíndrica respecto a la interfaz HFS = 0,002 mm.

Accesorios y refacciones para HSK-A 63

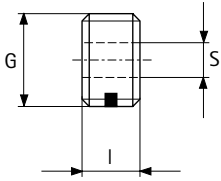

Tornillo ciego

Tamaño HSK-A	I	S	G	Referencia
63	11,5	8	M18x1	30326078

Tamaño HFS	Ancho de llave	Llave dinamométrica				Hojas y puntas hexagonales para llave dinamométrica			
		Par de giro	Ejecución	Accionamiento	Referencia	l [mm]	l ₁ [mm]	Accionamiento	Referencia
10	2.5	4 Nm	fija – con hoja	–	10044842	175	70	Hoja	10044839
12	3	6 Nm	ajustable – sin punta	1/4"	10040125	55	30	Punta 1/4"	10040122
14	3	6 Nm	ajustable – sin punta	1/4"	10040125	55	30	Punta 1/4"	10040122
16	4	15 Nm	ajustable – sin punta	3/8"	10040126	60	35	Punta 3/8"	10040123
20	4	15 Nm	ajustable – sin punta	3/8"	10040126	60	35	Punta 3/8"	10040123
24	5	20 Nm	ajustable – sin punta	3/8"	10040126	70	45	Punta 3/8"	10040124

Llave dinamométrica y puntas hexagonales solo a partir de tamaño HFS 12 o ancho de llave 3.

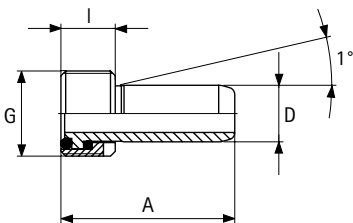

Tubo de refrigerante

Tamaño HSK-A	A	I	G	D	Referencia
63	36.6	11,5	M18x1	12	30326006

Volumen de suministro: tubo de refrigerante con dos juntas tóricas y tuerca de unión.
Ejecución: movilidad angular suave de 1°, con autocentrado y sellado axial.
Nota: Ejecución de conformidad con DIN 69893.

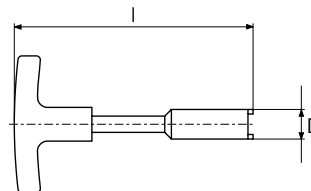

Llave de montaje

Tamaño HSK-A	I	D	Referencia
63	182	17	10040110

Utilización: Para el montaje y desmontaje de tubos de refrigerante.

Medidas en mm.

Utilización: para cerrar el agujero roscado en mangos de herramienta HSK, si no se utiliza ningún tubo de refrigerante.

Ejecución: con inserto de Nylok para fijar el tornillo.

Material: acero inoxidable.



HERRAMIENTAS CON GUÍAS DE APOYO

Herramientas con guías de apoyo

Vista general de la selección Escariadores de un filo _____	478
Código de denominación _____	480

Escariadores de un filo WP

MN2000 _____	484
MN2003 _____	486
MN2004 _____	488
MN2034 _____	489
MN2023 _____	490
MN2024 _____	491
MN2043 _____	492
MN2044 _____	493
Plaquitas reversibles, entradas AS AZ DZ EK SZ _____	494
Recomendación de valores de corte _____	504

Sistema EasyAdjust

Vista general de los productos, manejo y vista general del sistema ..	514
Estrechamiento del filo _____	516
Vista general de la selección _____	517
Insertos reversibles HX para sistema EA _____	518
Insertos reversibles TEC para sistema EA _____	520
Accesorios _____	522
Recomendación de valores de corte _____	524

Herramientas de mecanizado exterior







Vista general de los productos, manejo y vista general del sistema ..	538
Insertos de corte TEC _____	540
Insertos de corte _____	542
Accesorios _____	544
Recomendación de valores de corte _____	546

Anexo técnico

Indicaciones de manipulación _____	737
------------------------------------	-----

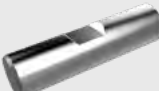

Vista general de la selección | Escariadores de un filo

Concepto de máquina		Tipo de suministro de refrigerante		Tipo de agujero		Número de insertos	Forma del mango
							
Escariadores de un filo	Taladradoras		✓	✓		1	 Mango cono Morse
Escariadores de un filo	Tornos automáticos (con portaherramientas flotante)	✓		✓		1	 Mango cilíndrico con plano de sujeción NC
		✓			✓	1	
		✓			✓	1	
Escariadores de un filo	Centros de mecanizado	✓		✓		1	 Mango cilíndrico con plano de sujeción NC
		✓			✓	1	
		✓		✓		1	 Mango cilíndrico liso
		✓			✓	1	

Entradas para insertos de corte MAPAL

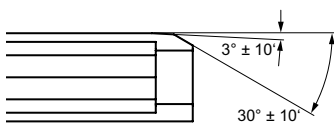

Entrada AS

Entrada adecuada para todos los materiales, alta calidad de superficie incluso a velocidades de corte elevadas. Longitud de entrada de 1,3 mm.

Profundidad de corte máx.: 0,25 mm
 Ángulo de desprendimiento: 0°, 6°, 12°

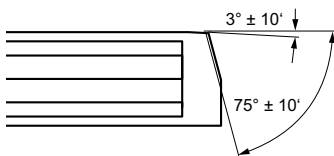

Entrada AZ

Para unas velocidades de corte elevadas; especialmente adecuada para el mecanizado de aluminio.



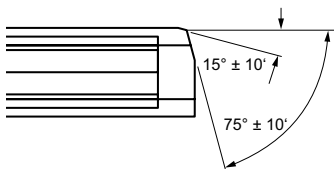







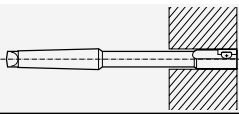

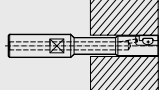

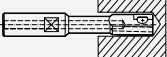

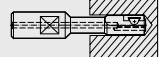
Profundidad de corte máx.: 0,5 mm
 Ángulo de desprendimiento: 0°, 6°, 12°

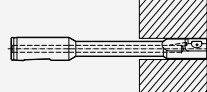

Entrada DZ

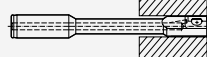
Especialmente para materiales de viruta corta (GG) y grandes profundidades de corte. El ángulo de entrada de 15° del inserto acabador aumenta ligeramente las fuerzas radiales, por lo que también es adecuado para piezas de pared fina.

Profundidad de corte máx.: 0,15 mm
 Ángulo de desprendimiento: 0°, 6°, 12°

Herramienta	Inserto		Página	Serie
Serie	Denominación			
MN2000	Escariador WP 		484	MN2000 Ejecución con mango MK 
MN2003	Escariador WP 		486	MN2003 Ejecución corta con refrigeración interna 
MN2004			488	MN2004 Ejecución corta 
MN2034 (forma corta)			489	MN2034 Ejecución extracorta 
MN2023	Escariador NC WP 		490	MN2023 Forma constructiva NC 
MN2024			491	MN2024 Forma constructiva NC 
MN2043			492	MN2043 Forma constructiva NC 
MN2044			493	MN2044 Forma constructiva NC 

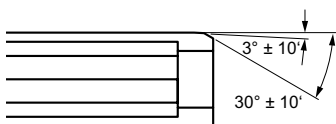

Entrada EK

Utilizar únicamente cuando se requiere una longitud de entrada reducida de 0,6 mm, para todos los materiales, no sobrepasar un avance máx. de 0,2 mm/vuelta.

Profundidad de corte máx.: 0,15 mm
Ángulo de desprendimiento: 0°, 6°, 12°

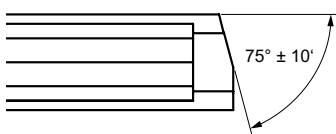

Entrada SZ

Especialmente para aleaciones de fundición de aluminio, buena superficie con avances reducidos. Las dimensiones de las ranuras se respetan con precisión. El ángulo de entrada de 75° del inserto principal reduce las fuerzas radiales, por lo que también es adecuado para piezas de pared fina.

Profundidad de corte máx.: 1,0 mm
Ángulo de desprendimiento: 6°, 12°

Código de denominación

Escariador WP

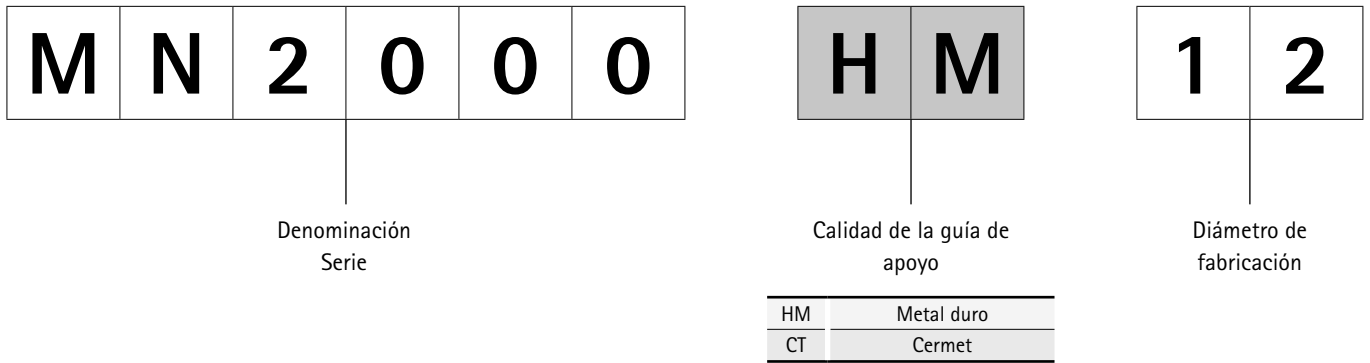

Sistema EasyAdjust

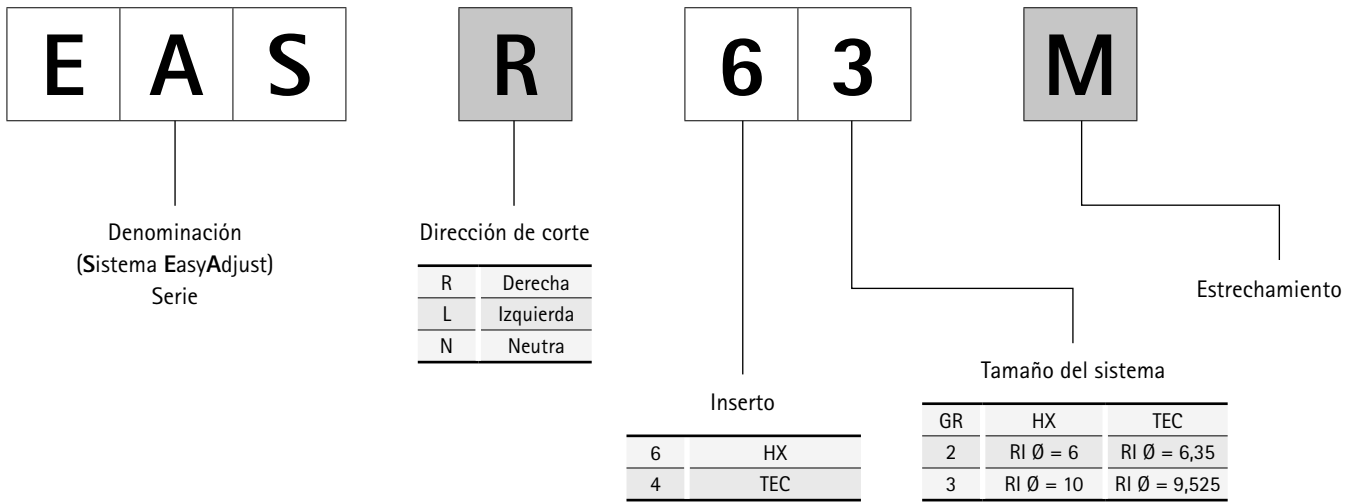

H	7
----------	----------

Tolerancia IT o
diferencias de
medida

A	S
----------	----------

Designación de
entrada

AS	
AZ	Para información acerca de la apli- cación, véanse las páginas 478/479
DZ	
EK	
SZ	

Código de denominación

Insertos de corte



Tamaño
81 | 90 | 91 | 92 | 93
Seleccionar el tamaño adecuado a la ejecución del escariador. Para la asignación, véanse las tablas de productos.

Indicar solo en ejecuciones con bisel F.

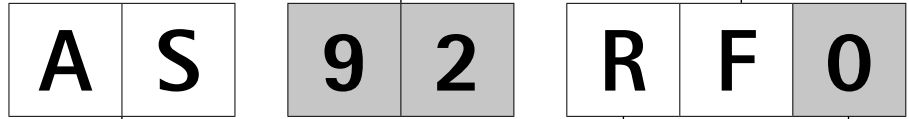

Forma de entrada
AS = 3°/30° Longitud 1,3 mm
AZ = 3°/75° Longitud 1,3 mm
DZ = 15°/75° Longitud 0,55 mm
EK = 3°/30° Longitud 0,6 mm
SZ = 0°/75° Longitud 0,55 mm

Sentido de corte
R = inserto a la derecha
L = inserto a la izquierda

Tamaño del ángulo de desprendimiento
0 = 0°
6 = 6°
2 = 12°

Insertos de corte HX



Entrada
8 = R 0,8

Forma hexagonal
Hexagonal

Geometría de forma de viruta y (ángulo de desprendimiento)
1 = Muy positivo
2 = Positivo

Tamaño de los insertos de corte
2 = Circunferencia inscrita \varnothing 6 mm
3 = Circunferencia inscrita \varnothing 10 mm

Insertos de corte TEC

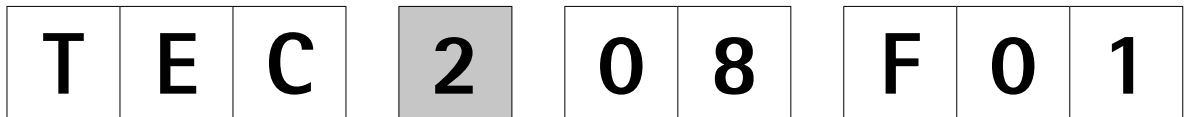

Forma de plaquita (tetragonal)

Tamaño de los insertos de corte
2 = \varnothing de circunferencia inscrita: 6,35
3 = \varnothing de circunferencia inscrita: 9,525

Forma de entrada
04 = R = 0,4
08 = R = 0,8
AS = 3°/30°/ Longitud 1,3
EK = 3°/30°/ Longitud 0,6
DZ = 15°/75°/ Longitud 0,55

Diseño de filo de inserto
F01 = De aristas afiladas
E02 = Redondeado
S35 = Bisel negativo y redondeado

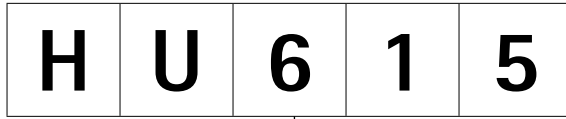

Calidad del material de corte
p. ej.: HU = metal duro, sin recubrimiento



Sentido de corte
RL = Inserto a la derecha e izquierda



Calidad del material de corte
p. ej.: HU = metal duro, sin recubrimiento

Opcionalmente:
Bisel F

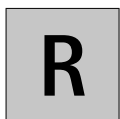

Dirección de corte
R = inserto a la derecha
L = inserto a la izquierda
N = Inserto a la derecha e izquierda (neutro)

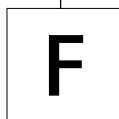

Escalón de forma de viruta
1.ª pos. (almacén)
0 = Sin característica
1 = Paralelo positivo



Escalón de forma de viruta 2.ª posición (ángulo de desprendimiento)
O = 0° N = 12°
G = 6° U = 18°
J = 8°

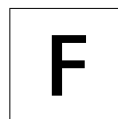

Solo con insertos equipados
F = Toda la superficie de desprendimiento en un lado (bisel completo)



Calidad del material de corte (ejemplo)



Escariador de un filo WP MN2000

Ejecución con mango MK

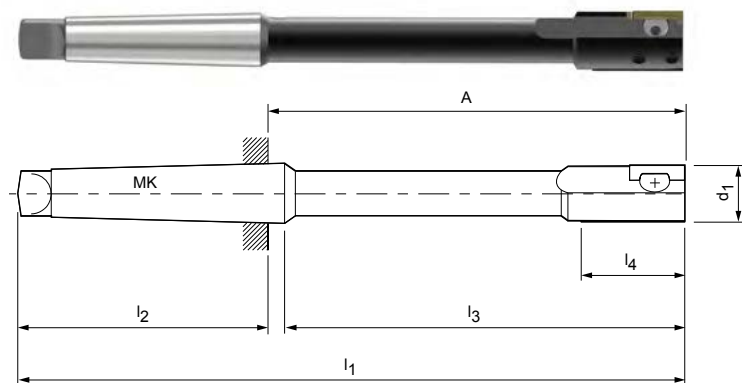

Dimensiones							Tamaño de los insertos de corte	Accesorios				
d ₁ *	l ₁	l ₂	l ₃	l ₄	MK	A		Sujeción		Ajuste		
								Tornillo TORX®/tornillo diferencial	Plaquita de sujeción	Tornillo prisionero MN 620	Cuña de ajuste MN 619	
								Referencia (tamaño)				
5,00 - 5,29	126**	62	60,5	15	1	64	(SP) 81	Tornillo Torx	10036776 (M1,6x3,9)	30026285 (GR - 1YN)	10036736 (M2x1,8)	30026239 (GR - 06)
5,30 - 5,49	126**	62	60,5	15	1	64	(SP) 81		10036778 (M1,6x4,4)	30026285 (GR - 1YN)	10036737 (M2x2)	30026239 (GR - 06)
5,50 - 6,19	126**	62	60,5	15	1	64	(SP) 81		10036780 (M2x4)	30026286 (GR - 1X)	10036737 (M2x2)	30026260 (GR - 07)
6,20 - 6,90	126**	62	60,5	15	1	64	(SP) 81		10036781 (M2x5)	30026286 (GR - 1X)	10036738 (M2x2,5)	30026260 (GR - 07)
6,91 - 7,49	136**	62	70,5	15	1	74	90		10036783 (M2,5x4,8)	30026287 (GR - 1W)	10036730 (M2,5x2,2)	30026261 (GR - 08)
7,50 - 7,79	136**	62	70,5	15	1	74	90		10036784 (M2,5x5,2)	30026287 (GR - 1W)	10036731 (M2,5x2,5)	30026262 (GR - 09)
7,80 - 7,99	155	62	89,5	30	1	93	90		10036711 (M3LH/RHx5)	30026288 (GR - 0F)	10036743 (M3x2,5)	30026238 (GR - 0)
8,00 - 8,79	155	62	89,5	30	1	93	90		10036711 (M3LH/RHx5)	30026288 (GR - 0F)	10036743 (M3x2,5)	30026238 (GR - 0)
8,80 - 9,29	160	62	94,5	30	1	98	90		10036722 (M3LH/RHx6)	30026289 (GR - 0N)	10036744 (M3x3)	30026238 (GR - 0)
9,30 - 9,79	170	62	104,5	30	1	108	91	10036722 (M3LH/RHx6)	30026292 (GR - 1N)	10036744 (M3x3)	30026238 (GR - 0)	
9,80 - 11,29	170	62	104,5	30	1	108	91	10036722 (M3LH/RHx6)	30026292 (GR - 1N)	10036744 (M3x3)	30026263 (GR - 1)	
11,30 - 11,79	170	62	104,5	30	1	108	92	10036724 (M4x0,5LH/RHx6,5)	30026294 (GR - 2F)	10036751 (M4x3)	30026266 (GR - 2)	
11,80 - 12,29	170	62	104,5	30	1	108	92	10036724 (M4x0,5LH/RHx6,5)	30026294 (GR - 2F)	10036751 (M4x3)	30026266 (GR - 2)	
12,30 - 13,29	180	62	114,5	30	1	118	92	10036724 (M4x0,5LH/RHx6,5)	30026294 (GR - 2F)	10036752 (M4x4)	30026266 (GR - 2)	
13,30 - 14,29	180	62	114,5	30	1	118	92	10036725 (M4x0,5LH/RHx9)	30026296 (GR - 2N)	10036753 (M4x5)	30026266 (GR - 2)	
14,30 - 15,29	180	62	114,5	30	1	118	92	10036725 (M4x0,5LH/RHx9)	30026296 (GR - 2N)	10036753 (M4x5)	30026266 (GR - 2)	
15,30 - 16,29	200	75	120	30	2	125	92	10036725 (M4x0,5LH/RHx9)	30026296 (GR - 2N)	10036753 (M4x5)	30026266 (GR - 2)	
16,30 - 18,29	210	75	130	30	2	135	92	10036725 (M4x0,5LH/RHx9)	30026296 (GR - 2N)	10036753 (M4x5)	30026266 (GR - 2)	
18,30 - 20,29	220	75	140	30	2	145	92	10036725 (M4x0,5LH/RHx9)	30026296 (GR - 2N)	10036755 (M4x8)	30026266 (GR - 2)	

Ejemplo de pedido (véase la página 480): MN2000 HM 11,8 H7 AS

Medidas en mm.

Otras dimensiones disponibles por solicitud.

SP = placa de corte, no reversible.

Para las indicaciones de ajuste y el montaje de los accesorios, véase el capítulo «Anexo técnico».

* Los valores no indican el rango de ajuste, sino los tamaños para diferentes diámetros (solo ajustables dentro de un rango de tolerancia).

** Con pivote de centrado de 2,5 mm de longitud en caso de d₁ inferior a 7,8 mm.

Por favor, indique la calidad de las guías de apoyo deseada (metal duro, cermet) al realizar el pedido.

Sin ninguna indicación, las guías de apoyo se realizarán en calidad de metal duro.

Herramientas con guías de apoyo en calidad PCD disponibles a partir de ø 8 mm.

Las reparaciones por razones técnicas son posibles a partir de las 8.00 horas.

Precio y plazo de entrega de las herramientas con guías de apoyo en calidad PCD a petición.

Insertos de corte adecuados a partir de la página 494.

Escariador de un filo WP MN2003

Ejecución corta con refrigeración interna

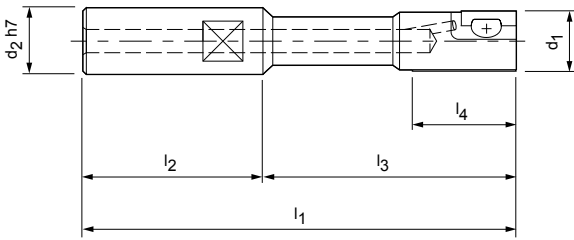

Dimensiones						Tamaño de los insertos de corte	Accesorios			
d ₁ *	d ₂ H7	l ₁	l ₂	l ₃	l ₄		Sujeción		Ajuste	
							Tornillo TORX®/tornillo diferencial	Plaquita de sujeción	Tornillo prisionero MN 620	Cuña de ajuste MN 619
							Referencia (tamaño)			
5,00 - 5,29	10	90**	30	60	15	(SP) 81	10036776 (M1,6x3,9)	30026285 (GR - 1YN)	10036736 (M2x1,8)	30026239 (GR - 06)
5,30 - 5,49	10	90**	30	60	15	(SP) 81	10036778 (M1,6x4,4)	30026285 (GR - 1YN)	10036737 (M2x2)	30026239 (GR - 06)
5,50 - 6,19	10	90**	30	60	15	(SP) 81	10036780 (M2x4)	30026286 (GR - 1X)	10036737 (M2x2)	30026260 (GR - 07)
6,20 - 6,90	10	90**	30	60	15	(SP) 81	10036781 (M2x5)	30026286 (GR - 1X)	10036738 (M2x2,5)	30026260 (GR - 07)
6,91 - 7,49	10	100**	30	70	15	90	10036783 (M2,5x4,8)	30026287 (GR - 1W)	10036730 (M2,5x2,2)	30026261 (GR - 08)
7,50 - 7,79	10	100**	30	70	15	90	10036784 (M2,5x5,2)	30026287 (GR - 1W)	10036731 (M2,5x2,5)	30026262 (GR - 09)
7,80 - 8,29	16	120	45	75	30	90	10036711 (M3LH/RHx5)	30026288 (GR - 0F)	10036743 (M3x2,5)	30026238 (GR - 0)
8,30 - 8,79	16	120	45	75	30	90	10036711 (M3LH/RHx5)	30026288 (GR - 0F)	10036744 (M3x3)	30026238 (GR - 0)
8,80 - 9,29	16	120	45	75	30	90	10036722 (M3LH/RHx6)	30026289 (GR - 0N)	10036744 (M3x3)	30026238 (GR - 0)
9,30 - 9,79	16	120	45	75	30	91	10036722 (M3LH/RHx6)	30026292 (GR - 1N)	10036744 (M3x3)	30026238 (GR - 0)
9,80 - 11,29	16	120	45	75	30	91	10036722 (M3LH/RHx6)	30026292 (GR - 1N)	10036744 (M3x3)	30026263 (GR - 1)
11,30 - 11,79	16	120	45	75	30	92	10036724 (M4x0,5LH/RHx6,5)	30026294 (GR - 2F)	10036751 (M4x3)	30026266 (GR - 2)
11,80 - 12,29	16	120	45	75	30	92	10036724 (M4x0,5LH/RHx6,5)	30026294 (GR - 2F)	10036751 (M4x3)	30026266 (GR - 2)
12,30 - 13,29	16	120	45	75	30	92	10036724 (M4x0,5LH/RHx6,5)	30026294 (GR - 2F)	10036752 (M4x4)	30026266 (GR - 2)
13,30 - 14,29	16	120	45	75	30	92	10036725 (M4x0,5LH/RHx9)	30026296 (GR - 2N)	10036753 (M4x8)	30026266 (GR - 2)
14,30 - 18,29	20	130	55	75	30	92	10036725 (M4x0,5LH/RHx9)	30026296 (GR - 2N)	10036753 (M4x8)	30026266 (GR - 2)
18,30 - 19,79	20	130	55	75	30	92	10036725 (M4x0,5LH/RHx9)	30026296 (GR - 3N)	10036755 (M6x15)	30026266 (GR - 4)
19,80 - 20,29	20	150	55	95	30	92	10036725 (M4x0,5LH/RHx9)	30026296 (GR - 3N)	10036755 (M6x15)	30026266 (GR - 4)

Escariador de un filo WP MN2003

Dimensiones						Tamaño de los insertos de corte	Accesorios				
d ₁ *	d ₂ H7	l ₁	l ₂	l ₃	l ₄		Sujeción		Ajuste		
							Tornillo TORX®/tornillo diferencial	Plaquita de sujeción	Tornillo prisionero MN 620	Cuña de ajuste MN 619	
							Referencia (tamaño)				
20,30 - 26,29	20	150	55	95	30	92	MN 618	10036725 (M4x0,5LH/RHx9)	30026296 (GR - 2N)	10036755 (M4x8)	30026266 (GR - 2)
26,30 - 30,29	25	160	65	95	30	92		10036725 (M4x0,5LH/RHx9)	30026296 (GR - 2N)	10036755 (M4x8)	30026266 (GR - 2)

Ejemplo de pedido (véase la página 480):

MN2003 HM 20,99 H7 AS

Medidas en mm.

Otras dimensiones disponibles por solicitud.

SP = placa de corte, no reversible.

Para las indicaciones de ajuste y el montaje de los accesorios, véase el capítulo «Anexo técnico».

* Los valores no indican el rango de ajuste, sino los tamaños para diferentes diámetros (solo ajustables dentro de un rango de tolerancia).

** Con pivote de centrado de 2,5 mm de longitud en caso de d₁ inferior a 7,8 mm.

Por favor, indique la calidad de las guías de apoyo deseada (metal duro, cermet) al realizar el pedido.

Sin ninguna indicación, las guías de apoyo se realizarán en calidad de metal duro.

Herramientas con guías de apoyo en calidad PCD disponibles a partir de ø 8 mm.

Las reparaciones por razones técnicas son posibles a partir de las 8.00 horas.

Precio y plazo de entrega de las herramientas con guías de apoyo en calidad PCD a petición.

Insertos de corte adecuados a partir de la página 494.

Escariador de un filo WP MN2004

Ejecución corta

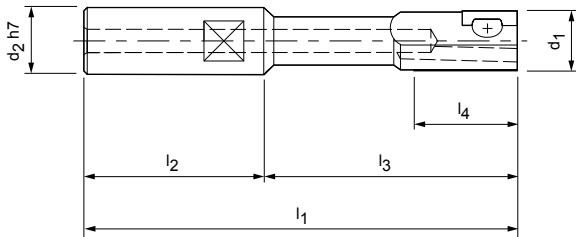

Dimensiones							Accesorios				
d ₁ *	d ₂ H7	l ₁	l ₂	l ₃	l ₄	Tamaño de los insertos de corte	Sujeción		Ajuste		
							Tornillo TORX®/tornillo diferencial	Plaquita de sujeción	Tornillo prisionero MN 620	Cuña de ajuste MN 619	
							Referencia (tamaño)				
5,90 - 6,29	10	90**	30	60	15	(SP) 81	Tornillo Torx	10036776 (M1,6x3,9)	30026285 (GR - 1YN)	10036737 (M2x2)	30026239 (GR - 06)
6,30 - 6,90	10	90**	30	60	15	(SP) 81		10036778 (M1,6x4,4)	30026285 (GR - 1YN)	10036738 (M2x2,5)	30026239 (GR - 06)
6,91 - 7,29	10	100**	30	70	15	(SP) 81		10036778 (M1,6x4,4)	30026285 (GR - 1YN)	10036738 (M2x2,5)	30026239 (GR - 06)
7,30 - 7,79	10	100**	30	70	15	(SP) 81		10036781 (M2x5)	30026286 (GR - 1X)	10036739 (M2x3)	30026260 (GR - 07)
7,80 - 8,29	16	120**	45	75	15	(SP) 81		10036781 (M2x5)	30026286 (GR - 1X)	10036739 (M2x3)	30026260 (GR - 07)
8,30 - 9,79	16	120	45	75	15	90		10036784 (M2,5x5,2)	30026287 (GR - 1W)	10036732 (M2,5x3)	30026262 (GR - 09)
9,80 - 10,29	16	120	45	75	15	90		10036784 (M2,5x5,2)	30026287 (GR - 1W)	10036733 (M2,5x4)	30026262 (GR - 09)
10,30 - 11,29	16	120	45	75	30	90		10036722 (M3LH/RHx6)	30026289 (GR - 0N)	10036744 (M3x3)	30026263 (GR - 1)
11,30 - 12,29	16	120	45	75	30	90		10036722 (M3LH/RHx6)	30026289 (GR - 0N)	10036745 (M3x4)	30026263 (GR - 1)
12,30 - 14,29	16	120	45	75	30	91		10036722 (M3LH/RHx6)	30026292 (GR - 1N)	10036745 (M3x4)	30026263 (GR - 1)
14,30 - 16,29	20	130	55	75	30	91	10036722 (M3LH/RHx6)	30026292 (GR - 1N)	10036747 (M3x6)	30026263 (GR - 1)	
16,30 - 17,29	20	130	55	75	30	92	10036725 (M4x0,5LH/RHx9)	30026296 (GR - 2N)	10036753 (M4x5)	30026266 (GR - 2)	
17,30 - 19,79	20	130	55	75	30	92	10036725 (M4x0,5LH/RHx9)	30026296 (GR - 2N)	10036754 (M4x6)	30026266 (GR - 2)	
19,80 - 26,29	20	150	55	95	30	92	10036725 (M4x0,5LH/RHx9)	30026296 (GR - 2N)	10036755 (M4x8)	30026266 (GR - 2)	
26,30 - 30,29	25	160	65	95	30	92	10036725 (M4x0,5LH/RHx9)	30026296 (GR - 2N)	10036755 (M4x8)	30026266 (GR - 2)	
							Tornillo diferencial MN 618				

Ejemplo de pedido (véase la página 480):

MN2004 HM 20,99 H7 AS

Medidas en mm.

Otras dimensiones disponibles por solicitud.

Para las indicaciones de ajuste y el montaje de los accesorios, véase el capítulo «Anexo técnico».

* Los valores no indican el rango de ajuste, sino los tamaños para diferentes diámetros (solo ajustables dentro de un rango de tolerancia).

** Con pivote de centrado de 1 mm de longitud en caso de d₁ inferior a 8,3 mm.

Por favor, indique la calidad de las guías de apoyo deseada (metal duro, cermet) al realizar el pedido.

Sin ninguna indicación, las guías de apoyo se realizarán en calidad de metal duro.

Herramientas con guías de apoyo en calidad PCD disponibles a partir de ø 8 mm.

Las reparaciones por razones técnicas son posibles a partir de las 8.00 horas.

Precio y plazo de entrega de las herramientas con guías de apoyo en calidad PCD a petición.

Insertos de corte adecuados a partir de la página 494.

Escariador de un filo WP MN2034

Ejecución extracorta

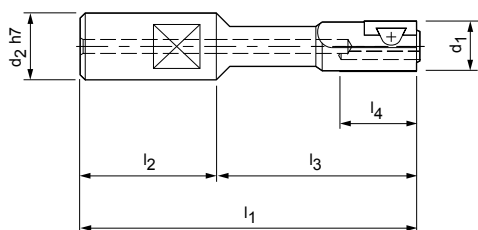

Dimensiones						Tamaño de los insertos de corte	Accesorios				
d ₁ *	d ₂ H7	l ₁	l ₂	l ₃	l ₄		Sujeción		Ajuste		
							Tornillo TORX®/tornillo diferencial	Plaquita de sujeción	Tornillo prisionero MN 620	Cuña de ajuste MN 619	
							Referencia (tamaño)				
5,90 - 6,29	16	85**	27	58	15	(SP) 81	Tornillo Torx	10036776 (M1,6x3,9)	30026285 (GR - 1YN)	10036737 (M2x2)	30026239 (GR - 06)
6,30 - 7,29	16	85**	27	58	15	(SP) 81		10036778 (M1,6x4,4)	30026285 (GR - 1YN)	10036738 (M2x2,5)	30026239 (GR - 06)
7,30 - 8,29	16	85**	27	58	15	(SP) 81		10036781 (M2x5)	30026286 (GR - 1X)	10036739 (M2x3)	30026260 (GR - 07)
8,30 - 9,79	16	85	27	58	15	90		10036784 (M2,5x5,2)	30026287 (GR - 1W)	10036732 (M2,5x3)	30026262 (GR - 09)
9,80 - 10,29	16	85	27	58	15	90		10036784 (M2,5x5,2)	30026287 (GR - 1W)	10036733 (M2,5x4)	30026262 (GR - 09)
10,30 - 11,29	16	85	27	58	30	90	Tornillo diferencial MN 618	10036722 (M3LH/RHx6)	30026289 (GR - 0N)	10036744 (M3x3)	30026263 (GR - 1)
11,30 - 12,29	16	85	27	58	30	90		10036722 (M3LH/RHx6)	30026289 (GR - 0N)	10036745 (M3x4)	30026263 (GR - 1)
12,30 - 14,29	16	85	27	58	30	91		10036722 (M3LH/RHx6)	30026292 (GR - 1N)	10036745 (M3x4)	30026263 (GR - 1)
14,30 - 16,29	16	85	27	58	30	91		10036722 (M3LH/RHx6)	30026292 (GR - 1N)	10036747 (M3x6)	30026263 (GR - 1)
16,30 - 17,29	16	85	27	58	30	92		10036725 (M4x0,5LH/RHx9)	30026296 (GR - 2N)	10036753 (M4x5)	30026266 (GR - 2)
17,30 - 19,79	16	85	27	58	30	92		10036725 (M4x0,5LH/RHx9)	30026296 (GR - 2N)	10036754 (M4x6)	30026266 (GR - 2)
19,80 - 20,29	16	85	27	58	30	92		10036725 (M4x0,5LH/RHx9)	30026296 (GR - 2N)	10036755 (M4x8)	30026266 (GR - 2)
20,30 - 26,30	20	90	30	60	30	92		10036725 (M4x0,5LH/RHx9)	30026296 (GR - 2N)	10036755 (M4x8)	30026266 (GR - 2)
26,30 - 30,29	25	90	30	60	30	92		10036725 (M4x0,5LH/RHx9)	30026296 (GR - 2N)	10036755 (M4x8)	30026266 (GR - 2)

Ejemplo de pedido (véase la página 480):
MN2034 HM 20,99 H7 AS

Medidas en mm.

Otras dimensiones disponibles por solicitud.

SP = placa de corte, no reversible.

Para las indicaciones de ajuste y el montaje de los accesorios, véase el capítulo «Anexo técnico».

* Los valores no indican el rango de ajuste, sino los tamaños para diferentes diámetros (solo ajustables dentro de un rango de tolerancia).

** Con pivote de centrado de 1 mm de longitud en caso de d₁ inferior a 8,3 mm.

Por favor, indique la calidad de las guías de apoyo deseada (metal duro, cermet) al realizar el pedido.

Sin ninguna indicación, las guías de apoyo se realizarán en calidad de metal duro.

Herramientas con guías de apoyo en calidad PCD disponibles a partir de ø 8 mm.

Las reparaciones por razones técnicas son posibles a partir de las 8.00 horas.

Precio y plazo de entrega de las herramientas con guías de apoyo en calidad PCD a petición.

Insertos de corte adecuados a partir de la página 494.

Escariador de un filo WP MN2023

Forma constructiva NC

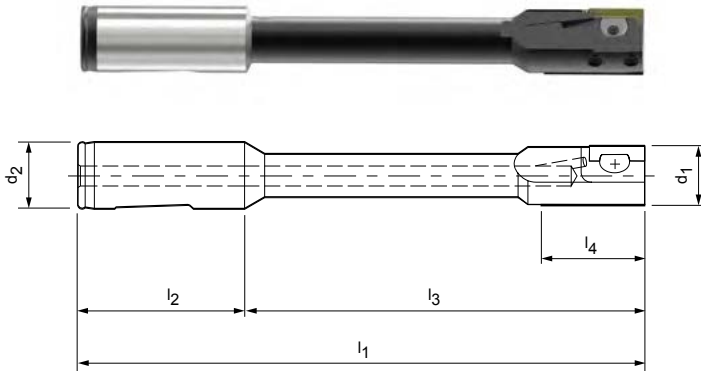

Dimensiones							Accesorios			
d ₁ *	d ₂ (-0,003)	l ₁	l ₂	l ₃	l ₄	Tamaño de los insertos de corte	Sujeción		Ajuste	
							Tornillo diferencial MN 618	Plaquita de sujeción	Tornillo prisionero MN 620	Cuña de ajuste MN 619
							Referencia (tamaño)			
7,80 - 8,29	16	133	48	85	30	90	10036711 (M3LH/RHx5)	30026288 (GR - 0F)	10036743 (M3x2,5)	30026238 (GR - 0)
8,30 - 8,79	16	133	48	85	30	90	10036711 (M3LH/RHx5)	30026288 (GR - 0F)	10036744 (M3x3)	30026238 (GR - 0)
8,80 - 9,29	16	133	48	85	30	90	10036711 (M3LH/RHx5)	30026289 (GR - 0N)	10036744 (M3x3)	30026238 (GR - 0)
9,30 - 11,29	16	133	48	85	30	91	10036722 (M3LH/RHx6)	30026292 (GR - 1N)	10036744 (M3x3)	30026263 (GR - 1)
11,30 - 11,79	16	133	48	85	30	92	10036724 (M4x0,5LH/RHx6,5)	30026294 (GR - 2F)	10036751 (M4x3)	30026266 (GR - 2)
11,80 - 12,29	16	168	48	120	30	92	10036724 (M4x0,5LH/RHx6,5)	30026294 (GR - 2F)	10036751 (M4x3)	30026266 (GR - 2)
12,30 - 13,29	16	168	48	120	30	92	10036724 (M4x0,5LH/RHx6,5)	30026294 (GR - 2F)	10036752 (M4x4)	30026266 (GR - 2)
13,30 - 14,29	16	168	48	120	30	92	10036725 (M4x0,5LH/RHx9)	30026296 (GR - 2N)	10036753 (M4x5)	30026266 (GR - 2)
14,30 - 15,79	20	170	50	120	30	92	10036725 (M4x0,5LH/RHx9)	30026296 (GR - 2N)	10036753 (M4x5)	30026266 (GR - 2)
15,80 - 17,79	20	170	50	120	30	92	10036725 (M4x0,5LH/RHx9)	30026296 (GR - 2N)	10036753 (M4x5)	30026266 (GR - 2)
17,80 - 18,29	20	170	50	120	30	92	10036725 (M4x0,5LH/RHx9)	30026296 (GR - 2N)	10036753 (M4x5)	30026266 (GR - 2)
18,30 - 19,79	20	170	50	120	30	92	10036725 (M4x0,5LH/RHx9)	30026296 (GR - 2N)	10036754 (M4x6)	30026266 (GR - 2)
19,80 - 24,79	20	170	50	120	30	92	10036725 (M4x0,5LH/RHx9)	30026296 (GR - 2N)	10036755 (M4x8)	30026266 (GR - 2)
24,80 - 29,29	20	170	50	120	30	93	10036725 (M4x0,5LH/RHx9)	30026298 (GR - 3N)	10036761 (M6x10)	30026279 (GR - 4)
28,80 - 30,79	20	170	50	120	30	93	10036725 (M4x0,5LH/RHx9)	30026298 (GR - 3N)	10036762 (M6x12)	30026279 (GR - 4)

Ejemplo de pedido (véase la página 480):

MN2023 HM 20,99 H7 AS

Medidas en mm.

Otras dimensiones disponibles por solicitud.

Para las indicaciones de ajuste y el montaje de los accesorios, véase el capítulo «Anexo técnico».

* Los valores no indican el rango de ajuste, sino los tamaños para diferentes diámetros (solo ajustables dentro de un rango de tolerancia).

Por favor, indique la calidad de las guías de apoyo deseada (metal duro, cermet) al realizar el pedido.

Sin ninguna indicación, las guías de apoyo se realizarán en calidad de metal duro.

Herramientas con guías de apoyo en calidad PCD disponibles a partir de ø 8 mm.

Las reparaciones por razones técnicas son posibles a partir de las 8.00 horas.

Precio y plazo de entrega de las herramientas con guías de apoyo en calidad PCD a petición.

Insertos de corte adecuados a partir de la página 494.

Escariador de un filo WP MN2024

Forma constructiva NC

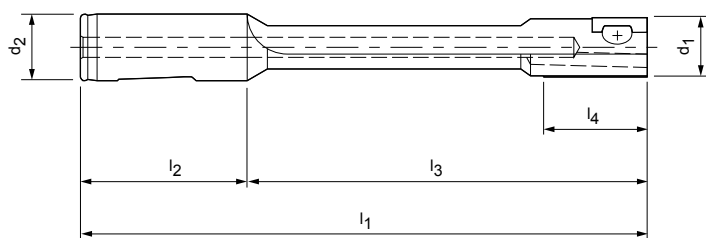

Dimensiones						Tamaño de los insertos de corte	Accesorios			
d ₁ *	d ₂ (-0,003)	l ₁	l ₂	l ₃	l ₄		Sujeción		Ajuste	
							Tornillo diferencial MN 618	Plaquita de sujeción	Tornillo prisionero MN 620	Cuña de ajuste MN 619
							Referencia (tamaño)			
7,80 - 8,29	16	133	48	85	30	90	10036711 (M3LH/RHx5)	30026291 (GR - OZ)	10036743 (M3x2,5)	30026238 (GR - 0)
8,30 - 8,79	16	133	48	85	30	90	10036711 (M3LH/RHx5)	30026291 (GR - OZ)	10036744 (M3x3)	30026238 (GR - 0)
8,80 - 9,29	16	133	48	85	30	90	10036711 (M3LH/RHx5)	30026291 (GR - OZ)	10036744 (M3x3)	30026238 (GR - 0)
9,30 - 11,29	16	133	48	85	30	90	10036722 (M3LH/RHx6)	30026289 (GR - ON)	10036744 (M3x3)	30026263 (GR - 1)
11,30 - 11,79	16	133	48	85	30	90	10036722 (M3LH/RHx6)	30026289 (GR - ON)	10036745 (M3x4)	30026263 (GR - 1)
11,80 - 12,29	16	168	48	120	30	90	10036722 (M3LH/RHx6)	30026289 (GR - ON)	10036745 (M3x4)	30026263 (GR - 1)
12,30 - 14,29	16	168	48	120	30	91	10036722 (M3LH/RHx6)	30026292 (GR - 1N)	10036745 (M3x4)	30026263 (GR - 1)
14,30 - 16,29	20	170	50	120	30	91	10036722 (M3LH/RHx6)	30026292 (GR - 1N)	10036747 (M3x6)	30026263 (GR - 1)
16,30 - 17,29	20	170	50	120	30	92	10036725 (M4x0,5LH/RHx9)	30026296 (GR - 2N)	10036753 (M4x5)	30026266 (GR - 2)
17,30 - 19,79	20	170	50	120	30	92	10036725 (M4x0,5LH/RHx9)	30026296 (GR - 2N)	10036754 (M4x6)	30026266 (GR - 2)
19,80 - 20,79	20	170	50	120	30	92	10036725 (M4x0,5LH/RHx9)	30026296 (GR - 2N)	10036755 (M4x8)	30026266 (GR - 2)

Ejemplo de pedido (véase la página 480):

MN2024 HM 11,99 H7 AS

Medidas en mm.

Otras dimensiones disponibles por solicitud.

Para las indicaciones de ajuste y el montaje de los accesorios, véase el capítulo «Anexo técnico».

* Los valores no indican el rango de ajuste, sino los tamaños para diferentes diámetros (solo ajustables dentro de un rango de tolerancia).

Por favor, indique la calidad de las guías de apoyo deseada (metal duro, cermet) al realizar el pedido.

Sin ninguna indicación, las guías de apoyo se realizarán en calidad de metal duro.

Herramientas con guías de apoyo en calidad PCD disponibles a partir de ø 8 mm.

Las reparaciones por razones técnicas son posibles a partir de las 8.00 horas.

Precio y plazo de entrega de las herramientas con guías de apoyo en calidad PCD a petición.

Insertos de corte adecuados a partir de la página 494.

Escariador de un filo WP MN2043

Forma constructiva NC

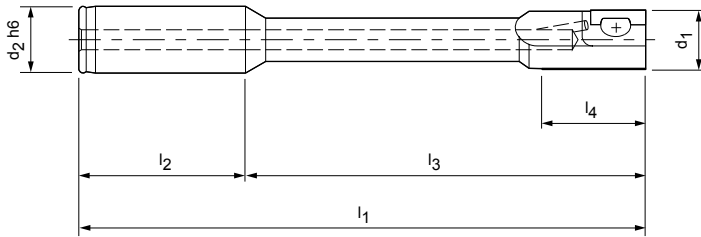

Dimensiones							Accesorios			
d ₁ *	d ₂ h6	l ₁	l ₂	l ₃	l ₄	Tamaño de los insertos de corte	Sujeción		Ajuste	
							Tornillo diferencial MN 618	Plaquita de sujeción	Tornillo prisionero MN 620	Cuña de ajuste MN 619
							Referencia (tamaño)			
7,80 - 8,29	16	133	48	85	30	90	10036711 (M3LH/RHx5)	30026288 (GR - 0F)	10036743 (M3x2,5)	30026238 (GR - 0)
8,30 - 8,79	16	133	48	85	30	90	10036711 (M3LH/RHx5)	30026288 (GR - 0F)	10036744 (M3x3)	30026238 (GR - 0)
8,80 - 9,29	16	133	48	85	30	90	10036711 (M3LH/RHx5)	30026289 (GR - 0N)	10036744 (M3x3)	30026238 (GR - 0)
9,30 - 11,29	16	133	48	85	30	91	10036722 (M3LH/RHx6)	30026292 (GR - 1N)	10036744 (M3x3)	30026263 (GR - 1)
11,30 - 11,79	16	133	48	85	30	92	10036724 (M4x0,5LH/RHx6,5)	30026294 (GR - 2F)	10036751 (M4x3)	30026266 (GR - 2)
11,80 - 12,29	16	168	48	120	30	92	10036724 (M4x0,5LH/RHx6,5)	30026294 (GR - 2F)	10036751 (M4x3)	30026266 (GR - 2)
12,30 - 13,29	16	168	48	120	30	92	10036724 (M4x0,5LH/RHx6,5)	30026294 (GR - 2F)	10036752 (M4x4)	30026266 (GR - 2)
13,30 - 14,29	16	168	48	120	30	92	10036725 (M4x0,5LH/RHx9)	30026296 (GR - 2N)	10036753 (M4x5)	30026266 (GR - 2)
14,30 - 15,79	20	170	50	120	30	92	10036725 (M4x0,5LH/RHx9)	30026296 (GR - 2N)	10036753 (M4x5)	30026266 (GR - 2)
15,80 - 17,79	20	170	50	120	30	92	10036725 (M4x0,5LH/RHx9)	30026296 (GR - 2N)	10036753 (M4x5)	30026266 (GR - 2)
17,80 - 18,29	20	170	50	120	30	92	10036725 (M4x0,5LH/RHx9)	30026296 (GR - 2N)	10036753 (M4x5)	30026266 (GR - 2)
18,30 - 19,79	20	170	50	120	30	92	10036725 (M4x0,5LH/RHx9)	30026296 (GR - 2N)	10036754 (M4x6)	30026266 (GR - 2)
19,80 - 24,79	20	170	50	120	30	92	10036725 (M4x0,5LH/RHx9)	30026296 (GR - 2N)	10036755 (M4x8)	30026266 (GR - 2)
24,80 - 28,79	20	170	50	120	30	93	10036725 (M4x0,5LH/RHx9)	30026298 (GR - 3N)	10036761 (M6x10)	30026279 (GR - 4)
28,80 - 31,79	20	170	50	120	30	93	10036725 (M4x0,5LH/RHx9)	30026298 (GR - 3N)	10036762 (M6x12)	30026279 (GR - 4)
31,80 - 37,79	20	170	50	120	30	93	10036725 (M4x0,5LH/RHx9)	30026298 (GR - 3N)	10036764 (M6x15)	30026279 (GR - 4)
37,80 - 40,29	25	176	56	120	30	93	10036725 (M4x0,5LH/RHx9)	30026298 (GR - 3N)	10036764 (M6x15)	30026279 (GR - 4)

Ejemplo de pedido (véase la página 480):

MN2043 HM 20,99 H7 AS

Medidas en mm.

Otras dimensiones disponibles por solicitud.

Para las indicaciones de ajuste y el montaje de los accesorios, véase el capítulo «Anexo técnico».

* Los valores no indican el rango de ajuste, sino los tamaños para diferentes diámetros (solo ajustables dentro de un rango de tolerancia).

Por favor, indique la calidad de las guías de apoyo deseada (metal duro, cermet) al realizar el pedido.

Sin ninguna indicación, las guías de apoyo se realizarán en calidad de metal duro.

Herramientas con guías de apoyo en calidad PCD disponibles a partir de \varnothing 8 mm.

Las reparaciones por razones técnicas son posibles a partir de las 8.00 horas.

Precio y plazo de entrega de las herramientas con guías de apoyo en calidad PCD a petición.

Insertos de corte adecuados a partir de la página 494.

Escariador de un filo WP MN2044

Forma constructiva NC

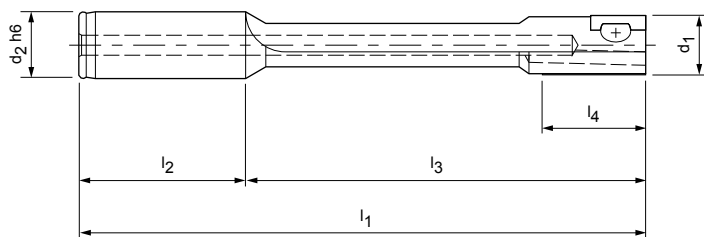

Dimensiones							Accesorios			
d ₁ *	d ₂ h6	l ₁	l ₂	l ₃	l ₄	Tamaño de los insertos de corte	Sujeción		Ajuste	
							Tornillo diferencial MN 618	Plaquita de sujeción	Tornillo prisionero MN 620	Cuña de ajuste MN 619
							Referencia (tamaño)			
7,80 - 8,29	16	133	48	85	30	90	10036711 (M3LH/RHx5)	30026291 (GR - OZ)	10036743 (M3x2,5)	30026238 (GR - 0)
8,30 - 8,79	16	133	48	85	30	90	10036711 (M3LH/RHx5)	30026291 (GR - OZ)	10036744 (M3x3)	30026238 (GR - 0)
8,80 - 9,29	16	133	48	85	30	90	10036711 (M3LH/RHx5)	30026291 (GR - OZ)	10036744 (M3x3)	30026238 (GR - 0)
9,30 - 11,29	16	133	48	85	30	90	10036722 (M3LH/RHx6)	30026289 (GR - ON)	10036744 (M3x3)	30026263 (GR - 1)
11,30 - 11,79	16	133	48	85	30	90	10036722 (M3LH/RHx6)	30026289 (GR - ON)	10036745 (M3x4)	30026263 (GR - 1)
11,80 - 12,29	16	168	48	120	30	90	10036722 (M3LH/RHx6)	30026289 (GR - ON)	10036745 (M3x4)	30026263 (GR - 1)
12,30 - 14,29	16	168	48	120	30	91	10036722 (M3LH/RHx6)	30026292 (GR - 1N)	10036745 (M3x4)	30026263 (GR - 1)
14,30 - 16,29	20	170	50	120	30	91	10036722 (M3LH/RHx6)	30026292 (GR - 1N)	10036747 (M3x6)	30026263 (GR - 1)
16,30 - 17,29	20	170	50	120	30	92	10036725 (M4x0,5LH/RHx9)	30026296 (GR - 2N)	10036753 (M4x5)	30026266 (GR - 2)
17,30 - 19,79	20	170	50	120	30	92	10036725 (M4x0,5LH/RHx9)	30026296 (GR - 2N)	10036754 (M4x6)	30026266 (GR - 2)
19,80 - 20,79	20	170	50	120	30	92	10036725 (M4x0,5LH/RHx9)	30026296 (GR - 2N)	10036755 (M4x8)	30026266 (GR - 2)

Ejemplo de pedido (véase la página 480):

MN2044 HM 11,99 H7 AS

Medidas en mm.

Otras dimensiones disponibles por solicitud.

Para las indicaciones de ajuste y el montaje de los accesorios, véase el capítulo «Anexo técnico».

* Los valores no indican el rango de ajuste, sino los tamaños para diferentes diámetros (solo ajustables dentro de un rango de tolerancia).

Por favor, indique la calidad de las guías de apoyo deseada (metal duro, cermet) al realizar el pedido.

Sin ninguna indicación, las guías de apoyo se realizarán en calidad de metal duro.

Herramientas con guías de apoyo en calidad PCD disponibles a partir de ø 8 mm.

Las reparaciones por razones técnicas son posibles a partir de las 8.00 horas.

Precio y plazo de entrega de las herramientas con guías de apoyo en calidad PCD a petición.

Insertos de corte adecuados a partir de la página 494.

Insertos de corte con entrada AS

Para herramientas con guías de apoyo

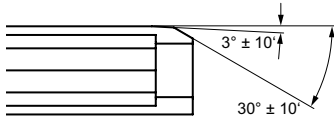

Entrada AS

Entrada adecuada para todos los materiales, alta calidad de superficie incluso a velocidades de corte elevadas. Longitud de entrada de 1,3 mm.

Profundidad de corte máx.: 0,25 mm
Ángulo de desprendimiento: 0°, 6°, 12°

Material de corte	Metal duro								
Grupo de arranque de virutas de Mapal*	P			M	K		N		
	1.1 - 1.2	2 - 3 5	P4 P6	1 - 3	1.1	2 - 3	1.1 - 1.2	2.3	2.1 - 2.2
Clase de materiales de corte	HP115	HP425	HP016	HP016	HC418	HP426	HP612	HU615	

Ángulo de desprendimiento	Tamaño	Especificación	Referencia							
negativo	81	SP-AS81R0-...								
	90	SP-AS90R0-...								
	91	SP-AS91R0-...								
	92	SP-AS92R0-...								
	93	SP-AS93R0-...								

Neutra	81	SP-AS81R0-...								
	90	WP-AS90R0-...								
	91	WP-AS91R0-...								
	92	WP-AS92R0-...								
	93	WP-AS93R0-...								

positivo	81	SP-AS81R6-...	30669442	30669444	31100866	31100866				30669441	
	90	WP-AS90R6-...	30668837	30668839	31100867	31100867				30668836	
	91	WP-AS91R6-...	30668848	30668850	31080268	31080268				30668847	
	92	WP-AS92R6-...	30668858	30668859	30912087	30912087				30668857	
	93	WP-AS93R6-...	30668869	30250310	30915826	30915826				30668868	

muy positivo	81	SP-AS81R2-...								30685605		30669437
	90	WP-AS90R2-...								30685606		30668833
	91	WP-AS91R2-...								30685607		30668844
	92	WP-AS92R2-...								30685608		30668853
	93	WP-AS93R2-...								30685609		30668863

* Grupos de mecanizado MAPAL



Metal duro		
S		H
1 - 2		1.1
HU615		HP016

Cermet	
P	
1 - 3 5	
CP122	

PCD	
N	
1 - 2	
PU620	

PcBN		
K		H
1.1		1.1 - 1.2
FU485		FU801

Referencia		

Referencia	

Referencia	

Referencia		

30668838	
30668849	
30357069	
30305745	

	30669189**
	30669191**
	30669194**
	30669197*
	30669199**

	30669437	
	30668833	
	30668844	
	30668853	
	30668863	

Para la recomendación de valores de corte, véase al final del capítulo.
A petición, los insertsos están disponibles con entrada especial.

Insertos de corte con entrada AZ

Para herramientas con guías de apoyo

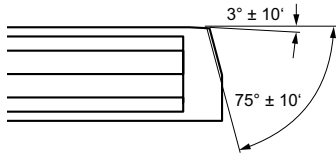

Entrada AZ

Para unas velocidades de corte elevadas; especialmente adecuada para el mecanizado de aluminio.

Profundidad de corte máx.: 0,5 mm
Ángulo de desprendimiento: 0°, 6°, 12°

Material de corte	Metal duro								
Grupo de arranque de virutas de Mapal*	P			M	K		N		
	1.1 - 1.2	2 - 3 5	4 6	1 - 3	1.1	2 - 3	1.1 - 1.2	2.3	2.1 - 2.2
Clase de materiales de corte	HP115	HP425	HP016	HP016	HC418	HP426	HP612	HU615	

Ángulo de desprendimiento	Tamaño	Especificación	Referencia							
negativo	81	SP-AZ81R0-...								
	90	SP-AZ90R0-...								
	91	SP-AZ91R0-...								
	92	SP-AZ92R0-...								
	93	SP-AZ93R0-...								

Neutra	81	SP-AZ81R0-...					30685624				
	90	WP-AZ90R0-...					30670062				
	91	WP-AZ91R0-...					30685625				
	92	WP-AZ92R0-...					30664930				
	93	WP-AZ93R0-...					30664935				

positivo	81	SP-AZ81R6-...						30914241		30668876	
	90	WP-AZ90R6-...						30914251		30668884	
	91	WP-AZ91R6-...						30914261		30668891	
	92	WP-AZ92R6-...						30914275		30668903	
	93	WP-AZ93R6-...						30914304		30668912	

muy positivo	81	SP-AZ81R2-...							30685639		30668875
	90	WP-AZ90R2-...							30685640		30668881
	91	WP-AZ91R2-...							30685641		30668889
	92	WP-AZ92R2-...							30685642		30668899
	93	WP-AZ93R2-...							30685643		30668908

* Grupos de mecanizado MAPAL



Metal duro		
S		H
1 - 2		1.1
HU615		HP016

Cermet	
P	
1 - 3 5	
CP122	

PCD	
N	
1 - 2	
PU620	

PcBN		
K		H
1.1		1.1 - 1.2
FU485		FU801

Referencia		

Referencia	

Referencia	

Referencia		

Para la recomendación de valores de corte, véase al final del capítulo.
A petición, los insertos están disponibles con entrada especial.

Insertos de corte con entrada DZ

Para herramientas con guías de apoyo

Entrada DZ

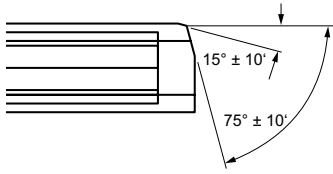

Especialmente para materiales de viruta corta (GG) y grandes profundidades de corte. El ángulo de entrada de 15° del inserto acabador aumenta ligeramente las fuerzas radiales, por lo que también es adecuado para piezas de pared fina

Profundidad de corte máx.: 0,15 mm
Ángulo de desprendimiento: 0°, 6°, 12°

Material de corte	Metal duro								
Grupo de arranque de virutas de Mapal*	P			M	K		N		
Clase de materiales de corte	1.1 - 1.2	2 - 3 5	4 6	1 - 3	1.1	2 - 3	1.1 - 1.2	2.3	2.1 - 2.2
	HP115	HP425	HP016	HP016	HC418	HP426	HP612	HU615	

Ángulo de desprendimiento	Tamaño	Especificación	Referencia						
negativo	81	SP-DZ81R0-...							
	90	SP-DZ90R0-...							
	91	SP-DZ91R0-...							
	92	SP-DZ92R0-...							
	93	SP-DZ93R0-...							

Neutra	81	SP-DZ81R0-...					30685653		
	90	WP-DZ90R0-...					30685654		
	91	WP-DZ91R0-...					30664932		
	92	WP-DZ92R0-...					30685655		
	93	WP-DZ93R0-...					30667699		

positivo	81	SP-DZ81R6-...	30668927	30668928	31090592	31090592		30914351	30668926
	90	WP-DZ90R6-...	30668936	30668785	31034657	31034657		30914370	30668935
	91	WP-DZ91R6-...	30668949	30668950	31028496	31028496		30914400	30668947
	92	WP-DZ92R6-...	30668960	30668961	31100878	31100878		30914435	30668959
	93	WP-DZ93R6-...	30668969	30668970	31069730	31069730		30914474	30668968

muy positivo	81	SP-DZ81R2-...						30685663	30668923
	90	WP-DZ90R2-...						30685664	30668933
	91	WP-DZ91R2-...						30685665	30668942
	92	WP-DZ92R2-...						30685666	30668956
	93	WP-DZ93R2-...						30685667	30668965

* Grupos de mecanizado MAPAL



Metal duro		
S		H
1 - 2		1.1
HU615		HP016

Cermet	
P	
1 - 3 5	
CP122	

PCD	
N	
1 - 2	
PU620	

PcBN		
K		H
1.1		1.1 - 1.2
FU485		FU801

Referencia		

Referencia	

Referencia	

Referencia		

		31090592
		31034657
		31028496
		31100878
		31069730

	30773222
	30668948
	30314334
	30895254

	30669224**
	30669464**
	30669467**
	30669471**
	30669473**

	30668923	
	30668933	
	30668942	
	30668956	
	30668965	

Para la recomendación de valores de corte, véase al final del capítulo.
A petición, los insertos están disponibles con entrada especial.

Insertos de corte con entrada EK

Para herramientas con guías de apoyo

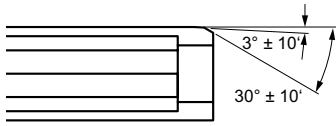

Entrada EK

Utilizar únicamente cuando se requiere una longitud de entrada reducida de 0,6 mm, para todos los materiales, no sobrepasar un avance máx. de 0,2 mm/vuelta.

Profundidad de corte máx.: 0,15 mm
Ángulo de desprendimiento: 0°, 6°, 12°

Material de corte	Metal duro								
Grupo de arranque de virutas de Mapal*	P			M	K		N		
Clase de materiales de corte	1.1 - 1.2	2 - 3 5	4 6	1 - 3	1.1	2 - 3	1.1 - 1.2	2.3	2.1 - 2.2
	HP115	HP425	HP016	HP016	HC418	HP426	HP612	HU615	

Ángulo de desprendimiento	Tamaño	Especificación	Referencia						
negativo	181	SP-EK181R0-...							
	150	SP-EK150R0-...							
	151	SP-EK151R0-...							
	152	SP-EK152R0-...							
	153	SP-EK153R0-...							

Neutra	181	SP-EK181R0-...							
	150	WP-EK150R0-...							
	151	WP-EK151R0-...							
	152	WP-EK152R0-...							
	153	WP-EK153R0-...							

positivo	181	SP-EK181R6-...	30681706	30681707	31100872	31100872			30681705
	150	WP-EK150R6-...	30668978	30668979	31100873	31100873			30668977
	151	WP-EK151R6-...	30668987	30389077	31049120	31049120			30668986
	152	WP-EK152R6-...	30668999	30669000	30990556	30990556			30668998
	153	WP-EK153R6-...	30669009	30669010	31100874	31100874			30669008

muy positivo	181	SP-EK181R2-...						30685689	30681702
	150	WP-EK150R2-...						30685690	30668974
	151	WP-EK151R2-...						30685691	30668983
	152	WP-EK152R2-...						30685692	30668993
	153	WP-EK153R2-...						30685693	30669006

* Grupos de mecanizado MAPAL



Metal duro		
S		H
1 - 2		1.1
HU615		HP016

Cermet	
P	
1 - 3 5	
CP122	

PCD	
N	
1 - 2	
PU620	

PcBN		
K		H
1.1 - 1.2		1.1 - 1.2
FU485		FU801

Referencia		

Referencia	

Referencia	

Referencia		

30685694	
30685695	
30313884	
30543106	

30681710**	
30669474**	
30669475**	
30669477**	
30669479**	

30681702		
30668974		
30668983		
30668993		
30669006		

Para la recomendación de valores de corte, véase al final del capítulo.
 A petición, los insertos están disponibles con entrada especial.

Insertos de corte con entrada SZ

Para herramientas con guías de apoyo

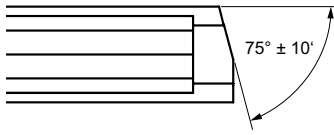

Entrada SZ

Especialmente para aleaciones de fundición de aluminio, muy buena superficie con avances reducidos. Las dimensiones de las ranuras se respetan con precisión. El ángulo de entrada de 75° del inserto principal reduce las fuerzas radiales, por lo que también es adecuado para piezas de pared fina.

Profundidad de corte máx.: 1,00 mm
Ángulo de desprendimiento: 6°, 12°

Material de corte	Metal duro								
Grupo de arranque de virutas de Mapal*	P			M	K		N		
Clase de materiales de corte	1.1 - 1.2	2 - 3 5	4 6	1 - 3	1.1	2 - 3	1.1 - 1.2	2.3	2.1 - 2.2
	HP115	HP425	HP016	HP016	HC418	HP426	HP612	HU615	

Ángulo de desprendimiento	Tamaño	Especificación	Referencia							
negativo	81	SP-SZ81R0-...								
	90	SP-SZ90R0-...								
	91	SP-SZ91R0-...								
	92	SP-SZ92R0-...								
	93	SP-SZ93R0-...								

Neutra	81	SP-SZ81R0-...								
	90	WP-SZ90R0-...								
	91	WP-SZ91R0-...								
	92	WP-SZ92R0-...								
	93	WP-SZ93R0-...								

positivo	81	SP-SZ81R6-...							31306727	30669514
	90	WP-SZ90R6-...							31306729	30669523
	91	WP-SZ91R6-...							31306730	30669534
	92	WP-SZ92R6-...							30690795	30669541
	93	WP-SZ93R6-...							31306732	30669549

muy positivo	81	SP-SZ81R2-...								30669511
	90	WP-SZ90R2-...								30669520
	91	WP-SZ91R2-...								30669531
	92	WP-SZ92R2-...								30669538
	93	WP-SZ93R2-...								30669546

* Grupos de mecanizado MAPAL

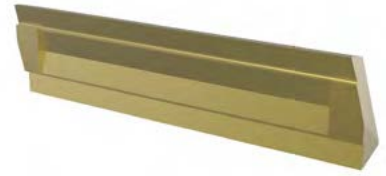

Metal duro		
S		H
1 - 2		1.1
HU615		HP016

Cermet	
P	
1 - 3 5	
CP122	

PCD	
N	
1 - 2	
PU620	

PcBN		
K		H
1.1 - 1.2		
FU485		FU801

Referencia		

Referencia	

Referencia	

Referencia		

	30669493**
	30669494**
	30669495**
	30669498**
	30669502**

Para la recomendación de valores de corte, véase al final del capítulo.
A petición, los insertos están disponibles con entrada especial.

Recomendación de valores de corte para insertos de corte con entrada AS

Avance y velocidad de corte

AS-HP115

Grupo de arranque de virutas de Mapal*	Material	Rigidez/dureza [N/mm ²] [HRC]	Velocidad de corte v _c (m/min)		Avance f _z (mm/z)	
			Refrigeración interna	Refrigeración exterior		
P P1	P1.1	Aceros de construcción, para tornos automáticos, de cementación y revenidos, no aleados	< 700	80	40	0,150
	P1.2	Aceros de construcción, para tornos automáticos, de cementación y revenidos, no aleados	< 1200	70	35	0,150

AS-HP425

Grupo de arranque de virutas de Mapal*	Material	Rigidez/dureza [N/mm ²] [HRC]	Velocidad de corte v _c (m/min)		Avance f _z (mm/z)		
			Refrigeración interna	Refrigeración exterior			
P P2	P2.1	Aceros nitrurados, de cementación y aceros revenidos, aleados	< 900	100	50	0,150	
	P2.2	Aceros nitrurados, de cementación y aceros revenidos, aleados	< 1400	80	40	0,150	
	P3	P3.1	Aceros para herramientas, rodamientos, resortes y rápidos**	< 900	100	50	0,150
		P3.2	Aceros para herramientas, rodamientos, resortes y rápidos**	< 1500	80	40	0,150
	P5	P5.1	Fundición de acero		80	40	0,150

AS-HP016

Grupo de arranque de virutas de Mapal*	Material	Rigidez/dureza [N/mm ²] [HRC]	Velocidad de corte v _c (m/min)		Avance f _z (mm/z)	
			Refrigeración interna	Refrigeración exterior		
P P4	P4.1	Aceros inoxidables, ferríticos y martensíticos		50	25	0,120
	P6	P6.1	Fundición de acero inoxidable, ferrítica y martensítica	40	20	0,120
M M1	M1.1	Aceros inoxidables, austeníticos	< 700	50	25	0,120
	M1.2	Aceros inoxidables, ferríticos/austeníticos (dúplex)	< 1000	30	15	0,120
	M2	M2.1	Fundición de acero inoxidable, austenítica	< 700	50	25
M3	M3.1	Fundición de acero inoxidable, ferrítica/austenítica (dúplex)	< 1000	30	15	0,120

AS-HP612

Grupo de arranque de virutas de Mapal*	Material	Rigidez/dureza [N/mm ²] [HRC]	Velocidad de corte v _c (m/min)		Avance f _z (mm/z)	
			Refrigeración interna	Refrigeración exterior		
N N1	N1.1	Aluminio, aleado y no aleado < 3 % Si		160	80	0,150
	N1.2	Aluminio, aleado ≤ 7 % Si		160	80	0,150

* Grupos de mecanizado MAPAL

** Si los componentes de aleación de Cr, Mo, Ni, V, W suman > 8 %, elegir el siguiente grupo de mecanizado MAPAL superior.

AS-HU615

Grupo de arranque de virutas de Mapal*	Material	Rigidez/dureza [N/mm ²] [HRC]	Velocidad de corte v _c (m/min)		Avance f _z (mm/z)	
			Refrigeración interna	Refrigeración exterior		
N	N2.1	Cobre, no aleado y de baja aleación	< 300	100	50	0,150
	N2.2	Cobre, aleado	> 300	100	50	0,150
	N2.3	Latón, bronce, fundición roja	< 1200	100	50	0,150
S	S1.1	Titanio, aleaciones de titanio	< 400	30	15	0,120
	S2.1	Titanio, aleaciones de titanio	< 1200	20	10	0,120
	S2.2	Titanio, aleaciones de titanio	> 1200	20	10	0,100

AS-CP122

Grupo de arranque de virutas de Mapal*	Material	Rigidez/dureza [N/mm ²] [HRC]	Velocidad de corte v _c (m/min)		Avance f _z (mm/z)	
			Refrigeración interna	Refrigeración exterior		
P1	P1.1	Aceros de construcción, para tornos automáticos, de cementación y revenidos, no aleados	< 700	180	90	0,150
	P1.2	Aceros de construcción, para tornos automáticos, de cementación y revenidos, no aleados	< 1200	160	80	0,120
P2	P2.1	Aceros nitrurados, de cementación y aceros revenidos, aleados	< 900	160	80	0,150
	P2.2	Aceros nitrurados, de cementación y aceros revenidos, aleados	< 1400	140	70	0,120
P3	P3.1	Aceros para herramientas, rodamientos, resortes y rápidos**	< 800	160	80	0,150
	P3.2	Aceros para herramientas, rodamientos, resortes y rápidos**	< 1000	160	80	0,150
	P3.3	Aceros para herramientas, rodamientos, resortes y rápidos**	< 1500	140	70	0,120
P5	P5.1	Fundición de acero		140	70	0,120

AS-PU620

Grupo de arranque de virutas de Mapal*	Material	Rigidez/dureza [N/mm ²] [HRC]	Velocidad de corte v _c (m/min)		Avance f _z (mm/z)	
			Refrigeración interna	Refrigeración exterior		
N	N1.1	Aluminio, aleado y no aleado < 3 % Si		230	115	0,150
	N1.2	Aluminio, aleado ≤ 7 % Si		230	115	0,150
	N1.3	Aluminio, aleado > 7-12 % Si		230	115	0,150
	N1.4	Aluminio, aleado > 12 % Si		230	115	0,150
N2	N2.1	Cobre, no aleado y de baja aleación	< 300	180	90	0,150
	N2.2	Cobre, aleado	> 300	180	90	0,150
	N2.3	Latón, bronce, fundición roja	< 1200	180	90	0,150

Los valores de corte indicados son de referencia.

Los datos óptimos para cada situación de mecanizado deben determinarse mediante ensayos o durante el propio proceso de mecanizado.

Recomendación de valores de corte para insertos de corte con entrada AZ

Avance y velocidad de corte

AZ-HC418

Grupo de arranque de virutas de Mapal*	Material	Rigidez/dureza [N/mm ²] [HRC]	Velocidad de corte v _c (m/min)		Avance f _z (mm/z)
			Refrigeración interna	Refrigeración exterior	
K K1 K1.1	Hierro fundido con grafito laminar (fundición gris), GJL	< 300	110	55	0,150

AZ-HP426

Grupo de arranque de virutas de Mapal*	Material	Rigidez/dureza [N/mm ²] [HRC]	Velocidad de corte v _c (m/min)		Avance f _z (mm/z)	
			Refrigeración interna	Refrigeración exterior		
K	K2	K2.1 Hierro fundido con grafito esférico, GJS	< 500	110	55	0,150
		K2.2 Hierro fundido con grafito esférico, GJS	≤ 800	100	50	0,150
		K2.3 Hierro fundido con grafito esférico, GJS	> 800	80	40	0,150
	K3	K3.1 Hierro fundido con grafito vermicular, GJV; fundición maleable, GJM	< 500	80	40	0,150
		K3.2 Hierro fundido con grafito vermicular, GJV; fundición maleable, GJM	> 500	80	40	0,150

AZ-HP612

Grupo de arranque de virutas de Mapal*	Material	Rigidez/dureza [N/mm ²] [HRC]	Velocidad de corte v _c (m/min)		Avance f _z (mm/z)
			Refrigeración interna	Refrigeración exterior	
N N1	N1.1 Aluminio, aleado y no aleado < 3 % Si		160	80	0,150
	N1.2 Aluminio, aleado ≤ 7 % Si		160	80	0,150

AZ-HU615

Grupo de arranque de virutas de Mapal*	Material	Rigidez/dureza [N/mm ²] [HRC]	Velocidad de corte v _c (m/min)		Avance f _z (mm/z)
			Refrigeración interna	Refrigeración exterior	
N2	N2.1 Cobre, no aleado y de baja aleación	< 300	110	55	0,150
	N2.2 Cobre, aleado	> 300	110	55	0,150
	N2.3 Latón, bronce, fundición roja	< 1200	110	55	0,150

AZ-PU620

Grupo de arranque de virutas de Mapal*	Material	Rigidez/dureza [N/mm ²] [HRC]	Velocidad de corte v _c (m/min)		Avance f _z (mm/z)	
			Refrigeración interna	Refrigeración exterior		
N	N1.1	Aluminio, aleado y no aleado < 3 % Si		230	115	0,150
	N1.2	Aluminio, aleado ≤ 7 % Si		230	115	0,150
	N1.3	Aluminio, aleado > 7-12 % Si		230	115	0,150
	N1.4	Aluminio, aleado > 12 % Si		230	115	0,150
N2	N2.1	Cobre, no aleado y de baja aleación	< 300	180	90	0,150
	N2.2	Cobre, aleado	> 300	180	90	0,150
	N2.3	Latón, bronce, fundición roja	< 1200	180	90	0,150

AZ-FU485

Grupo de arranque de virutas de Mapal*	Material	Rigidez/dureza [N/mm ²] [HRC]	Velocidad de corte v _c (m/min)		Avance f _z (mm/z)	
			Refrigeración interna	Refrigeración exterior		
K K1	K1.1	Hierro fundido con grafito laminar (fundición gris), GJL	< 300	160	80	0,150

Los valores de corte indicados son de referencia.

Los datos óptimos para cada situación de mecanizado deben determinarse mediante ensayos o durante el propio proceso de mecanizado.

Recomendación de valores de corte para insertos de corte con entrada DZ

Avance y velocidad de corte

DZ-HP115

Grupo de arranque de virutas de Mapal*	Material	Rigidez/dureza [N/mm ²] [HRC]	Velocidad de corte v _c (m/min)		Avance f _z (mm/z)	
			Refrigeración interna	Refrigeración exterior		
P P1	P1.1	Aceros de construcción, para tornos automáticos, de cementación y revenidos, no aleados	< 700	80	40	0,150
	P1.2	Aceros de construcción, para tornos automáticos, de cementación y revenidos, no aleados	< 1200	70	35	0,150

DZ-HP425

Grupo de arranque de virutas de Mapal*	Material	Rigidez/dureza [N/mm ²] [HRC]	Velocidad de corte v _c (m/min)		Avance f _z (mm/z)		
			Refrigeración interna	Refrigeración exterior			
P P2	P2.1	Aceros nitrurados, de cementación y aceros revenidos, aleados	< 900	100	50	0,150	
	P2.2	Aceros nitrurados, de cementación y aceros revenidos, aleados	< 1400	80	40	0,150	
	P3	P3.1	Aceros para herramientas, rodamientos, resortes y rápidos**	< 900	100	50	0,150
		P3.2	Aceros para herramientas, rodamientos, resortes y rápidos**	< 1500	80	40	0,150
	P5	P5.1	Fundición de acero		80	40	0,150

DZ-HP016

Grupo de arranque de virutas de Mapal*	Material	Rigidez/dureza [N/mm ²] [HRC]	Velocidad de corte v _c (m/min)		Avance f _z (mm/z)	
			Refrigeración interna	Refrigeración exterior		
P P4	P4.1	Aceros inoxidables, ferríticos y martensíticos		50	25	0,120
	P6	P6.1	Fundición de acero inoxidable, ferrítica y martensítica	40	20	0,120
M M1	M1.1	Aceros inoxidables, austeníticos	< 700	50	25	0,120
	M1.2	Aceros inoxidables, ferríticos/austeníticos (dúplex)	< 1000	30	15	0,120
	M2	M2.1	Fundición de acero inoxidable, austenítica	< 700	50	25
M3	M3.1	Fundición de acero inoxidable, ferrítica/austenítica (dúplex)	< 1000	30	15	0,120

DZ-HC418

Grupo de arranque de virutas de Mapal*	Material	Rigidez/dureza [N/mm ²] [HRC]	Velocidad de corte v _c (m/min)		Avance f _z (mm/z)	
			Refrigeración interna	Refrigeración exterior		
K K1	K1.1	Hierro fundido con grafito laminar (fundición gris), GJL	< 300	100	50	0,150

* Grupos de mecanizado MAPAL

** Si los componentes de aleación de Cr, Mo, Ni, V, W suman > 8 %, elegir el siguiente grupo de mecanizado MAPAL superior.

DZ-HP426

Grupo de arranque de virutas de Mapal*	Material	Rigidez/dureza [N/mm ²] [HRC]	Velocidad de corte v _c (m/min)		Avance f _z (mm/z)
			Refrigeración interna	Refrigeración exterior	
K2	K2.1 Hierro fundido con grafito esferoidal, GJS	< 500	100	50	0,150
	K2.2 Hierro fundido con grafito esferoidal, GJS	≤ 800	90	45	0,150
	K2.3 Hierro fundido con grafito esferoidal, GJS	> 800	80	40	0,150
K3	K3.1 Hierro fundido con grafito vermicular, GJV; fundición maleable, GJM	< 500	70	35	0,150
	K3.2 Hierro fundido con grafito vermicular, GJV; fundición maleable, GJM	> 500	70	35	0,150

DZ-HP612

Grupo de arranque de virutas de Mapal*	Material	Rigidez/dureza [N/mm ²] [HRC]	Velocidad de corte v _c (m/min)		Avance f _z (mm/z)
			Refrigeración interna	Refrigeración exterior	
N N1	N1.1 Aluminio, aleado y no aleado < 3 % Si		160	80	0,150
	N1.2 Aluminio, aleado ≤ 7 % Si		160	80	0,150

DZ-HU615

Grupo de arranque de virutas de Mapal*	Material	Rigidez/dureza [N/mm ²] [HRC]	Velocidad de corte v _c (m/min)		Avance f _z (mm/z)
			Refrigeración interna	Refrigeración exterior	
N N2	N2.1 Cobre, no aleado y de baja aleación	< 300	100	50	0,150
	N2.2 Cobre, aleado	> 300	100	50	0,150
	N2.3 Latón, bronce, fundición roja	< 1200	100	50	0,150
S S1 S2	S1.1 Titanio, aleaciones de titanio	< 400	30	15	0,120
	S2.1 Titanio, aleaciones de titanio	< 1200	20	10	0,120
	S2.2 Titanio, aleaciones de titanio	> 1200	20	10	0,100

DZ-HP016

Grupo de arranque de virutas de Mapal*	Material	Rigidez/dureza [N/mm ²] [HRC]	Velocidad de corte v _c (m/min)		Avance f _z (mm/z)
			Refrigeración interna	Refrigeración exterior	
H H1 H1.1	Acero templado/fundición de acero	45 - 55	30	15	0,12

Los valores de corte indicados son de referencia.

Los datos óptimos para cada situación de mecanizado deben determinarse mediante ensayos o durante el propio proceso de mecanizado.

Recomendación de valores de corte para insertos de corte con entrada DZ

Avance y velocidad de corte

DZ-CP122

Grupo de arranque de virutas de Mapal*	Material	Rigidez/dureza [N/mm ²] [HRC]	Velocidad de corte v _c (m/min)		Avance f _z (mm/z)	
			Refrigeración interna	Refrigeración exterior		
P1	P1.1	Aceros de construcción, para tornos automáticos, de cementación y revenidos, no aleados	< 700	180	80	0,150
	P1.2	Aceros de construcción, para tornos automáticos, de cementación y revenidos, no aleados	< 1200	160	80	0,120
P2	P2.1	Aceros nitrurados, de cementación y aceros revenidos, aleados	< 900	160	80	0,150
	P2.2	Aceros nitrurados, de cementación y aceros revenidos, aleados	< 1400	140	70	0,120
P3	P3.1	Aceros para herramientas, rodamientos, resortes y rápidos**	< 800	160	80	0,150
	P3.2	Aceros para herramientas, rodamientos, resortes y rápidos**	< 1000	160	80	0,150
	P3.3	Aceros para herramientas, rodamientos, resortes y rápidos**	< 1500	140	70	0,120
P5	P5.1	Fundición de acero		140	70	0,120

DZ-PU620

Grupo de arranque de virutas de Mapal*	Material	Rigidez/dureza [N/mm ²] [HRC]	Velocidad de corte v _c (m/min)		Avance f _z (mm/z)	
			Refrigeración interna	Refrigeración exterior		
N1	N1.1	Aluminio, aleado y no aleado < 3 % Si		230	150	0,15
	N1.2	Aluminio, aleado ≤ 7 % Si		230	150	0,15
	N1.3	Aluminio, aleado > 7-12 % Si		230	150	0,15
	N1.4	Aluminio, aleado > 12 % Si		230	150	0,15
N2	N2.1	Cobre, no aleado y de baja aleación	< 300	180	90	0,15
	N2.2	Cobre, aleado	> 300	180	90	0,15
	N2.3	Latón, bronce, fundición roja	< 1200	180	90	0,15

DZ-FU485

Grupo de arranque de virutas de Mapal*	Material	Rigidez/dureza [N/mm ²] [HRC]	Velocidad de corte v _c (m/min)		Avance f _z (mm/z)	
			Refrigeración interna	Refrigeración exterior		
K K1	K1.1	Hierro fundido con grafito laminar (fundición gris), GJL	< 300	150	75	0,150

DZ-FU801

Grupo de arranque de virutas de Mapal*	Material	Rigidez/dureza [N/mm ²] [HRC]	Velocidad de corte v _c (m/min)		Avance f _z (mm/z)	
			Refrigeración interna	Refrigeración exterior		
H H1	H1.1	Acero templado/fundición de acero	45 - 55	60	30	0,100
	H1.2	Acero templado/fundición de acero	55 - 64	50	25	0,080

* Grupos de mecanizado MAPAL

** Si los componentes de aleación de Cr, Mo, Ni, V, W suman > 8 %, elegir el siguiente grupo de mecanizado MAPAL superior.

Recomendación de valores de corte para insertos de corte con entrada EK

Avance y velocidad de corte

EK-HP115

Grupo de arranque de virutas de Mapal*	Material	Rigidez/dureza [N/mm ²] [HRC]	Velocidad de corte v _c (m/min)		Avance f _z (mm/z)	
			Refrigeración interna	Refrigeración exterior		
P P1	P1.1	Aceros de construcción, para tornos automáticos, de cementación y revenidos, no aleados	< 700	80	40	0,150
	P1.2	Aceros de construcción, para tornos automáticos, de cementación y revenidos, no aleados	< 1200	70	35	0,150

EK-HP425

Grupo de arranque de virutas de Mapal*	Material	Rigidez/dureza [N/mm ²] [HRC]	Velocidad de corte v _c (m/min)		Avance f _z (mm/z)		
			Refrigeración interna	Refrigeración exterior			
P P2	P2.1	Aceros nitrurados, de cementación y aceros revenidos, aleados	< 900	100	50	0,150	
	P2.2	Aceros nitrurados, de cementación y aceros revenidos, aleados	< 1400	80	40	0,150	
	P3	P3.1	Aceros para herramientas, rodamientos, resortes y rápidos**	< 900	100	50	0,150
		P3.2	Aceros para herramientas, rodamientos, resortes y rápidos**	< 1500	80	40	0,150
	P5	P5.1	Fundición de acero		80	40	0,150

EK-HP016

Grupo de arranque de virutas de Mapal*	Material	Rigidez/dureza [N/mm ²] [HRC]	Velocidad de corte v _c (m/min)		Avance f _z (mm/z)		
			Refrigeración interna	Refrigeración exterior			
P4	P4.1	Aceros inoxidables, ferríticos y martensíticos		50	25	0,120	
	P6	P6.1	Fundición de acero inoxidable, ferrítica y martensítica	40	20	0,120	
M	M1	M1.1	Aceros inoxidables, austeníticos	< 700	50	25	0,120
		M1.2	Aceros inoxidables, ferríticos/austeníticos (dúplex)	< 1000	30	15	0,120
	M3	M2.1	Fundición de acero inoxidable, austenítica	< 700	50	25	0,120
		M3.1	Fundición de acero inoxidable, ferrítica/austenítica (dúplex)	< 1000	30	15	0,120

EK-HP612

Grupo de arranque de virutas de Mapal*	Material	Rigidez/dureza [N/mm ²] [HRC]	Velocidad de corte v _c (m/min)		Avance f _z (mm/z)	
			Refrigeración interna	Refrigeración exterior		
N N1	N1.1	Aluminio, aleado y no aleado < 3 % Si		160	80	0,15
	N1.2	Aluminio, aleado ≤ 7 % Si		160	80	0,15

Los valores de corte indicados son de referencia.

Los datos óptimos para cada situación de mecanizado deben determinarse mediante ensayos o durante el propio proceso de mecanizado.

Recomendación de valores de corte para insertos de corte con entrada EK

Avance y velocidad de corte

EK-HU615

Grupo de arranque de virutas de Mapal*	Material	Rigidez/dureza [N/mm ²] [HRC]	Velocidad de corte v _c (m/min)		Avance f _z (mm/z)	
			Refrigeración interna	Refrigeración exterior		
N	N2.1	Cobre, no aleado y de baja aleación	< 300	100	50	0,150
	N2.2	Cobre, aleado	> 300	100	50	0,150
	N2.3	Latón, bronce, fundición roja	< 1200	100	50	0,150
S	S1.1	Titanio, aleaciones de titanio	< 400	30	15	0,120
	S2.1	Titanio, aleaciones de titanio	< 1200	20	10	0,120
	S2.2	Titanio, aleaciones de titanio	> 1200	20	10	0,100

EK-CP122

Grupo de arranque de virutas de Mapal*	Material	Rigidez/dureza [N/mm ²] [HRC]	Velocidad de corte v _c (m/min)		Avance f _z (mm/z)	
			Refrigeración interna	Refrigeración exterior		
P	P1.1	Aceros de construcción, para tornos automáticos, de cementación y revenidos, no aleados	< 700	180	90	0,150
	P1.2	Aceros de construcción, para tornos automáticos, de cementación y revenidos, no aleados	< 1200	160	80	0,120
	P2.1	Aceros nitrurados, de cementación y aceros revenidos, aleados	< 900	160	80	0,150
	P2.2	Aceros nitrurados, de cementación y aceros revenidos, aleados	< 1400	140	70	0,120
	P3.1	Aceros para herramientas, rodamientos, resortes y rápidos**	< 800	160	80	0,150
	P3.2	Aceros para herramientas, rodamientos, resortes y rápidos**	< 1000	160	80	0,150
	P3.3	Aceros para herramientas, rodamientos, resortes y rápidos**	< 1500	140	70	0,120
	P5.1	Fundición de acero		140	70	0,120

EK-PU620

Grupo de arranque de virutas de Mapal*	Material	Rigidez/dureza [N/mm ²] [HRC]	Velocidad de corte v _c (m/min)		Avance f _z (mm/z)	
			Refrigeración interna	Refrigeración exterior		
N	N1.1	Aluminio, aleado y no aleado < 3 % Si		230	115	0,150
	N1.2	Aluminio, aleado ≤ 7 % Si		230	115	0,150
	N1.3	Aluminio, aleado > 7-12 % Si		230	115	0,150
	N1.4	Aluminio, aleado > 12 % Si		230	115	0,150
	N2.1	Cobre, no aleado y de baja aleación	< 300	180	90	0,150
	N2.2	Cobre, aleado	> 300	180	90	0,150
	N2.3	Latón, bronce, fundición roja	< 1200	180	90	0,150

* Grupos de mecanizado MAPAL

** Si los componentes de aleación de Cr, Mo, Ni, V, W suman > 8 %, elegir el siguiente grupo de mecanizado MAPAL superior.

Recomendación de valores de corte para insertos de corte con entrada SZ

Avance y velocidad de corte

SZ-HP612

Grupo de arranque de virutas de Mapal*	Material	Rigidez/dureza [N/mm ²] [HRC]	Velocidad de corte v _c (m/min)		Avance f _z (mm/z)
			Refrigeración interna	Refrigeración exterior	
N N1	N1.1 Aluminio, aleado y no aleado < 3 % Si		160	80	0,120
	N1.2 Aluminio, aleado ≤ 7 % Si		160	80	0,120

SZ-HU615

Grupo de arranque de virutas de Mapal*	Material	Rigidez/dureza [N/mm ²] [HRC]	Velocidad de corte v _c (m/min)		Avance f _z (mm/z)
			Refrigeración interna	Refrigeración exterior	
N2	N2.1 Cobre, no aleado y de baja aleación	< 300	100	50	0,120
	N2.2 Cobre, aleado	> 300	100	50	0,120
	N2.3 Latón, bronce, fundición roja	< 1200	100	50	0,120

SZ-PU620

Grupo de arranque de virutas de Mapal*	Material	Rigidez/dureza [N/mm ²] [HRC]	Velocidad de corte v _c (m/min)		Avance f _z (mm/z)
			Refrigeración interna	Refrigeración exterior	
N N1	N1.1 Aluminio, aleado y no aleado < 3 % Si		230	115	0,120
	N1.2 Aluminio, aleado ≤ 7 % Si		230	115	0,120
	N1.3 Aluminio, aleado > 7-12 % Si		230	115	0,120
	N1.4 Aluminio, aleado > 12 % Si		230	115	0,120
N2	N2.1 Cobre, no aleado y de baja aleación	< 300	180	90	0,120
	N2.2 Cobre, aleado	> 300	180	90	0,120
	N2.3 Latón, bronce, fundición roja	< 1200	180	90	0,120

Los valores de corte indicados son de referencia.

Los datos óptimos para cada situación de mecanizado deben determinarse mediante ensayos o durante el propio proceso de mecanizado.



Sistema EasyAdjust

Ajuste sencillo de herramientas en un tiempo mínimo

La reducción significativa del esfuerzo de ajuste en las herramientas con tecnología de guías de apoyo fue el objetivo del desarrollo del sistema EasyAdjust.

La pieza central del sistema EasyAdjust es un innovador cartucho, que aloja los insertos reversibles de seis o cuatro filos sin holgura y de forma estable. El estrechamiento del filo secundario ya se encuentra integrado en el cartucho, quedando eliminado este esfuerzo de ajuste.

Mediante el guiado exacto del cartucho sobre un pasador de guiado de precisión, el estrechamiento se mantiene sin modificación también durante el ajuste del diámetro. Los car-

tuchos adecuados están disponibles para diferentes estrechamientos. Se pueden seleccionar y utilizar en función de la aplicación, con independencia del inserto de corte y de la herramienta.

Ventajas económicas considerables

En la práctica, este sistema ofrece las siguientes ventajas económicas: los insertos de corte HX con seis filos de corte útiles pueden montarse de forma rápida y precisa en cartuchos con diferentes estrechamientos. En las herramientas con sistema EasyAdjust tan solo hay que ajustar el diámetro. De este modo aumenta la seguridad en el proceso durante el cambio de insertos. Un efecto que aumenta con el incremento del número de insertos monta-

dos en una herramienta. Gracias a este nuevo desarrollo, el tiempo requerido para el esfuerzo de ajuste por inserto queda reducido a una fracción.

VENTAJAS

- El ajuste cuesta muchísimo menos
- Solo es necesario ajustar el diámetro de las herramientas
- Rentabilidad, facilidad de manipulación y seguridad en el proceso significativamente incrementadas en comparación con las herramientas con guías de apoyo sin sistema EA
- Precisión permanentemente alta

Vista general del sistema

Sistema EasyAdjust al detalle

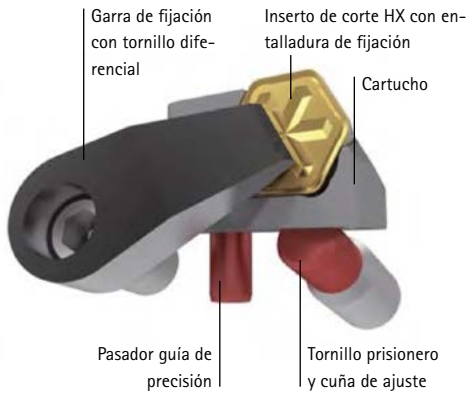

El sistema EasyAdjust consta de un cartucho de precisión en el que se aloja el inserto de corte. Durante el ajuste, el cartucho es guiado a través de un pasador guía de precisión. La sujeción segura del inserto de corte queda garantizada por una entalladura de fijación que, junto con la garra de fijación, forma un sistema estable en arrastre de fuerza.

En las herramientas con sistema EasyAdjust tan solo hay que ajustar el diámetro. El estrechamiento ya se encuentra integrado en el cartucho y permanece inalterado durante los cambios de diámetro.

VENTAJAS

- Tiempo de ajuste reducido a la mitad
- Conducción exacta del sistema sobre el pasador guía de precisión
- Estrechamiento integrado en el cartucho
- Aprovechamiento óptimo del material de corte mediante insertos de corte de cuatro y seis filos

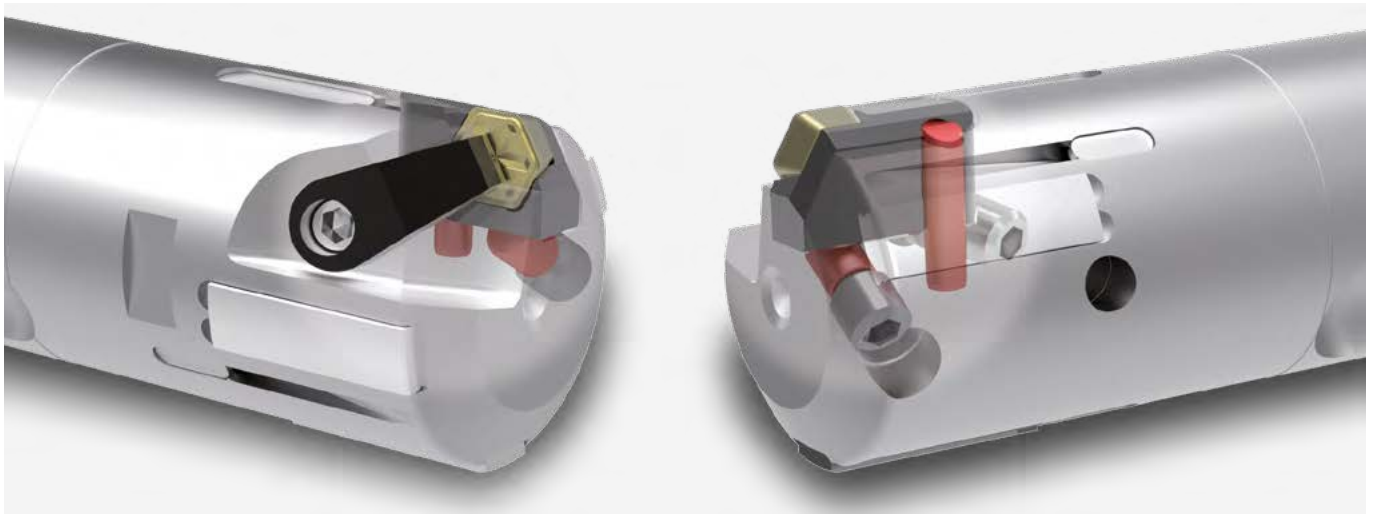

Comparación de los tiempos de ajuste

El ajuste requiere mucho menos tiempo por cada inserto gracias al sistema EasyAdjust.

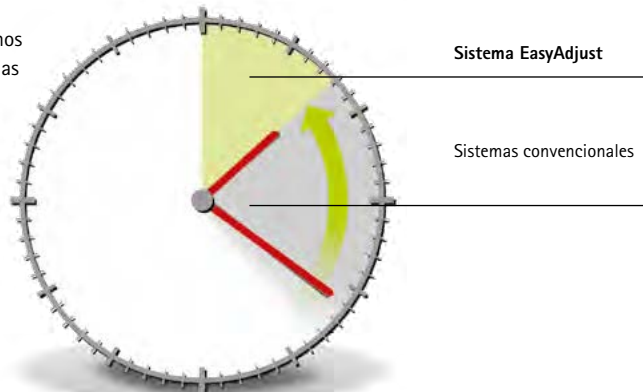

Estrechamiento del filo

El estrechamiento del inserto influye de forma esencial en la calidad del agujero. De acuerdo con las exigencias del material y del avance, MAPAL selecciona el estrechamiento del filo del cartucho requerido para el respectivo caso de mecanizado.

VENTAJAS

- Adaptación del estrechamiento con independencia del inserto de corte y del cuerpo de la herramienta
- Generación de rugosidades definidas mediante diferentes estrechamientos
- Acabado óptimo de la superficie para procesos posteriores (por ejemplo, para el bruñido)

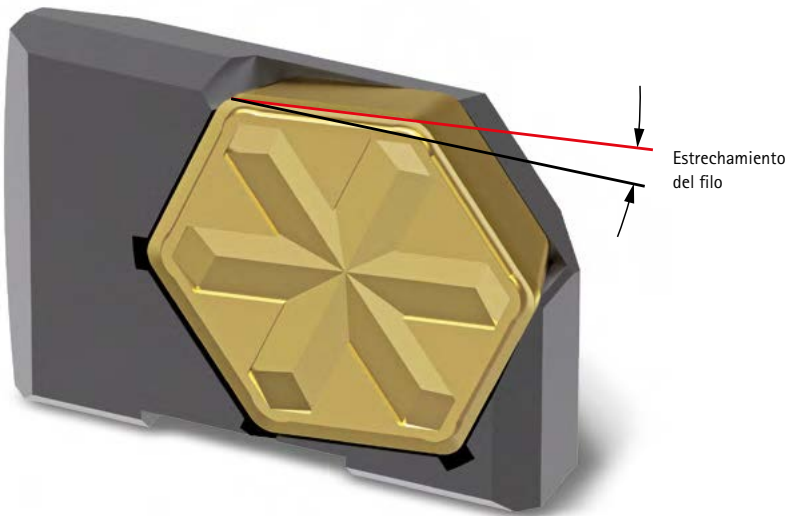

Dos variantes de insertos de corte

El sistema EasyAdjust se ofrece con dos tipos de inserto diferentes para agujeros pasantes y agujeros ciegos:

Inserto de corte HX

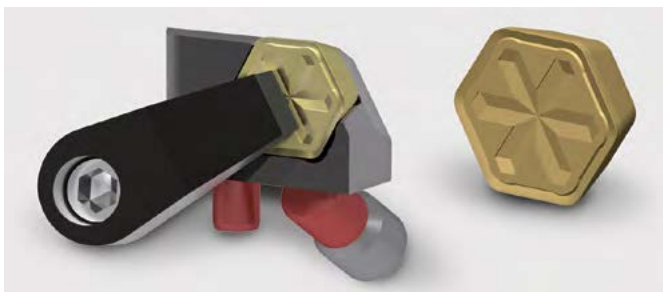

Inserto de corte HX con seis filos de corte para un agujeros pasantes.

Inserto de corte TEC



Inserto de corte TEC con cuatro filos de corte y diferentes geometrías de entrada para agujeros ciegos y para el mecanizado de agujeros de fondo de cara plana.



Agujero pasante

Adecuado para agujeros abiertos. No adecuado para el mecanizado de caras planas cuando se requieren 90°.





Agujero ciego y agujero de fondo de cara plana

Adecuado para agujeros cerrados y para el mecanizado de caras planas, teniendo en cuenta la longitud del filo de corte.

Visión general de la selección





Sistema EasyAdjust con insertos de corte HX

Criterios de selección					Tipo de inserto
Tipo de agujero	Rango de Ø Herramienta	i	Graduación del estrechamiento*	Estrechamiento	
Agujero pasante 	desde ø 20	B	Requisitos especiales	Estrechamiento - ↓ +	HX 
		D	Estándar recomendado		
		F	Requisitos especiales		
		H			
		K			
		M			
		P			
		R			
	desde ø 30	B	Requisitos especiales	Estrechamiento - ↓ +	
		D	Estándar recomendado		
		F	Requisitos especiales		
		H			
		K			
		M			
P					
R					

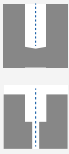

Sistema EasyAdjust con insertos de corte TEC

Criterios de selección					Tipo de inserto
Tipo de agujero	Rango de Ø Herramienta	i	Graduación del estrechamiento*	Estrechamiento	
Agujero ciego/cara plana 	desde ø 20	B	Requisitos especiales	Estrechamiento - ↓ +	TEC 
		D	Estándar recomendado		
		F	Requisitos especiales		
		H			
		K			
		M			
		P			
		R			
	desde ø 30	B	Requisitos especiales	Estrechamiento - ↓ +	
		D	Estándar recomendado		
		F	Requisitos especiales		
		H			
		K			
		M			
P					
R					

Medidas en mm.

Para los insertos de corte adecuados, véase la página 518.

*Selección dependiendo de los requisitos de la pieza, previa consulta con MAPAL.

Nota:

Al cambiar el sistema, asegurarse de que el cartucho y la plaquita de sujeción se adaptan adecuadamente.

Insertos de corte HX para el mecanizado de agujeros

Para herramientas con guías de apoyo

Material de corte			Metal duro								
Grupo de arranque de virutas de Mapal*			P	M	K	N					
Clase de materiales de corte			1.1 - 1.2	2 - 3 5	4 6	1 - 3	1.1	2 - 3	1.1 - 1.2	2.3	2.1 - 2.2
			HP342	HP122	HP018	HP018	HC419	HP122	HP612	HU612	
Geometría de forma de viruta	Tamaño Entrada	Especificación	Referencia								
negativo	2	R0,8	WP-K1288-2133-...								
	3	R0,8	WP-K1288-2123-...								
Neutra	2	R0,8	WP-606087689-...				30688944				
	3	R0,8	WP-606087714-...				30688981				
positivo	2	R0,8	WP-HX228RL-...	30685704	30197811	31100892	31100892		30197811		30320977
	3	R0,8	WP-HX238RL-...	30685705	30669024	31100893	31100893		30669024		30669021
muy positivo	2	R0,8	WP-HX128RL-...							30685707	30669011
	3	R0,8	WP-HX138RL-...							30685708	30669015



Metal duro		Cermet	PCD	PcBN	
S	H	P	N	K	H
1 - 2	1.1	1 - 3 5	1 - 2	1.1	1.1 - 1.2
HU612	HP018	CP122	PU620	FU485	FU801
Referencia		Referencia	Referencia	Referencia	
				30009396**	30033403**
				30008170**	30097476**
	31100892	30222667	31290969**		
	31100893	30222666	31290980**		
	30669011				
	30669015				

Para la recomendación de valores de corte, véase al final del capítulo.
A petición, los insertos están disponibles con entrada especial.

Insertos de corte TEC para el mecanizado de agujeros

Para herramientas con guías de apoyo

Material de corte	Metal duro									
Grupo de arranque de virutas de Mapal*	P				M	K	N			
	1.1 - 1.2	2 - 3 5	4 6	1 - 3	1.1	2 - 3	1.1 - 1.2	2.3	2.1 - 2.2	
Clase de materiales de corte	HP115	HP425	HP016	HP016	HC418	HP426	HP612	HU615		

Geometría de forma de viruta	Tamaño	Entrada	Especificación	Referencia								
negativo	2	AS	WP-TEC2-ASS35R0A-...									
		** EK	WP-TEC2-EKS35R0A-...									
		DZ	WP-TEC2-DZS35R0A-...									
		** R0,4	WP-TEC2-04S35R0A-...									

Neutra	2	AS	WP-TEC2-ASE02R0A-...									
		** EK	WP-TEC2-EKE02R0A-...									
		DZ	WP-TEC2-DZE02R0A-...					31306739				
		** R0,4	WP-TEC2-04E02R0A-...					31306750				

positivo	2	AS	WP-TEC2-ASF01R1G-...	31099198	30953115	31099199	31099199				31306751	
		** EK	WP-TEC2-EKF01R1G-...	31306755	31306756	31306758	31306758				31306761	
		DZ	WP-TEC2-DZF01R1G-...	31306854	31100514	31100517	31100517		31306855		31306857	
		** R0,4	WP-TEC2-04F01R1J-...	31306873	31306875	31306876	31306876		31306878		31306879	

muy positivo	2	AS	WP-TEC2-ASF01R1N-...							31306883	31306887
		** EK	WP-TEC2-EKF01R1N-...							31306903	31306904
		DZ	WP-TEC2-DZF01R1N-...							31306907	31306920
		** R0,4	WP-TEC2-04F01R1U-...							30685231	31306921

** Nota: Utilizar únicamente las entradas EK y R0,4 para el mecanizado de agujeros ciegos y el planeado relacionado con los componentes



Metal duro		
S		H
1 - 2		1.1
HU615		HP016

Cermet	
P	
1 - 3 5	
CP122	

PCD	
N	
1 - 2	
PU620	

PcBN		
K		H
1.1		1.1 - 1.2
FU485		FU801

Referencia		

Referencia	

Referencia	

Referencia		
31306734**		31306735**
30539027**		30688967**

		31100517
		31306876

31306753	
31306762	
31306870	
31306880	

31306754**	
31306763**	
31306871**	
30823892**	

31306887		
31306904		
31306920		
31306921		

Recomendación de valores de corte a petición.
A petición, los insertos están disponibles con entrada especial.

Accesorios para el sistema EasyAdjust



Tamaño de inserto TEC	Cartuchos de cuchilla para sistema EasyAdjust		Placas de apriete para sistema EasyAdjust	
	Especificación	Referencia	Especificación	Referencia
2	BC-EAS-R-42-B	30546828	CP-EAS-R-N2-B	30508276
2	BC-EAS-R-42-D	30498068	CP-EAS-R-N2-D	30561484
2	BC-EAS-R-42-F	30503101	CP-EAS-R-N2-F	30561485
2	BC-EAS-R-42-H	30503104	CP-EAS-R-N2-H	30561487
2	BC-EAS-R-42-K	30546837	CP-EAS-R-N2-K	30561488
2	BC-EAS-R-42-M	30546839	CP-EAS-R-N2-M	30561489
2	BC-EAS-R-42-P	30546840	CP-EAS-R-N2-P	30561490
2	BC-EAS-R-42-R	30546841	CP-EAS-R-N2-R	30508277
3	BC-EAS-R-43-B	30546844	CP-EAS-R-N3-B	30561492
3	BC-EAS-R-43-D	30498067	CP-EAS-R-N3-D	30561493
3	BC-EAS-R-43-F	30503115	CP-EAS-R-N3-F	30561494
3	BC-EAS-R-43-H	30503116	CP-EAS-R-N3-H	30561495
3	BC-EAS-R-43-K	30546845	CP-EAS-R-N3-K	30561496
3	BC-EAS-R-43-M	30546846	CP-EAS-R-N3-M	30561497
3	BC-EAS-R-43-P	30546848	CP-EAS-R-N3-P	30561498
3	BC-EAS-R-43-R	30546849	CP-EAS-R-N3-R	30561499

Nota:

Al cambiar el sistema, asegurarse de que el cartucho y la plaquita de sujeción se adaptan adecuadamente.



Tamaño de inserto HX	Cartuchos de cuchilla para sistema EasyAdjust		Placas de apriete para sistema EasyAdjust	
	Especificación	Referencia	Especificación	Referencia
2	BC-EAS-R-62-B	30275903	CP-EAS-R-N2-B	30508276
2	BC-EAS-R-62-D	30410077	CP-EAS-R-N2-D	30561484
2	BC-EAS-R-62-F	30503094	CP-EAS-R-N2-F	30561485
2	BC-EAS-R-62-H	30503096	CP-EAS-R-N2-H	30561487
2	BC-EAS-R-62-K	30496821	CP-EAS-R-N2-K	30561488
2	BC-EAS-R-62-M	30471831	CP-EAS-R-N2-M	30561489
2	BC-EAS-R-62-P	30471833	CP-EAS-R-N2-P	30561490
2	BC-EAS-R-62-R	30496828	CP-EAS-R-N2-R	30508277
3	BC-EAS-R-63-B	30495992	CP-EAS-R-N3-B	30561492
3	BC-EAS-R-63-D	30469856	CP-EAS-R-N3-D	30561493
3	BC-EAS-R-63-F	30503097	CP-EAS-R-N3-F	30561494
3	BC-EAS-R-63-H	30503098	CP-EAS-R-N3-H	30561495
3	BC-EAS-R-63-K	30496827	CP-EAS-R-N3-K	30561496
3	BC-EAS-R-63-M	30471832	CP-EAS-R-N3-M	30561497
3	BC-EAS-R-63-P	30471834	CP-EAS-R-N3-P	30561498
3	BC-EAS-R-63-R	30496829	CP-EAS-R-N3-R	30561499

Recomendación de valores de corte para insertos de corte HX

Avance y velocidad de corte

HX-HP342

Grupo de arranque de virutas de Mapal*	Material	Rigidez/dureza [N/mm ²] [HRC]	Velocidad de corte v _c (m/min)		Avance f _z (mm/z)	
			Refrigeración interna	Refrigeración exterior		
P P1	P1.1	Aceros de construcción, para tornos automáticos, de cementación y revenidos, no aleados	< 700	80	40	0,150
	P1.2	Aceros de construcción, para tornos automáticos, de cementación y revenidos, no aleados	< 1200	70	35	0,150

HX-HP122

Grupo de arranque de virutas de Mapal*	Material	Rigidez/dureza [N/mm ²] [HRC]	Velocidad de corte v _c (m/min)		Avance f _z (mm/z)		
			Refrigeración interna	Refrigeración exterior			
P P2	P2.1	Aceros nitrurados, de cementación y aceros revenidos, aleados	< 900	100	50	0,150	
	P2.2	Aceros nitrurados, de cementación y aceros revenidos, aleados	< 1400	80	40	0,150	
	P3	P3.1	Aceros para herramientas, rodamientos, resortes y rápidos**	< 900	100	50	0,150
		P3.2	Aceros para herramientas, rodamientos, resortes y rápidos**	< 1500	80	40	0,150
	P5	P5.1	Fundición de acero		80	40	0,150

HX-HP018

Grupo de arranque de virutas de Mapal*	Material	Rigidez/dureza [N/mm ²] [HRC]	Velocidad de corte v _c (m/min)		Avance f _z (mm/z)		
			Refrigeración interna	Refrigeración exterior			
P4 P6	P4.1	Aceros inoxidables, ferríticos y martensíticos		50	25	0,120	
	P6.1	Fundición de acero inoxidable, ferrítica y martensítica		40	20	0,120	
M	M1	M1.1	Aceros inoxidables, austeníticos	< 700	50	25	0,120
		M1.2	Aceros inoxidables, ferríticos/austeníticos (dúplex)	< 1000	30	15	0,120
	M3	M2.1	Fundición de acero inoxidable, austenítica	< 700	50	25	0,120
		M3.1	Fundición de acero inoxidable, ferrítica/austenítica (dúplex)	< 1000	30	15	0,120

HX-HC419

Grupo de arranque de virutas de Mapal*	Material	Rigidez/dureza [N/mm ²] [HRC]	Velocidad de corte v _c (m/min)		Avance f _z (mm/z)	
			Refrigeración interna	Refrigeración exterior		
K K1	K1.1	Hierro fundido con grafito laminar (fundición gris), GJL	< 300	110	55	0,150

* Grupos de mecanizado MAPAL

** Si los componentes de aleación de Cr, Mo, Ni, V, W suman > 8 %, elegir el siguiente grupo de mecanizado MAPAL superior.

HX-HP122

Grupo de arranque de virutas de Mapal*	Material	Rigidez/dureza [N/mm ²] [HRC]	Velocidad de corte v _c (m/min)		Avance f _z (mm/z)
			Refrigeración interna	Refrigeración exterior	
K2	K2.1 Hierro fundido con grafito esferoidal, GJS	< 500	100	50	0,150
	K2.2 Hierro fundido con grafito esferoidal, GJS	≤ 800	90	45	0,150
	K2.3 Hierro fundido con grafito esferoidal, GJS	> 800	80	40	0,150
K3	K3.1 Hierro fundido con grafito vermicular, GJV; fundición maleable, GJM	< 500	70	35	0,150
	K3.2 Hierro fundido con grafito vermicular, GJV; fundición maleable, GJM	> 500	70	35	0,150

HX-HP612

Grupo de arranque de virutas de Mapal*	Material	Rigidez/dureza [N/mm ²] [HRC]	Velocidad de corte v _c (m/min)		Avance f _z (mm/z)
			Refrigeración interna	Refrigeración exterior	
N N1	N1.1 Aluminio, aleado y no aleado < 3 % Si		160	80	0,150
	N1.2 Aluminio, aleado ≤ 7 % Si		160	80	0,150

HX-HU612

Grupo de arranque de virutas de Mapal*	Material	Rigidez/dureza [N/mm ²] [HRC]	Velocidad de corte v _c (m/min)		Avance f _z (mm/z)
			Refrigeración interna	Refrigeración exterior	
N N2	N2.1 Cobre, no aleado y de baja aleación	< 300	100	50	0,150
	N2.2 Cobre, aleado	> 300	100	50	0,150
	N2.3 Latón, bronce, fundición roja	< 1200	100	50	0,150
S S1 S2	S1.1 Titanio, aleaciones de titanio	< 400	30	15	0,120
	S2.1 Titanio, aleaciones de titanio	< 1200	20	10	0,120
	S2.2 Titanio, aleaciones de titanio	> 1200	20	10	0,100

HX-HP018

Grupo de arranque de virutas de Mapal*	Material	Rigidez/dureza [N/mm ²] [HRC]	Velocidad de corte v _c (m/min)		Avance f _z (mm/z)
			Refrigeración interna	Refrigeración exterior	
H H1 H1.1	Acero templado/fundición de acero	45 - 55	30	15	0,120

Los valores de corte indicados son de referencia.

Los datos óptimos para cada situación de mecanizado deben determinarse mediante ensayos o durante el propio proceso de mecanizado.

Recomendación de valores de corte para insertos de corte HX

Avance y velocidad de corte

HX-CP122

Grupo de arranque de virutas de Mapal*	Material	Rigidez/dureza [N/mm ²] [HRC]	Velocidad de corte v _c (m/min)		Avance f _z (mm/z)	
			Refrigeración interna	Refrigeración exterior		
P	P1.1	Aceros de construcción, para tornos automáticos, de cementación y revenidos, no aleados	< 700	180	90	0,150
	P1.2	Aceros de construcción, para tornos automáticos, de cementación y revenidos, no aleados	< 1200	160	80	0,120
	P2.1	Aceros nitrurados, de cementación y aceros revenidos, aleados	< 900	160	80	0,150
	P2.2	Aceros nitrurados, de cementación y aceros revenidos, aleados	< 1400	140	70	0,120
	P3.1	Aceros para herramientas, rodamientos, resortes y rápidos**	< 800	160	80	0,150
	P3.2	Aceros para herramientas, rodamientos, resortes y rápidos**	< 1000	160	80	0,150
	P3.3	Aceros para herramientas, rodamientos, resortes y rápidos**	< 1500	140	70	0,120
	P5.1	Fundición de acero		140	70	0,120

HX-PU620

Grupo de arranque de virutas de Mapal*	Material	Rigidez/dureza [N/mm ²] [HRC]	Velocidad de corte v _c (m/min)		Avance f _z (mm/z)	
			Refrigeración interna	Refrigeración exterior		
N1	N1.1	Aluminio, aleado y no aleado < 3 % Si		230	115	0,150
	N1.2	Aluminio, aleado ≤ 7 % Si		230	115	0,150
	N1.3	Aluminio, aleado > 7-12 % Si		230	115	0,150
	N1.4	Aluminio, aleado > 12 % Si		230	115	0,150
N2	N2.1	Cobre, no aleado y de baja aleación	< 300	180	90	0,150
	N2.2	Cobre, aleado	> 300	180	90	0,150
	N2.3	Latón, bronce, fundición roja	< 1200	180	90	0,150

HX-FU485

Grupo de arranque de virutas de Mapal*	Material	Rigidez/dureza [N/mm ²] [HRC]	Velocidad de corte v _c (m/min)		Avance f _z (mm/z)	
			Refrigeración interna	Refrigeración exterior		
K K1	K1.1	Hierro fundido con grafito laminar (fundición gris), GJL	< 300	150	75	0,150

HX-FU801

Grupo de arranque de virutas de Mapal*	Material	Rigidez/dureza [N/mm ²] [HRC]	Velocidad de corte v _c (m/min)		Avance f _z (mm/z)	
			Refrigeración interna	Refrigeración exterior		
H H1	H1.1	Acero templado/fundición de acero	45 - 55	60	30	0,100
	H1.2	Acero templado/fundición de acero	55 - 64	50	25	0,080

* Grupos de mecanizado MAPAL

** Si los componentes de aleación de Cr, Mo, Ni, V, W suman > 8 %, elegir el siguiente grupo de mecanizado MAPAL superior.

Recomendación de valores de corte para insertos de corte TEC

Avance y velocidad de corte

TEC2-AS-HP115

Grupo de arranque de virutas de Mapal*	Material	Rigidez/dureza [N/mm ²] [HRC]	Velocidad de corte v _c (m/min)		Avance f _z (mm/z)	
			Refrigeración interna	Refrigeración exterior		
P P1	P1.1	Aceros de construcción, para tornos automáticos, de cementación y revenidos, no aleados	< 700	80	40	0,150
	P1.2	Aceros de construcción, para tornos automáticos, de cementación y revenidos, no aleados	< 1200	70	35	0,150

TEC2-EK-HP115

Grupo de arranque de virutas de Mapal*	Material	Rigidez/dureza [N/mm ²] [HRC]	Velocidad de corte v _c (m/min)		Avance f _z (mm/z)	
			Refrigeración interna	Refrigeración exterior		
P P1	P1.1	Aceros de construcción, para tornos automáticos, de cementación y revenidos, no aleados	< 700 N/mm ²	80	40	0,150
	P1.2	Aceros de construcción, para tornos automáticos, de cementación y revenidos, no aleados	< 1200 N/mm ²	70	35	0,150

TEC2-DZ-HP115

Grupo de arranque de virutas de Mapal*	Material	Rigidez/dureza [N/mm ²] [HRC]	Velocidad de corte v _c (m/min)		Avance f _z (mm/z)	
			Refrigeración interna	Refrigeración exterior		
P P1	P1.1	Aceros de construcción, para tornos automáticos, de cementación y revenidos, no aleados	< 700	80	40	0,150
	P1.2	Aceros de construcción, para tornos automáticos, de cementación y revenidos, no aleados	< 1200	70	35	0,150

TEC2-04-HP115

Grupo de arranque de virutas de Mapal*	Material	Rigidez/dureza [N/mm ²] [HRC]	Velocidad de corte v _c (m/min)		Avance f _z (mm/z)	
			Refrigeración interna	Refrigeración exterior		
P P1	P1.1	Aceros de construcción, para tornos automáticos, de cementación y revenidos, no aleados	< 700	80	40	0,150
	P1.2	Aceros de construcción, para tornos automáticos, de cementación y revenidos, no aleados	< 1200	70	35	0,150

TEC2-AS-HP425

Grupo de arranque de virutas de Mapal*	Material	Rigidez/dureza [N/mm ²] [HRC]	Velocidad de corte v _c (m/min)		Avance f _z (mm/z)	
			Refrigeración interna	Refrigeración exterior		
P P2 P3 P5	P2.1	Aceros nitrurados, de cementación y aceros revenidos, aleados	< 900	100	50	0,150
	P2.2	Aceros nitrurados, de cementación y aceros revenidos, aleados	< 1400	80	40	0,150
	P3.1	Aceros para herramientas, rodamientos, resortes y rápidos**	< 900	100	50	0,150
	P3.2	Aceros para herramientas, rodamientos, resortes y rápidos**	< 1500	80	40	0,150
	P5.1	Fundición de acero		80	40	0,150

Los valores de corte indicados son de referencia.

Los datos óptimos para cada situación de mecanizado deben determinarse mediante ensayos o durante el propio proceso de mecanizado.

Recomendación de valores de corte para insertos de corte TEC

Avance y velocidad de corte

TEC2-EK-HP425

Grupo de arranque de virutas de Mapal*	Material	Rigidez/dureza [N/mm ²] [HRC]	Velocidad de corte v _c (m/min)		Avance f _z (mm/z)	
			Refrigeración interna	Refrigeración exterior		
P	P2.1	Aceros nitrurados, de cementación y aceros revenidos, aleados	< 900	100	50	0,150
	P2.2	Aceros nitrurados, de cementación y aceros revenidos, aleados	< 1400	80	40	0,150
	P3.1	Aceros para herramientas, rodamientos, resortes y rápidos**	< 900	100	50	0,150
	P3.2	Aceros para herramientas, rodamientos, resortes y rápidos**	< 1500	80	40	0,150
	P5.1	Fundición de acero		80	40	0,150

TEC2-DZ-HP425

Grupo de arranque de virutas de Mapal*	Material	Rigidez/dureza [N/mm ²] [HRC]	Velocidad de corte v _c (m/min)		Avance f _z (mm/z)	
			Refrigeración interna	Refrigeración exterior		
P	P2.1	Aceros nitrurados, de cementación y aceros revenidos, aleados	< 900	100	50	0,150
	P2.2	Aceros nitrurados, de cementación y aceros revenidos, aleados	< 1400	80	40	0,150
	P3.1	Aceros para herramientas, rodamientos, resortes y rápidos**	< 900	100	50	0,150
	P3.2	Aceros para herramientas, rodamientos, resortes y rápidos**	< 1500	80	40	0,150
	P5.1	Fundición de acero		80	40	0,150

TEC2-04-HP425

Grupo de arranque de virutas de Mapal*	Material	Rigidez/dureza [N/mm ²] [HRC]	Velocidad de corte v _c (m/min)		Avance f _z (mm/z)	
			Refrigeración interna	Refrigeración exterior		
P	P2.1	Aceros nitrurados, de cementación y aceros revenidos, aleados	< 900	100	50	0,150
	P2.2	Aceros nitrurados, de cementación y aceros revenidos, aleados	< 1400	80	40	0,150
	P3.1	Aceros para herramientas, rodamientos, resortes y rápidos**	< 900	100	50	0,150
	P3.2	Aceros para herramientas, rodamientos, resortes y rápidos**	< 1500	80	40	0,150
	P5.1	Fundición de acero		80	40	0,150

TEC2-AS-HP016

Grupo de arranque de virutas de Mapal*	Material	Rigidez/dureza [N/mm ²] [HRC]	Velocidad de corte v _c (m/min)		Avance f _z (mm/z)	
			Refrigeración interna	Refrigeración exterior		
P4	P4.1	Aceros inoxidables, ferríticos y martensíticos		50	25	0,120
	P6.1	Fundición de acero inoxidable, ferrítica y martensítica		40	20	0,120
M	M1.1	Aceros inoxidables, austeníticos	< 700	50	25	0,120
	M1.2	Aceros inoxidables, ferríticos/austeníticos (dúplex)	< 1000	30	15	0,120
	M2.1	Fundición de acero inoxidable, austenítica	< 700	50	25	0,120
M3	M3.1	Fundición de acero inoxidable, ferrítica/austenítica (dúplex)	< 1000	30	15	0,120

* Grupos de mecanizado MAPAL

** Si los componentes de aleación de Cr, Mo, Ni, V, W suman > 8 %, elegir el siguiente grupo de mecanizado MAPAL superior.

TEC2-EK-HP016

Grupo de arranque de virutas de Mapal*	Material	Rigidez/dureza [N/mm ²] [HRC]	Velocidad de corte v _c (m/min)		Avance f _z (mm/z)
			Refrigeración interna	Refrigeración exterior	
P4	P4.1	Aceros inoxidables, ferríticos y martensíticos	50	25	0,120
P6	P6.1	Fundición de acero inoxidable, ferrítica y martensítica	40	20	0,120
M	M1.1	Aceros inoxidables, austeníticos	< 700	50	0,120
	M1.2	Aceros inoxidables, ferríticos/austeníticos (dúplex)	< 1000	30	0,120
	M2.1	Fundición de acero inoxidable, austenítica	< 700	50	0,120
	M3.1	Fundición de acero inoxidable, ferrítica/austenítica (dúplex)	< 1000	30	0,120

TEC2-DZ-HP016

Grupo de arranque de virutas de Mapal*	Material	Rigidez/dureza [N/mm ²] [HRC]	Velocidad de corte v _c (m/min)		Avance f _z (mm/z)
			Refrigeración interna	Refrigeración exterior	
P4	P4.1	Aceros inoxidables, ferríticos y martensíticos	50	25	0,120
P6	P6.1	Fundición de acero inoxidable, ferrítica y martensítica	40	20	0,120
M	M1.1	Aceros inoxidables, austeníticos	< 700	50	0,120
	M1.2	Aceros inoxidables, ferríticos/austeníticos (dúplex)	< 1000	30	0,120
	M2.1	Fundición de acero inoxidable, austenítica	< 700	50	0,120
	M3.1	Fundición de acero inoxidable, ferrítica/austenítica (dúplex)	< 1000	30	0,120

TEC2-04-HP016

Grupo de arranque de virutas de Mapal*	Material	Rigidez/dureza [N/mm ²] [HRC]	Velocidad de corte v _c (m/min)		Avance f _z (mm/z)
			Refrigeración interna	Refrigeración exterior	
P4	P4.1	Aceros inoxidables, ferríticos y martensíticos	50	25	0,120
P6	P6.1	Fundición de acero inoxidable, ferrítica y martensítica	40	20	0,120
M	M1.1	Aceros inoxidables, austeníticos	< 700	50	0,120
	M1.2	Aceros inoxidables, ferríticos/austeníticos (dúplex)	< 1000	30	0,120
	M2.1	Fundición de acero inoxidable, austenítica	< 700	50	0,120
	M3.1	Fundición de acero inoxidable, ferrítica/austenítica (dúplex)	< 1000	30	0,120

TEC2-DZ-HC418

Grupo de arranque de virutas de Mapal*	Material	Rigidez/dureza [N/mm ²] [HRC]	Velocidad de corte v _c (m/min)		Avance f _z (mm/z)		
			Refrigeración interna	Refrigeración exterior			
K	K1	K1.1	Hierro fundido con grafito laminar (fundición gris), GJL	< 300	100	50	0,150

Los valores de corte indicados son de referencia.

Los datos óptimos para cada situación de mecanizado deben determinarse mediante ensayos o durante el propio proceso de mecanizado.

Recomendación de valores de corte para insertos de corte TEC

Avance y velocidad de corte

TEC2-04-HC418

Grupo de arranque de virutas de Mapal*	Material	Rigidez/dureza [N/mm ²] [HRC]	Velocidad de corte v _c (m/min)		Avance f _z (mm/z)
			Refrigeración interna	Refrigeración exterior	
K K1	K1.1 Hierro fundido con grafito laminar (fundición gris), GJL	< 300	100	50	0,150

TEC2-DZ-HP426

Grupo de arranque de virutas de Mapal*	Material	Rigidez/dureza [N/mm ²] [HRC]	Velocidad de corte v _c (m/min)		Avance f _z (mm/z)
			Refrigeración interna	Refrigeración exterior	
K2	K2.1 Hierro fundido con grafito esférico, GJS	< 500	100	50	0,150
	K2.2 Hierro fundido con grafito esférico, GJS	≤ 800	90	45	0,150
	K2.3 Hierro fundido con grafito esférico, GJS	> 800	80	40	0,150
K3	K3.1 Hierro fundido con grafito vermicular, GJV; fundición maleable, GJM	< 500	70	35	0,150
	K3.2 Hierro fundido con grafito vermicular, GJV; fundición maleable, GJM	> 500	70	35	0,150

TEC2-04-HP426

Grupo de arranque de virutas de Mapal*	Material	Rigidez/dureza [N/mm ²] [HRC]	Velocidad de corte v _c (m/min)		Avance f _z (mm/z)
			Refrigeración interna	Refrigeración exterior	
K2	K2.1 Hierro fundido con grafito esférico, GJS	< 500	100	50	0,150
	K2.2 Hierro fundido con grafito esférico, GJS	≤ 800	90	45	0,150
	K2.3 Hierro fundido con grafito esférico, GJS	> 800	80	40	0,150
K3	K3.1 Hierro fundido con grafito vermicular, GJV; fundición maleable, GJM	< 500	70	35	0,150
	K3.2 Hierro fundido con grafito vermicular, GJV; fundición maleable, GJM	> 500	70	35	0,150

TEC2-AS-HP612

Grupo de arranque de virutas de Mapal*	Material	Rigidez/dureza [N/mm ²] [HRC]	Velocidad de corte v _c (m/min)		Avance f _z (mm/z)
			Refrigeración interna	Refrigeración exterior	
N N1	N1.1 Aluminio, aleado y no aleado < 3 % Si		160	80	0,150
	N1.2 Aluminio, aleado ≤ 7 % Si		160	80	0,150

TEC2-EK-HP612

Grupo de arranque de virutas de Mapal*	Material	Rigidez/dureza [N/mm ²] [HRC]	Velocidad de corte v _c (m/min)		Avance f _z (mm/z)
			Refrigeración interna	Refrigeración exterior	
N N1	N1.1 Aluminio, aleado y no aleado < 3 % Si		160	80	0,150
	N1.2 Aluminio, aleado ≤ 7 % Si		160	80	0,150

* Grupos de mecanizado MAPAL

TEC2-DZ-HP612

Grupo de arranque de virutas de Mapal*	Material	Rigidez/dureza [N/mm ²] [HRC]	Velocidad de corte v _c (m/min)		Avance f _z (mm/z)
			Refrigeración interna	Refrigeración exterior	
N N1	N1.1 Aluminio, aleado y no aleado < 3 % Si		160	80	0,150
	N1.2 Aluminio, aleado ≤ 7 % Si		160	80	0,150

TEC2-04-HP612

Grupo de arranque de virutas de Mapal*	Material	Rigidez/dureza [N/mm ²] [HRC]	Velocidad de corte v _c (m/min)		Avance f _z (mm/z)
			Refrigeración interna	Refrigeración exterior	
N N1	N1.1 Aluminio, aleado y no aleado < 3 % Si		160	80	0,150
	N1.2 Aluminio, aleado ≤ 7 % Si		160	80	0,150

TEC2-AS-HU615

Grupo de arranque de virutas de Mapal*	Material	Rigidez/dureza [N/mm ²] [HRC]	Velocidad de corte v _c (m/min)		Avance f _z (mm/z)
			Refrigeración interna	Refrigeración exterior	
N N2	N2.1 Cobre, no aleado y de baja aleación	< 300	100	50	0,150
	N2.2 Cobre, aleado	> 300	100	50	0,150
	N2.3 Latón, bronce, fundición roja	< 1200	100	50	0,150
S S1 S S2	S1.1 Titanio, aleaciones de titanio	< 400	30	15	0,120
	S2.1 Titanio, aleaciones de titanio	< 1200	20	10	0,120
	S2.2 Titanio, aleaciones de titanio	> 1200	20	10	0,100

TEC2-EK-HU615

Grupo de arranque de virutas de Mapal*	Material	Rigidez/dureza [N/mm ²] [HRC]	Velocidad de corte v _c (m/min)		Avance f _z (mm/z)
			Refrigeración interna	Refrigeración exterior	
N N2	N2.1 Cobre, no aleado y de baja aleación	< 300	100	50	0,150
	N2.2 Cobre, aleado	> 300	100	50	0,150
	N2.3 Latón, bronce, fundición roja	< 1200	100	50	0,150
S S1 S S2	S1.1 Titanio, aleaciones de titanio	< 400	30	15	0,120
	S2.1 Titanio, aleaciones de titanio	< 1200	20	10	0,120
	S2.2 Titanio, aleaciones de titanio	> 1200	20	10	0,100

Los valores de corte indicados son de referencia.

Los datos óptimos para cada situación de mecanizado deben determinarse mediante ensayos o durante el propio proceso de mecanizado.

Recomendación de valores de corte para insertos de corte TEC

Avance y velocidad de corte

TEC2-DZ-HU615

Grupo de arranque de virutas de Mapal*			Material	Rigidez/dureza [N/mm ²] [HRC]	Velocidad de corte v _c (m/min)		Avance f _z (mm/z)
					Refrigeración interna	Refrigeración exterior	
N	N2	N2.1	Cobre, no aleado y de baja aleación	< 300	100	50	0,150
		N2.2	Cobre, aleado	> 300	100	50	0,150
		N2.3	Latón, bronce, fundición roja	< 1200	100	50	0,150
S	S2	S2.1	Titanio, aleaciones de titanio	< 400	30	15	0,120
		S2.1	Titanio, aleaciones de titanio	< 1200	20	10	0,120
		S2.2	Titanio, aleaciones de titanio	> 1200	20	10	0,100

TEC2-04-HU615

Grupo de arranque de virutas de Mapal*			Material	Rigidez/dureza [N/mm ²] [HRC]	Velocidad de corte v _c (m/min)		Avance f _z (mm/z)
					Refrigeración interna	Refrigeración exterior	
N	N2	N2.1	Cobre, no aleado y de baja aleación	< 300	100	50	0,150
		N2.2	Cobre, aleado	> 300	100	50	0,150
		N2.3	Latón, bronce, fundición roja	< 1200	100	50	0,150
S	S2	S2.1	Titanio, aleaciones de titanio	< 400	30	15	0,120
		S2.1	Titanio, aleaciones de titanio	< 1200	20	10	0,120
		S2.2	Titanio, aleaciones de titanio	> 1200	20	10	0,100

TEC2-DZ-HP016

Grupo de arranque de virutas de Mapal*			Material	Rigidez/dureza [N/mm ²] [HRC]	Velocidad de corte v _c (m/min)		Avance f _z (mm/z)
					Refrigeración interna	Refrigeración exterior	
H	H1	H1.1	Acero templado/fundición de acero	45 - 55	30	15	0,120

TEC2-04-HP016

Grupo de arranque de virutas de Mapal*			Material	Rigidez/dureza [N/mm ²] [HRC]	Velocidad de corte v _c (m/min)		Avance f _z (mm/z)
					Refrigeración interna	Refrigeración exterior	
H	H1	H1.1	Acero templado/fundición de acero	45 - 55	30	15	0,120

* Grupos de mecanizado MAPAL

** Si los componentes de aleación de Cr, Mo, Ni, V, W suman > 8 %, elegir el siguiente grupo de mecanizado MAPAL superior.

TEC2-AS-CP122

Grupo de arranque de virutas de Mapal*	Material	Rigidez/dureza [N/mm ²] [HRC]	Velocidad de corte v _c (m/min)		Avance f _z (mm/z)	
			Refrigeración interna	Refrigeración exterior		
P	P1.1	Aceros de construcción, para tornos automáticos, de cementación y revenidos, no aleados	< 700	180	90	0,150
	P1.2	Aceros de construcción, para tornos automáticos, de cementación y revenidos, no aleados	< 1200	160	80	0,120
	P2.1	Aceros nitrurados, de cementación y aceros revenidos, aleados	< 900	160	80	0,150
	P2.2	Aceros nitrurados, de cementación y aceros revenidos, aleados	< 1400	140	70	0,120
	P3.1	Aceros para herramientas, rodamientos, resortes y rápidos**	< 800	160	80	0,150
	P3.2	Aceros para herramientas, rodamientos, resortes y rápidos**	< 1000	160	80	0,150
	P3.3	Aceros para herramientas, rodamientos, resortes y rápidos**	< 1500	140	70	0,120
	P5.1	Fundición de acero		140	70	0,120

TEC2-EK-CP122

Grupo de arranque de virutas de Mapal*	Material	Rigidez/dureza [N/mm ²] [HRC]	Velocidad de corte v _c (m/min)		Avance f _z (mm/z)	
			Refrigeración interna	Refrigeración exterior		
P	P1.1	Aceros de construcción, para tornos automáticos, de cementación y revenidos, no aleados	< 700	180	90	0,150
	P1.2	Aceros de construcción, para tornos automáticos, de cementación y revenidos, no aleados	< 1200	160	80	0,120
	P2.1	Aceros nitrurados, de cementación y aceros revenidos, aleados	< 900	160	80	0,150
	P2.2	Aceros nitrurados, de cementación y aceros revenidos, aleados	< 1400	140	70	0,120
	P3.1	Aceros para herramientas, rodamientos, resortes y rápidos**	< 800	160	80	0,150
	P3.2	Aceros para herramientas, rodamientos, resortes y rápidos**	< 1000	160	80	0,150
	P3.3	Aceros para herramientas, rodamientos, resortes y rápidos**	< 1500	140	70	0,120
	P5.1	Fundición de acero		140	70	0,120

TEC2-DZ-CP122

Grupo de arranque de virutas de Mapal*	Material	Rigidez/dureza [N/mm ²] [HRC]	Velocidad de corte v _c (m/min)		Avance f _z (mm/z)	
			Refrigeración interna	Refrigeración exterior		
P	P1.1	Aceros de construcción, para tornos automáticos, de cementación y revenidos, no aleados	< 700	180	90	0,150
	P1.2	Aceros de construcción, para tornos automáticos, de cementación y revenidos, no aleados	< 1200	160	80	0,120
	P2.1	Aceros nitrurados, de cementación y aceros revenidos, aleados	< 900	160	80	0,150
	P2.2	Aceros nitrurados, de cementación y aceros revenidos, aleados	< 1400	140	70	0,120
	P3.1	Aceros para herramientas, rodamientos, resortes y rápidos**	< 800	160	80	0,150
	P3.2	Aceros para herramientas, rodamientos, resortes y rápidos**	< 1000	160	80	0,150
	P3.3	Aceros para herramientas, rodamientos, resortes y rápidos**	< 1500	140	70	0,120
	P5.1	Fundición de acero		140	70	0,120

Los valores de corte indicados son de referencia.

Los datos óptimos para cada situación de mecanizado deben determinarse mediante ensayos o durante el propio proceso de mecanizado.

Recomendación de valores de corte para insertos de corte TEC

Avance y velocidad de corte

TEC2-04-CP122

Grupo de arranque de virutas de Mapal*	Material	Rigidez/dureza [N/mm ²] [HRC]	Velocidad de corte v _c (m/min)		Avance f _z (mm/z)
			Refrigeración interna	Refrigeración exterior	
P1	P1.1 Aceros de construcción, para tornos automáticos, de cementación y revenidos, no aleados	< 700	180	90	0,150
	P1.2 Aceros de construcción, para tornos automáticos, de cementación y revenidos, no aleados	< 1200	160	80	0,120
P2	P2.1 Aceros nitrurados, de cementación y aceros revenidos, aleados	< 900	160	80	0,150
	P2.2 Aceros nitrurados, de cementación y aceros revenidos, aleados	< 1400	140	70	0,120
P3	P3.1 Aceros para herramientas, rodamientos, resortes y rápidos**	< 800	160	80	0,150
	P3.2 Aceros para herramientas, rodamientos, resortes y rápidos**	< 1000	160	80	0,150
	P3.3 Aceros para herramientas, rodamientos, resortes y rápidos**	< 1500	140	70	0,120
P5	P5.1 Fundición de acero		140	70	0,120

TEC2-AS-PU620

Grupo de arranque de virutas de Mapal*	Material	Rigidez/dureza [N/mm ²] [HRC]	Velocidad de corte v _c (m/min)		Avance f _z (mm/z)
			Refrigeración interna	Refrigeración exterior	
N1	N1.1 Aluminio, aleado y no aleado < 3 % Si		230	115	0,150
	N1.2 Aluminio, aleado ≤ 7 % Si		230	115	0,150
	N1.3 Aluminio, aleado > 7-12 % Si		230	115	0,150
	N1.4 Aluminio, aleado > 12 % Si		230	115	0,150
N2	N2.1 Cobre, no aleado y de baja aleación	< 300	180	90	0,150
	N2.2 Cobre, aleado	> 300	180	90	0,150
	N2.3 Latón, bronce, fundición roja	< 1200	180	90	0,150

TEC2-EK-PU620

Grupo de arranque de virutas de Mapal*	Material	Rigidez/dureza [N/mm ²] [HRC]	Velocidad de corte v _c (m/min)		Avance f _z (mm/z)
			Refrigeración interna	Refrigeración exterior	
N1	N1.1 Aluminio, aleado y no aleado < 3 % Si		230	115	0,150
	N1.2 Aluminio, aleado ≤ 7 % Si		230	115	0,150
	N1.3 Aluminio, aleado > 7-12 % Si		230	115	0,150
	N1.4 Aluminio, aleado > 12 % Si		230	115	0,150
N2	N2.1 Cobre, no aleado y de baja aleación	< 300	180	90	0,150
	N2.2 Cobre, aleado	> 300	180	90	0,150
	N2.3 Latón, bronce, fundición roja	< 1200	180	90	0,150

* Grupos de mecanizado MAPAL

** Si los componentes de aleación de Cr, Mo, Ni, V, W suman > 8 %, elegir el siguiente grupo de mecanizado MAPAL superior.

TEC2-DZ-PU620

Grupo de arranque de virutas de Mapal*	Material	Rigidez/dureza [N/mm ²] [HRC]	Velocidad de corte v _c (m/min)		Avance f _z (mm/z)	
			Refrigeración interna	Refrigeración exterior		
N	N1	N1.1 Aluminio, aleado y no aleado < 3 % Si		230	115	0,150
		N1.2 Aluminio, aleado ≤ 7 % Si		230	115	0,150
		N1.3 Aluminio, aleado > 7-12 % Si		230	115	0,150
		N1.4 Aluminio, aleado > 12 % Si		230	115	0,150
N	N2	N2.1 Cobre, no aleado y de baja aleación	< 300	180	90	0,150
		N2.2 Cobre, aleado	> 300	180	90	0,150
		N2.3 Latón, bronce, fundición roja	< 1200	180	90	0,150

TEC2-04-PU620

Grupo de arranque de virutas de Mapal*	Material	Rigidez/dureza [N/mm ²] [HRC]	Velocidad de corte v _c (m/min)		Avance f _z (mm/z)	
			Refrigeración interna	Refrigeración exterior		
N	N1	N1.1 Aluminio, aleado y no aleado < 3 % Si		230	115	0,150
		N1.2 Aluminio, aleado ≤ 7 % Si		230	115	0,150
		N1.3 Aluminio, aleado > 7-12 % Si		230	115	0,150
		N1.4 Aluminio, aleado > 12 % Si		230	115	0,150
N	N2	N2.1 Cobre, no aleado y de baja aleación	< 300	180	90	0,150
		N2.2 Cobre, aleado	> 300	180	90	0,150
		N2.3 Latón, bronce, fundición roja	< 1200	180	90	0,150

Los valores de corte indicados son de referencia.

Los datos óptimos para cada situación de mecanizado deben determinarse mediante ensayos o durante el propio proceso de mecanizado.

Recomendación de valores de corte para insertos de corte TEC

Avance y velocidad de corte

TEC2-DZ-FU485

Grupo de arranque de virutas de Mapal*	Material	Rigidez/dureza [N/mm ²] [HRC]	Velocidad de corte v _c (m/min)		Avance f _z (mm/z)
			Refrigeración interna	Refrigeración exterior	
K K1 K1.1	Hierro fundido con grafito laminar (fundición gris), GJL	< 300	150	75	0,150

TEC2-04-FU485

Grupo de arranque de virutas de Mapal*	Material	Rigidez/dureza [N/mm ²] [HRC]	Velocidad de corte v _c (m/min)		Avance f _z (mm/z)
			Refrigeración interna	Refrigeración exterior	
K K1 K1.1	Hierro fundido con grafito laminar (fundición gris), GJL	< 300	150	75	0,150

TEC2-DZ-FU801

Grupo de arranque de virutas de Mapal*		Material	Rigidez/dureza [N/mm ²] [HRC]	Velocidad de corte v _c (m/min)		Avance f _z (mm/z)
				Refrigeración interna	Refrigeración exterior	
H	H1.1	Acero templado/fundición de acero	45 - 55	60	30	0,100
	H1.2	Acero templado/fundición de acero	55 - 64	50	25	0,080

TEC2-04-FU801

Grupo de arranque de virutas de Mapal*		Material	Rigidez/dureza [N/mm ²] [HRC]	Velocidad de corte v _c (m/min)		Avance f _z (mm/z)
				Refrigeración interna	Refrigeración exterior	
H	H1.1	Acero templado/fundición de acero	45 - 55	60	30	0,100
	H1.2	Acero templado/fundición de acero	55 - 64	50	25	0,080

Los valores de corte indicados son de referencia.

Los datos óptimos para cada situación de mecanizado deben determinarse mediante ensayos o durante el propio proceso de mecanizado.



Manejo sumamente sencillo durante el escariado exterior de pequeños diámetros

Con el fin de simplificar al máximo el ajuste de los escariadores exteriores con diámetros pequeños, MAPAL ha desarrollado un nuevo sistema. A tal efecto, el sistema EasyAdjust va integrado en un cartucho. Este puede desmontarse para ajustar el inserto de forma rápida y sencilla con un tornillo micrométrico o con una placa de medición.

En el propio sistema EA, el estrechamiento del inserto ya está integrado en el alojamiento del inserto, suprimiendo por completo el proceso de ajuste del estrechamiento del inserto secundario. Tan solo es preciso ajustar el saliente del inserto con respecto a las guías de apoyo. Gracias a la elevada precisión de cambio y al ajuste sumamente sencillo del inserto, el cumplimiento seguro de las tolerancias requeridas en los ajustes de alta precisión puede realizarse de manera considerablemente más fácil con el nuevo sistema, incluso en el rango de diámetros pequeños.

RESUMEN

- Nuevo sistema para el ajuste sencillo durante el escariado exterior de pequeños diámetros
- Cartucho del sistema EA integrado en otro cartucho desmontable
- Elevada precisión de cambio (inferior a 2-3 μm)
- El inserto puede ajustarse de forma rápida y sencilla
- El estrechamiento del inserto va integrado en el cartucho que se utiliza para alojar el inserto

VENTAJAS

- Alta rentabilidad y seguridad en el proceso
- Esfuerzo de ajuste reducido mediante innovador cartucho en cartucho
- Manejo sencillo
- El proceso de ajuste para el estrechamiento del inserto secundario se suprime por completo
- Cumplimiento seguro de tolerancias estrechas



Escariador externo con sistema EasyAdjust | Diferenciación del sistema

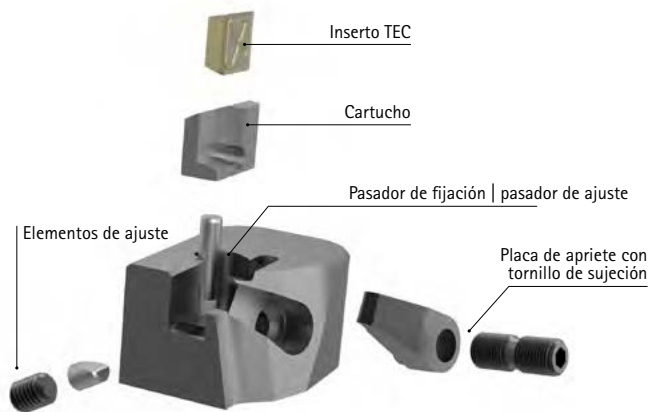

Sistema EasyAdjust con inserto de corte TEC

- Aprovechamiento de todos los filos (número de filos de corte)
- Manejo sencillo
- Posibilidad de insertos TEC2 y TEC3

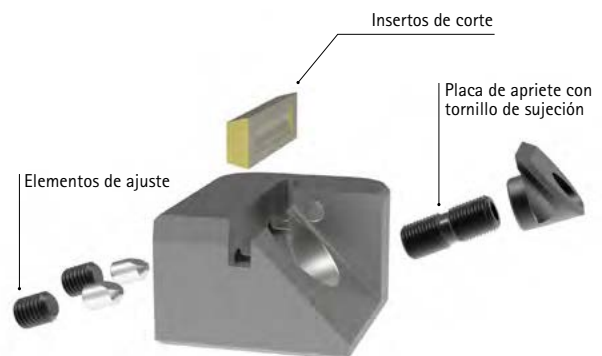

Insertos de corte

- Grandes exigencias en la superficie p. ej. $< R_z 6$
- Contorno especial (insertos de corte)
- Mecanizado de refrentado
- Corte plano con transición de radio

Insertos de corte TEC para herramientas de mecanizado exterior

Material de corte	Metal duro									
Grupo de arranque de virutas de Mapal*	P			M	K	N				
	1.1 - 1.2	2 - 3 5	4 6	1 - 3	1.1	2 - 3	1.1 - 1.2	2.3	2.1 - 2.2	
Clase de materiales de corte	HP115	HP425	HP016	HP016	HC418	HP426	HP612	HU615		

Geometría de forma de viruta	Tamaño	Entrada	Especificación	Referencia								
Neutra	2	AS	WP-TEC2-ASE02LOA-...									
		EK **	WP-TEC2-EKE02LOA-...									
		DZ	WP-TEC2-DZE02LOA-...					31306931				
		R0,4 **	WP-TEC2-04E02LOA-...					31306932				

positivo	2	AS	WP-TEC2-ASF01L1G-...	31306933	30889440	31079651	31079651				31140267	
		EK **	WP-TEC2-EKF01L1G-...	30653470	30829191	30971023	30971023				30630537	
		DZ	WP-TEC2-DZF01L1G-...	31306937	31306938	31306940	31306940		31306941		31181002	
		R0,4 **	WP-TEC2-04F01L1J-...	31306945	31306947	31306949	31306949		31306950		31306951	

muy positivo	2	AS	WP-TEC2-ASF01L1N-...							31306973		31306974
		EK **	WP-TEC2-EKF01L1N-...							31306977		31306978
		DZ	WP-TEC2-DZF01L1N-...							31306979		31306980
		R0,4 **	WP-TEC2-04F01L1U-...							31306981		31306982

** Nota: Utilizar únicamente las entradas EK y R0,4 para el mecanizado de agujeros ciegos y el planeado relacionado con los componentes



Metal duro		
S		H
1 - 2		1.1
HU615		HP016

Cermet	
P	
1 - 3 5	
CP122	

PCD	
N	
1 - 2	
PU620	

PcBN		
K		H
1.1		1.1 - 1.2
FU485		FU801

Referencia		

Referencia	

Referencia	

Referencia		

31301539	
30627301	
31306942	
31307406	

31306934**	
30630446**	
31306943**	
31306953**	

31306974		
31306978		
31306980		
31306982		

Para la recomendación de valores de corte, véase al final del capítulo.
A petición, los insertos están disponibles con entrada especial.

Insertos de corte para herramientas de mecanizado exterior

Material de corte	Metal duro									
Grupo de arranque de virutas de Mapal*	P				M	K	N			
	1.1 - 1.2	2 - 3 5	4 6	1 - 3	1.1	2 - 3	1.1 - 1.2	2.3	2.1 - 2.2	
Clase de materiales de corte	HP115	HP425	HP016	HP016	HC418	HP426	HP612	HU615		

Geometría de forma de viruta	Tamaño	Entrada	Especificación	Referencia								
Neutra	92	AS	WP-AS92L0-...									
		EK	WP-EK152L0-...									
		DZ	WP-DZ92L0-...					31301508				

positivo	92	AS	WP-AS92L6-...	30914125	30914127	31056555	31056555				30914124	
		EK	WP-EK152L6-...	30914554	31302302	31247603	31247603				30914553	
		DZ	WP-DZ92L6-...	31306923	31306925	31306926	31306926		31306927		30914421	

muy positivo	92	AS	WP-AS92L2-...							31175426		30914120
		EK	WP-EK152L2-...							31301535		30914549
		DZ	WP-DZ92L2-...									

Inserto con entrada AS



Inserto con entrada EK



Inserto con entrada DZ



Metal duro		
S		H
1 - 2		1.1
HU615		HP016

Cermet	
P	
1 - 3 5	
CP122	

PCD	
N	
1 - 2	
PU620	

PcBN		
K		H
1.1		1.1 - 1.2
FU485		FU801

Referencia		

Referencia	

Referencia	

Referencia		

30309015	
31301541	
31306928	

30914763**	
30914788**	

30914120		
30914549		

Para la recomendación de valores de corte, véase al final del capítulo.
A petición, los insertos están disponibles con entrada especial.

Accesorios para herramientas de mecanizado exterior



Tamaño de inserto TEC	Cartuchos de cuchilla para herramienta de mecanizado exterior		Placas de apriete para herramienta de mecanizado exterior	
	Especificación	Referencia	Especificación	Referencia
2	BC-EAS-L-42-B	30562954	CP-EAS-L-N2-B	30565468
2	BC-EAS-L-42-D	30558608	CP-EAS-L-N2-D	30560195
2	BC-EAS-L-42-F	30562956	CP-EAS-L-N2-F	30565469
2	BC-EAS-L-42-H	30562958	CP-EAS-L-N2-H	30565470
2	BC-EAS-L-42-K	30562959	CP-EAS-L-N2-K	30565472
2	BC-EAS-L-42-M	30562960	CP-EAS-L-N2-M	30565474
2	BC-EAS-L-42-P	30562963	CP-EAS-L-N2-P	30565475
2	BC-EAS-L-42-R	30562964	CP-EAS-L-N2-R	30565478
3	BC-EAS-L-43-B	30562965	CP-EAS-L-N3-B	30565479
3	BC-EAS-L-43-D	30562967	CP-EAS-L-N3-D	30565481
3	BC-EAS-L-43-F	30562968	CP-EAS-L-N3-F	30565483
3	BC-EAS-L-43-H	30562969	CP-EAS-L-N3-H	30565490
3	BC-EAS-L-43-K	30562970	CP-EAS-L-N3-K	30565491
3	BC-EAS-L-43-M	30562971	CP-EAS-L-N3-M	30565492
3	BC-EAS-L-43-P	30562972	CP-EAS-L-N3-P	30565494
3	BC-EAS-L-43-R	30562974	CP-EAS-L-N3-R	30565495

Nota:

Al cambiar el sistema, asegurarse de que el cartucho y la plaquita de sujeción se adaptan adecuadamente.



Recomendación de valores de corte para herramientas de mecanizado exterior con insertos de corte TEC

Avance y velocidad de corte

TEC2-AS-L-HP115

Grupo de arranque de virutas de Mapal*	Material	Rigidez/dureza [N/mm ²] [HRC]	Velocidad de corte v _c (m/min)	Avance f _z (mm/z)	
			Refrigeración interna		
P P1	P1.1	Aceros de construcción, para tornos automáticos, de cementación y revenidos, no aleados	< 700	80	0,150
	P1.2	Aceros de construcción, para tornos automáticos, de cementación y revenidos, no aleados	< 1200	70	0,150

TEC2-EK-L-HP115

Grupo de arranque de virutas de Mapal*	Material	Rigidez/dureza [N/mm ²] [HRC]	Velocidad de corte v _c (m/min)	Avance f _z (mm/z)	
			Refrigeración interna		
P P1	P1.1	Aceros de construcción, para tornos automáticos, de cementación y revenidos, no aleados	< 700	80	0,150
	P1.2	Aceros de construcción, para tornos automáticos, de cementación y revenidos, no aleados	< 1200	70	0,150

TEC2-DZ-L-HP115

Grupo de arranque de virutas de Mapal*	Material	Rigidez/dureza [N/mm ²] [HRC]	Velocidad de corte v _c (m/min)	Avance f _z (mm/z)	
			Refrigeración interna		
P P1	P1.1	Aceros de construcción, para tornos automáticos, de cementación y revenidos, no aleados	< 700	80	0,150
	P1.2	Aceros de construcción, para tornos automáticos, de cementación y revenidos, no aleados	< 1200	70	0,150

TEC2-04-L-HP115

Grupo de arranque de virutas de Mapal*	Material	Rigidez/dureza [N/mm ²] [HRC]	Velocidad de corte v _c (m/min)	Avance f _z (mm/z)	
			Refrigeración interna		
P P1	P1.1	Aceros de construcción, para tornos automáticos, de cementación y revenidos, no aleados	< 700	80	0,150
	P1.2	Aceros de construcción, para tornos automáticos, de cementación y revenidos, no aleados	< 1200	70	0,150

TEC2-AS-L-HP425

Grupo de arranque de virutas de Mapal*	Material	Rigidez/dureza [N/mm ²] [HRC]	Velocidad de corte v _c (m/min)	Avance f _z (mm/z)	
			Refrigeración interna		
P	P2.1	Aceros nitrurados, de cementación y aceros revenidos, aleados	< 900	100	0,150
	P2.2	Aceros nitrurados, de cementación y aceros revenidos, aleados	< 1400	80	0,150
	P3.1	Aceros para herramientas, rodamientos, resortes y rápidos**	< 900	100	0,150
	P3.2	Aceros para herramientas, rodamientos, resortes y rápidos**	< 1500	80	0,150
	P5.1	Fundición de acero		80	0,150

* Grupos de mecanizado MAPAL

** Si los componentes de aleación de Cr, Mo, Ni, V, W suman > 8 %, elegir el siguiente grupo de mecanizado MAPAL superior.

TEC2-EK-L-HP425

Grupo de arranque de virutas de Mapal*	Material	Rigidez/dureza [N/mm ²] [HRC]	Velocidad de corte v _c (m/min)	Avance f _z (mm/z)	
			Refrigeración interna		
P	P2.1	Aceros nitrurados, de cementación y aceros revenidos, aleados	< 900	100	0,150
	P2.2	Aceros nitrurados, de cementación y aceros revenidos, aleados	< 1400	80	0,150
	P3.1	Aceros para herramientas, rodamientos, resortes y rápidos**	< 900	100	0,150
	P3.2	Aceros para herramientas, rodamientos, resortes y rápidos**	< 1500	80	0,150
	P5.1	Fundición de acero		80	0,150

TEC2-DZ-L-HP425

Grupo de arranque de virutas de Mapal*	Material	Rigidez/dureza [N/mm ²] [HRC]	Velocidad de corte v _c (m/min)	Avance f _z (mm/z)	
			Refrigeración interna		
P	P2.1	Aceros nitrurados, de cementación y aceros revenidos, aleados	< 900	100	0,150
	P2.2	Aceros nitrurados, de cementación y aceros revenidos, aleados	< 1400	80	0,150
	P3.1	Aceros para herramientas, rodamientos, resortes y rápidos**	< 900	100	0,150
	P3.2	Aceros para herramientas, rodamientos, resortes y rápidos**	< 1500	80	0,150
	P5.1	Fundición de acero		80	0,150

TEC2-04-L-HP425

Grupo de arranque de virutas de Mapal*	Material	Rigidez/dureza [N/mm ²] [HRC]	Velocidad de corte v _c (m/min)	Avance f _z (mm/z)	
			Refrigeración interna		
P	P2.1	Aceros nitrurados, de cementación y aceros revenidos, aleados	< 900	100	0,150
	P2.2	Aceros nitrurados, de cementación y aceros revenidos, aleados	< 1400	80	0,150
	P3.1	Aceros para herramientas, rodamientos, resortes y rápidos**	< 900	100	0,150
	P3.2	Aceros para herramientas, rodamientos, resortes y rápidos**	< 1500	80	0,150
	P5.1	Fundición de acero		80	0,150

TEC2-AS-L-HP016

Grupo de arranque de virutas de Mapal*	Material	Rigidez/dureza [N/mm ²] [HRC]	Velocidad de corte v _c (m/min)	Avance f _z (mm/z)
			Refrigeración interna	
P4	P4.1	Aceros inoxidables, ferríticos y martensíticos	50	0,120
P6	P6.1	Fundición de acero inoxidable, ferrítica y martensítica	40	0,120
M	M1.1	Aceros inoxidables, austeníticos	50	0,120
	M1.2	Aceros inoxidables, ferríticos/austeníticos (dúplex)	30	0,120
	M2.1	Fundición de acero inoxidable, austenítica	50	0,120
	M3.1	Fundición de acero inoxidable, ferrítica/austenítica (dúplex)	30	0,120

Los valores de corte indicados son de referencia.

Los datos óptimos para cada situación de mecanizado deben determinarse mediante ensayos o durante el propio proceso de mecanizado.

Recomendación de valores de corte para herramientas de mecanizado exterior con insertos de corte TEC

Avance y velocidad de corte

TEC2-EK-L-HP016

Grupo de arranque de virutas de Mapal*	Material	Rigidez/dureza [N/mm ²] [HRC]	Velocidad de corte v _c (m/min)	Avance f _z (mm/z)
			Refrigeración interna	
P4 P4.1	Aceros inoxidables, ferríticos y martensíticos		50	0,120
P6 P6.1	Fundición de acero inoxidable, ferrítica y martensítica		40	0,120
M	M1.1	Aceros inoxidables, austeníticos	< 700	50
	M1.2	Aceros inoxidables, ferríticos/austeníticos (dúplex)	< 1000	30
	M2.1	Fundición de acero inoxidable, austenítica	< 700	50
	M3.1	Fundición de acero inoxidable, ferrítica/austenítica (dúplex)	< 1000	30

TEC2-DZ-L-HP016

Grupo de arranque de virutas de Mapal*	Material	Rigidez/dureza [N/mm ²] [HRC]	Velocidad de corte v _c (m/min)	Avance f _z (mm/z)
			Refrigeración interna	
P4 P4.1	Aceros inoxidables, ferríticos y martensíticos		50	0,120
P6 P6.1	Fundición de acero inoxidable, ferrítica y martensítica		40	0,120
M	M1.1	Aceros inoxidables, austeníticos	< 700	50
	M1.2	Aceros inoxidables, ferríticos/austeníticos (dúplex)	< 1000	30
	M2.1	Fundición de acero inoxidable, austenítica	< 700	50
	M3.1	Fundición de acero inoxidable, ferrítica/austenítica (dúplex)	< 1000	30

TEC2-04-L-HP016

Grupo de arranque de virutas de Mapal*	Material	Rigidez/dureza [N/mm ²] [HRC]	Velocidad de corte v _c (m/min)	Avance f _z (mm/z)
			Refrigeración interna	
P4 P4.1	Aceros inoxidables, ferríticos y martensíticos		50	0,120
P6 P6.1	Fundición de acero inoxidable, ferrítica y martensítica		40	0,120
M	M1.1	Aceros inoxidables, austeníticos	< 700	50
	M1.2	Aceros inoxidables, ferríticos/austeníticos (dúplex)	< 1000	30
	M2.1	Fundición de acero inoxidable, austenítica	< 700	50
	M3.1	Fundición de acero inoxidable, ferrítica/austenítica (dúplex)	< 1000	30

TEC2-DZ-L-HC418

Grupo de arranque de virutas de Mapal*	Material	Rigidez/dureza [N/mm ²] [HRC]	Velocidad de corte v _c (m/min)	Avance f _z (mm/z)
			Refrigeración interna	
K K1 K1.1	Hierro fundido con grafito laminar (fundición gris), GJL	< 300	100	0,150

* Grupos de mecanizado MAPAL

TEC2-04-L-HC418

Grupo de arranque de virutas de Mapal*	Material	Rigidez/dureza [N/mm ²] [HRC]	Velocidad de corte v _c (m/min)	Avance f _z (mm/z)
			Refrigeración interna	
K K1 K1.1	Hierro fundido con grafito laminar (fundición gris), GJL	< 300	100	0,150

TEC2-DZ-L-HP426

Grupo de arranque de virutas de Mapal*	Material	Rigidez/dureza [N/mm ²] [HRC]	Velocidad de corte v _c (m/min)	Avance f _z (mm/z)
			Refrigeración interna	
K K2	K2.1 Hierro fundido con grafito esférico, GJS	< 500	100	0,150
	K2.2 Hierro fundido con grafito esférico, GJS	≤ 800	90	0,150
	K2.3 Hierro fundido con grafito esférico, GJS	> 800	80	0,150
K K3	K3.1 Hierro fundido con grafito vermicular, GJV; fundición maleable, GJM	< 500	70	0,150
	K3.2 Hierro fundido con grafito vermicular, GJV; fundición maleable, GJM	> 500	70	0,150

TEC2-04-L-HP426

Grupo de arranque de virutas de Mapal*	Material	Rigidez/dureza [N/mm ²] [HRC]	Velocidad de corte v _c (m/min)	Avance f _z (mm/z)
			Refrigeración interna	
K K2	K2.1 Hierro fundido con grafito esférico, GJS	< 500	100	0,150
	K2.2 Hierro fundido con grafito esférico, GJS	≤ 800	90	0,150
	K2.3 Hierro fundido con grafito esférico, GJS	> 800	80	0,150
K K3	K3.1 Hierro fundido con grafito vermicular, GJV; fundición maleable, GJM	< 500	70	0,150
	K3.2 Hierro fundido con grafito vermicular, GJV; fundición maleable, GJM	> 500	70	0,150

TEC2-AS-L-HP612

Grupo de arranque de virutas de Mapal*	Material	Rigidez/dureza [N/mm ²] [HRC]	Velocidad de corte v _c (m/min)	Avance f _z (mm/z)
			Refrigeración interna	
N N1	N1.1 Aluminio, aleado y no aleado < 3 % Si		160	0,150
	N1.2 Aluminio, aleado ≤ 7 % Si		160	0,150

TEC2-EK-L-HP612

Grupo de arranque de virutas de Mapal*	Material	Rigidez/dureza [N/mm ²] [HRC]	Velocidad de corte v _c (m/min)	Avance f _z (mm/z)
			Refrigeración interna	
N N1	N1.1 Aluminio, aleado y no aleado < 3 % Si		160	0,150
	N1.2 Aluminio, aleado ≤ 7 % Si		160	0,150

Los valores de corte indicados son de referencia.

Los datos óptimos para cada situación de mecanizado deben determinarse mediante ensayos o durante el propio proceso de mecanizado.

Recomendación de valores de corte para herramientas de mecanizado exterior con insertos de corte TEC

Avance y velocidad de corte

TEC2-DZ-L-HP612

Grupo de arranque de virutas de Mapal*	Material	Rigidez/dureza [N/mm ²] [HRC]	Velocidad de corte v _c (m/min)	Avance f _z (mm/z)
			Refrigeración interna	
N N1	N1.1 Aluminio, aleado y no aleado < 3 % Si		160	0,150
	N1.2 Aluminio, aleado ≤ 7 % Si		160	0,150

TEC2-04-L-HP612

Grupo de arranque de virutas de Mapal*	Material	Rigidez/dureza [N/mm ²] [HRC]	Velocidad de corte v _c (m/min)	Avance f _z (mm/z)
			Refrigeración interna	
N N1	N1.1 Aluminio, aleado y no aleado < 3 % Si		160	0,150
	N1.2 Aluminio, aleado ≤ 7 % Si		160	0,150

TEC2-AS-L-HU615

Grupo de arranque de virutas de Mapal*	Material	Rigidez/dureza [N/mm ²] [HRC]	Velocidad de corte v _c (m/min)	Avance f _z (mm/z)
			Refrigeración interna	
N N2	N2.1 Cobre, no aleado y de baja aleación	< 300	100	0,150
	N2.2 Cobre, aleado	> 300	100	0,150
	N2.3 Latón, bronce, fundición roja	< 1200	100	0,150
S S1 S S2	S1.1 Titanio, aleaciones de titanio	< 400	30	0,120
	S2.1 Titanio, aleaciones de titanio	< 1200	20	0,120
	S2.2 Titanio, aleaciones de titanio	> 1200	20	0,100

TEC2-EK-L-HU615

Grupo de arranque de virutas de Mapal*	Material	Rigidez/dureza [N/mm ²] [HRC]	Velocidad de corte v _c (m/min)	Avance f _z (mm/z)
			Refrigeración interna	
N N2	N2.1 Cobre, no aleado y de baja aleación	< 300	100	0,150
	N2.2 Cobre, aleado	> 300	100	0,150
	N2.3 Latón, bronce, fundición roja	< 1200	100	0,150
S S1 S S2	S1.1 Titanio, aleaciones de titanio	< 400	30	0,120
	S2.1 Titanio, aleaciones de titanio	< 1200	20	0,120
	S2.2 Titanio, aleaciones de titanio	> 1200	20	0,100

* Grupos de mecanizado MAPAL

** Si los componentes de aleación de Cr, Mo, Ni, V, W suman > 8 %, elegir el siguiente grupo de mecanizado MAPAL superior.

TEC2-DZ-L-HU615

Grupo de arranque de virutas de Mapal*		Material	Rigidez/dureza [N/mm ²] [HRC]	Velocidad de corte v _c (m/min)	Avance f _z (mm/z)	
				Refrigeración interna		
N	N2	N2.1	Cobre, no aleado y de baja aleación	< 300	100	0,150
		N2.2	Cobre, aleado	> 300	100	0,150
		N2.3	Latón, bronce, fundición roja	< 1200	100	0,150
S	S1	S1.1	Titanio, aleaciones de titanio	< 400	30	0,120
		S2.1	Titanio, aleaciones de titanio	< 1200	20	0,120
		S2.2	Titanio, aleaciones de titanio	> 1200	20	0,100

TEC2-04-L-HU615

Grupo de arranque de virutas de Mapal*		Material	Rigidez/dureza [N/mm ²] [HRC]	Velocidad de corte v _c (m/min)	Avance f _z (mm/z)	
				Refrigeración interna		
N	N2	N2.1	Cobre, no aleado y de baja aleación	< 300	100	0,150
		N2.2	Cobre, aleado	> 300	100	0,150
		N2.3	Latón, bronce, fundición roja	< 1200	100	0,150
S	S1	S1.1	Titanio, aleaciones de titanio	< 400	30	0,120
		S2.1	Titanio, aleaciones de titanio	< 1200	20	0,120
		S2.2	Titanio, aleaciones de titanio	> 1200	20	0,100

TEC2-AS-L-CP122

Grupo de arranque de virutas de Mapal*		Material	Rigidez/dureza [N/mm ²] [HRC]	Velocidad de corte v _c (m/min)	Avance f _z (mm/z)	
				Refrigeración interna		
P	P1	P1.1	Aceros de construcción, para tornos automáticos, de cementación y revenidos, no aleados	< 700	180	0,150
		P1.2	Aceros de construcción, para tornos automáticos, de cementación y revenidos, no aleados	< 1200	160	0,120
	P2	P2.1	Aceros nitrurados, de cementación y aceros revenidos, aleados	< 900	160	0,150
		P2.2	Aceros nitrurados, de cementación y aceros revenidos, aleados	< 1400	140	0,120
	P3	P3.1	Aceros para herramientas, rodamientos, resortes y rápidos**	< 800	160	0,150
		P3.2	Aceros para herramientas, rodamientos, resortes y rápidos**	< 1000	160	0,150
		P3.3	Aceros para herramientas, rodamientos, resortes y rápidos**	< 1500	140	0,120
	P5	P5.1	Fundición de acero		140	0,120

Los valores de corte indicados son de referencia.

Los datos óptimos para cada situación de mecanizado deben determinarse mediante ensayos o durante el propio proceso de mecanizado.

Recomendación de valores de corte para herramientas de mecanizado exterior con insertos de corte TEC

Avance y velocidad de corte

TEC2-EK-L-CP122

Grupo de arranque de virutas de Mapal*	Material	Rigidez/dureza [N/mm ²] [HRC]	Velocidad de corte v _c (m/min)	Avance f _z (mm/z)	
			Refrigeración interna		
P	P1.1	Aceros de construcción, para tornos automáticos, de cementación y revenidos, no aleados	< 700	180	0,150
	P1.2	Aceros de construcción, para tornos automáticos, de cementación y revenidos, no aleados	< 1200	160	0,120
	P2.1	Aceros nitrurados, de cementación y aceros revenidos, aleados	< 900	160	0,150
	P2.2	Aceros nitrurados, de cementación y aceros revenidos, aleados	< 1400	140	0,120
	P3.1	Aceros para herramientas, rodamientos, resortes y rápidos**	< 800	160	0,150
	P3.2	Aceros para herramientas, rodamientos, resortes y rápidos**	< 1000	160	0,150
	P3.3	Aceros para herramientas, rodamientos, resortes y rápidos**	< 1500	140	0,120
	P5.1	Fundición de acero		140	0,120

TEC2-DZ-L-CP122

Grupo de arranque de virutas de Mapal*	Material	Rigidez/dureza [N/mm ²] [HRC]	Velocidad de corte v _c (m/min)	Avance f _z (mm/z)	
			Refrigeración interna		
P	P1.1	Aceros de construcción, para tornos automáticos, de cementación y revenidos, no aleados	< 700	180	0,150
	P1.2	Aceros de construcción, para tornos automáticos, de cementación y revenidos, no aleados	< 1200	160	0,120
	P2.1	Aceros nitrurados, de cementación y aceros revenidos, aleados	< 900	160	0,150
	P2.2	Aceros nitrurados, de cementación y aceros revenidos, aleados	< 1400	140	0,120
	P3.1	Aceros para herramientas, rodamientos, resortes y rápidos**	< 800	160	0,150
	P3.2	Aceros para herramientas, rodamientos, resortes y rápidos**	< 1000	160	0,150
	P3.3	Aceros para herramientas, rodamientos, resortes y rápidos**	< 1500	140	0,120
	P5.1	Fundición de acero		140	0,120

TEC2-04-L-CP122

Grupo de arranque de virutas de Mapal*	Material	Rigidez/dureza [N/mm ²] [HRC]	Velocidad de corte v _c (m/min)	Avance f _z (mm/z)	
			Refrigeración interna		
P	P1.1	Aceros de construcción, para tornos automáticos, de cementación y revenidos, no aleados	< 700	180	0,150
	P1.2	Aceros de construcción, para tornos automáticos, de cementación y revenidos, no aleados	< 1200	160	0,120
	P2.1	Aceros nitrurados, de cementación y aceros revenidos, aleados	< 900	160	0,150
	P2.2	Aceros nitrurados, de cementación y aceros revenidos, aleados	< 1400	140	0,120
	P3.1	Aceros para herramientas, rodamientos, resortes y rápidos**	< 800	160	0,150
	P3.2	Aceros para herramientas, rodamientos, resortes y rápidos**	< 1000	160	0,150
	P3.3	Aceros para herramientas, rodamientos, resortes y rápidos**	< 1500	140	0,120
	P5.1	Fundición de acero		140	0,120

* Grupos de mecanizado MAPAL

** Si los componentes de aleación de Cr, Mo, Ni, V, W suman > 8 %, elegir el siguiente grupo de mecanizado MAPAL superior.

TEC2-AS-L-PU620

Grupo de arranque de virutas de Mapal*	Material	Rigidez/dureza [N/mm ²] [HRC]	Velocidad de corte v _c (m/min)	Avance f _z (mm/z)
			Refrigeración interna	
N	N1	N1.1 Aluminio, aleado y no aleado < 3 % Si	230	0,150
		N1.2 Aluminio, aleado ≤ 7 % Si	230	0,150
		N1.3 Aluminio, aleado > 7-12 % Si	230	0,150
		N1.4 Aluminio, aleado > 12 % Si	230	0,150
N	N2	N2.1 Cobre, no aleado y de baja aleación	< 300	180
		N2.2 Cobre, aleado	> 300	180
		N2.3 Latón, bronce, fundición roja	< 1200	180

TEC2-EK-L-PU620

Grupo de arranque de virutas de Mapal*	Material	Rigidez/dureza [N/mm ²] [HRC]	Velocidad de corte v _c (m/min)	Avance f _z (mm/z)
			Refrigeración interna	
N	N1	N1.1 Aluminio, aleado y no aleado < 3 % Si	230	0,150
		N1.2 Aluminio, aleado ≤ 7 % Si	230	0,150
		N1.3 Aluminio, aleado > 7-12 % Si	230	0,150
		N1.4 Aluminio, aleado > 12 % Si	230	0,150
N	N2	N2.1 Cobre, no aleado y de baja aleación	< 300	180
		N2.2 Cobre, aleado	> 300	180
		N2.3 Latón, bronce, fundición roja	< 1200	180

TEC2-DZ-L-PU620

Grupo de arranque de virutas de Mapal*	Material	Rigidez/dureza [N/mm ²] [HRC]	Velocidad de corte v _c (m/min)	Avance f _z (mm/z)
			Refrigeración interna	
N	N1	N1.1 Aluminio, aleado y no aleado < 3 % Si	230	0,150
		N1.2 Aluminio, aleado ≤ 7 % Si	230	0,150
		N1.3 Aluminio, aleado > 7-12 % Si	230	0,150
		N1.4 Aluminio, aleado > 12 % Si	230	0,150
N	N2	N2.1 Cobre, no aleado y de baja aleación	< 300	180
		N2.2 Cobre, aleado	> 300	180
		N2.3 Latón, bronce, fundición roja	< 1200	180

TEC2-04-L-PU620

Grupo de arranque de virutas de Mapal*	Material	Rigidez/dureza [N/mm ²] [HRC]	Velocidad de corte v _c (m/min)	Avance f _z (mm/z)
			Refrigeración interna	
N	N1	N1.1 Aluminio, aleado y no aleado < 3 % Si	230	0,150
		N1.2 Aluminio, aleado ≤ 7 % Si	230	0,150
		N1.3 Aluminio, aleado > 7-12 % Si	230	0,150
		N1.4 Aluminio, aleado > 12 % Si	230	0,150
N	N2	N2.1 Cobre, no aleado y de baja aleación	< 300	180
		N2.2 Cobre, aleado	> 300	180
		N2.3 Latón, bronce, fundición roja	< 1200	180

Los valores de corte indicados son de referencia.

Los datos óptimos para cada situación de mecanizado deben determinarse mediante ensayos o durante el propio proceso de mecanizado.

Recomendación de valores de corte para herramientas de mecanizado exterior con insertos de corte

Avance y velocidad de corte

AS-L-HP115

Grupo de arranque de virutas de Mapal*	Material	Rigidez/dureza [N/mm ²] [HRC]	Velocidad de corte v _c (m/min)	Avance f _z (mm/z)	
			Refrigeración interna		
P P1	P1.1	Aceros de construcción, para tornos automáticos, de cementación y revenidos, no aleados	< 700	80	0,150
	P1.2	Aceros de construcción, para tornos automáticos, de cementación y revenidos, no aleados	< 1200	70	0,150

EK-L-HP115

Grupo de arranque de virutas de Mapal*	Material	Rigidez/dureza [N/mm ²] [HRC]	Velocidad de corte v _c (m/min)	Avance f _z (mm/z)	
			Refrigeración interna		
P P1	P1.1	Aceros de construcción, para tornos automáticos, de cementación y revenidos, no aleados	< 700	80	0,150
	P1.2	Aceros de construcción, para tornos automáticos, de cementación y revenidos, no aleados	< 1200	70	0,150

DZ-L-HP115

Grupo de arranque de virutas de Mapal*	Material	Rigidez/dureza [N/mm ²] [HRC]	Velocidad de corte v _c (m/min)	Avance f _z (mm/z)	
			Refrigeración interna		
P P1	P1.1	Aceros de construcción, para tornos automáticos, de cementación y revenidos, no aleados	< 700	80	0,150
	P1.2	Aceros de construcción, para tornos automáticos, de cementación y revenidos, no aleados	< 1200	70	0,150

AS-L-HP425

Grupo de arranque de virutas de Mapal*	Material	Rigidez/dureza [N/mm ²] [HRC]	Velocidad de corte v _c (m/min)	Avance f _z (mm/z)	
			Refrigeración interna		
P	P2.1	Aceros nitrurados, de cementación y aceros revenidos, aleados	< 900	100	0,150
	P2.2	Aceros nitrurados, de cementación y aceros revenidos, aleados	< 1400	80	0,150
	P3.1	Aceros para herramientas, rodamientos, resortes y rápidos**	< 900	100	0,150
	P3.2	Aceros para herramientas, rodamientos, resortes y rápidos**	< 1500	80	0,150
	P5.1	Fundición de acero		80	0,150

* Grupos de mecanizado MAPAL

** Si los componentes de aleación de Cr, Mo, Ni, V, W suman > 8 %, elegir el siguiente grupo de mecanizado MAPAL superior.

EK-L-HP425

Grupo de arranque de virutas de Mapal*	Material	Rigidez/dureza [N/mm ²] [HRC]	Velocidad de corte v _c (m/min)	Avance f _z (mm/z)	
			Refrigeración interna		
P	P2.1	Aceros nitrurados, de cementación y aceros revenidos, aleados	< 900	100	0,150
	P2.2	Aceros nitrurados, de cementación y aceros revenidos, aleados	< 1400	80	0,150
	P3.1	Aceros para herramientas, rodamientos, resortes y rápidos**	< 900	100	0,150
	P3.2	Aceros para herramientas, rodamientos, resortes y rápidos**	< 1500	80	0,150
	P5.1	Fundición de acero		80	0,150

DZ-L-HP425

Grupo de arranque de virutas de Mapal*	Material	Rigidez/dureza [N/mm ²] [HRC]	Velocidad de corte v _c (m/min)	Avance f _z (mm/z)	
			Refrigeración interna		
P	P2.1	Aceros nitrurados, de cementación y aceros revenidos, aleados	< 900	100	0,150
	P2.2	Aceros nitrurados, de cementación y aceros revenidos, aleados	< 1400	80	0,150
	P3.1	Aceros para herramientas, rodamientos, resortes y rápidos**	< 900	100	0,150
	P3.2	Aceros para herramientas, rodamientos, resortes y rápidos**	< 1500	80	0,150
	P5.1	Fundición de acero		80	0,150

AS-L-HP016

Grupo de arranque de virutas de Mapal*	Material	Rigidez/dureza [N/mm ²] [HRC]	Velocidad de corte v _c (m/min)	Avance f _z (mm/z)	
			Refrigeración interna		
P	P4.1	Aceros inoxidables, ferríticos y martensíticos	50	0,120	
	P6.1	Fundición de acero inoxidable, ferrítica y martensítica	40	0,120	
M	M1.1	Aceros inoxidables, austeníticos	< 700	50	0,120
	M1.2	Aceros inoxidables, ferríticos/austeníticos (dúplex)	< 1000	30	0,120
	M2.1	Fundición de acero inoxidable, austenítica	< 700	50	0,120
	M3.1	Fundición de acero inoxidable, ferrítica/austenítica (dúplex)	< 1000	30	0,120

EK-L-HP016

Grupo de arranque de virutas de Mapal*	Material	Rigidez/dureza [N/mm ²] [HRC]	Velocidad de corte v _c (m/min)	Avance f _z (mm/z)	
			Refrigeración interna		
P	P4.1	Aceros inoxidables, ferríticos y martensíticos	50	0,120	
	P6.1	Fundición de acero inoxidable, ferrítica y martensítica	40	0,120	
M	M1.1	Aceros inoxidables, austeníticos	< 700	50	0,120
	M1.2	Aceros inoxidables, ferríticos/austeníticos (dúplex)	< 1000	30	0,120
	M2.1	Fundición de acero inoxidable, austenítica	< 700	50	0,120
	M3.1	Fundición de acero inoxidable, ferrítica/austenítica (dúplex)	< 1000	30	0,120

Los valores de corte indicados son de referencia.

Los datos óptimos para cada situación de mecanizado deben determinarse mediante ensayos o durante el propio proceso de mecanizado.

Recomendación de valores de corte para herramientas de mecanizado exterior con insertos de corte

Avance y velocidad de corte

DZ-L-HP016

Grupo de arranque de virutas de Mapal*	Material	Rigidez/dureza [N/mm ²] [HRC]	Velocidad de corte v _c (m/min)	Avance f _z (mm/z)
			Refrigeración interna	
P4 P4.1	Aceros inoxidables, ferríticos y martensíticos		50	0,120
P6 P6.1	Fundición de acero inoxidable, ferrítica y martensítica		40	0,120
M	M1.1	Aceros inoxidables, austeníticos	< 700	50
	M1.2	Aceros inoxidables, ferríticos/austeníticos (dúplex)	< 1000	30
	M2.1	Fundición de acero inoxidable, austenítica	< 700	50
	M3.1	Fundición de acero inoxidable, ferrítica/austenítica (dúplex)	< 1000	30

DZ-L-HC418

Grupo de arranque de virutas de Mapal*	Material	Rigidez/dureza [N/mm ²] [HRC]	Velocidad de corte v _c (m/min)	Avance f _z (mm/z)
			Refrigeración interna	
K K1 K1.1	Hierro fundido con grafito laminar (fundición gris), GJL	< 300	100	0,150

DZ-L-HP426

Grupo de arranque de virutas de Mapal*	Material	Rigidez/dureza [N/mm ²] [HRC]	Velocidad de corte v _c (m/min)	Avance f _z (mm/z)
			Refrigeración interna	
K2	K2.1	Hierro fundido con grafito esferoidal, GJS	< 500	100
	K2.2	Hierro fundido con grafito esferoidal, GJS	≤ 800	90
	K2.3	Hierro fundido con grafito esferoidal, GJS	> 800	80
K3	K3.1	Hierro fundido con grafito vermicular, GJV; fundición maleable, GJM	< 500	70
	K3.2	Hierro fundido con grafito vermicular, GJV; fundición maleable, GJM	> 500	70

AS-L-HP612

Grupo de arranque de virutas de Mapal*	Material	Rigidez/dureza [N/mm ²] [HRC]	Velocidad de corte v _c (m/min)	Avance f _z (mm/z)
			Refrigeración interna	
N N1	N1.1	Aluminio, aleado y no aleado < 3 % Si	160	0,150
	N1.2	Aluminio, aleado ≤ 7 % Si	160	0,150

EK-L-HP612

Grupo de arranque de virutas de Mapal*	Material	Rigidez/dureza [N/mm ²] [HRC]	Velocidad de corte v _c (m/min)	Avance f _z (mm/z)
			Refrigeración interna	
N N1	N1.1	Aluminio, aleado y no aleado < 3 % Si	160	0,150
	N1.2	Aluminio, aleado ≤ 7 % Si	160	0,150

* Grupos de mecanizado MAPAL

AS-L-HU615

Grupo de arranque de virutas de Mapal*		Material	Rigidez/dureza [N/mm ²] [HRC]	Velocidad de corte v _c (m/min)	Avance f _z (mm/z)	
				Refrigeración interna		
N	N2	N2.1	Cobre, no aleado y de baja aleación	< 300	100	0,150
		N2.2	Cobre, aleado	> 300	100	0,150
		N2.3	Latón, bronce, fundición roja	< 1200	100	0,150
S	S2	S2.1	Titanio, aleaciones de titanio	< 400	30	0,120
		S2.1	Titanio, aleaciones de titanio	< 1200	20	0,120
		S2.2	Titanio, aleaciones de titanio	> 1200	20	0,100

EK-L-HU615

Grupo de arranque de virutas de Mapal*		Material	Rigidez/dureza [N/mm ²] [HRC]	Velocidad de corte v _c (m/min)	Avance f _z (mm/z)	
				Refrigeración interna		
N	N2	N2.1	Cobre, no aleado y de baja aleación	< 300	100	0,150
		N2.2	Cobre, aleado	> 300	100	0,150
		N2.3	Latón, bronce, fundición roja	< 1200	100	0,150
S	S2	S2.1	Titanio, aleaciones de titanio	< 400	30	0,120
		S2.1	Titanio, aleaciones de titanio	< 1200	20	0,120
		S2.2	Titanio, aleaciones de titanio	> 1200	20	0,100

DZ-L-HU615

Grupo de arranque de virutas de Mapal*		Material	Rigidez/dureza [N/mm ²] [HRC]	Velocidad de corte v _c (m/min)	Avance f _z (mm/z)	
				Refrigeración interna		
N	N2	N2.1	Cobre, no aleado y de baja aleación	< 300	100	0,150
		N2.2	Cobre, aleado	> 300	100	0,150
		N2.3	Latón, bronce, fundición roja	< 1200	100	0,150

Los valores de corte indicados son de referencia.

Los datos óptimos para cada situación de mecanizado deben determinarse mediante ensayos o durante el propio proceso de mecanizado.

Recomendación de valores de corte para herramientas de mecanizado exterior con insertos de corte

Avance y velocidad de corte

AS-L-CP122

Grupo de arranque de virutas de Mapal*	Material	Rigidez/dureza [N/mm ²] [HRC]	Velocidad de corte v _c (m/min)	Avance f _z (mm/z)	
			Refrigeración interna		
P	P1.1	Aceros de construcción, para tornos automáticos, de cementación y revenidos, no aleados	< 700	180	0,150
	P1.2	Aceros de construcción, para tornos automáticos, de cementación y revenidos, no aleados	< 1200	160	0,120
	P2.1	Aceros nitrurados, de cementación y aceros revenidos, aleados	< 900	160	0,150
	P2.2	Aceros nitrurados, de cementación y aceros revenidos, aleados	< 1400	140	0,120
	P3.1	Aceros para herramientas, rodamientos, resortes y rápidos**	< 800	160	0,150
	P3.2	Aceros para herramientas, rodamientos, resortes y rápidos**	< 1000	160	0,150
	P3.3	Aceros para herramientas, rodamientos, resortes y rápidos**	< 1500	140	0,120
	P5.1	Fundición de acero		140	0,120

EK-L-CP122

Grupo de arranque de virutas de Mapal*	Material	Rigidez/dureza [N/mm ²] [HRC]	Velocidad de corte v _c (m/min)	Avance f _z (mm/z)	
			Refrigeración interna		
P	P1.1	Aceros de construcción, para tornos automáticos, de cementación y revenidos, no aleados	< 700	180	0,150
	P1.2	Aceros de construcción, para tornos automáticos, de cementación y revenidos, no aleados	< 1200	160	0,120
	P2.1	Aceros nitrurados, de cementación y aceros revenidos, aleados	< 900	160	0,150
	P2.2	Aceros nitrurados, de cementación y aceros revenidos, aleados	< 1400	140	0,120
	P3.1	Aceros para herramientas, rodamientos, resortes y rápidos**	< 800	160	0,150
	P3.2	Aceros para herramientas, rodamientos, resortes y rápidos**	< 1000	160	0,150
	P3.3	Aceros para herramientas, rodamientos, resortes y rápidos**	< 1500	140	0,120
	P5.1	Fundición de acero		140	0,120

DZ-L-CP122

Grupo de arranque de virutas de Mapal*	Material	Rigidez/dureza [N/mm ²] [HRC]	Velocidad de corte v _c (m/min)	Avance f _z (mm/z)	
			Refrigeración interna		
P	P1.1	Aceros de construcción, para tornos automáticos, de cementación y revenidos, no aleados	< 700	180	0,150
	P1.2	Aceros de construcción, para tornos automáticos, de cementación y revenidos, no aleados	< 1200	160	0,120
	P2.1	Aceros nitrurados, de cementación y aceros revenidos, aleados	< 900	160	0,150
	P2.2	Aceros nitrurados, de cementación y aceros revenidos, aleados	< 1400	140	0,120
	P3.1	Aceros para herramientas, rodamientos, resortes y rápidos**	< 800	160	0,150
	P3.2	Aceros para herramientas, rodamientos, resortes y rápidos**	< 1000	160	0,150
	P3.3	Aceros para herramientas, rodamientos, resortes y rápidos**	< 1500	140	0,120
	P5.1	Fundición de acero		140	0,120

* Grupos de mecanizado MAPAL

** Si los componentes de aleación de Cr, Mo, Ni, V, W suman > 8 %, elegir el siguiente grupo de mecanizado MAPAL superior.

AS-L-PU620

Grupo de arranque de virutas de Mapal*	Material	Rigidez/dureza [N/mm ²] [HRC]	Velocidad de corte v _c (m/min)	Avance f _z (mm/z)	
			Refrigeración interna		
N	N1	N1.1 Aluminio, aleado y no aleado < 3 % Si	230	0,150	
		N1.2 Aluminio, aleado ≤ 7 % Si	230	0,150	
		N1.3 Aluminio, aleado > 7-12 % Si	230	0,150	
		N1.4 Aluminio, aleado > 12 % Si	230	0,150	
	N2	N2.1 Cobre, no aleado y de baja aleación	< 300	180	0,150
		N2.2 Cobre, aleado	> 300	180	0,150
		N2.3 Latón, bronce, fundición roja	< 1200	180	0,150

EK-L-PU620

Grupo de arranque de virutas de Mapal*	Material	Rigidez/dureza [N/mm ²] [HRC]	Velocidad de corte v _c (m/min)	Avance f _z (mm/z)	
			Refrigeración interna		
N	N1	N1.1 Aluminio, aleado y no aleado < 3 % Si	230	0,150	
		N1.2 Aluminio, aleado ≤ 7 % Si	230	0,150	
		N1.3 Aluminio, aleado > 7-12 % Si	230	0,150	
		N1.4 Aluminio, aleado > 12 % Si	230	0,150	
	N2	N2.1 Cobre, no aleado y de baja aleación	< 300	180	0,150
		N2.2 Cobre, aleado	> 300	180	0,150
		N2.3 Latón, bronce, fundición roja	< 1200	180	0,150

Los valores de corte indicados son de referencia.

Los datos óptimos para cada situación de mecanizado deben determinarse mediante ensayos o durante el propio proceso de mecanizado.

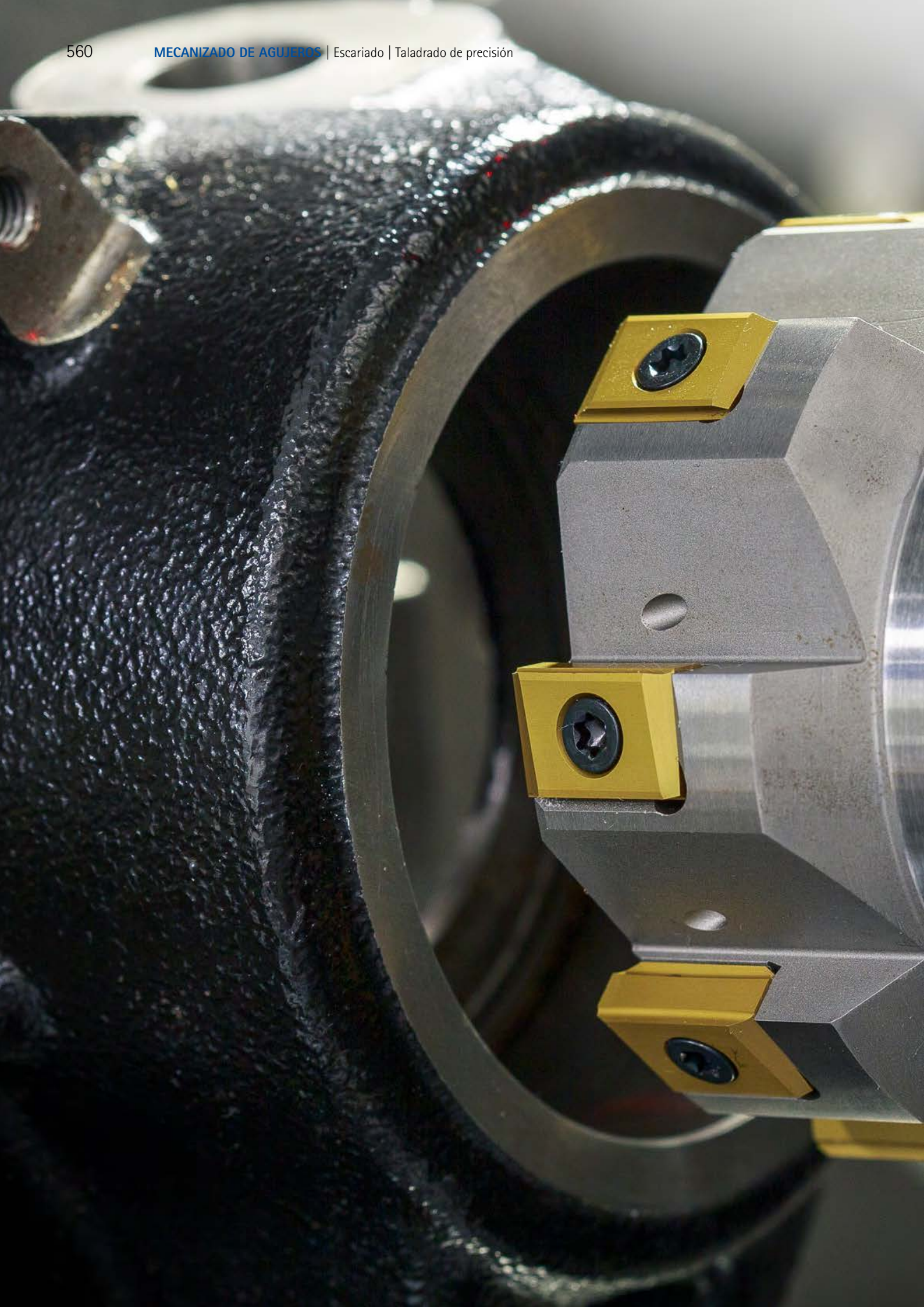

SOLUCIONES PARA DIÁMETROS GRANDES | SOLUCIONES ESPECIALES

Soluciones para diámetros grandes

Vista general del surtido	562
HPR400 plus	564
HPR400	568

Soluciones especiales

Herramientas con guías de apoyo	572
Herramientas con sistema EasyAdjust	574
Escariadores de múltiples filos	576



VISTA GENERAL DEL PROGRAMA

Escariadores de alto rendimiento de múltiples filos para rangos de diámetros grandes

Para mecanizar con precisión agujeros con diámetros grandes en una tolerancia definida, los usuarios a menudo se preguntan: ¿escariado o mandrinado de acabado? Por una parte, las herramientas escariadoras de varios filos permiten trabajar con mayor rapidez y son menos sensibles con un mecanizado interrumpido. Por otra parte, la preparación de los escariadores con insertos fijos es un proceso laborioso.

Con el fin de optimizar este proceso de reacondicionamiento, MAPAL ofrece dos sistemas HPR:

PR400 plus

El aumento de la rentabilidad mediante un reacondicionamiento eficiente constituye uno de los principios del desarrollo de los escariadores HPR400 plus. Las herramientas de múltiples filos destacan por una alta rentabilidad, gracias a unas condiciones de corte rápidas y a un sencillo cambio de inserto in situ por parte del cliente. Esto es posible debido a los asientos de placas altamente precisos. De esta manera se suprimen por completo los costes logísticos de transporte hasta las instalaciones del fabricante. La cantidad de herramientas en circulación y los costes de reacondicionamiento se mantienen reducidos. Los insertos de corte reversibles con cuatro filos de corte garantizan el aprovechamiento óptimo del material de corte.

HPR400

Sencillo cambio de insertos in situ

Con el fin de reducir la cantidad de herramientas en circulación y el stock de las mismas, MAPAL ofrece el sistema HPR400, con el que el cliente puede realizar por su cuenta el cambio de insertos in situ. No es necesario reacondicionar los cuerpos de las herramientas, tan solo se requiere disponer de los insertos necesarios en stock.

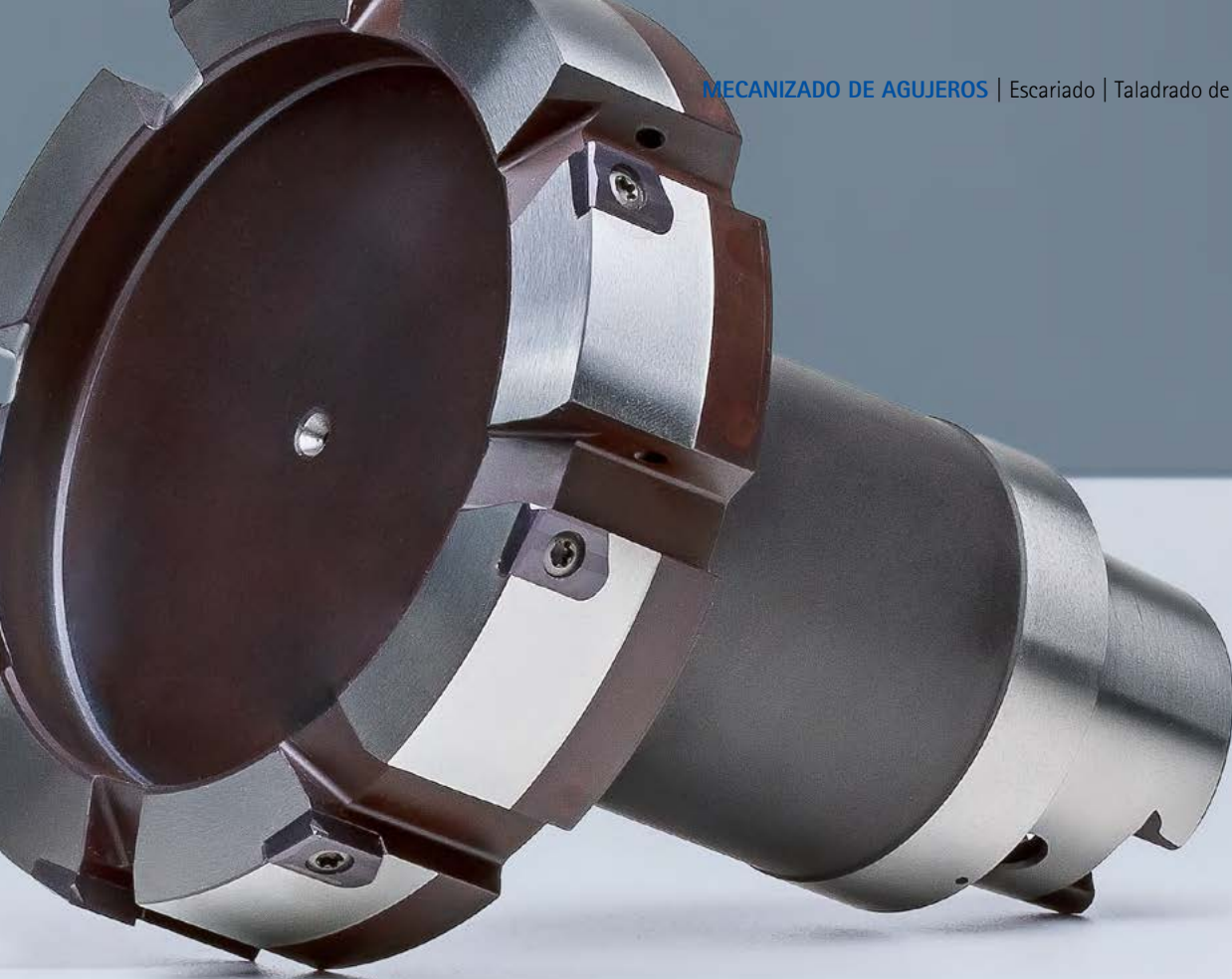

HPR



HPR400 plus

- Cuatro filos de corte para una elevada rentabilidad.
- Sin costes logísticos de transporte hasta las instalaciones del fabricante para el reacondicionamiento
 - Tolerancia IT7 realizable a partir de un diámetro de 65,000 mm

Rango de Ø: 63,000 - 319,999 mm



HPR400

- Sencillo cambio de insertos in situ.
- Se excluye el montaje incorrecto del inserto, los insertos pueden montarse en cualquier posición.

Rango de Ø: 63,000 - 319,999 mm



HPR400 plus

Sin ajuste y con cuatro filos de corte para reducir considerablemente el coste por pieza

El incremento de la rentabilidad mediante un reacondicionamiento eficiente constituye uno de los principios del desarrollo de los escariadores HPR400. Las herramientas de múltiples filos destacan por una alta rentabilidad, gracias a unas condiciones de corte rápidas y a un sencillo cambio de inserto in situ por parte del cliente. Esto es posible debido a los asientos de placas altamente precisos. De esta manera se suprimen por completo los costes logísticos de transporte hasta las instalaciones del fabricante. La cantidad de herramientas en circulación y los costes de reacondicionamiento se mantienen reducidos.

Con el fin de incrementar aún más la rentabilidad del mecanizado de grandes diámetros, las placas de corte del nuevo HPR400 plus ya no constan de un solo filo, sino que presentan cuatro filos de corte. De este modo se aprovecha óptimamente el material de corte. Los insertos de corte de cuatro filos se fabrican con una precisión tan elevada que los empleados del cliente pueden invertir o cambiar las placas de corte sin problemas.

El stock de insertos puede reducirse aún más, disminuyendo también los costes de reacondicionamiento y los costes por pieza.

RESUMEN

- Cambio de inserto in situ por parte del cliente
- Cuatro filos de corte en lugar de uno
- Rango de diámetro de 63,000 a 319,999 mm
- Puede utilizarse universalmente en todos los materiales
- Utilización óptima del material de corte
- Sin costes logísticos para el transporte al fabricante para el reacondicionamiento
- Cantidad de herramientas en circulación y costes de reacondicionamiento reducidos
- Sencilla inversión y cambio de las placas de corte

Características detalladas de la herramienta



1 Placa de corte

Con cuatro filos para una alta rentabilidad

2 Bolsa rascadora

Para eliminar las microimpurezas

3 Tornillo TORX® PLUS

4 Asiento de placas

Altamente preciso para cumplir óptimamente con las tolerancias

5 Ranura de impurezas

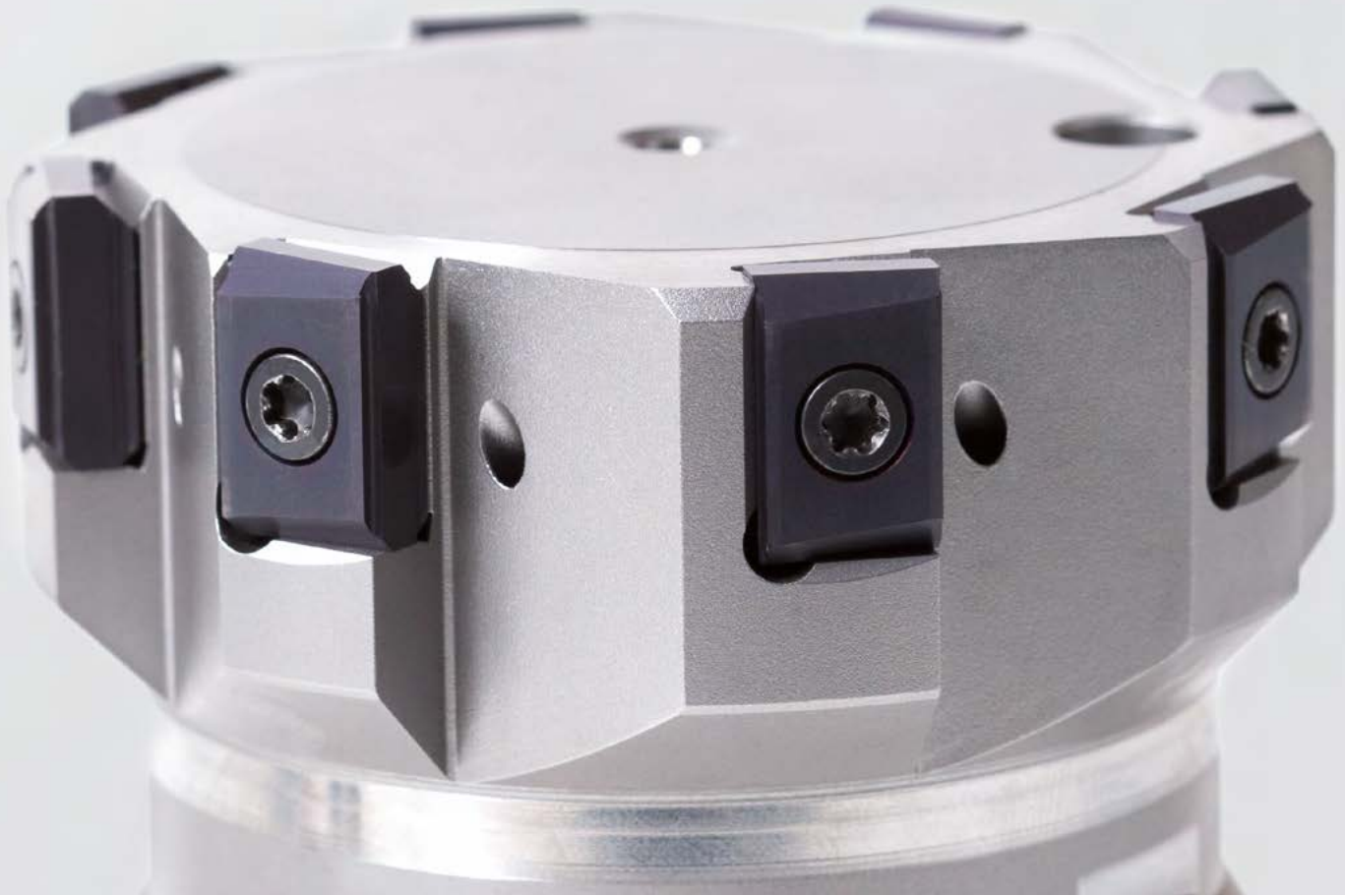

HPR400 plus



Cambio de inserto in situ por parte del cliente

- Manejo sencillo
- Preciso cambio de inserto gracias al asiento de insertos altamente preciso
- No se requiere ajuste



Cuatro filos de corte para una elevada rentabilidad

- Diferentes materiales de corte y entradas disponibles
- Cortes especiales a petición

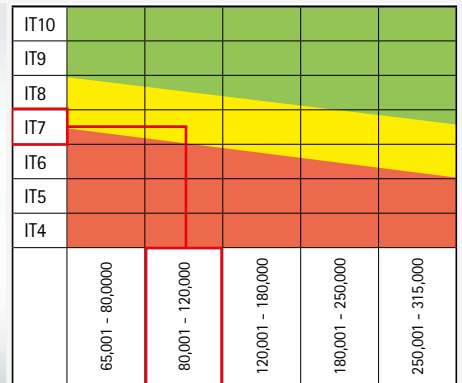

Tolerancia IT7 a partir de un diámetro de 65 mm

- La clase de tolerancia IT7 puede realizarse sin problemas para diámetros mayores, al igual que tolerancias más pequeñas para diámetros mayores

Escariador de alto rendimiento, HPR400 plus

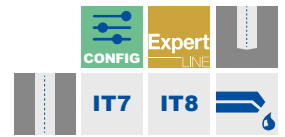
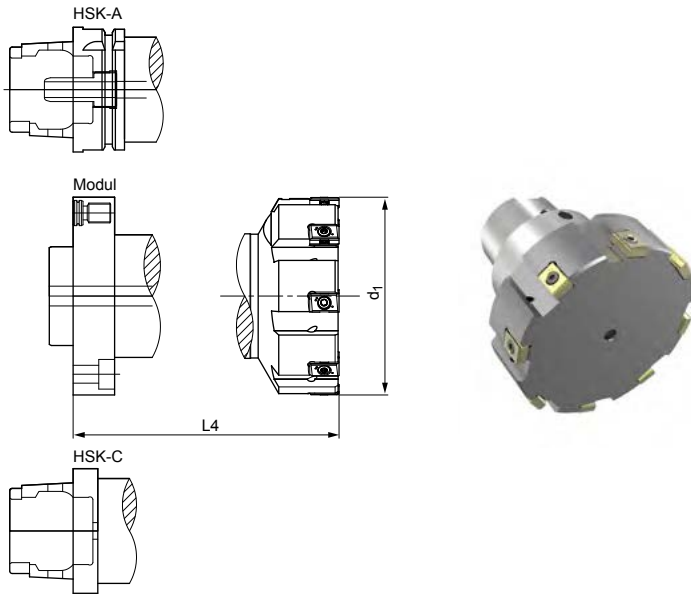

Dimensiones del cuerpo HPR400 plus

d ₁	z	Tamaño del amarre				
		HSK-C	HSK-A	Longitud de voladizo L4 seleccionable libremente	Módulo	Longitud de voladizo L4 seleccionable libremente
63,000 - 79,999	8	HSK-C063	HSK-A063	65-290	60	65-320
80,000 - 99,999	8	HSK-C063	HSK-A063	65-290	80	65-320
100,000 - 124,999	8	HSK-C080	HSK-A080	75-330	100	75-320
125,000 - 159,999	8	HSK-C080	HSK-A080	75-330	100	75-320
160,000 - 199,999	8	HSK-C080	HSK-A080	75-330	140	90-320
200,000 - 249,999	10	HSK-C100	HSK-A100	90-300	140	90-320
250,000 - 319,999	12	HSK-C100	HSK-A100	90-300	140	90-320

Los datos son solo valores de referencia, desviaciones a petición

Características configurables



- Diámetro seleccionable libremente en incrementos de 0,001 mm
- Se puede pedir a partir de la tolerancia IT7 - IT8 (mín. 40 µm)
- Todos los amarres comunes son posibles como interfaz
- Ejecutable como herramienta escalonada
- Combinable con otros sistemas de herramientas MAPAL y sistemas de amarre MAPAL
- Compatible con MMS

Especificación
A petición

Accesorios y refacciones	Número de material
Juego de llave dinamométrica 1 - 5 Nm	30415174
Tornillo de sustitución M4x12	10018468

Medidas en mm.

Otras entrada y materiales de corte a petición.

Insertos de corte para HPR400 plus



Serie preferente de insertos

Rango de diámetros	Número de material
63,000 - 79,999	30968871
80,000 - 99,999	30933385
100,000 - 124,999	30968884
125,000 - 159,999	30968891
160,000 - 199,999	30968898
200,000 - 249,999	30968905
250,000 - 319,999	30968912

Ejecución:

Rango de diámetros: 63,000 - 319,999
 Cuatro filos de corte
 Entrada: 45° x 0,55 mm
 Material de corte: HC419



Serie preferente de insertos

Rango de diámetros	Número de material
63,000 - 79,999	31315612
80,000 - 99,999	31315613
100,000 - 124,999	31149561
125,000 - 159,999	31315614
160,000 - 199,999	31315615
200,000 - 249,999	31315617
250,000 - 319,999	31315618

Ejecución:

Rango de diámetros: 63,000 - 319,999
 Cuatro filos de corte
 Entrada: 30° x 0,60 mm + ángulo de pelado
 Material de corte: CP004
 Grupo de materiales K
 Apto para superficie Ra < 2 µm

Medidas en mm.

Otras entrada y materiales de corte a petición.



HPR400

Escariado de diámetros grandes con sencillo cambio de insertos in situ

Los asientos de insertos especiales y altamente precisos de la serie HPR400 hacen posible que en este sistema los propios usuarios cambien los filos in situ utilizando una llave dinamométrica. Sin fallos de montaje, ya que solo es posible una posición de montaje y los insertos pueden montarse como se desee. De este modo, no solo se ahorra el esfuerzo de ajuste, sino también el suministro para el reacondicionamiento. Los usuarios solo deben tener en existencias los insertos de MAPAL. La cantidad de herramientas necesarias es reducida, ya que no tiene que prepararse ningún cuerpo. Con un esfuerzo mínimo y una cantidad reducida de herramientas en circulación, el usuario logra taladros de alta precisión con el HPR400.

Los insertos se adaptan óptimamente al material y al proceso de mecanizado. El sistema HPR400 está disponible en un rango de diáme

tros de 63 a 319,999 mm, con el alojamiento del módulo HSK o el alojamiento del módulo de MAPAL. MAPAL ofrece diferentes placas de corte de metal duro, con o sin recubrimiento CVD, de cermet y equipadas con PCD o PcBN.

RESUMEN

- Cambio de insertos in situ por parte del usuario
- Asignación del inserto con independencia del asiento de insertos
- Reducción del coste por pieza (CPP)
- Costes de recubrimiento reducidos
- Reducción de la cantidad de herramientas en circulación
- Posibilidad de utilizar todos los materiales de corte
- Tolerancia H7
- \varnothing 63,000 – 319,999 mm

Características detalladas de la herramienta

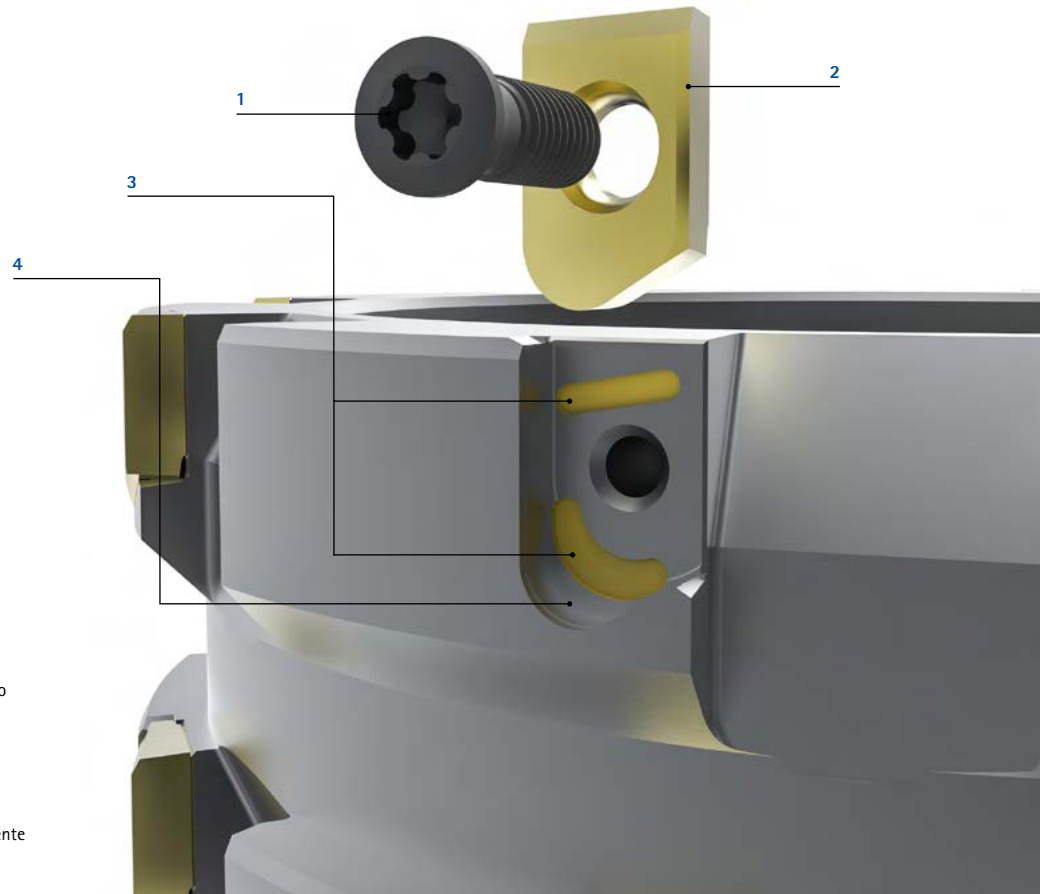

1 Tornillo de sujeción TORX®

2 Inserto

Forma prismática para un contacto óptimo

3 Bolsa rascadora

Para eliminar las microimpurezas

4 Asiento de placas

Altamente preciso para cumplir óptimamente con las tolerancias

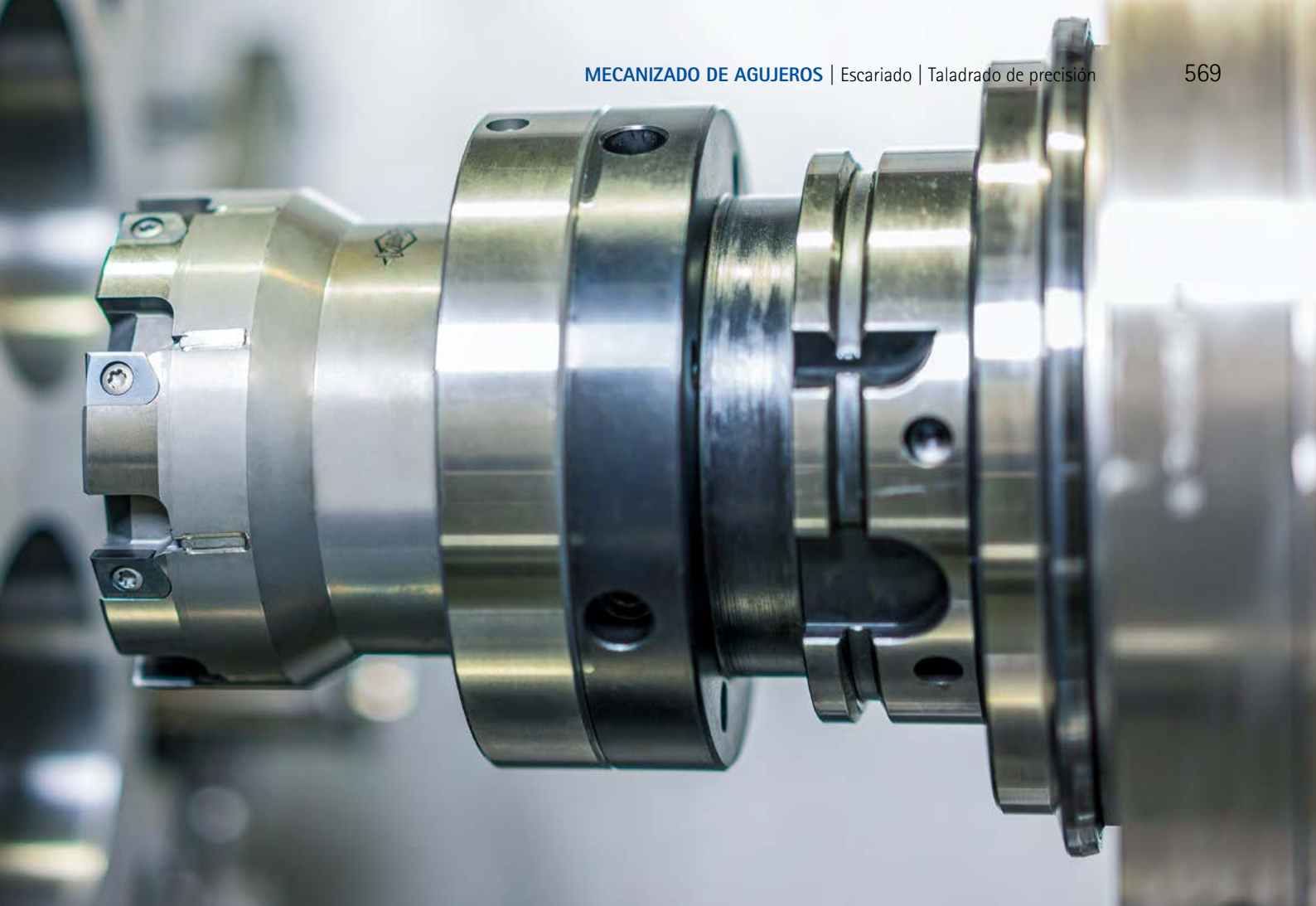

Insertos con recubrimiento CVD



Adaptación óptima al escariado de materiales de fundición

Los materiales de corte con recubrimiento CVD que están disponibles para el sistema HPR400, reconocibles por la abreviatura de material de corte HC, se han desarrollado especialmente para el escariado de los materiales de fundición tenaces GJL, GJS y GJV, en condiciones de mecanizado complicadas como el corte interrumpido. El recubrimiento CVD se caracteriza por una gran tenacidad con una buena resistencia al desgaste. Con los insertos con recubrimiento CVD puede alcanzarse una vida útil hasta tres veces mayor que con los insertos con recubrimiento PVD existentes con una elevada seguridad en el proceso. Además, el sistema de sujeción permite utilizar casi todos los demás materiales de corte en el sistema HPR400.

Sistema rentable



Sencillo cambio de insertos in situ

Con el HPR400, MAPAL ofrece un sistema en el que el cambio de insertos es realizado in situ por el cliente. Los insertos sustituibles se colocan axialmente en el asiento de placa de corte y, con ayuda de un tornillo TORX®, se fijan de manera segura y altamente precisa en el asiento de insertos altamente preciso. Además, la asignación del inserto no depende del asiento de insertos. Los costes de recubrimiento se reducen y, al mismo tiempo, disminuye la cantidad de herramientas en circulación.

Escariador de alto rendimiento HPR400

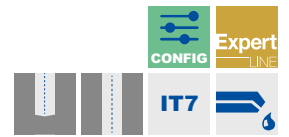
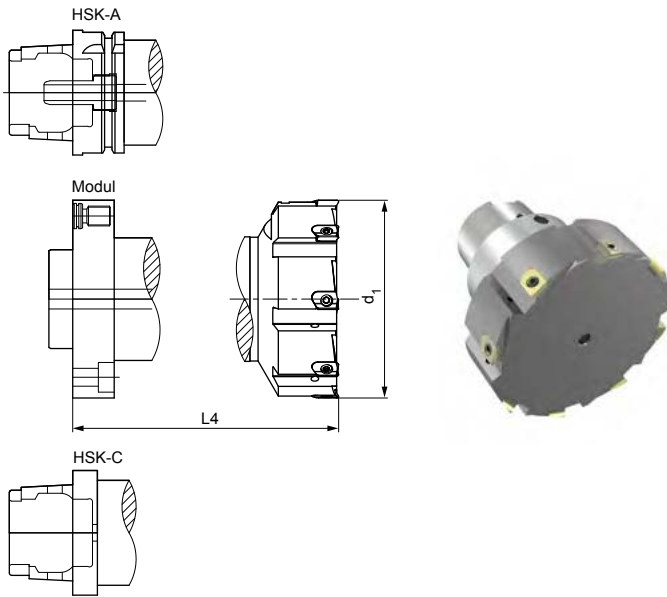

Dimensiones del cuerpo HPR400

d ₁	z	Tamaño del amarre				
		HSK-C	HSK-A	Longitud de voladizo L4 seleccionable libremente	Módulo	Longitud de voladizo L4 seleccionable libremente
63,000 - 79,999	8	HSK-C063	HSK-A063	65-290	60	65-320
80,000 - 99,999	8	HSK-C063	HSK-A063	65-290	80	65-320
100,000 - 124,999	8	HSK-C080	HSK-A080	75-330	100	75-320
125,000 - 159,999	8	HSK-C080	HSK-A080	75-330	100	75-320
160,000 - 199,999	8	HSK-C080	HSK-A080	75-330	140	90-320
200,000 - 249,999	10	HSK-C100	HSK-A100	90-300	140	90-320
250,000 - 319,999	12	HSK-C100	HSK-A100	90-300	140	90-320

Los datos son solo valores de referencia, desviaciones a petición

Características configurables



- Diámetro seleccionable libremente en incrementos de 0,001 mm
- Se puede pedir a partir de la tolerancia IT7
- Posibilidad de corte frontal
- Todos los amarres comunes son posibles como interfaz
- Ejecutable como herramienta escalonada
- Combinable con otros sistemas de herramientas MAPAL y sistemas de amarre MAPAL
- Compatible con MMS

Especificación
A petición



Accesorios y refacciones	Número de material
Juego de llave dinamométrica 1 – 5 Nm	30415174
Tornillo de sustitución M3,5x9	10105078

Medidas en mm.

Otras entrada y materiales de corte a petición.

Placas de corte para HPR400



Serie preferente de insertos

Rango de diámetros	Número de material
63,000 - 79,999	30916603
80,000 - 99,999	30794390
100,000 - 124,999	30809550
125,000 - 159,999	30788089
160,000 - 199,999	30809531
200,000 - 249,999	30938712
250,000 - 319,999	30931640

Ejecución:

Rango de diámetros: 63,000 - 319,999
 Un filo de corte
 Entrada: 45° x 0,55 mm
 Material de corte: HC419



Serie preferente de insertos

Rango de diámetros	Número de material
63,00 - 79,99	31026872
80,00 - 99,99	31129899
100,00 - 124,99	31049249
125,00 - 159,99	30690096
160,00 - 199,99	31149706
200,00 - 249,99	31149707
250,00 - 319,99	31129911

Ejecución:

Rango de diámetros: 63,000 - 319,999
 Un filo de corte
 Entrada: 30° x 0,60 mm + ángulo de pelado
 Material de corte: CP004
 Grupo de materiales K
 Apto para superficie Ra < 2 µm

Medidas en mm.

Otras entrada y materiales de corte a petición.

SOLUCIONES ESPECIALES

Herramientas con guías de apoyo

Soluciones de herramientas para aplicaciones específicas

- 1 Herramienta de mandrinado con guías de apoyo y soporte de sujeción corto ISO de construcción ligera de aluminio para el mecanizado de una caja de cambios
- 2 Herramienta de taladrado de precisión con sistema de insertos de corte para el mecanizado interior y exterior combinado de un soporte planetario
- 3 Escariador exterior con sistema EasyAdjust y insertos TEC para el mecanizado de un múltiple de escape con portaherramientas flotante MAPAL
- 4 Herramienta de taladrado de precisión con escalón de desbaste ISO e interfaz para cabezal de escariado HPR para el mecanizado de un bloque de cilindros
- 5 Herramienta de taladrado de precisión con sistema EasyAdjust y con insertos HX para el mecanizado de un agujero de un cojinete de cigüeñal
- 6 Herramienta de taladrado de precisión de construcción ligera como estructura soldada para el mecanizado de una caja de cambios
- 7 Herramienta de taladrado de precisión escalonada y de múltiples filos de construcción ligera de titanio para el mecanizado de un cárter de dirección
- 8 Herramienta de taladrado de precisión con sistema de insertos de corte diseñado para la lubricación minimizada (MQL), para el mecanizado de la carcasa de un pistón hidráulico
- 9 Herramienta escalonada de taladrado de precisión con sistema de insertos de corte con corte de contornos y planeado de un cárter de bomba
- 10 Herramienta de taladrado de precisión con sistema de insertos de corte para el mecanizado combinado de un soporte planetario
- 11 Herramienta de taladrado de precisión tangencial para el mecanizado de semiacabado con cabezal cortador modular, para el mecanizado de un agujero de cojinete de cigüeñal
- 12 Escariador exterior con sistema de insertos de corte para el mecanizado de un perno de pistón hidráulico, fabricado de forma aditiva como construcción ligera



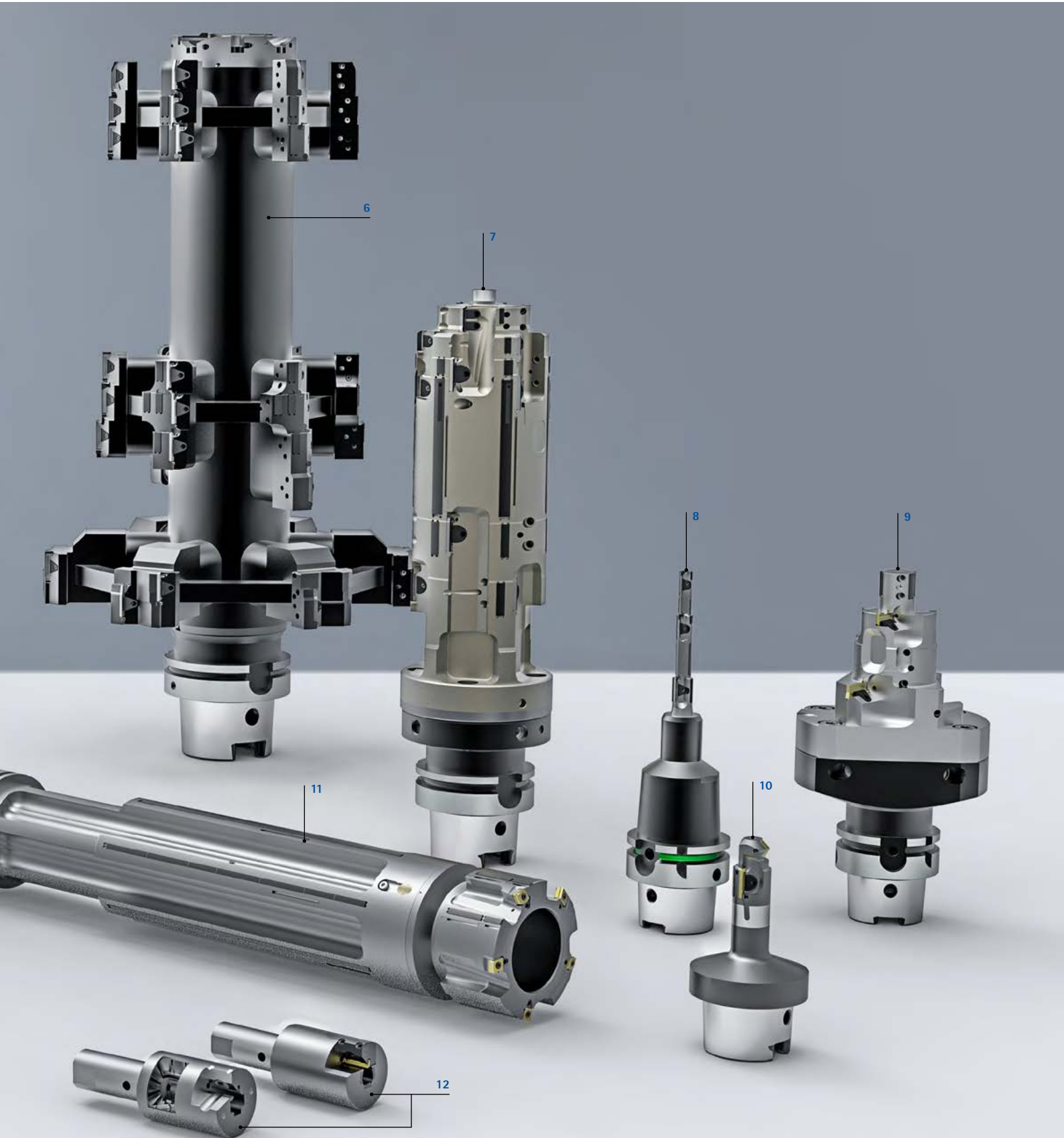

SOLUCIONES ESPECIALES

Herramientas con sistema EasyAdjust

Soluciones especiales con sistema EasyAdjust

- 1 Herramientas combinadas para el premecanizado y el mecanizado de acabado de un pie de biela grande y pequeño. Con insertos ISO para el mecanizado previo y sistema EasyAdjust para el mecanizado de acabado
- 2 Herramienta especial con sistema EasyAdjust con cuatro insertos TEC ($z = 4$) y guías de apoyo dispuestas unilateralmente, para el mecanizado de un corte fuertemente interrumpido en un cárter de bomba de GJS-400
- 3 Herramienta de seis filos en distribución de corte 4+2 con sistema EasyAdjust con insertos HX, para el mecanizado de un agujero de cilindro
- 4 Herramientas escalonadas de taladrado de precisión con sistema EasyAdjust con insertos TEC, para el mecanizado de agujeros ciegos en cajas de cambios y cámaras de válvula con exigencias IT5 e IT6 en cuanto a la precisión dimensional
- 5 Herramientas para el semimecanizado y mecanizado de acabado de un agujero de cojinete de cigüeñal fabricado con la combinación bimetálica aluminio y GJL
- 6 Escariador exterior con sistema EasyAdjust con insertos TEC, sustituye al torneado convencional de un componente de GJS con una mejor precisión dimensional



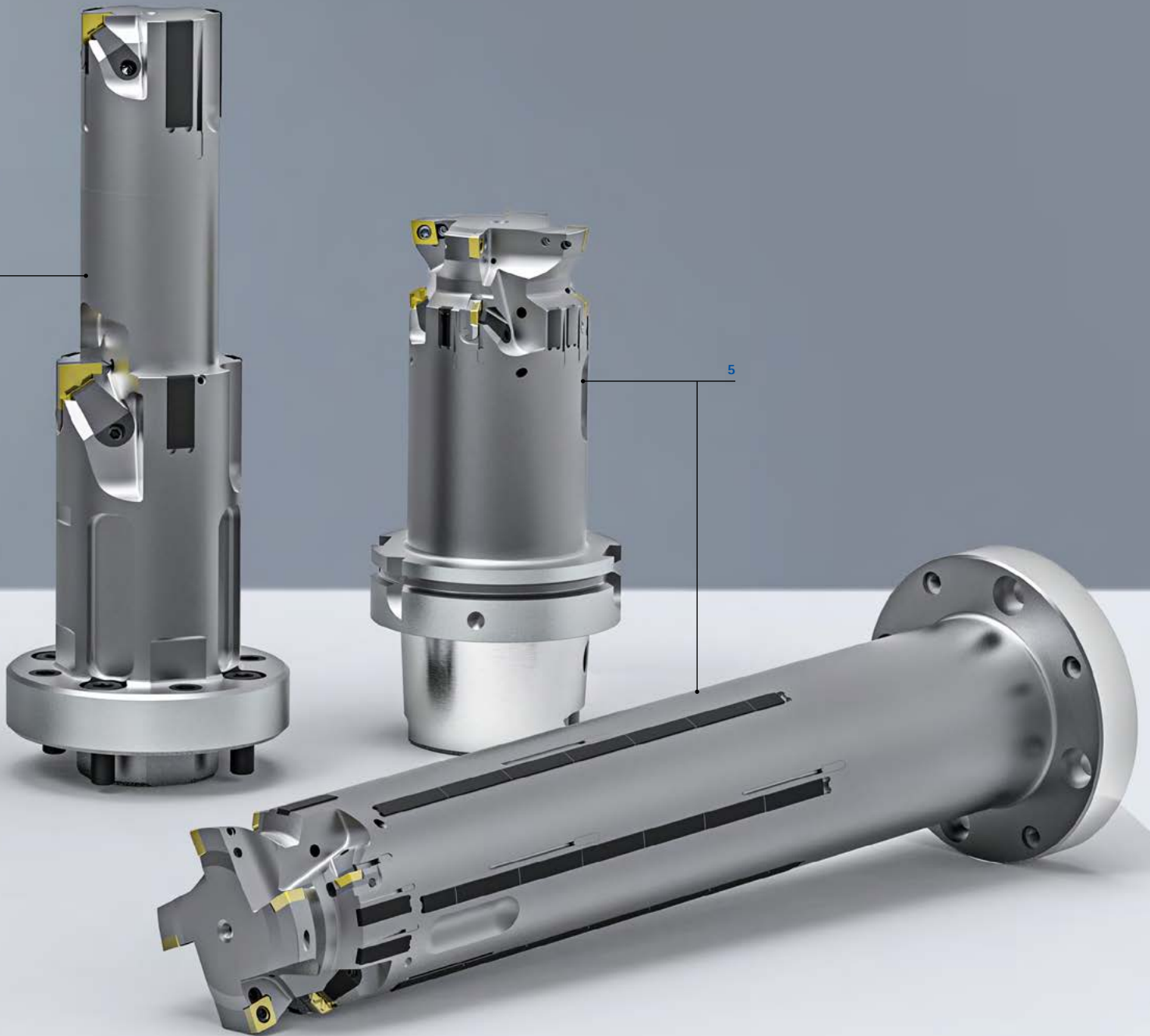

SOLUCIONES ESPECIALES

Escariador de múltiples filos

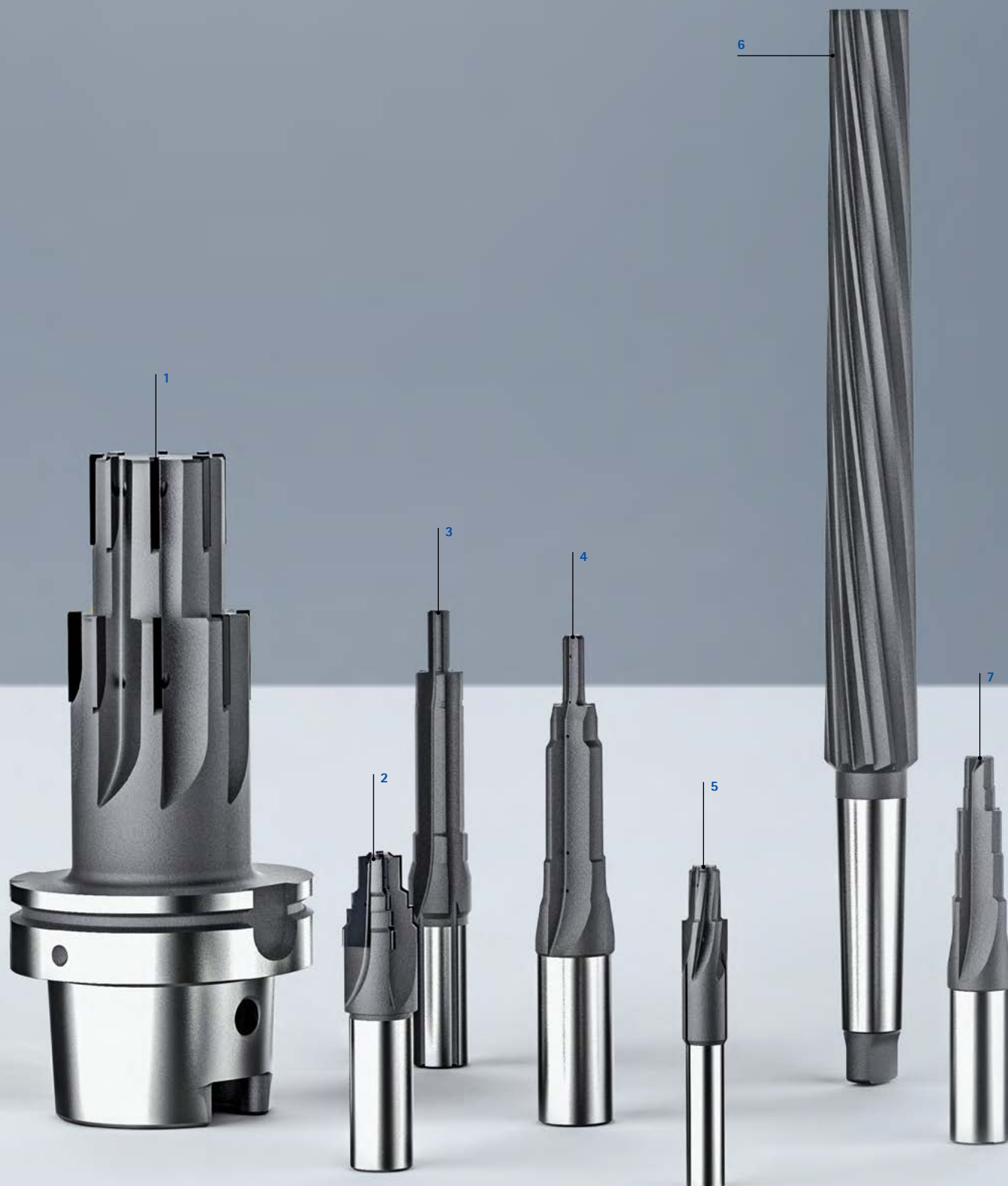

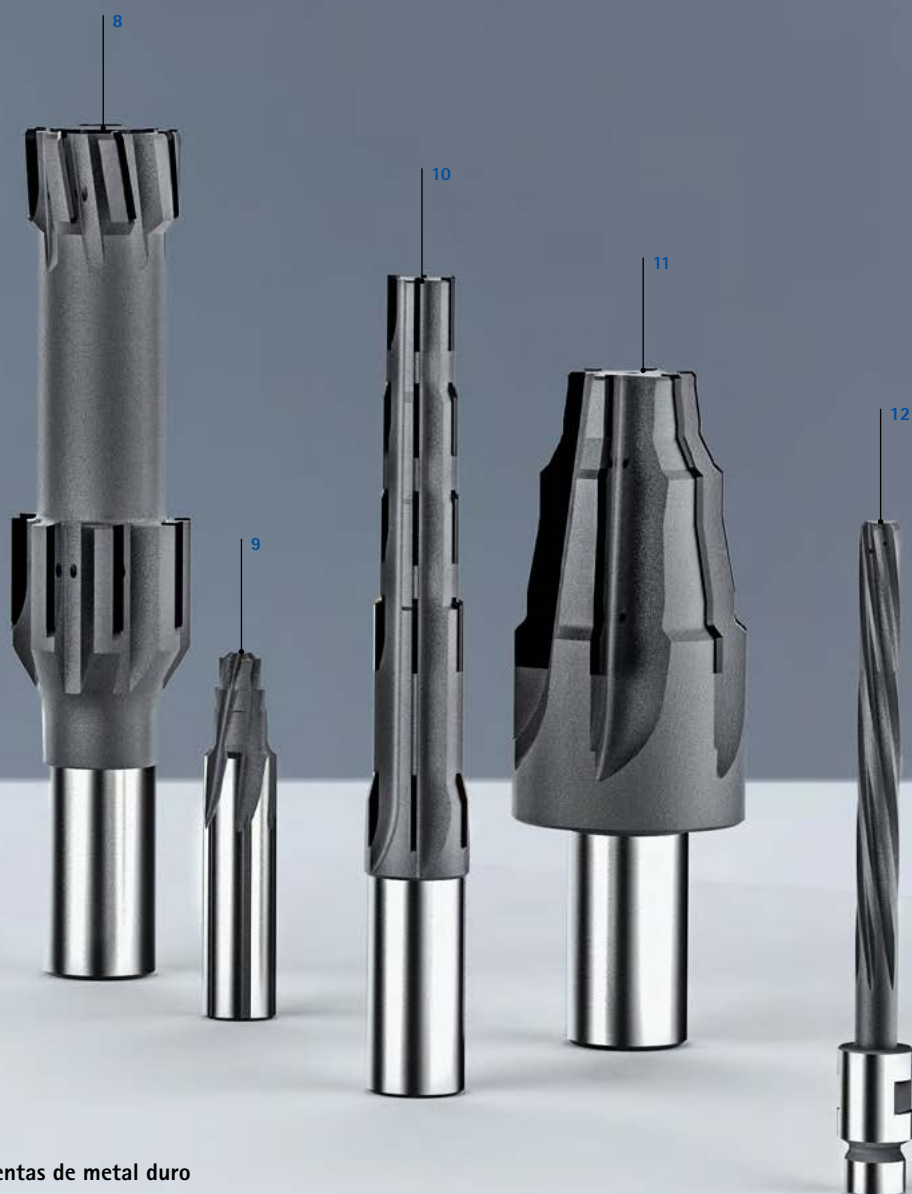

Soluciones especiales, herramientas de metal duro

- 1 Herramienta especial de dos etapas con insertos soldados, para el mecanizado de una carcasa hidráulica de EN-GJS-500-7
- 2 Herramienta especial escalonada de metal duro con recubrimiento, con mecanizado de bisel y radios de un portacilindros de acero
- 3 Escariador escalonado de metal duro con recubrimiento, para el mecanizado del orificio del inyector de una culata
- 4 Escariador escalonado de metal duro con recubrimiento, para el mecanizado de acabado del contorno del orificio de una bujía en EN-GJL-250
- 5 Escariador escalonado de metal duro de dos etapas con mecanizado adicional de bisel para una bomba de alta presión de acero inoxidable
- 6 Escariador cónico de máquina de acero rápido con mango MK
- 7 Escariador escalonado de metal duro con geometría VA, para el mecanizado de un bloque de válvulas de acero inoxidable
- 8 Escariador especial de dos etapas con filos de cermet soldados, con ejecución combinada de ranuras rectas y ranuras oblicuas a la izquierda
- 9 Escariador escalonado de metal duro con recubrimiento, con refrigeración interna en el mango para el mecanizado de un rail
- 10 Escariador escalonado con insertos de cermet semicirculares soldados integrados, para el mecanizado de un portainyector de acero
- 11 Escariador de forma de metal duro, con recubrimiento, para el mecanizado de piezas torneadas especiales
- 12 Escariador de alto rendimiento con cabezal de metal duro soldado a tope, con amarre especial para la industria aeronáutica, para el mecanizado de una combinación de agujeros de remache de titanio, aluminio y acero de alta aleación

SOLUCIONES ESPECIALES

HPR – High-Performance-Reamer





Soluciones especiales HPR

- 1 Solución especial con anillo de múltiples filos HPR modular y escariador escalonado de metal duro con portaherramientas fabricado de forma aditiva, con tecnología de sujeción hidráulica para la sujeción interior y exterior, para el mecanizado de asientos de válvula
- 2 Herramienta combinada modular escalonada con interfaz CFS integrada para herramienta CPR fija soldada, con insertos tangenciales ISO para el pre mecanizado y sistema HPR300 para el mecanizado de acabado de un caliper de freno
- 3 Herramienta escalonada especial de PCD con avellanado para el mecanizado de un componente en la industria aeroespacial
- 4 Herramienta especial HPR escalonada con interfaz HFS, para el mecanizado del agujero y avellanado de contorno de un turbocompresor de GJL250
- 5 Herramienta especial escalonada, para el mecanizado de carcasas con insertos escariadores dispuestos tangencialmente
- 6 Herramienta especial, para el mecanizado de un agujero de remache en la industria aeroespacial
- 7 Herramienta de corte a la derecha, para el mecanizado de agujeros ciegos
- 8 Herramienta especial escalonada con geometrías de corte especiales e interfaz HFS
- 9 Herramienta especial en ejecución fija con insertos soldados, para el mecanizado escalonado de transiciones planas y biseladas del orificio del actuador en el caliper de freno

SOLUCIONES ESPECIALES

Escariadores de múltiples filos para diámetros grandes

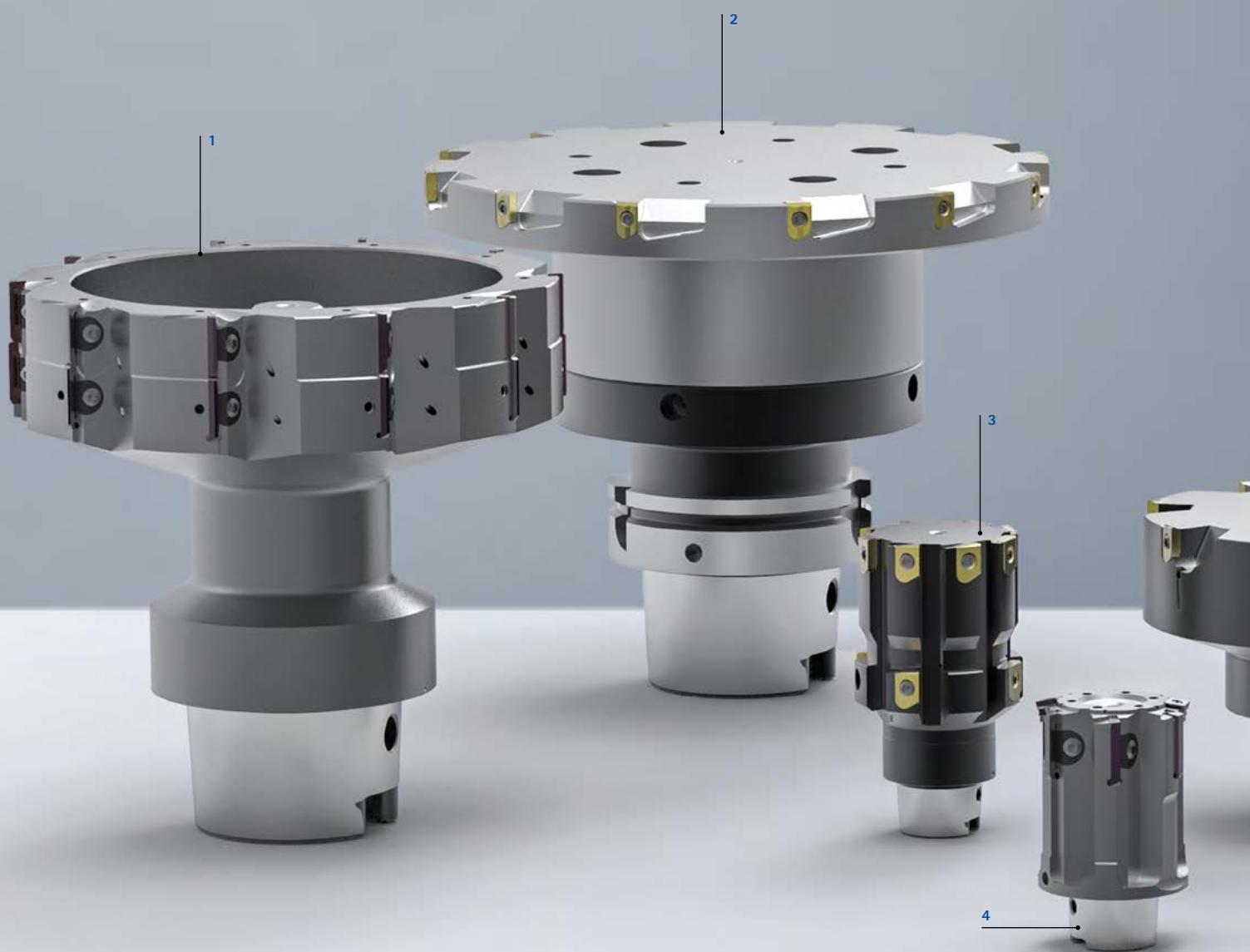

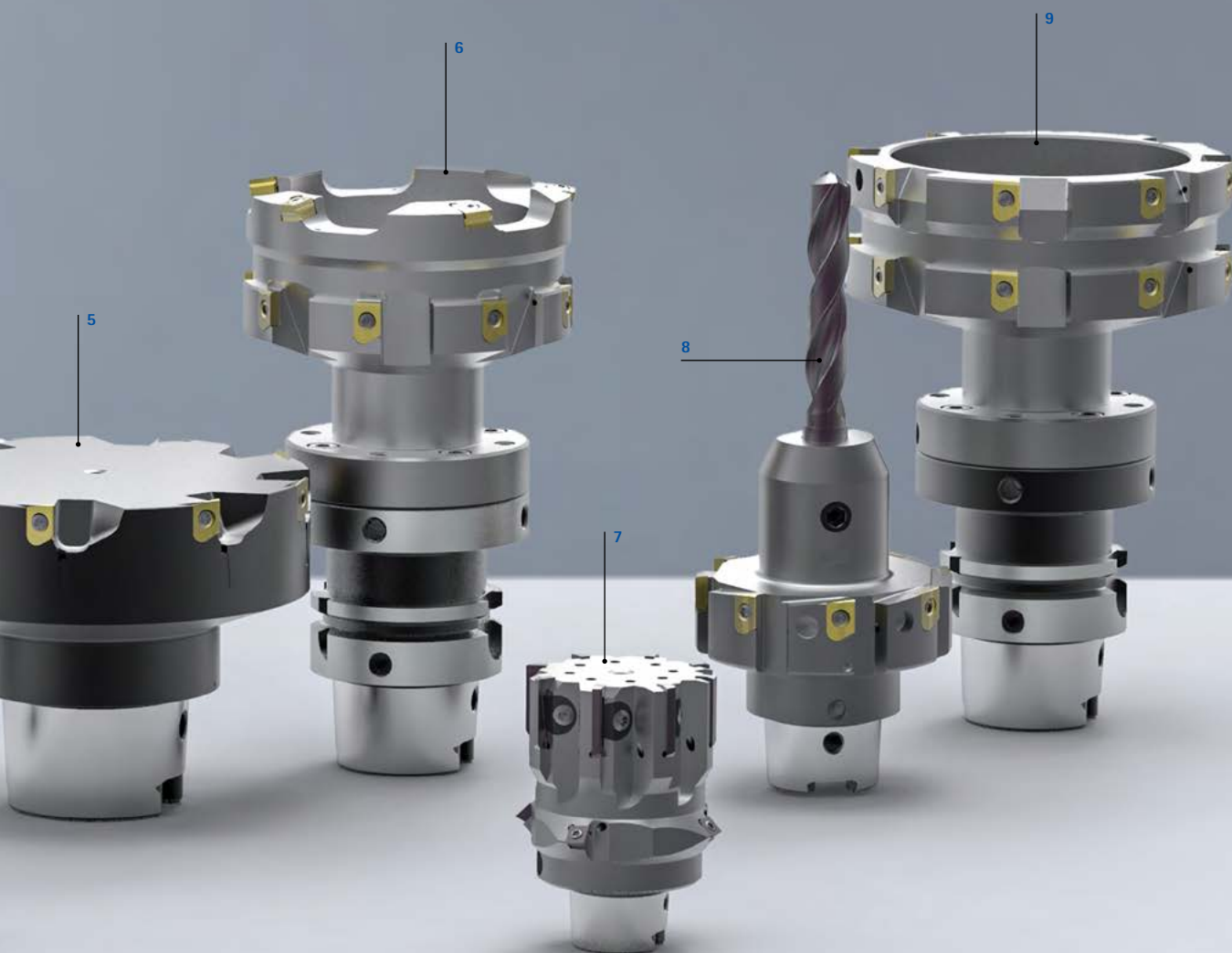

Soluciones especiales HPR300 y HPR400

- 1 Solución especial HPR300 de dos etapas, para el mecanizado del agujero del cojinete en una caja de cambios
- 2 HPR400 con insertos con recubrimiento de CVD con diámetro de 160 mm, para el mecanizado de un cárter de diferencial, con interfaz de módulo alineable
- 3 Herramienta HPR400 de dos etapas con ocho insertos para el agujero de pistón y cuatro filos para el corte de control de un caliper de freno
- 4 Herramienta combinada con plaquitas tangenciales ISO para el premechado y HPR300 con insertos de PCD para el mecanizado de acabado de un casquillo de latón
- 5 Herramienta especial HPR400 para el agujero de un puente de eje de GJS-400 con insertos especiales de CVD para el mecanizado de asientos de cojinete y para el ranurado axial
- 6 Herramienta combinada de construcción ligera con interfaz de módulo alineable con el adaptador HSK, para el mecanizado de una carcasa de piñones cónicos. Con plaquitas tangenciales ISO para el mecanizado previo y sistema HPR400 para el mecanizado de acabado
- 7 HPR300 con mecanizado de bisel
- 8 Herramienta combinada con broca fabricada por completo en metal duro como solución integrada y escalón de escariado HPR400, para el mecanizado de un cojinete giratorio
- 9 Herramienta escalonada HPR400 de construcción ligera con interfaz de módulo alineable para el mecanizado de una carcasa de accionamiento de piñones cónicos



AVELLANADO

Avellanado con avellanadores cónicos divididos de forma extremadamente irregular. Avellanado óptimo a la par que silencioso, rápido y preciso.



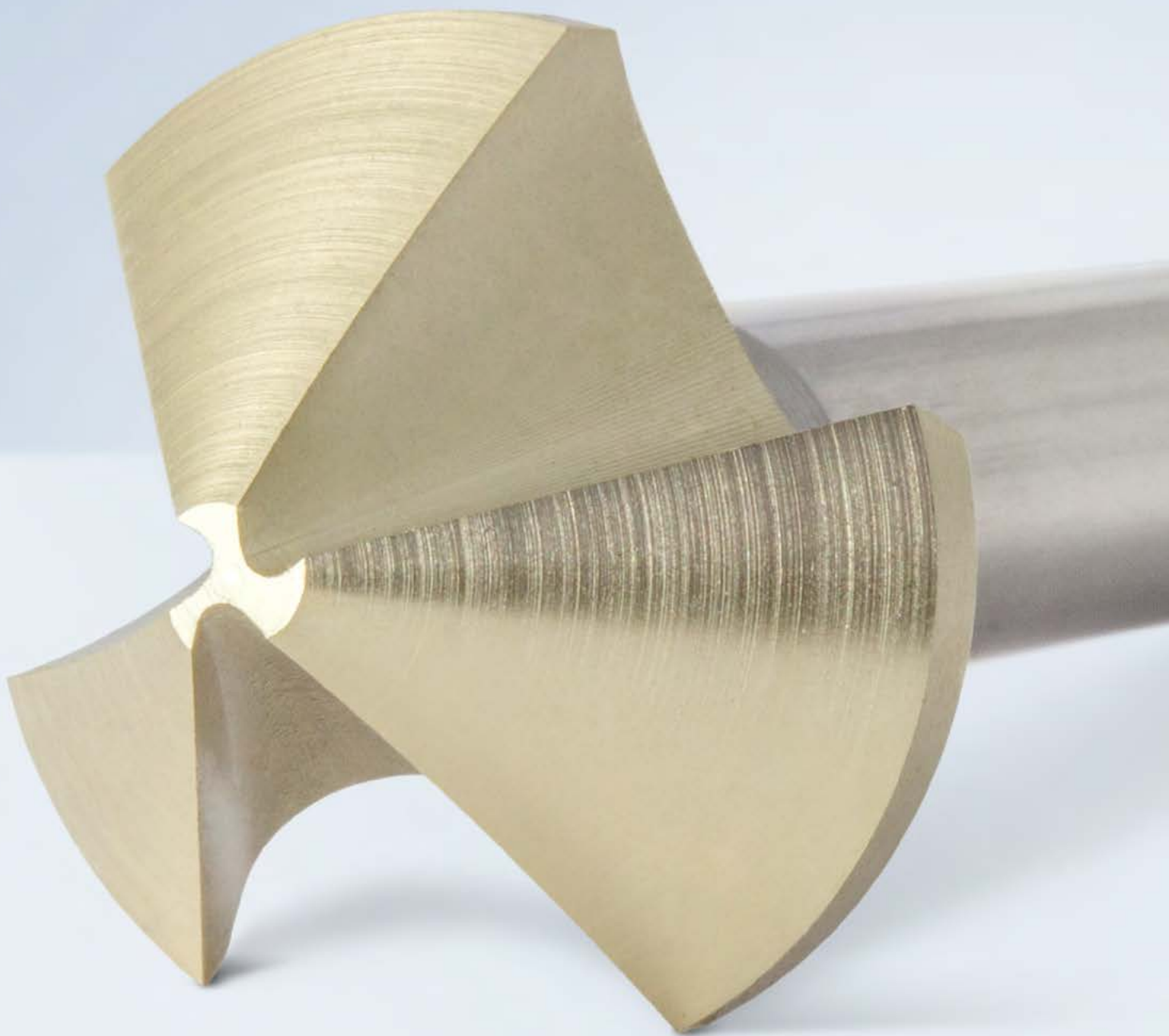

AVELLANADORES CÓNICOS DIVIDIDOS DE FORMA EXTREMADAMENTE IRREGULAR

Introducción

Tecnología 586

Avellanadores cónicos

Variante HSS con recubrimiento 588

Variante completa en metal duro (MD) con recubrimiento 589





AVELLANADORES CÓNICOS DIVIDIDOS DE FORMA EXTREMADAMENTE IRREGULAR

Por fin un proceso silencioso, rápido y preciso

Cualquier proceso de mecanizado tiene un potencial latente de aumentar la productividad. Incluso los mecanizados supuestamente secundarios ofrecen considerables potenciales de mejora. Así lo demuestran los avellanadores cónicos de MAPAL.

El avellanador cónico funciona con unas fuerzas axiales considerablemente reducidas. Sus insertos están divididos de forma desigual. Con la relación seleccionada, la fuerza axial se ha reducido más de un 50 % y la fuerza radial en un 25 % en comparación con los avella

nadores cónicos usuales. Este tipo de condiciones de uso optimizadas crean vibraciones mucho menores en la herramienta, lo que permite mayores precisiones y mejores valores superficiales. La precisión del avellanado supone una mejora directa de la instalación de las uniones atornilladas y remachadas, lo que evita la realización de la unión en estado montado, bajo carga. Además, la reducción de la carga de la máquina aumenta la vida útil de las herramientas. Las herramientas pueden funcionar con unos valores de corte superiores, gracias a su marcha suave y estable. Esto se traduce en un ahorro de tiempo considerable.



Características detalladas de la herramienta

Reducción de la fuerza radial en un 25 %

Fuerza radial N

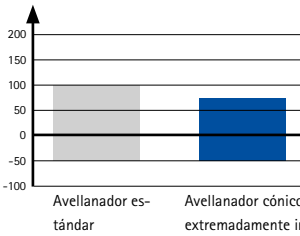

Avellanador estándar

Avellanador cónico dividido de forma extremadamente irregular

Reducción de la fuerza axial en un 50 %

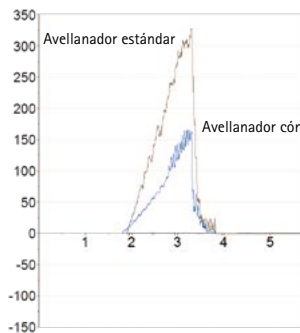

Avellanador estándar

Avellanador cónico dividido de forma extremadamente irregular

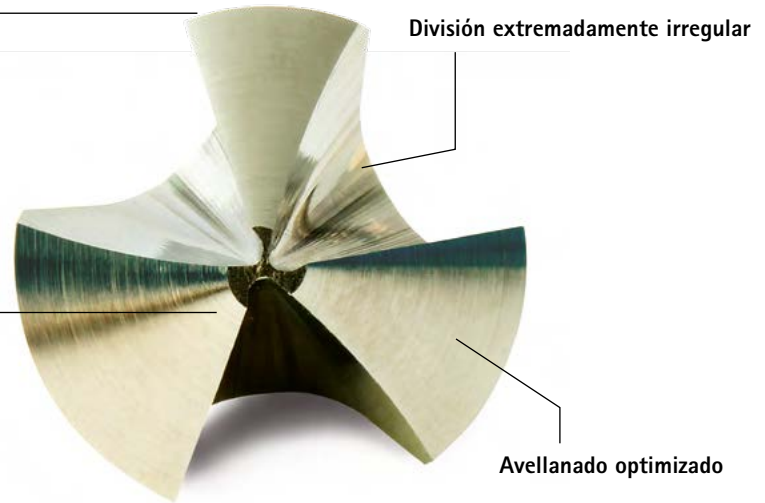

Avellanador cónico dividido de forma extremadamente irregular



Avellanador estándar

Ejecución HSS con recubrimiento



Para todos los materiales de uso habitual, como el acero, el acero inoxidable o el aluminio, los avellanadores cónicos HSS con recubrimiento de alto rendimiento son la opción perfecta. El recubrimiento proporciona una larga vida útil. Las herramientas trabajan con fiabilidad y seguridad en el proceso incluso a altas velocidades de corte. Para materiales más exigentes, se recomienda el uso de la ejecución fabricada íntegramente en metal duro.

Ejecución completa en metal duro (MD) con recubrimiento



Además de las ejecuciones HSS con recubrimiento de alto rendimiento de los avellanadores cónicos, MAPAL también ofrece diámetros seleccionados como versión fabricada íntegramente en metal duro. La ejecución fabricada íntegramente en metal duro ofrece, además de las ventajas de la división irregular, un valor añadido adicional, principalmente para el mecanizado de materiales exigentes como el titanio, la fundición de alta aleación, Inconel o CFK. La vida útil y las velocidades de corte superiores respecto a la ejecución HSS con recubrimiento se logran con seguridad en el proceso.

Ejecuciones especiales de brocas con nivel de avellanado



MAPAL ofrece la posibilidad de fabricar como solución especial con un nivel de avellanado casi todas las brocas fabricadas íntegramente en metal duro. De este modo pueden realizarse dos procesos de mecanizado, taladrado y avellanado, con solo una herramienta, y reducirse los tiempos no productivos. Las tecnologías de fabricación más modernas, así como la fabricación flexible de MAPAL, hacen posibles unos plazos de entrega cortos para soluciones especiales en el mundo entero.

Avellanadores cónicos 90°

Ejecución HSS con recubrimiento, paso extremadamente diferencial
COS110

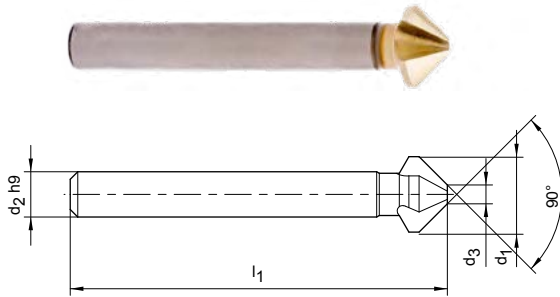

Dimensiones					Especificación	Referencia
d ₁	d ₂	d ₃	l ₁	z		
4,30	4	1,3	40	3	COS110-0430-335C-SP345	30662991
6,00	5	1,5	45	3	COS110-0600-335C-SP345	30662992
6,30	5	1,5	45	3	COS110-0630-335C-SP345	30633783
8,00	6	2,0	50	3	COS110-0800-335C-SP345	30662993
8,30	6	2,0	50	3	COS110-0830-335C-SP345	30662994
10,00	6	2,5	50	3	COS110-1000-335C-SP345	30662996
10,40	6	2,5	50	3	COS110-1040-335C-SP345	30633784
11,50	8	2,8	56	3	COS110-1150-335C-SP345	30662997
12,40	8	2,8	56	3	COS110-1240-335C-SP345	30662998
15,00	10	3,2	60	3	COS110-1500-335C-SP345	30662999
16,50	10	3,2	60	3	COS110-1650-335C-SP345	30633786
19,00	10	3,5	63	3	COS110-1900-335C-SP345	30663000
20,50	10	3,5	63	3	COS110-2050-335C-SP345	30633787
23,00	10	3,8	67	3	COS110-2300-335C-SP345	30663001
25,00	10	3,8	67	3	COS110-2500-335C-SP345	30633788
31,00	12	4,2	71	3	COS110-3100-335C-SP345	30663003



Juego de avellanadores cónicos

d ₁	Especificación	Referencia
6,30 - 25,00	COS110-6.3-25-335C-SP345-SET Juego compuesto por ∅ 6,30 mm ∅ 10,4 mm ∅ 16,5 mm ∅ 20,5 mm ∅ 25,0 mm	30634356

Medidas en mm.

Para la recomendación de valores de corte, véase al final del capítulo.

Avellanadores cónicos 90°

Ejecución completa en metal duro con recubrimiento, dividida de forma extremadamente irregular
COS110

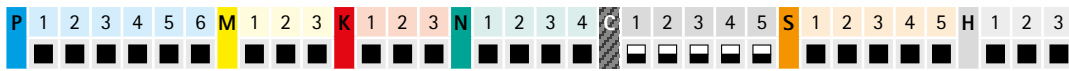
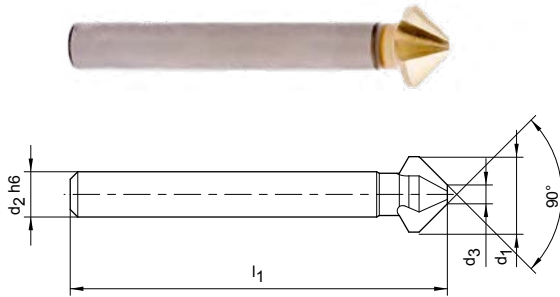

Dimensiones					Especificación	Referencia
d_1	d_2	d_3	l_1	z		
6,30	5	1,5	45	3	COS110-0630-335C-HP437	30799189
8,30	6	2,0	50	3	COS110-0830-335C-HP437	30799191
10,40	6	2,5	50	3	COS110-1040-335C-HP437	30799192
12,40	8	2,8	56	3	COS110-1240-335C-HP437	30799195
16,50	10	3,2	60	3	COS110-1650-335C-HP437	30799198
20,50	10	3,5	63	3	COS110-2050-335C-HP437	30799199
25,00	10	3,8	67	3	COS110-2500-335C-HP437	30799201
31,00	12	4,2	71	3	COS110-3100-335C-HP437	30799203

Medidas en mm.

Para la recomendación de valores de corte, véase al final del capítulo.

Recomendación de valores de corte para avellanadores cónicos

Avellanador cónico dividido de forma extremadamente irregular – Ejecución HSS con recubrimiento
Avance y velocidad de corte

Grupo de arranque de virutas de Mapal*	Material	Rigidez/dureza [N/mm ²] [HRC]
P	P1.1 Aceros de construcción, para tornos automáticos, de cementación y revenidos, no aleados	< 700
	P1.2 Aceros de construcción, para tornos automáticos, de cementación y revenidos, no aleados	< 1200
	P2.1 Aceros nitrurados, de cementación y aceros revenidos, aleados	< 900
	P2.2 Aceros nitrurados, de cementación y aceros revenidos, aleados	< 1400
	P3.1 Aceros para herramientas, rodamientos, resortes y rápidos**	< 800
	P3.2 Aceros para herramientas, rodamientos, resortes y rápidos**	< 1000
	P3.3 Aceros para herramientas, rodamientos, resortes y rápidos**	< 1500
	P4.1 Aceros inoxidables, ferríticos y martensíticos	
	P5.1 Fundición de acero	
	P6.1 Fundición de acero inoxidable, ferrítica y martensítica	
M	M1.1 Aceros inoxidables, austeníticos	< 700
	M1.2 Aceros inoxidables, ferríticos/austeníticos (dúplex)	< 1000
	M2.1 Fundición de acero inoxidable, austenítica	< 700
	M3.1 Fundición de acero inoxidable, ferrítica/austenítica (dúplex)	< 1000
K	K1.1 Hierro fundido con grafito laminar (fundición gris), GJL	< 300
	K2.1 Hierro fundido con grafito esferoidal, GJS	< 500
	K2.2 Hierro fundido con grafito esferoidal, GJS	≤ 800
	K2.3 Hierro fundido con grafito esferoidal, GJS	> 800
	K3.1 Hierro fundido con grafito vermicular, GJV; fundición maleable, GJM	< 500
	K3.2 Hierro fundido con grafito vermicular, GJV; fundición maleable, GJM	> 500
N	N1.1 Aluminio, aleado y no aleado < 3 % Si	
	N1.2 Aluminio, aleado ≤ 7 % Si	
	N1.3 Aluminio, aleado > 7-12 % Si	
	N1.4 Aluminio, aleado > 12 % Si	
	N2.1 Cobre, no aleado y de baja aleación	< 300
	N2.2 Cobre, aleado	> 300
	N2.3 Latón, bronce, fundición roja	< 1200
	N4.1 Plástico, termoplásticos	
	N4.2 Plástico, plásticos termoestables	
	N4.3 Plástico, espumas	
S	S1.1 Titanio, aleaciones de titanio	< 400
	S2.1 Titanio, aleaciones de titanio	< 1200
	S2.2 Titanio, aleaciones de titanio	> 1200
	S3.1 Níquel, no aleado y aleado	< 900
	S3.2 Níquel, no aleado y aleado	> 900
	S4.1 Superaleación de gran resistencia al calor basada en Ni, Co y Fe	
	S5.1 Aleaciones de wolframio y molibdeno	
H	H1.1 Acero templado/fundición de acero	< 44
	H1.2 Acero templado/fundición de acero	< 55

* Grupos de mecanizado MAPAL

**Si los componentes de aleación de Cr, Mo, Ni, V, W suman > 8 %, elegir el siguiente grupo de mecanizado MAPAL superior.

Página siguiente:
Ejecución completa en metal duro

	ø < 5 [mm]		ø < 5 – 8 [mm]		ø < 8 – 12 [mm]		ø < 12 – 16 [mm]		ø < 16 – 20 [mm]		ø < 20 – 25 [mm]		ø < 25 – 31 [mm]	
	v _c [m/min]	f [mm]	v _c [m/min]	f [mm]	v _c [m/min]	f [mm]	v _c [m/min]	f [mm]	v _c [m/min]	f [mm]	v _c [m/min]	f [mm]	v _c [m/min]	f [mm]
	40	0,06	40	0,08	40	0,10	40	0,12	40	0,14	40	0,18	40	0,22
	30	0,04	30	0,06	30	0,08	30	0,10	30	0,12	30	0,14	30	0,18
	30	0,04	30	0,06	30	0,08	30	0,10	30	0,12	30	0,14	30	0,18
	12	0,03	12	0,04	12	0,05	12	0,06	12	0,08	12	0,10	12	0,12
	30	0,04	30	0,06	30	0,08	30	0,10	30	0,12	30	0,14	30	0,18
	12	0,03	12	0,04	12	0,05	12	0,06	12	0,08	12	0,10	12	0,12
	15	0,04	15	0,05	15	0,06	15	0,07	15	0,08	15	0,09	15	0,12
	30	0,04	30	0,06	30	0,08	30	0,10	30	0,12	30	0,14	30	0,18
	15	0,04	15	0,05	15	0,06	15	0,07	15	0,08	15	0,09	15	0,12
	15	0,04	15	0,05	15	0,06	15	0,07	15	0,08	15	0,09	15	0,12
	10	0,04	10	0,05	10	0,06	10	0,07	10	0,08	10	0,09	10	0,12
	15	0,04	15	0,05	15	0,06	15	0,07	15	0,08	15	0,09	15	0,12
	20	0,06	20	0,10	20	0,12	20	0,14	20	0,18	20	0,20	20	0,25
	20	0,06	20	0,10	20	0,12	20	0,14	20	0,18	20	0,20	20	0,25
	20	0,06	20	0,10	20	0,12	20	0,14	20	0,18	20	0,20	20	0,25
	20	0,06	20	0,10	20	0,12	20	0,14	20	0,18	20	0,20	20	0,25
	20	0,06	20	0,10	20	0,12	20	0,14	20	0,18	20	0,20	20	0,25
	20	0,06	20	0,10	20	0,12	20	0,14	20	0,18	20	0,20	20	0,25
	50	0,08	50	0,10	50	0,12	50	0,14	50	0,18	50	0,22	50	0,26
	50	0,08	50	0,10	50	0,12	50	0,14	50	0,18	50	0,22	50	0,26
	40	0,08	40	0,10	40	0,12	40	0,14	40	0,18	40	0,22	40	0,26
	40	0,08	40	0,10	40	0,12	40	0,14	40	0,18	40	0,22	40	0,26
	40	0,10	40	0,12	40	0,14	40	0,18	40	0,20	40	0,24	40	0,30
	40	0,10	40	0,12	40	0,14	40	0,18	40	0,20	40	0,24	40	0,30
	40	0,10	40	0,12	40	0,14	40	0,18	40	0,20	40	0,24	40	0,30
	40	0,10	40	0,12	40	0,14	40	0,18	40	0,20	40	0,24	40	0,30
	40	0,10	40	0,12	40	0,14	40	0,18	40	0,20	40	0,24	40	0,30
	10	0,04	10	0,05	10	0,06	10	0,07	10	0,08	10	0,09	10	0,12
	10	0,04	10	0,05	10	0,06	10	0,07	10	0,08	10	0,09	10	0,12
	10	0,04	10	0,05	10	0,06	10	0,07	10	0,08	10	0,09	10	0,12
	10	0,04	10	0,05	10	0,06	10	0,07	10	0,08	10	0,09	10	0,12
	10	0,04	10	0,05	10	0,06	10	0,07	10	0,08	10	0,09	10	0,12
	10	0,04	10	0,05	10	0,06	10	0,07	10	0,08	10	0,09	10	0,12
	10	0,04	10	0,05	10	0,06	10	0,07	10	0,08	10	0,09	10	0,12
	6	0,04	6	0,05	6	0,06	6	0,08	6	0,08	6	0,10		
	6	0,04	6	0,05	6	0,06	6	0,08	6	0,08	6	0,10		

Los valores de corte indicados son de referencia.

Los datos óptimos para cada situación de mecanizado deben determinarse mediante ensayos o durante el propio proceso de mecanizado.

Recomendación de valores de corte para avellanadores cónicos

Avellanadores cónicos divididos de forma extremadamente irregular – Ejecución completa en metal duro con recubrimiento
 Avance y velocidad de corte

Grupo de arranque de virutas de Mapal*	Material	Rigidez/dureza [N/mm ²] [HRC]
P	P1.1 Aceros de construcción, para tornos automáticos, de cementación y revenidos, no aleados	< 700
	P1.2 Aceros de construcción, para tornos automáticos, de cementación y revenidos, no aleados	< 1200
	P2.1 Aceros nitrurados, de cementación y aceros revenidos, aleados	< 900
	P2.2 Aceros nitrurados, de cementación y aceros revenidos, aleados	< 1400
	P3.1 Aceros para herramientas, rodamientos, resortes y rápidos**	< 800
	P3.2 Aceros para herramientas, rodamientos, resortes y rápidos**	< 1000
	P3.3 Aceros para herramientas, rodamientos, resortes y rápidos**	< 1500
	P4.1 Aceros inoxidables, ferríticos y martensíticos	
	P5.1 Fundición de acero	
	P6.1 Fundición de acero inoxidable, ferrítica y martensítica	
M	M1.1 Aceros inoxidables, austeníticos	< 700
	M1.2 Aceros inoxidables, ferríticos/austeníticos (dúplex)	< 1000
	M2.1 Fundición de acero inoxidable, austenítica	< 700
	M3.1 Fundición de acero inoxidable, ferrítica/austenítica (dúplex)	< 1000
K	K1.1 Hierro fundido con grafito laminar (fundición gris), GJL	< 300
	K2.1 Hierro fundido con grafito esferoidal, GJS	< 500
	K2.2 Hierro fundido con grafito esferoidal, GJS	≤ 800
	K2.3 Hierro fundido con grafito esferoidal, GJS	> 800
	K3.1 Hierro fundido con grafito vermicular, GJV; fundición maleable, GJM	< 500
	K3.2 Hierro fundido con grafito vermicular, GJV; fundición maleable, GJM	> 500
N	N1.1 Aluminio, aleado y no aleado < 3 % Si	
	N1.2 Aluminio, aleado ≤ 7 % Si	
	N1.3 Aluminio, aleado > 7-12 % Si	
	N1.4 Aluminio, aleado > 12 % Si	
	N2.1 Cobre, no aleado y de baja aleación	< 300
	N2.2 Cobre, aleado	> 300
	N2.3 Latón, bronce, fundición roja	< 1200
	N3.1 Grafito > 8 µm	
	N3.2 Grafito < 8 µm	
	N4.1 Plástico, termoplásticos	
	N4.2 Plástico, plásticos termoestables	
	N4.3 Plástico, espumas	
	C	C1.1 Matriz de plástico, reforzada con fibras de aramida (AFK)
C1.2 Matriz de plástico (termoestable), CFK/GFK		
C1.3 Matriz de plástico (termoplástico), CFK/GFK		
C2.1 Matriz de carbono, reforzada con fibras de carbono (CFC)		
C3.1 Matriz metálica (MMC)		
C4.1 Construcción tipo sándwich, núcleo de panal (nido de abeja)		
C4.2 Construcción tipo sándwich, núcleo de espuma		
C5.1 Material compuesto (stack), material compuesto de no metal/metal no ferroso		
C5.2 Material compuesto (stack), material compuesto de no metal/metal		
C5.3 Material compuesto (stack), material compuesto de no metal/no metal		
C5.4 Material compuesto (stack), material compuesto de metal no ferroso/metal no ferroso		
C5.5 Material compuesto (stack), material compuesto de metal no ferroso/metal		
C5.6 Material compuesto (stack), material compuesto de metal/metal		
S	S1.1 Titanio, aleaciones de titanio	< 400
	S2.1 Titanio, aleaciones de titanio	< 1200
	S2.2 Titanio, aleaciones de titanio	> 1200
	S3.1 Níquel, no aleado y aleado	< 900
	S3.2 Níquel, no aleado y aleado	> 900
	S4.1 Superaleación de gran resistencia al calor basada en Ni, Co y Fe	
S5.1 Aleaciones de wolframio y molibdeno		
H	H1.1 Acero templado/fundición de acero	< 44
	H1.2 Acero templado/fundición de acero	< 55
	H2.1 Acero templado/fundición de acero	< 60
	H2.2 Acero templado/fundición de acero	< 65
	H2.3 Acero templado/fundición de acero	< 68
	H3.1 Fundición/fundición dura resistente al desgaste, GJN	

* Grupos de mecanizado MAPAL

**Si los componentes de aleación de Cr, Mo, Ni, V, W suman > 8 %, elegir el siguiente grupo de mecanizado MAPAL superior.

	ø < 5 [mm]		ø < 5 - 8 [mm]		ø < 8 - 12 [mm]		ø < 12 - 16 [mm]		ø < 16 - 20 [mm]		ø < 20 - 25 [mm]		ø < 25 - 31 [mm]	
	v _c [m/min]	f [mm]	v _c [m/min]	f [mm]	v _c [m/min]	f [mm]	v _c [m/min]	f [mm]	v _c [m/min]	f [mm]	v _c [m/min]	f [mm]	v _c [m/min]	f [mm]
	60	0,06	60	0,08	60	0,10	60	0,12	60	0,14	60	0,18	60	0,22
	50	0,04	50	0,06	50	0,08	50	0,10	50	0,12	50	0,14	50	0,18
	50	0,04	50	0,06	50	0,08	50	0,10	50	0,12	50	0,14	50	0,18
	40	0,03	40	0,04	40	0,05	40	0,06	40	0,08	40	0,10	40	0,12
	50	0,04	50	0,06	50	0,08	50	0,10	50	0,12	50	0,14	50	0,18
	40	0,03	40	0,04	40	0,05	40	0,06	40	0,08	40	0,10	40	0,12
	30	0,04	30	0,05	30	0,06	30	0,07	30	0,08	30	0,09	30	0,12
	50	0,04	50	0,06	50	0,08	50	0,10	50	0,12	50	0,14	50	0,18
	30	0,04	30	0,05	30	0,06	30	0,07	30	0,08	30	0,09	30	0,12
	30	0,04	30	0,05	30	0,06	30	0,07	30	0,08	30	0,09	30	0,12
	25	0,04	25	0,05	25	0,06	25	0,07	25	0,08	25	0,09	25	0,12
	30	0,04	30	0,05	30	0,06	30	0,07	30	0,08	30	0,09	30	0,12
	25	0,04	25	0,05	25	0,06	25	0,07	25	0,08	25	0,09	25	0,12
	50	0,06	50	0,10	50	0,12	50	0,14	50	0,18	50	0,20	50	0,25
	45	0,06	45	0,10	45	0,12	45	0,14	45	0,18	45	0,20	45	0,25
	45	0,06	45	0,10	45	0,12	45	0,14	45	0,18	45	0,20	45	0,25
	45	0,06	45	0,10	45	0,12	45	0,14	45	0,18	45	0,20	45	0,25
	35	0,06	35	0,10	35	0,12	35	0,14	35	0,18	35	0,20	35	0,25
	35	0,06	35	0,10	35	0,12	35	0,14	35	0,18	35	0,20	35	0,25
	80	0,08	80	0,10	80	0,12	80	0,14	80	0,18	80	0,22	80	0,26
	80	0,08	80	0,10	80	0,12	80	0,14	80	0,18	80	0,22	80	0,26
	60	0,08	60	0,10	60	0,12	60	0,14	60	0,18	60	0,22	60	0,26
	60	0,08	60	0,10	60	0,12	60	0,14	60	0,18	60	0,22	60	0,26
	70	0,10	70	0,12	70	0,14	70	0,18	70	0,20	70	0,24	70	0,30
	70	0,10	70	0,12	70	0,14	70	0,18	70	0,20	70	0,24	70	0,30
	70	0,10	70	0,12	70	0,14	70	0,18	70	0,20	70	0,24	70	0,30
	25	0,06	25	0,10	25	0,12	25	0,14	25	0,18	25	0,20	25	0,25
	25	0,06	25	0,10	25	0,12	25	0,14	25	0,18	25	0,20	25	0,25
	70	0,10	70	0,12	70	0,14	70	0,18	70	0,20	70	0,24	70	0,30
	70	0,10	70	0,12	70	0,14	70	0,18	70	0,20	70	0,24	70	0,30
	70	0,10	70	0,12	70	0,14	70	0,18	70	0,20	70	0,24	70	0,30
	25	0,06	25	0,10	25	0,12	25	0,14	25	0,18	25	0,20	25	0,25
	25	0,06	25	0,10	25	0,12	25	0,14	25	0,18	25	0,20	25	0,25
	25	0,06	25	0,10	25	0,12	25	0,14	25	0,18	25	0,20	25	0,25
	25	0,06	25	0,10	25	0,12	25	0,14	25	0,18	25	0,20	25	0,25
	25	0,06	25	0,10	25	0,12	25	0,14	25	0,18	25	0,20	25	0,25
	25	0,06	25	0,10	25	0,12	25	0,14	25	0,18	25	0,20	25	0,25
	25	0,06	25	0,10	25	0,12	25	0,14	25	0,18	25	0,20	25	0,25
	25	0,06	25	0,10	25	0,12	25	0,14	25	0,18	25	0,20	25	0,25
	25	0,06	25	0,10	25	0,12	25	0,14	25	0,18	25	0,20	25	0,25
	25	0,06	25	0,10	25	0,12	25	0,14	25	0,18	25	0,20	25	0,25
	25	0,06	25	0,10	25	0,12	25	0,14	25	0,18	25	0,20	25	0,25
	15	0,04	15	0,05	15	0,06	15	0,07	15	0,08	15	0,09	15	0,12
	15	0,04	15	0,05	15	0,06	15	0,07	15	0,08	15	0,09	15	0,12
	15	0,04	15	0,05	15	0,06	15	0,07	15	0,08	15	0,09	15	0,12
	15	0,04	15	0,05	15	0,06	15	0,07	15	0,08	15	0,09	15	0,12
	15	0,04	15	0,05	15	0,06	15	0,07	15	0,08	15	0,09	15	0,12
	15	0,04	15	0,05	15	0,06	15	0,07	15	0,08	15	0,09	15	0,12
	12	0,04	12	0,05	12	0,06	12	0,08	12	0,08	12	0,10		
	12	0,04	12	0,05	12	0,06	12	0,08	12	0,08	12	0,10		
	8	0,04	8	0,05	8	0,06	8	0,08	8	0,08	8	0,10		
	8	0,04	8	0,05	8	0,06	8	0,08	8	0,08	8	0,10		
	12	0,04	12	0,05	12	0,06	12	0,08	12	0,08	12	0,10		

Los valores de corte indicados son de referencia.

Los datos óptimos para cada situación de mecanizado deben determinarse mediante ensayos o durante el propio proceso de mecanizado.

MANDRINADO Y TORNEADO

Los soportes de sujeción cortos ofrecen la máxima flexibilidad para soluciones de herramientas hechas a medida. Programa ModulBore como solución modular para el mandrinado y el taladrado de precisión.

Insertos de corte radiales positivos para el mandrinado y torneado. Insertos de corte tangenciales para los requisitos de mandrinado más exigentes.



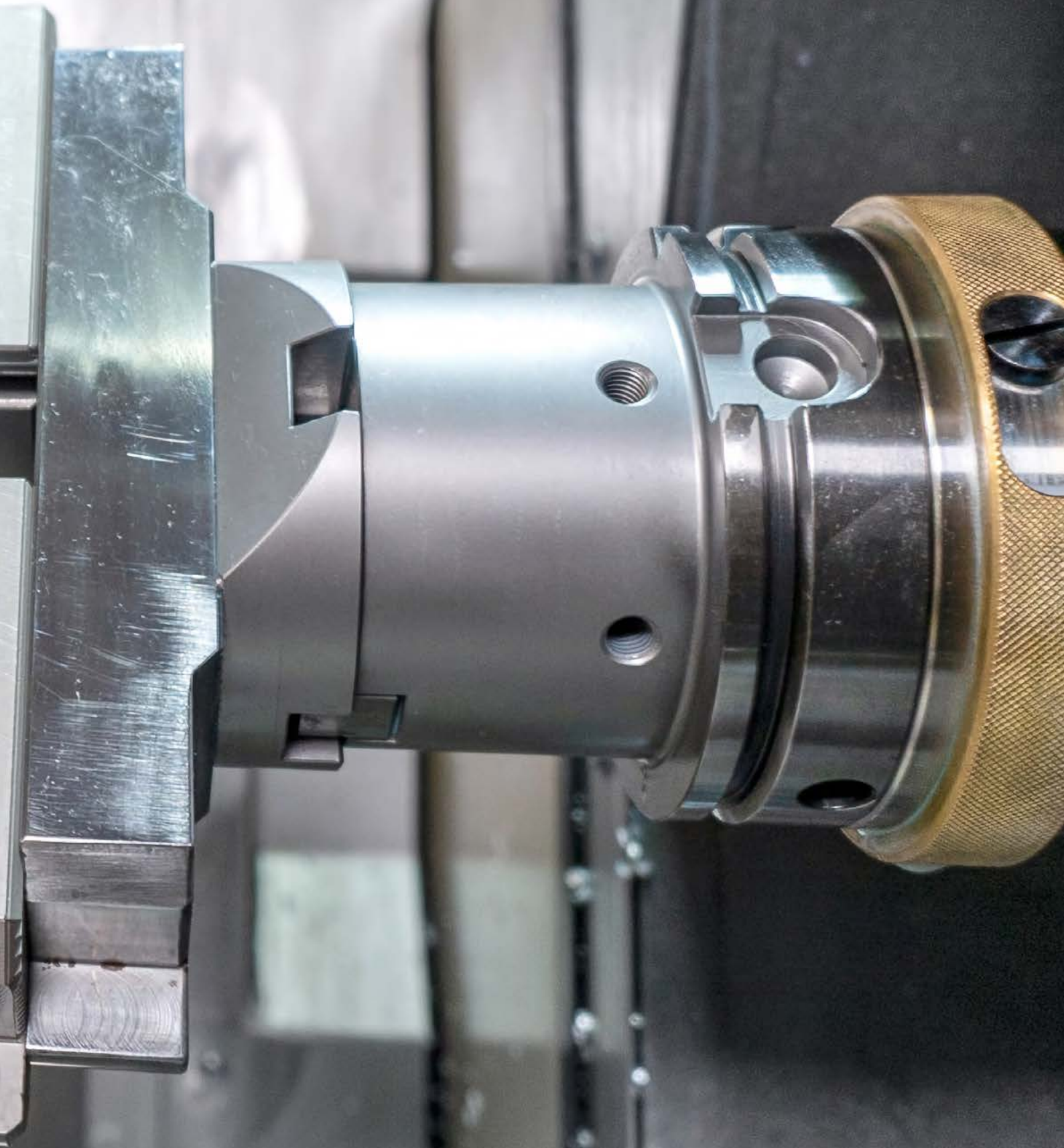

VISTA GENERAL DE LOS PRODUCTOS

Mandrinado y torneado

Las herramientas de mandrinado de MAPAL, que se encargan del paso de mecanizado entre el barrenado en solido y el mecanizado de precisión, presentan una combinación óptima de resistencia, teniendo en cuenta las fuerzas de mecanizado generadas, y una alta rentabilidad. Mediante una tecnología innovadora y una precisión absoluta, MAPAL ofrece una amplia gama de herramientas especiales con insertos de corte y insertos de PCD fijos soldados. La comprensión del proceso de mecanizado de viruta completo y de la puesta en marcha de la producción permiten, en general, un progreso real.

Con el programa estándar ModulBore, MAPAL ofrece un sistema completo para los mecani-

zados previo y de acabado de agujeros con un rango de diámetro de 6 a 1000 mm. Los soportes de sujeción cortos, con su sencillo ajuste, ofrecen numerosas posibilidades en diversas aplicaciones. El programa estándar es compatible con todos los insertos de corte ISO habituales y cubre una gran parte de las variantes de montaje constructivas.

La oferta de placas de corte con ejecución especial e insertos de corte tangenciales y radiales, cubre todos los requisitos en cuanto a materiales de corte y recubrimientos, así como las correspondientes geometrías de corte y precisiones. También hay disponibles placas de corte de PCD y metal duro para aplicaciones de torneado.



Soluciones especiales



Mandrinado con PCD

- Soluciones de herramientas individuales para tareas de mecanizado exigentes
- Máxima calidad de mecanizado en términos de dimensión, superficie y forma
- Realización de geometrías de filos complejas
- Herramientas en espiral para mecanizar componentes y configuraciones de sujeción delicadas o inestables
- Tolerancias de fabricación $\leq 3 \mu\text{m}$ para los diámetros de herramienta
- El modelo multietapa garantiza la coaxialidad en los agujeros escalonados
- Herramientas de mandrinado como herramienta combinada para reducir los tiempos no productivos
- Optimizado para el uso con lubricación minimizada (MQL)



Mandrinado con insertos de corte

- El diseño multietapa reduce las herramientas necesarias y acorta el tiempo de mecanizado
- Rendimiento superior mediante el uso de la tecnología tangencial
- Las guías de apoyo proporcionan una precisión de posición muy alta
- Guías de apoyo con resorte para el mecanizado seguro de grandes profundidades de taladrado
- Las herramientas híbridas combinan diferentes sistemas de herramientas
- Los amortiguadores de vibraciones proporcionan una calidad de mecanizado y vida útil superiores en situaciones de mecanizado inestables o de grandes longitudes de voladizo



Placas de corte con ejecución especial

- Realización de geometrías y contornos complejos para casi todas las aplicaciones
- Insertos perfilados para el mecanizado de contornos complejos con una alta precisión de forma
- Modernos equipos de fabricación garantizan la máxima precisión y flexibilidad de los insertos especiales MAPAL
- Materiales de corte eficaces para cualquier material
- También las placas de corte equipadas con PCD y PcBN están disponibles



Programa estándar



ModulBore

- Rango de diámetro de 6 a 1000 mm
- Gran flexibilidad gracias a la estructura modular
- Con una herramienta pueden mecanizarse rangos de diámetros mayores
- Suministro de refrigerante interior para una óptima retirada de virutas
- Disponible con ajuste de precisión (ModulBore-Plus)
- El dentado frontal garantiza un sistema estable y potente
- Variante con soportes de sujeción cortos ISO para mecanizar grandes diámetros



Soporte de sujeción corto

- Gran flexibilidad gracias a la capacidad de cambio rápido y sencillo
- Posibilidad de ajuste con gran recorrido de ajuste
- Compatible con todos los insertos de corte ISO convencionales
- Adecuado tanto para mecanizados exteriores como interiores
- Disponible en diferentes variantes de montaje
- También disponible como soporte de sujeción compacto de longitud más corta

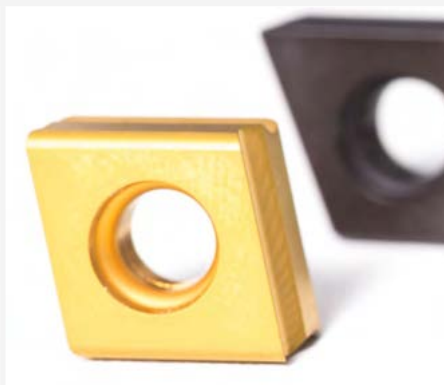

Insertos de corte

- Filos radiales positivos para el mandrinado y torneado
- Insertos de corte tangenciales para los requisitos más exigentes
- Disponibilidad de insertos afilados y prensados
- Los materiales de corte de PVD y CVD cubren un amplio rango de resistencia al desgaste y tenacidad
- Variantes equipadas con PCD y PcBN para el mecanizado altamente rentable de aluminio o fundición

SOLUCIONES ESPECIALES

Mandrinado con PCD

Cuando deben mecanizarse grandes cantidades de componentes de aluminio y fundición a presión de aluminio de forma rentable y fiable, la primera opción son las soluciones especiales con insertos de PCD. Mediante el uso de modernos controles CNC y tecnología láser, actualmente es posible producir prácticamente cualquier geometría de los filos de forma segura, con unas tolerancias de fabricación $\leq 3 \mu\text{m}$ para el diámetro de la herramienta.

Resulta especialmente rentable la combinación de varias tareas de mecanizado en una herramienta. El ahorro de herramientas y la reducción de tiempos no productivos aumentan la rentabilidad en la producción.

La fabricación de un agujero escalonado en el que tienen que mecanizarse todos los biseles y radios se soluciona con una herramienta de mandrinado de PCD con varias etapas. De este modo se garantiza la coaxialidad de cada una de las etapas. También el mecanizado de ranuras axiales o el avellanado plano de superficies de apoyo pueden solucionarse económicamente con una herramienta de taladrado. Los requisitos de planicidad o las precisiones angulares pueden alcanzarse mucho más fácilmente que con los movimientos giratorios o circulares convencionales, ya que no actúan fuerzas radiales sobre la pieza.

MAPAL fabrica herramientas de PCD en espiral con ventajas esenciales respecto a las herramientas con ranuras rectas. Las herramientas pueden diseñarse con flexibilidad para el proceso correspondiente, por ejemplo, para la lubricación minimizada. Las ejecuciones HSK y los sistemas modulares orientables proporcionan unos resultados óptimos.



Soluciones especiales



Diamante policristalino: PCD

- PCD como material de corte para el mecanizado de aluminio, metales no ferrosos, CFK y otros materiales modernos
- Producido sintéticamente a partir de partículas de diamante seleccionadas
- Sinterizado a aprox. 1500 °C y a una presión de aprox. 60 kbar
- Estructura extremadamente dura y resistente al desgaste
- Los diferentes sustratos básicos permiten siempre seleccionar el material de corte adecuado para la aplicación correspondiente



Centro de competencias para PCD

- Centro de competencias de herramientas de PCD de MAPAL en Pforzheim
- Principal centro de desarrollo y producción mundial de herramientas de PCD
- Los altos estándares de calidad, junto con los empleados altamente cualificados, garantizan resultados de producción de primer nivel
- Uso de las tecnologías de fabricación de última generación
- Introducción a la tecnología láser



Máxima precisión

- Cuchillas de PCD afiladas con la máxima precisión micrométrica
- Tolerancias de fabricación $\leq 3 \mu\text{m}$ para los diámetros de herramienta
- Máxima calidad de mecanizado en términos de dimensión, superficie y forma
- Los rompevirutas, divisores de virutas y formadores de virutas mecanizados por láser facilitan una óptima retirada de virutas y evitan el estancamiento de las mismas
- Estructura modular para una máxima precisión de concentricidad
- Ajuste preciso y seguro de la concentricidad gracias a las posibilidades de regulación axiales y radiales

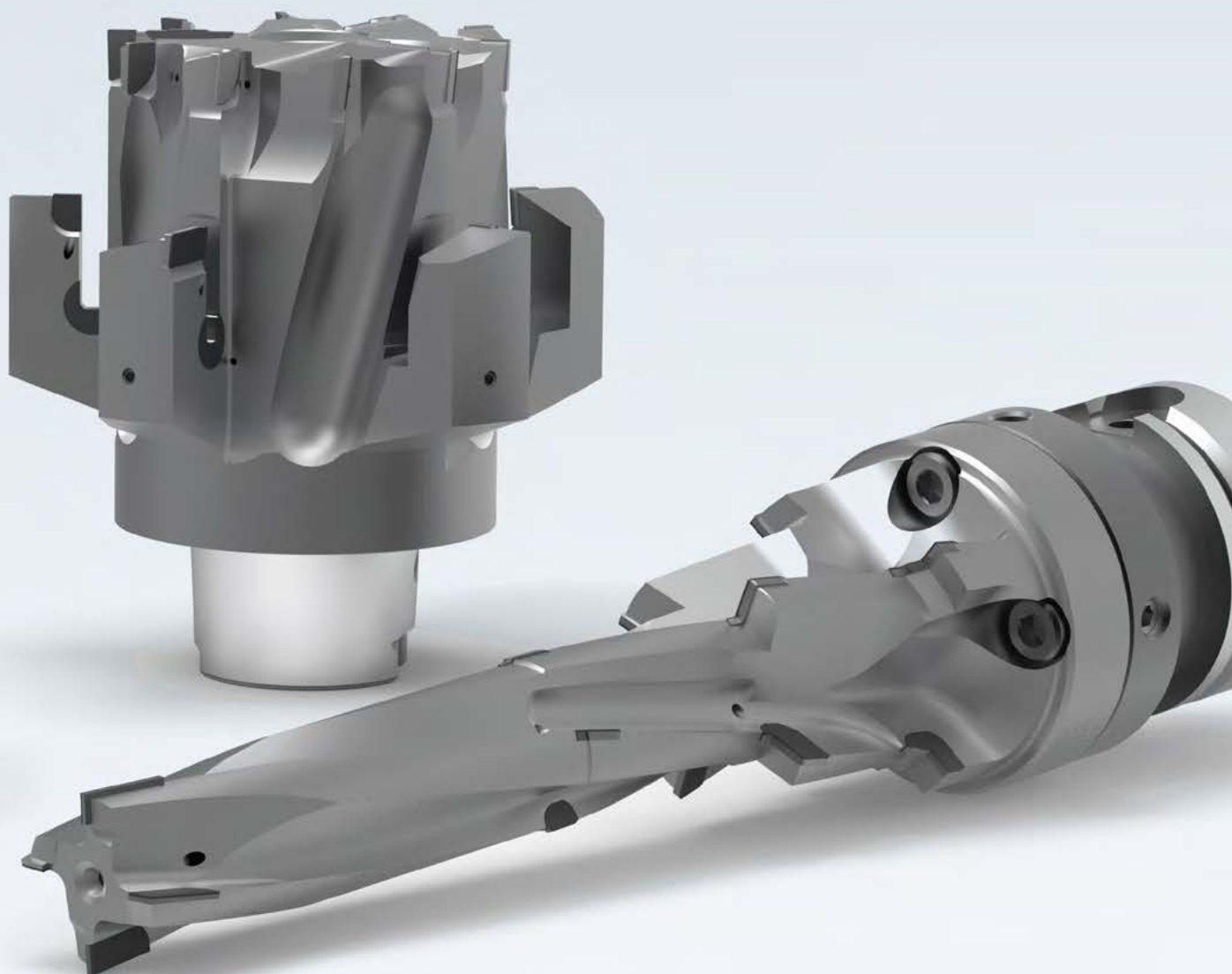

Geometrías complejas

- El mecanizado por láser permite la fabricación precisa de geometrías de corte altamente complejas, así como la realización de unos ángulos de hélice y de desprendimiento extremos
- Ventajas de las herramientas de mandrinado de PCD en espiral respecto a sus equivalentes con ranuras rectas
 - Buen comportamiento de guiado y calidades de mecanizado muy altas
 - Los ángulos de desprendimiento muy positivos reducen las fuerzas de corte necesarias
 - Ideal para mecanizar componentes y configuraciones de sujeción delicadas o inestables
 - Mejor transporte de virutas mediante la ejecución de ranuras



Soluciones innovadoras

- Desarrollo de soluciones fiables a partir de las eficientes estrategias de mecanizado como, por ejemplo, la lubricación minimizada (MQL)
- Las herramientas combinadas reducen la cantidad de pasos de proceso y los tiempos no productivos
- Las herramientas de mandrinado de PCD con varias etapas garantizan la coaxialidad en los agujeros escalonados
- Segmentos de PCD integrados con precisión
- Adaptación exacta a la geometría respectiva de las etapas



Reacondicionamiento

- El reacondicionamiento prolonga considerablemente la vida útil de las herramientas de mandrinado de PCD
- Se ahorran los costes de nuevas herramientas
- Herramientas listas para su uso
- Se alcanza sin problemas la vida útil especificada
- Recogida y entrega directas por parte del servicio de mensajería
- Proceso estandarizado para una tramitación rápida y sin complicaciones en pocos días

SOLUCIONES ESPECIALES

Mandrinado con PCD (1/2)

Ejemplos de aplicación de las soluciones especiales con PCD

- 1 Herramienta de mandrinado con placas de corte de PCD soldadas fijamente e insertos de corte estándar intercambiables con opción de ajuste para la realización de agujeros con IT6 y rugosidades definidas
- 2 Herramienta de mandrinado escalonado con mecanizado de retroceso ajustable y cambiante para mecanizar un cárter de diferencial de aluminio
- 3 Herramienta de mandrinado combinada para el mecanizado de una bomba de aceite con herramienta de inserción de metal duro intercambiable
- 4 Herramienta de mandrinado de varias etapas para el mecanizado de un cárter/tubo de dirección de AISi9Cu3. Gracias al cuerpo de titanio, la herramienta solo pesa 5,5 kg, pese a su gran tamaño
- 5 Herramienta de mandrinado de construcción ligera para el mecanizado de una placa base de compresor de AISi9Cu3. Gracias al reducido peso de la herramienta son posibles unos valores de corte altos y se descarga el husillo
- 6 Herramienta de mandrinado escalonada en espiral para mecanizar un cárter de dirección de AISi9Cu3 con interfaz de módulo orientable. Mediante el diseño en espiral se logra un corte muy suave y un transporte mecánico de las virutas
- 7 Herramienta de mandrinado escalonada para mecanizar el agujero del cojinete con ajuste de precisión integrado para el piloto de un agujero de árbol de levas en una cubierta de culata de AISi9Cu3Fe para el proceso con lubricación minimizada

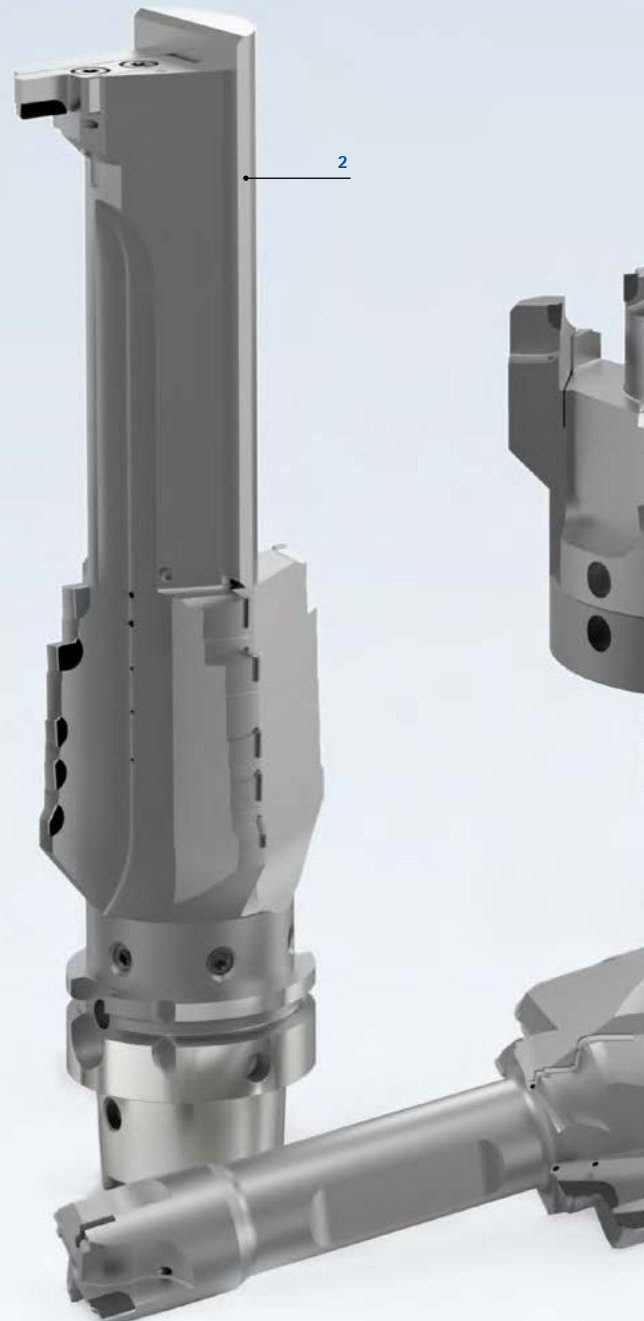



SOLUCIONES ESPECIALES

Mandrinado con PCD (2/2)

Ejemplos de aplicación de las soluciones especiales con PCD

- 1 Herramienta de taladrado y fresado de varias etapas para el mecanizado de una rótula de dirección (Steering knuckle) de aluminio. Los filos de corte integrados garantizan unas superficies sin vibraciones y así se mantienen todas las tolerancias tanto en las operaciones de taladrado como de fresado
- 2 Herramienta de campana con insertos de PCD soldados en estructura ligera para el mecanizado exterior de conexiones de mangueras. La estructura de panel del interior de la herramienta reduce significativamente el peso, lo que permite obtener mayores datos de corte. Además, la estructura de panel tiene un efecto amortiguador que repercute positivamente en la vida útil
- 3 Herramienta combinada de taladrado y fresado con insertos de PCD e insertos de corte ISO de metal duro para mecanizar un marco trasero de AlSiMg0.3. Los insertos sometidos a la mayor carga son sustituibles
- 4 Herramienta de taladrado en macizo escalonada en espiral con tres filos para el mecanizado del agujero de tornillo de una llanta de aluminio
- 5 Solución de herramienta «en un paso» con amortiguador de vibración integrado para el mecanizado de un actuador de retroalimentación de la dirección
- 6 Fresa circular con número de insertos 1+1+1 para el mecanizado de una carcasa térmica de AL380
- 7 Herramienta de mandrinado de PCD de varias etapas para el «mecanizado en un paso» de un cárter de motor eléctrico de AISi9Cu3Fe de construcción hueca para utilizar en máquinas herramienta muy estables y potentes
- 8 Herramienta de mandrinado escalonada para el mecanizado interior y exterior de una caja de cambios de AISi9Cu3Mg

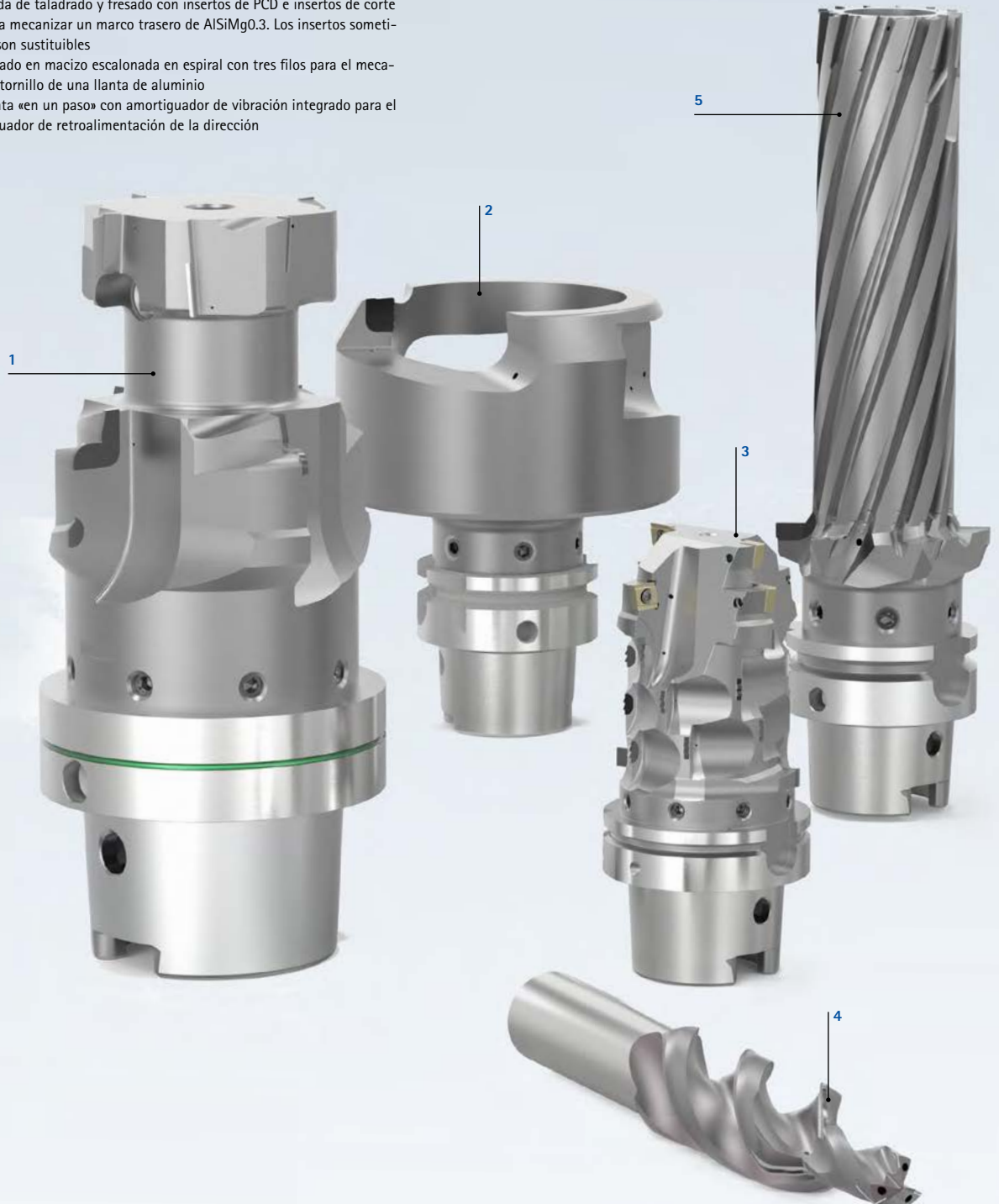

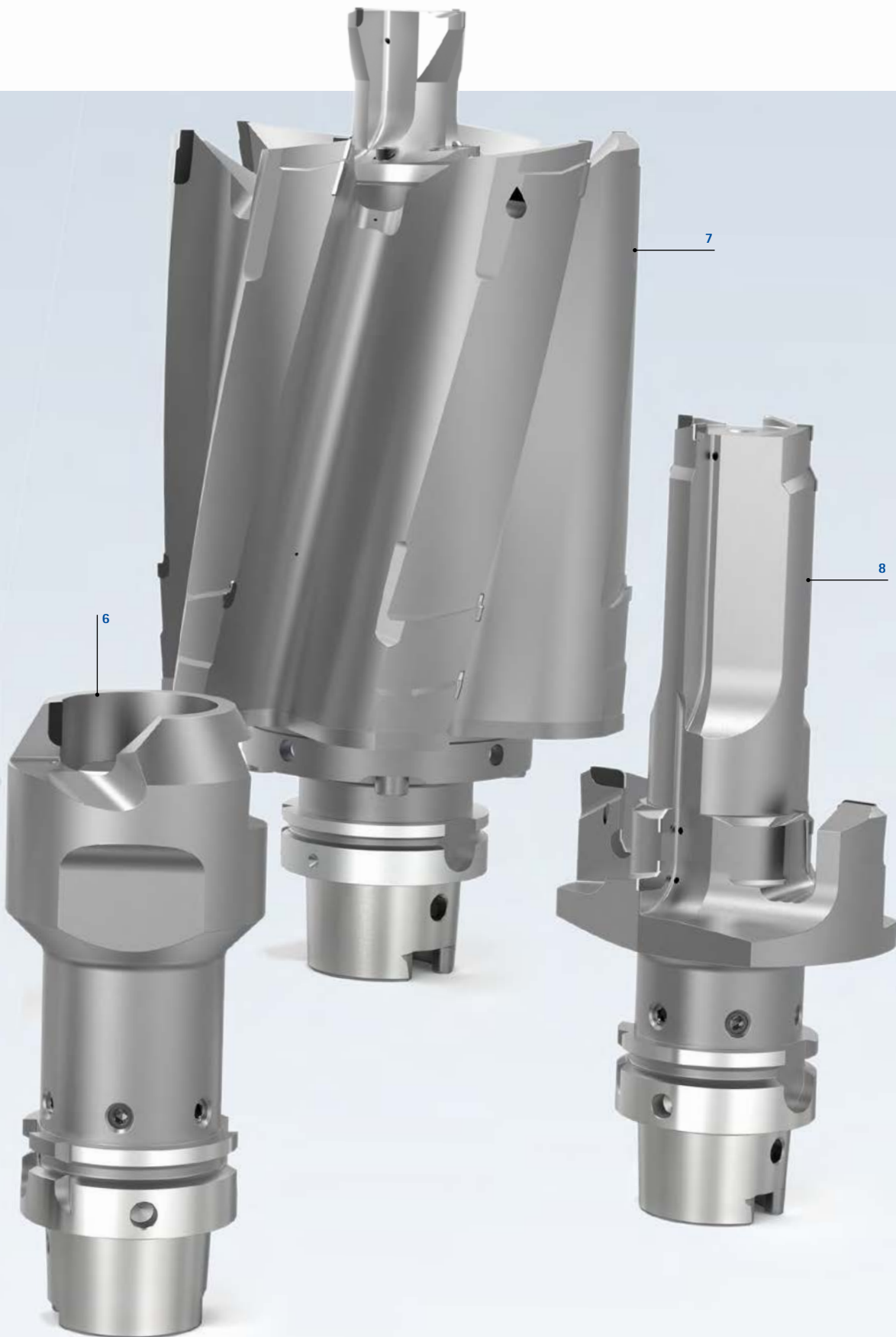

SOLUCIONES ESPECIALES

Mandrinado con insertos de corte

Dos de los principios de la planificación de nuevos procesos de mecanizado y de la optimización de los procesos existentes, son la observación del tiempo de mecanizado y el coste por pieza (CPP). Mediante herramientas combinadas o de mecanizado completo inteligentes, multietapa, de varios filos y con insertos de corte, pueden reducirse considerablemente los tiempos principales y los tiempos no productivos. Para crear una solución óptima para el cliente se combinan diferentes sistemas de arranque de viruta en las denominadas herramientas híbridas.

Las herramientas con insertos de corte de MAPAL cumplen tanto el requisito de seguridad en el proceso como también el requisito de manejo sencillo, con unas soluciones de adaptadores inteligentes y precisas y unas posibilidades de montaje rápido y seguro de insertos de corte.

El funcionamiento seguro de las herramientas con insertos de corte está garantizado por los métodos de diseño más modernos, que permiten observaciones de colisión o la determinación de los contornos de interferencia en la fase de planificación. La producción en las instalaciones de fabricación más modernas garantiza la máxima precisión de las herramientas.

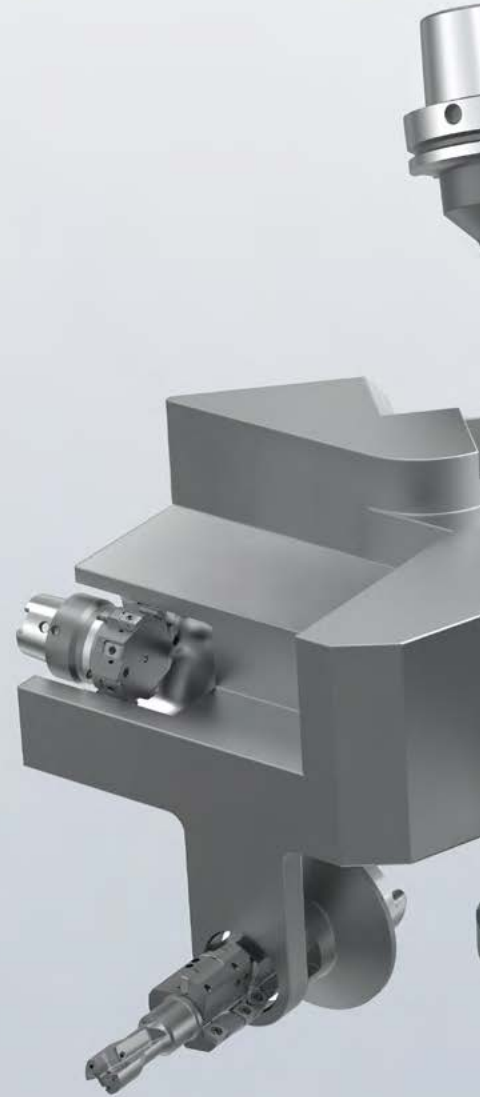

Soluciones especiales



Soluciones de procesos

- Las potentes herramientas de mecanizado completo reducen simultáneamente los tiempos principales y los no productivos
- Los procesos optimizados reducen el tiempo de mecanizado en hasta un 60 %
- Reducción de los tiempos de ciclo
- Menos consumo de energía
- Alta rentabilidad



Diseño y fabricación

- El diseño 3D más moderno y los estudios asistidos por ordenador permiten el desarrollo y diseño de herramientas tangenciales complejas
- Asientos de los insertos y espacios para virutas exactamente definidos
- Fabricación con centros de mecanizado de 5 ejes de alta precisión y rendimiento
- Supervisión y control por parte de empleados experimentados
- Cumplimiento de tolerancias de fabricación altamente precisas
- Aprovechamiento real de todos los filos y alto rendimiento de las herramientas



Estructura modular

- Diseño modular de las herramientas combinadas con insertos de corte
- Mecanizado de familias enteras de componentes con pocas herramientas
- En caso de desgaste, solo hay que sustituir la parte de la herramienta que está desgastada
- En lo que a la fabricación se refiere, pueden crearse herramientas especialmente complejas mediante el uso de uniones, por ejemplo, a través de una unión HSK-C altamente precisa
- Se combinan varios pasos de mecanizado en una herramienta
- Aumento de la productividad

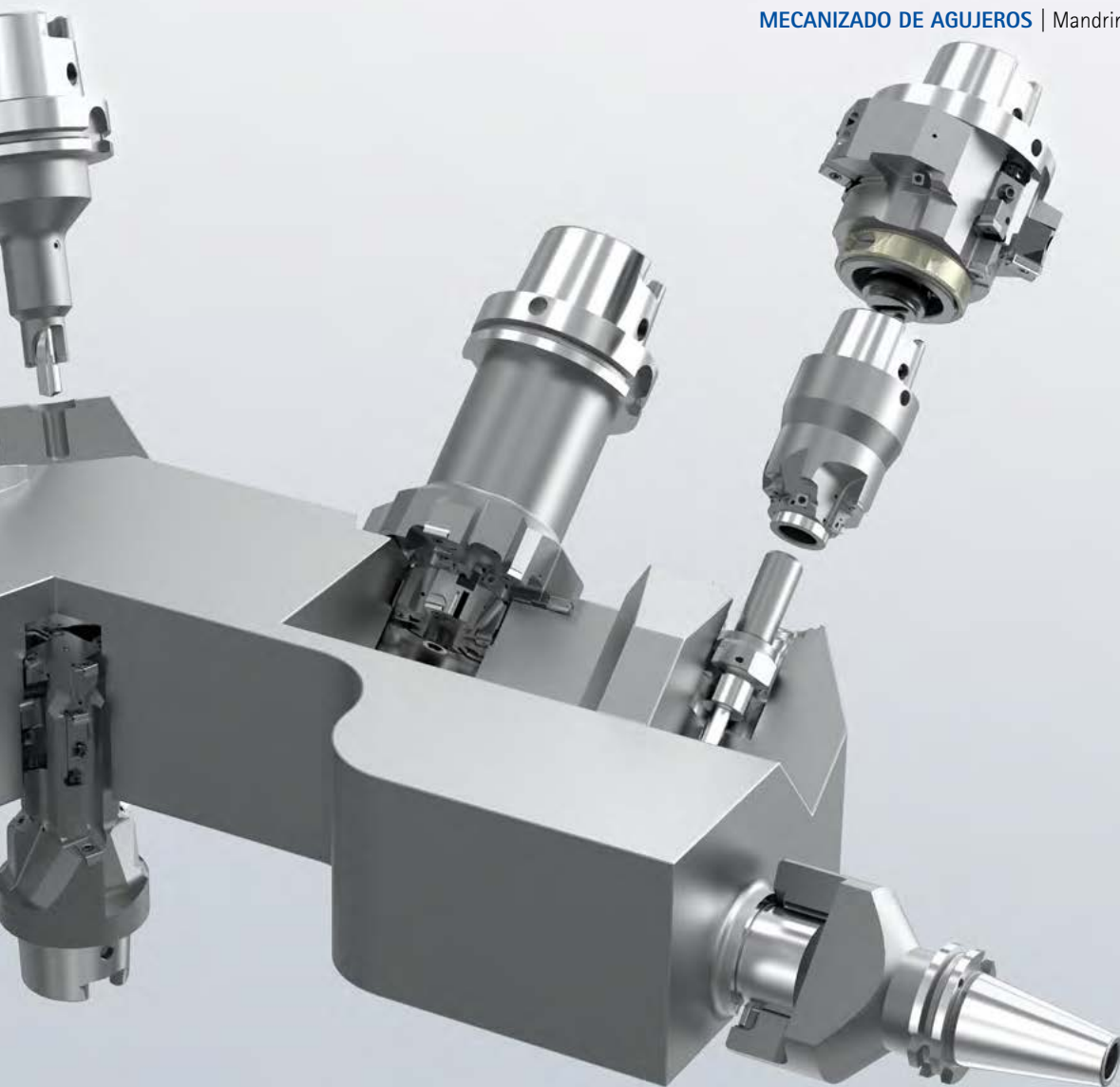

Tecnología tangencial

- Tecnología tangencial para un alto rendimiento de las herramientas de mandrinado con insertos de corte
- Se pueden usar más insertos con el mismo consumo de energía, en comparación con los insertos de corte montados radialmente
- Valores de trabajo superiores y un mayor volumen de mecanizado de virutas
- Gran suavidad de marcha
- Excelente duración de las herramientas y gran calidad de los componentes



Insertos

- Amplia variedad de geometrías y materiales de corte
- El inserto perfecto para cada aplicación
- Diferentes formas y tamaños
- Todos los materiales de corte, como el metal duro, la cerámica y los insertos de corte equipados con PCD o PcBN
- Alta rentabilidad y eficiencia de los recursos
- Aprovechamiento óptimo del material de corte con hasta ocho filos de corte



Ajuste exacto

- Sistema de ajuste especialmente desarrollado para un ajuste altamente preciso de los insertos
- Apoyo estable mediante una cuña de ajuste integrada completamente en el cuerpo de la herramienta
- El inserto descansa sobre la cuña de ajuste, que dispone de un chaflán y puede moverse por medio de un tornillo roscado izquierda-derecha
- El tornillo roscado izquierda-derecha permite un ajuste muy preciso y es fácil de utilizar

SOLUCIONES ESPECIALES

Mandrinado con insertos de corte (1/2)

Ejemplos de aplicación de las soluciones especiales con insertos de corte

- 1 Mecanizado del agujero del rotor en la carcasa del compresor de GJL con amortiguador de vibración
- 2 Herramienta con tecnología de guías de apoyo para el apoyo óptimo en el mecanizado de un paso de husillo de una máquina de mesa redonda con una longitud superior a 1000 mm
- 3 Herramienta combinada con insertos de corte y broca fabricada por completo en metal duro insertada para la fijación del soporte del freno y el mecanizado en varias etapas de un soporte de rueda de GJS
- 4 La construcción tangencial permite el avellanado completo del contorno de la forma del agujero de rotor de turbina en el turbocompresor de materiales muy resistentes al calor con lubricación minimizada
- 5 Herramienta especial para el mecanizado de cojinetes giratorios para el semimecanizado y mecanizado de desbaste, incl. roturas de cantos y fresado de ranuras y broca insertada adicional
- 6 Herramienta combinada de construcción ultraligera con partes del cuerpo básico de CFK, insertos de corte tangenciales y radiales para mecanizar el tren principal en la caja de cambios de aluminio
- 7 Herramienta combinada para el mecanizado en varias etapas de un engranaje para cargas pesadas de GJL



Los amortiguadores de vibración mejoran considerablemente la calidad de la superficie en el mecanizado. El diseño se adapta individualmente a las respectivas tareas de mecanizado.

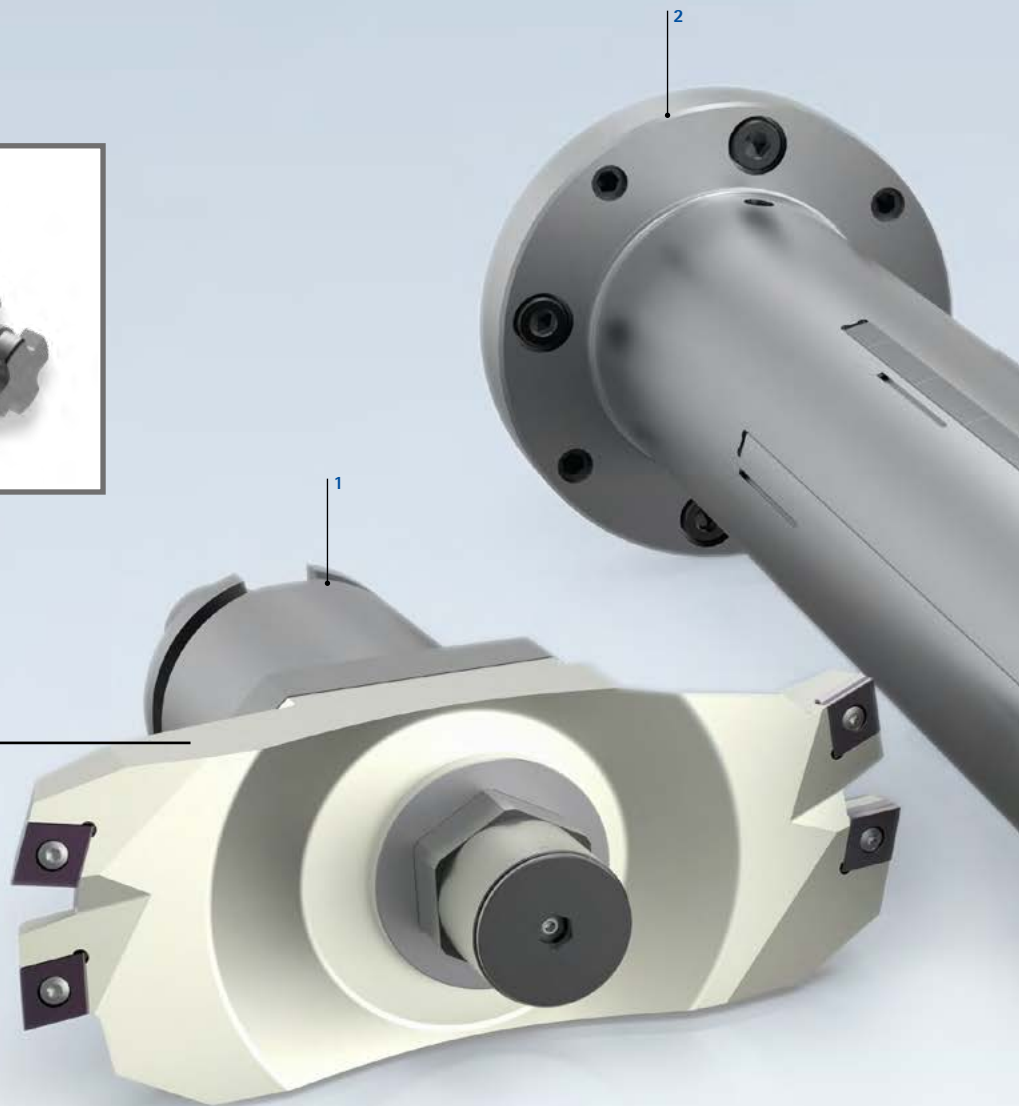



SOLUCIONES ESPECIALES

Mandrinado con insertos de corte (2/2)

Ejemplos de aplicación de las soluciones especiales con insertos de corte

- 1 Herramienta de torneado de interpolación con placas de molde y trayectoria de corte continua para el mecanizado de la conexión de la banda en V del contorno de ranura de una carcasa de turbina (turbocompresor).
- 2 Mecanizado de preacabado y semiacabado del agujero principal de la carcasa de la turbina (turbocompresor). Con una sola herramienta se producen seis características de mecanizado y un corte de control.
- 3 Herramienta combinada con insertos de corte tangenciales y guías de apoyo de cermet y PKD.
- 4 Mecanizado de acabado de carcasas de turbinas y compresores con la herramienta de accionamiento mecatrónico TOOLTRONIC®.
- 5 Mecanizado del agujero principal con herramienta combinada ISO que combina los pasos de mecanizado de ranurado, taladrado de precisión y avellanado.





SOLUCIONES ESPECIALES

Placas de corte con ejecución especial

Para mecanizar eficazmente contornos complejos con una alta precisión de forma, se utilizan con frecuencia filos perfilados.

MAPAL ofrece para estos insertos todas las posibilidades en cuanto a forma, material de corte y recubrimiento. Los modernos equipos de fabricación garantizan la máxima precisión y flexibilidad de las placas de corte con ejecución especial MAPAL.

También las placas de corte equipadas con PCD y PcBN están disponibles en esta variedad. Integrándolas en los asientos de los insertos de alta precisión de las herramientas MAPAL, se logran los mejores resultados tanto económicos como cualitativos.



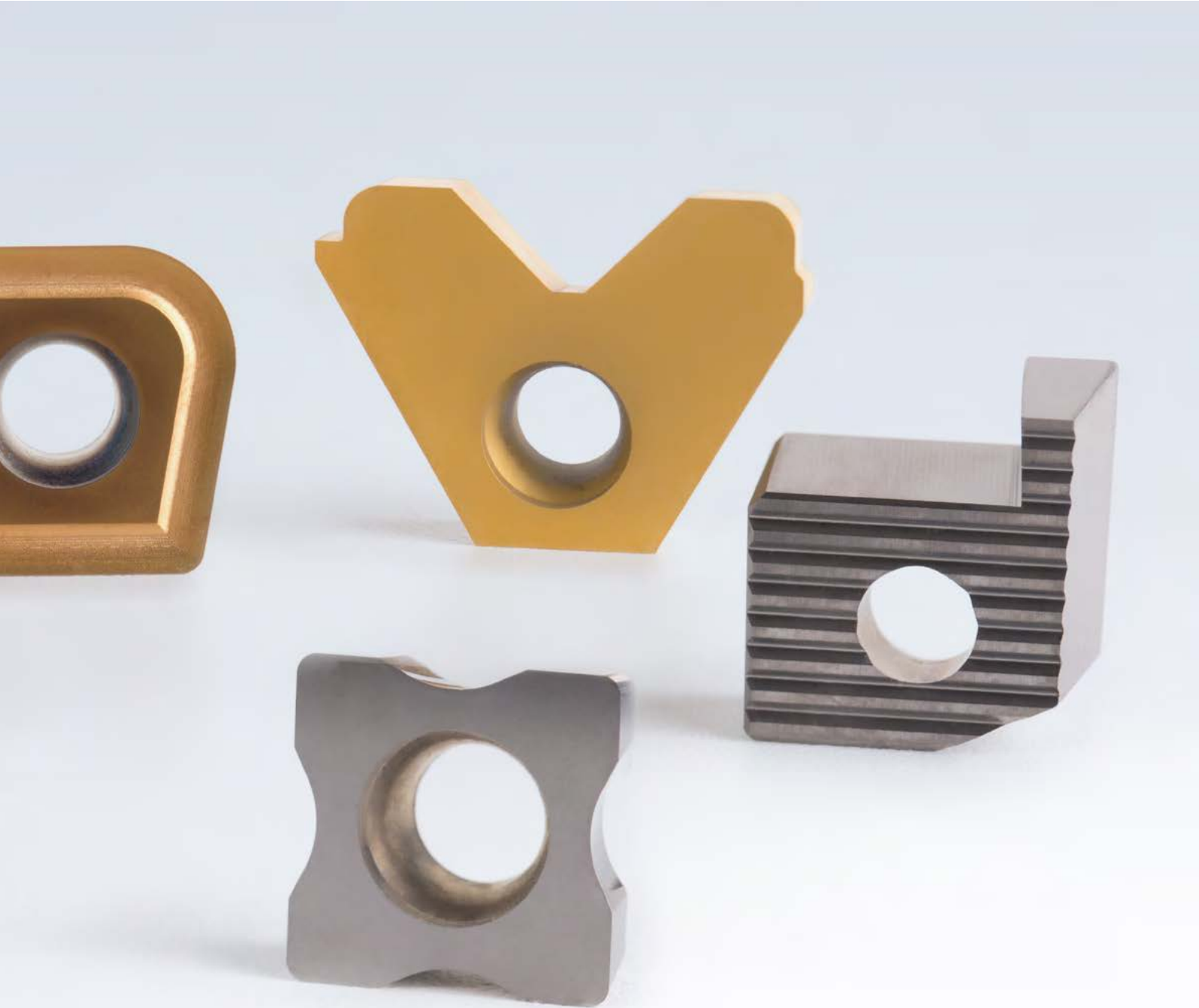

VENTAJAS

- Alta seguridad del proceso en formas y geometrías dependientes del contorno
- Ahorro de complejas secuencias de mecanizado
- Aprovechamiento de todos los filos en la fabricación de contornos complejos





ModulBore

Alta flexibilidad en el mandrinado y el taladrado de precisión

Con el programa de mandrinado ModulBore, MAPAL ofrece un sistema completo para los mecanizados previo y de acabado de agujeros con un rango de diámetro de 6 a 1000 mm.

El sistema es muy flexible por su estructura modular y puede configurarse para la tarea de mecanizado correspondiente. Para el mecanizado de desbaste hay disponibles herramientas de mandrinado de doble filo. Gracias a un dentado frontal en el que se alojan los soportes de insertos, las herramientas son muy estables y eficaces. El uso de insertos de corte con geometría básica positiva, los espacios para virutas en espiral y el suministro de refrigerante interior garantizan un campo de aplicación amplio, una alta seguridad de trabajo y un fácil manejo.

Los cabezales de taladrado de precisión ya están disponibles a partir de un diámetro de 6 mm. Estos se caracterizan por su alta precisión y estructura robusta, son fáciles de manipular y disponen de un suministro de refrigerante interior. El ajuste de precisión de los cabezales se realiza con gran exactitud en ambas direcciones de ajuste sin «efecto stick-slip» (efecto de adherencia y deslizamiento).

El programa ModulBore se adapta individualmente a las necesidades específicas del cliente y, por tanto, no está disponible en almacén.

ModulBore

Introducción	614
Vista general del sistema	618
ModulBore – Mandrinado	620
ModulBore – Taladrado de precisión	627
Adaptadores	636

ModulBore – Mandrinado

Ø 22 – 115 mm

Fresas de doble filo con sistema ModulBore (MBS) en siete dimensiones para soporte de placas de corte (cartuchos para inserto de corte).

Ø 87 – 202 mm

Cabezales de mandrinado como construcción tipo puente. Distribución en cinco puentes para soporte de placas de corte (cartuchos para inserto de corte).

Ø 200 – 520 mm

Cabezales de mandrinado como construcción tipo puente. Distribución en cuatro puentes para equipamiento con carro para soportes de sujeción cortos ISO convencionales.

Ø 358 – 1000 mm

Cabezales de mandrinado como construcción tipo puente (área de mandrinado grande). Distribución en ocho puentes para equipamiento con carro para soportes de sujeción cortos ISO convencionales.



* Cantidad de pedido necesaria: 2 unidades

Herramientas de mandrinado



Fresas de doble filo con MBS

Para el mecanizado de desbaste en el rango de diámetros de 22 a 115 mm hay disponibles herramientas de mandrinado de doble filo. Gracias a un dentado frontal en el que se alojan los soportes de placas de corte, el sistema es muy estable y eficaz. El uso de insertos de corte con geometría básica positiva, los espacios para virutas en espiral y el suministro de refrigerante interior garantizan un campo de aplicación amplio, una alta seguridad de trabajo y un fácil manejo.

Las fresas de doble filo están disponibles como herramienta modular o monobloque, con unión HSK o SK.

* Cantidad de pedido necesaria: 2 unidades



Cabezales de mandrinado con módulo puente y cartucho ISO

Los cabezales de mandrinado con módulo de puente están disponibles en el rango de 87 a 1000 mm.

A partir de un diámetro de 200 mm, los módulos de puente están equipados con soportes de sujeción cortos ISO, que son guiados sobre unos carros con dentado, por la parte frontal, sobre los puentes. Para optimizar el peso, los módulos de puente en el rango de diámetros de 358 a 1000 mm se fabrican en aluminio.

ModulBore – Taladrado de precisión

Ø 10 – 28 mm

Cabezales de taladrado de precisión con barra de mandrinar

Ø 14 – 23 mm

Barra de mandrinado de precisión

Ø 21 – 115 mm

Cabezal de taladrado de precisión con MBS

Ø 87 – 202 mm

Cabezales de taladrado de precisión como construcción tipo puente. Distribución en cuatro puentes para equipamiento con carro para soportes de sujeción cortos para cabezal de taladrado de precisión ModulBore.

Ø 200 – 520 mm

Cabezales de taladrado de precisión como construcción tipo puente. Distribución en cuatro puentes para equipamiento con carro para soportes de sujeción cortos para cabezal de taladrado de precisión ModulBore.

Ø 358 – 1000 mm

Cabezales de taladrado de precisión como construcción tipo puente (área de mandrinado grande). Distribución en ocho puentes para equipamiento con carro para soportes de sujeción corto para cabezal de taladrado de precisión ModulBore.



Herramientas de taladrado de precisión



Cabezal de taladrado de precisión con barra de mandrinar

El programa incluye cabezales de taladrado de precisión ModulBore a partir de un diámetro de 6 mm. Estos se caracterizan por una alta precisión y estructura robusta, son fáciles de manipular y disponen de un suministro de refrigerante interior. El ajuste de precisión de los cabezales se realiza con gran exactitud en ambas direcciones de ajuste sin «efecto stick-slip» (efecto de adherencia y deslizamiento).

Los cabezales de taladrado de precisión están disponibles como herramienta modular o monobloque, con unión HSK o SK.



Cabezales de taladrado de precisión con módulo puente y cartucho de taladrado de precisión

A partir de un diámetro de 87 mm, los cabezales de taladrado de precisión tienen un módulo de puente. En los módulos puente hay carros que están equipados con cartuchos de taladrado de precisión ajustables. Para diámetros mayores, las herramientas de puente tendrán un filo. El carro opuesto se utiliza para la compensación de desbalanceo. Para optimizar el peso, los módulos de puente en el rango de diámetros de 358 a 1000 mm se fabrican en aluminio.

ModulBore-Plus – Taladrado de precisión

Las herramientas ModulBore-Plus con ajuste de precisión se caracterizan por un mecanismo de ajuste fácil y preciso. Este permite una aproximación definida, sin errores, directamente en la máquina, por medio de una llave TORX® estándar. La gran precisión y fácil manipulación reducen los tiempos no productivos durante el taladrado de precisión, y aumentan la calidad y productividad.

MODULBORE-PLUS

- **Ajuste de precisión:**
2 μm por graduación referido al diámetro
- **Error de inversión:**
<2 μm

VENTAJAS

- Legible sin errores (no requiere nonio)
- Sin «efecto stick-slip» (efecto de adherencia y deslizamiento)
- Mantenimiento reducido
- Fácil de montar
- Gran duración y robustez: tres años de garantía

Barra de mandrinado de precisión

La barra de mandrinado de precisión ModulBore-Plus es ideal para el uso en la fabricación en serie y a gran escala, y ofrece una vida útil máxima.

Cabezal de taladrado de precisión

El fiable cabezal de taladrado de precisión ModulBore-Plus es ideal para el taladrado de precisión, desde la fabricación de prototipos hasta la fabricación a gran escala. La unidad de ajuste aproximado adicional proporciona al cabezal de taladrado un radio de acción variable de hasta 9 mm. El programa completo permite el mecanizado de agujeros con diámetros de 21 a 115 mm.

Soportes de sujeción cortos para cabezal de taladrado de precisión

Los soportes de sujeción cortos para cabezal de taladrado de precisión ModulBore-Plus están diseñados para el uso en herramientas especiales de uno o varios filos, o en puentes de taladrado de precisión para el rango de taladrado grande. No requieren ninguna adaptación del husillo de la máquina.

Sistemas de herramientas ModulBore-Plus

Barra de mandrinado de precisión \varnothing 14 – 23 mm



Cabezal de taladrado de precisión \varnothing 21 – 115 mm



Soportes de sujeción cortos para cabezal de taladrado de precisión



Adaptadores ModulBore

Unión MBS

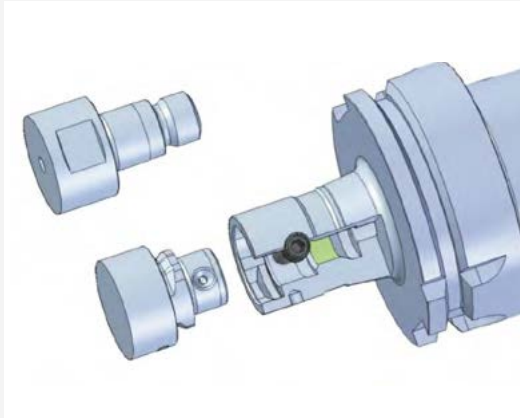

La unión MBS es la característica central del sistema ModulBore. Mediante el acoplamiento de bayoneta, que permite un contacto de apoyo plano del cilindro, se transmiten unas fuerzas de par de giro elevadas. Dos tornillos de sujeción radiales permiten la tensión previa del acoplamiento y la rotación de la herramienta en ambas direcciones.

VENTAJAS

- Fácil manejo, montaje y desmontaje sin problemas
- Acoplamiento de bayoneta de alta precisión con orientación de los filos
- Alta precisión de concentricidad mediante el asiento sobre planos
- Suministro de refrigerante interior a través de la unión hacia el inserto
- Compatible con Starflex RFX

Adaptador MBS



Los adaptadores MBS ofrecen la posibilidad de adaptar la conexión de la máquina a la conexión MBS. De este modo puede utilizarse ilimitadamente el amplio programa ModuleBore. En el programa estándar se incluyen las conexiones convencionales como conexiones HSK, diversos conos de gran inclinación (SK/BT) en muchos tamaños y longitudes nominales. Las alargaderas y los reductores del sistema MBS aumentan, además, la flexibilidad del sistema. Pueden fabricarse otros adaptadores como herramientas especiales.

Mandriles



Los portafresas/mandriles de ranura transversal combinados son la base de múltiples variaciones de las herramientas de puente ModulBore. En el programa estándar se incluyen las conexiones convencionales como conexiones HSK, diversos conos de gran inclinación (SK/BT) en muchos tamaños y longitudes nominales. Además, otras conexiones de máquinas como KM según DIN ISO 26622 pueden equiparse como portafresas combinado utilizando las herramientas de puente.

ModulBore – Visión general del sistema

ModulBore | Adaptadores

Adaptador MBS
Página 636 – 638

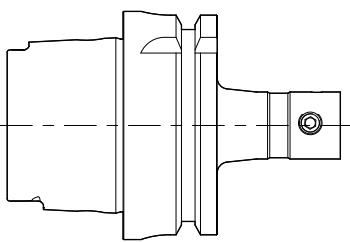
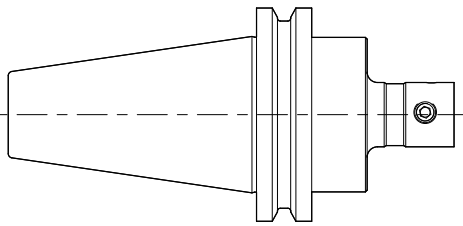
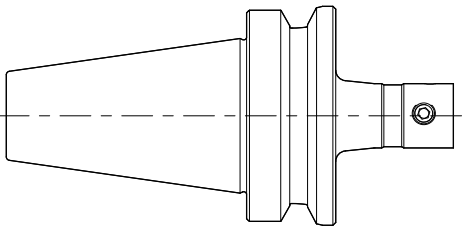

Alargaderas MBS
Página 639

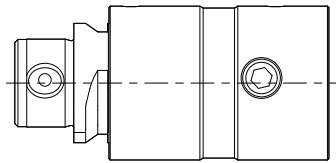

Reductores MBS
Página 640

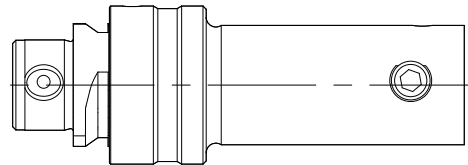

Mandriles de ranura transversal MBS
Página 641

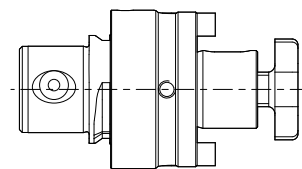

Mandriles
véase el catálogo «SUJECIÓN»

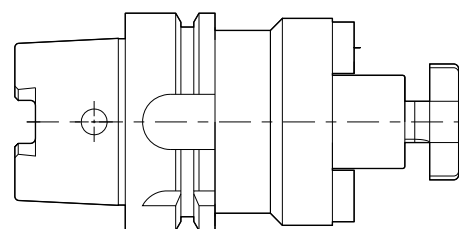

► Unión MBS

► Mandril

ModulBore | Mandrinado

Fresas de doble filo con MBS

Página 620

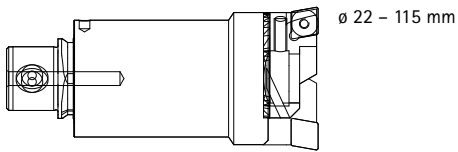

¡También disponible como herramienta monobloque!

Cabezal de mandrinado con módulo de puente

Página 622

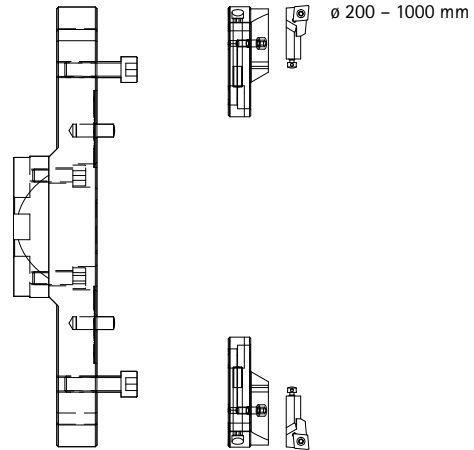
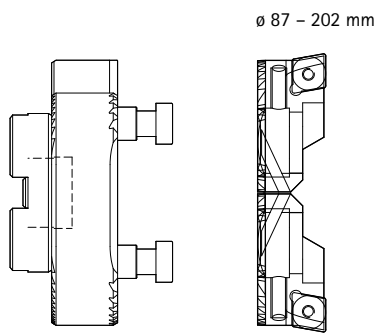

ModulBore | Taladrado de precisión

ModulBore – Cabezal de taladrado de precisión con MBS

Página 627

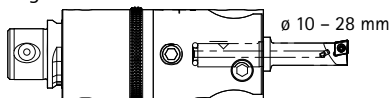

¡También disponible como herramienta monobloque con interfaz HSK/SK!

ModulBore-Plus – Cabezal de taladrado de precisión con MBS

Página 630

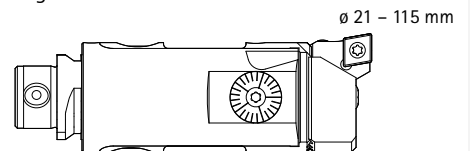

ModulBore – Cabezal de taladrado de precisión con módulo de puente

Página 631

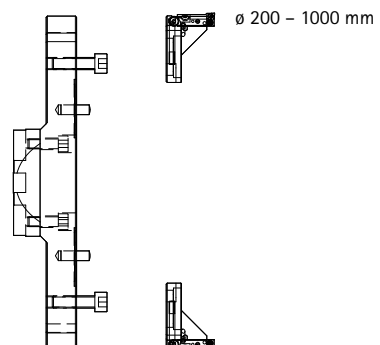
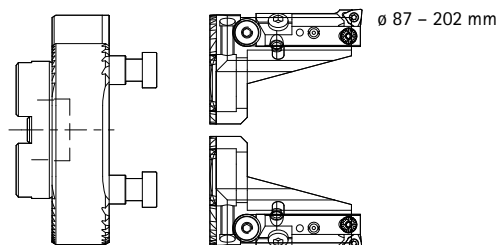

ModulBore – Fresas de doble filo con MBS

Herramienta de mandrinado para el mecanizado de desbaste, cuerpo sin cartuchos para inserto de corte
 \varnothing 22 – 115 mm

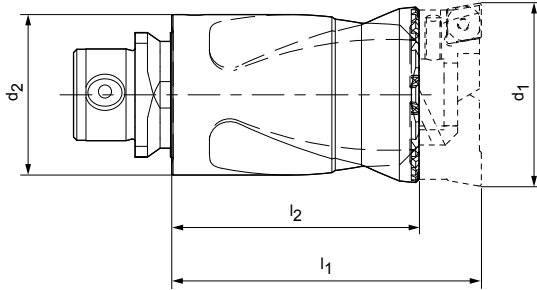

d_1 mín. – máx.	d_2 Tamaño MBS	l_1	l_2	Ancho de llave	Especificación	Referencia
22 - 30	18,5	40	27,7	17	MBO100-022030-Z2-MBS185	30415217
30 - 39	24,5	50	37,7	22	MBO100-030039-Z2-MBS254	30415218
39 - 50	32	65	48,7	27	MBO100-039050-Z2-MBS320	30415219
50 - 67	42	90	68,2	36	MBO100-050067-Z2-MBS420	30415220
67 - 88	55	115	90,7	46	MBO100-067088-Z2-MBS550	30415221
88 - 115	72	150	113,7	60	MBO100-088115-Z2-MBS720	30415222

Plazo de entrega a petición.

Ejemplo

Visión general del sistema – Fresas de doble filo con MBS

\varnothing 22 – 115 mm

Adaptador MBS

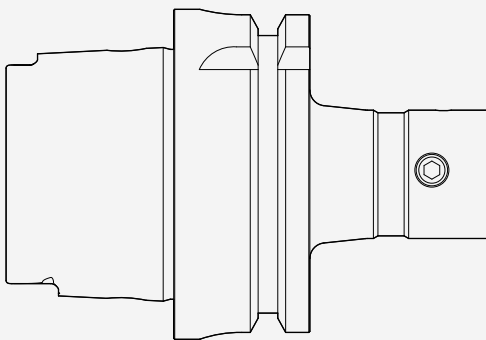

Fresas de doble filo con MBS

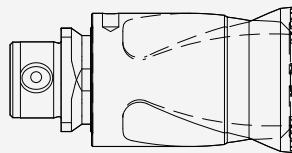

Cartuchos para inserto de corte (portaplaquitas)



ModulBore – Cartuchos para inserto de corte para fresa de doble filo

Ø 22 – 115 mm

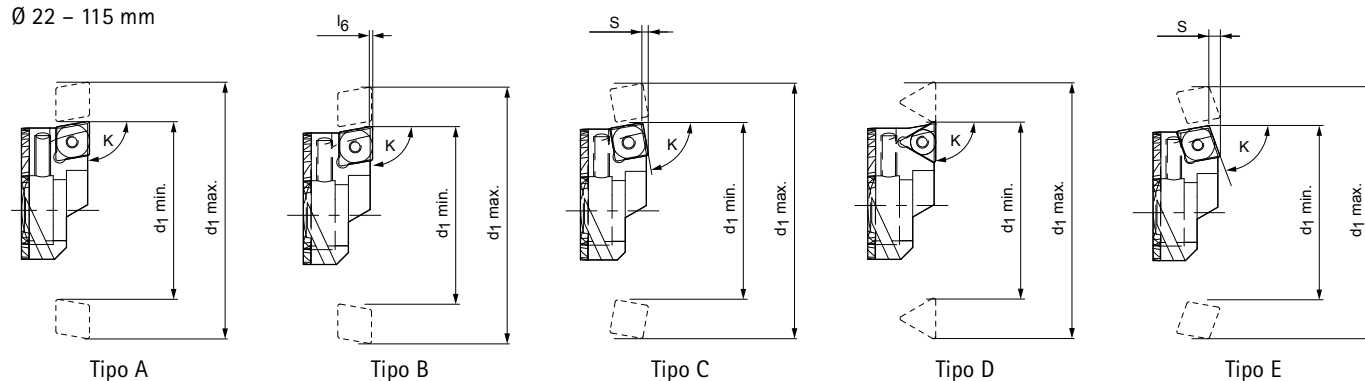

d_1 mín. – máx.	Tipo	K	Desplazamiento de altura l_6	S	Inserto de corte	Especificación	Referencia
22 - 30	A	90°			CC/CP.. 0602	IC-MBO100-022030-A90-C_06	30415185
	B	90°	0,3		CC/CP.. 0602	IC-MBO100-022030-B90-C_06	30415186
	E	70°		2	CC/CP.. 0602	IC-MBO100-022030-E70-C_06	30415187
30 - 39	A	90°			CC/CP.. 0602	IC-MBO100-030039-A90-C_06	30415188
	B	90°	0,3		CC/CP.. 0602	IC-MBO100-030039-B90-C_06	30415189
	C	80°		2	SP.. 0703	IC-MBO100-030039-C80-S_07	30415190
	E	70°		2	CC/CP.. 0602	IC-MBO100-030039-E70-C_06	30415191
39 - 50	A	90°			CC/CP.. 09T3	IC-MBO100-039050-A90-C_09	30415192
	B	90°	0,3		CC/CP.. 09T3	IC-MBO100-039050-B90-C_09	30415193
	C	80°		1,5	SC/SP.. 09T3	IC-MBO100-039050-C80-S_09	30415194
	D	90°			TC/TP.. 09T3	IC-MBO100-039050-D90-T_09	30415195
	E	70°		3,1	CC/CP.. 09T3	IC-MBO100-039050-E70-C_09	30415196
50 - 67	A	90°			CC/CP.. 1204	IC-MBO100-050067-A90-C_12	30415197
	B	90°	0,3		CC/CP.. 1204	IC-MBO100-050067-B90-C_12	30415198
	C	80°		2,1	SC/SP.. 09T3	IC-MBO100-050067-C80-S_09	30415199
	D	90°			TC/TP.. 09T3	IC-MBO100-050067-D90-T_09	30415200
	E	70°		4,1	CC/CP.. 1204	IC-MBO100-050067-E70-C_12	30415201
67 - 88	A	90°			CC/CP.. 1204	IC-MBO100-067088-A90-C_12	30415202
	B	90°	0,3		CC/CP.. 1204	IC-MBO100-067088-B90-C_12	30415203
	C	80°		2,1	SC/SP.. 1204	IC-MBO100-067088-C80-S_12	30415204
	D	90°			TNM.. 16T3	IC-MBO100-067088-D90-T_16	30415205
	E	70°		4,1	CC/CP.. 1204	IC-MBO100-067088-E70-C_12	30415206
88 - 115	A	90°			CC/CP.. 1204	IC-MBO100-088115-A90-C_12	30415207
	B	90°	0,3		CC/CP.. 1204	IC-MBO100-088115-B90-C_12	30415208
	C	80°		2,5	SC/SP.. 1204	IC-MBO100-088115-C80-S_12	30415209
	D	90°			TNM.. 2204	IC-MBO100-088115-D90-T_22	30415210
	E	70°		4,1	CC/CP.. 1204	IC-MBO100-088115-E70-C_12	30415211

Cantidad de pedido necesaria: 2 unidades

Plazo de entrega a petición.

ModulBore – Cabezal de mandrinado con módulo de puente

Herramienta de mandrinado para el mecanizado de desbaste, cuerpo de herramienta sin cartucho para inserto de corte
 \varnothing 87 – 202 mm

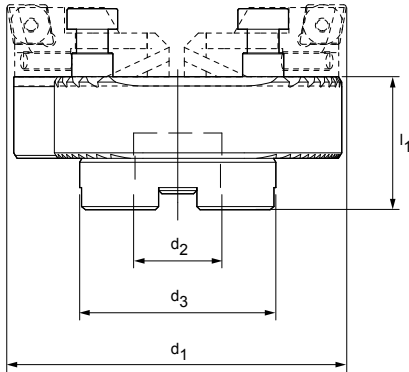

d_1 mín. – máx.	d_2	d_3	l_1	Especificación	Referencia
87 - 110	27	61,5	42	MBO110-087110-Z2-CA27	30415224
109 - 133	27	61,5	42	MBO110-109133-Z2-CA27	30415225
132 - 156	27	62	42	MBO110-132156-Z2-CA27	30415226
155 - 179	27	62	42	MBO110-155179-Z2-CA27	30415227
178 - 202	27	62	42	MBO110-178202-Z2-CA27	30415228

Plazo de entrega a petición.

Ejemplo

Visión general del sistema – Cabezal de mandrinado con módulo de puente

\varnothing 87 – 202 mm

Adaptador MBS

Módulo de puente

Cartuchos para inserto de corte
(portaplaquitas)

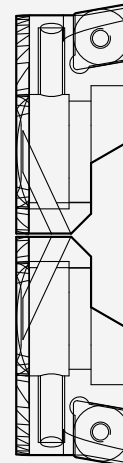
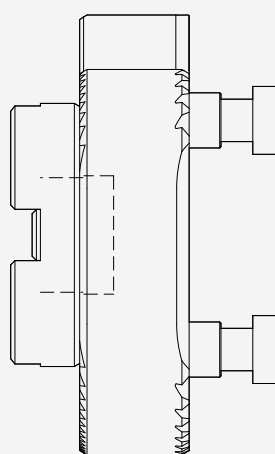
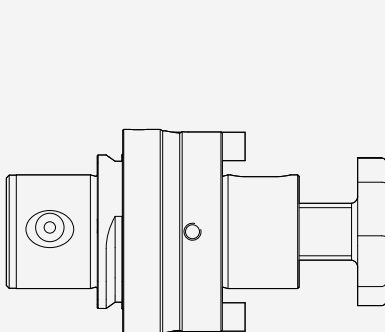

ModulBore – Cartuchos para inserto de corte para fresa de doble filo

Ø 87 – 202 mm

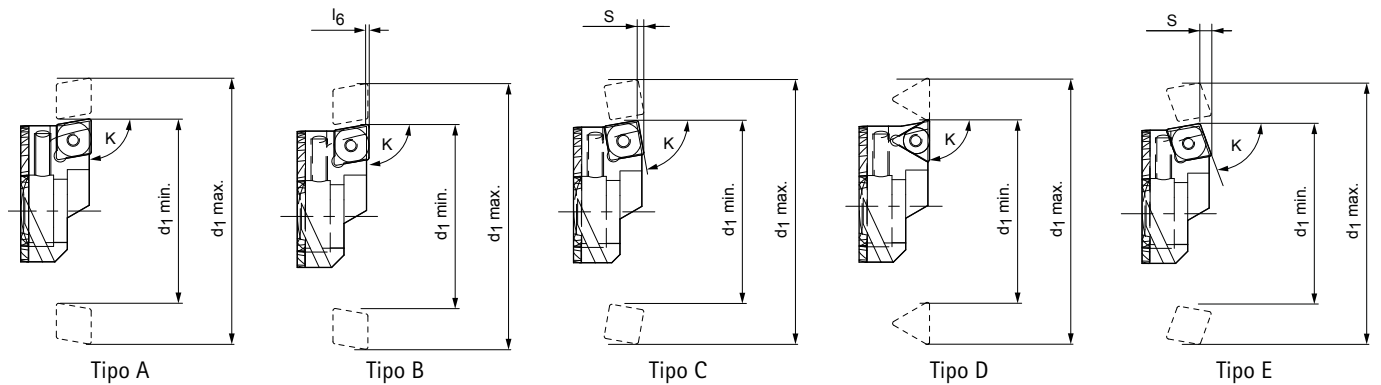

d_1 mín. – máx.	Tipo	K	Desplazamiento de altura l_6	S	Inserto de corte	Especificación	Referencia
87 - 202	A	90°			CC/CP.. 1204	IC-MBO100-067088-A90-C_12	30415202
	B	90°	0,3		CC/CP.. 1204	IC-MBO100-067088-B90-C_12	30415203
	C	80°		2,1	SC/SP.. 1204	IC-MBO100-067088-C80-S_12	30415204
	D	90°			TNM.. 16T3	IC-MBO100-067088-D90-T_16	30415205
	E	70°			4,1	CC/CP.. 1204	IC-MBO100-067088-E70-C_12

Cantidad de pedido necesaria: 2 unidades

Plazo de entrega a petición.

ModulBore – Cabezal de mandrinado con módulo de puente

Herramienta de mandrinado para el mecanizado de desbaste, sin carro ni soporte de sujeción corto

Ø 200 – 520 mm

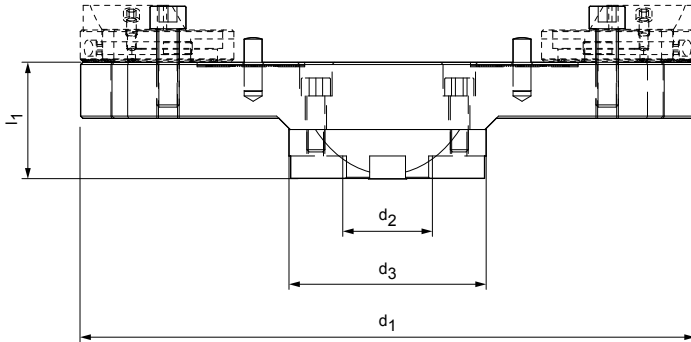

d_1 mín. - máx.	d_2	d_3	l_1	Especificación	Referencia
200 - 280	40	88	51	MB0120-200280-Z2-CA40	30415229
280 - 360	40	88	51	MB0120-280360-Z2-CA40	30415230
360 - 440	40	88	61	MB0120-360440-Z2-CA40	30415231
440 - 520	40	88	61	MB0120-440520-Z2-CA40	30415232

Plazo de entrega a petición.

ModulBore – Cabezal de mandrinado con módulo de puente

Herramienta de mandrinado para el mecanizado de desbaste, ejecución reforzada de aluminio, sin carro ni soporte de sujeción corto

Ø 358 – 1000 mm

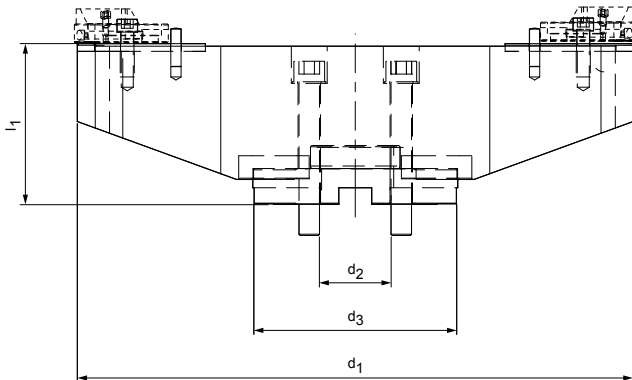

d_1 mín. - máx.	d_2	d_3	l_1	Especificación	Referencia
358 - 440	60	130	91	MB0130-358440-Z2-CA60	30415233
438 - 520	60	130	126	MB0130-438520-Z2-CA60	30415234
518 - 600	60	130	126	MB0130-518600-Z2-CA60	30415235
598 - 680	60	130	126	MB0130-598680-Z2-CA60	30415236
678 - 760	60	130	126	MB0130-678760-Z2-CA60	30415237
758 - 840	60	130	126	MB0130-758840-Z2-CA60	30415238
838 - 920	60	130	126	MB0130-838920-Z2-CA60	30415239
918 - 1000	60	130	126	MB0130-918000-Z2-CA60	30415240

Plazo de entrega a petición.

Medidas en mm.

ModulBore – Carro para soporte de sujeción corto ISO

Ø 200 – 1000 mm

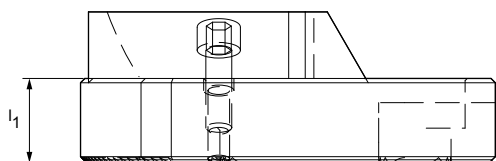

Para ø de herramienta d_1	l_1	Especificación	Referencia
200 – 1.000	19,4	SL-MBO140-2001000	30415309

Plazo de entrega a petición.

ModulBore – Soporte de sujeción corto ISO

Ø 200 – 1000 mm

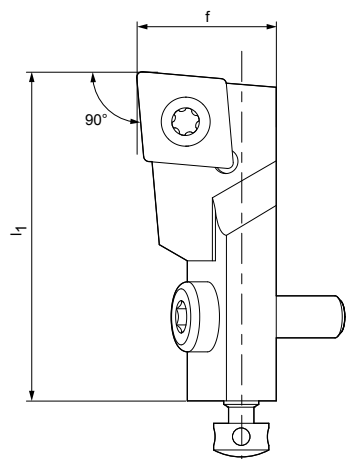

Tipo A

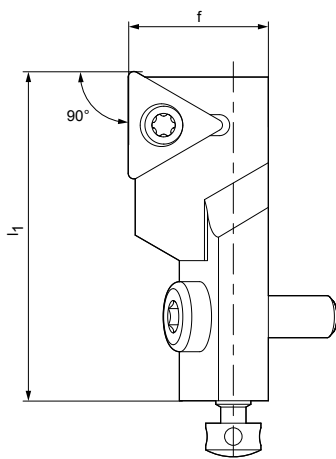

Tipo B

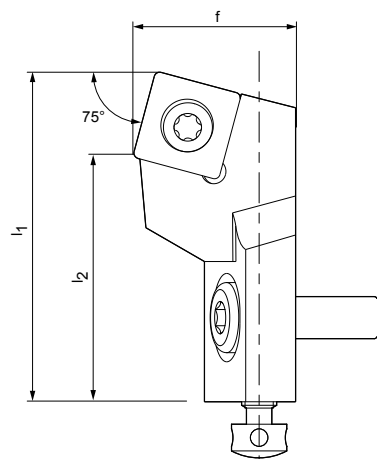

Tipo C

Tipo	f	l_1	l_2	Insertos de corte	Especificación	Referencia
A	20	47	-	CC...1204	SCLCL12CA-12	30011071
B	20	47	-	TC16T3	STGCL12CA-16	30011077
C	20	47	35,409	SC...1204	SSRCL12CA-12	30011103

Plazo de entrega a petición.

Accesorios, véase página 660.

Medidas en mm.

Ejemplo

Visión general del sistema – Cabezal de mandrinado con módulo de puente

Ø 200 – 1000 mm

Adaptadores

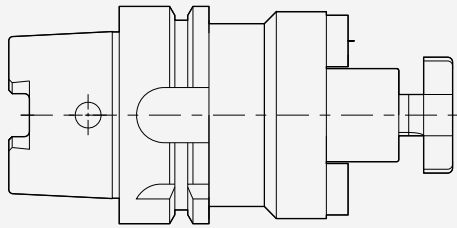

Módulo de puente

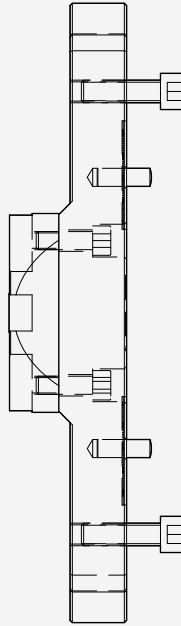

Carro + soporte de sujeción corto ISO

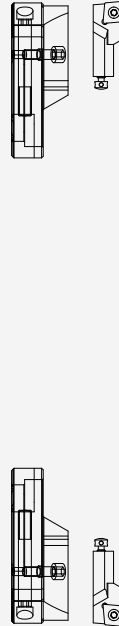

ModulBore – Cabezal de taladrado de precisión

Herramienta de mandrinado para el mecanizado de precisión, cuerpo de herramienta sin barra de mandrinar
 \varnothing 10 – 28 mm

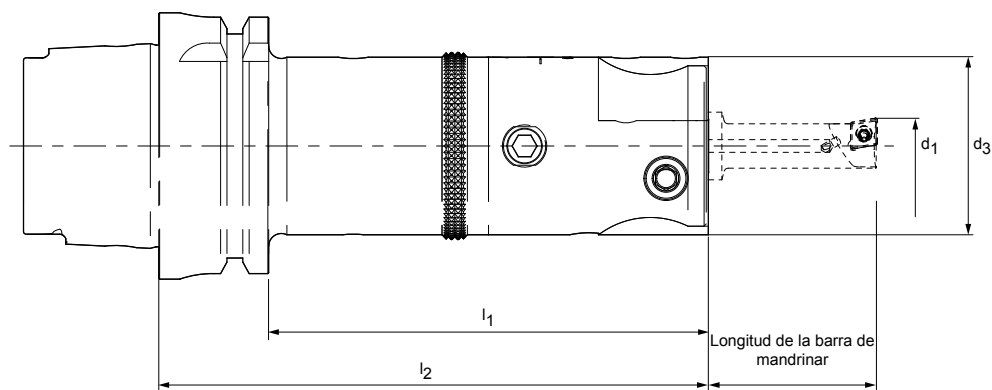

d_1 mín. – máx.	Mango	d_3	l_1	l_2	Especificación	Referencia
10 - 28	MBS	42		95	MBO201-006028-Z1-MBS420	30415248
	MAS BT40	42	76	103	MBO201-006028-Z1-BT040	30415241
	SK40	42	84	103	MBO201-006028-Z1-SK040	30415249
	HSK-A40	42	110	130	MBO201-006028-Z1-HSK-A040	30415242
	HSK-A50	42	104	130	MBO201-006028-Z1-HSK-A050	30415243
	HSK-A63	42	104	130	MBO201-006028-Z1-HSK-A063	30415244
	HSK-A80	42	104	130	MBO201-006028-Z1-HSK-A080	30415245
	HSK-A100	42	101	130	MBO201-006028-Z1-HSK-A100	30415246
	KM40	42		100	MBO201-006028-Z1-KM40	30415247

Regulación aproximada $d_1 = 3$ mm | Rango de regulación fina $d_1 = 0,4$ mm

Plazo de entrega a petición.

Ejemplo

Visión general del sistema MBS – Cabezal de taladrado de precisión

\varnothing 10 – 28 mm

Adaptadores

Cabezal de taladrado de precisión con MBS

Barra de mandrinar

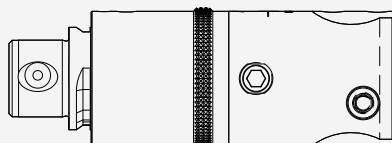
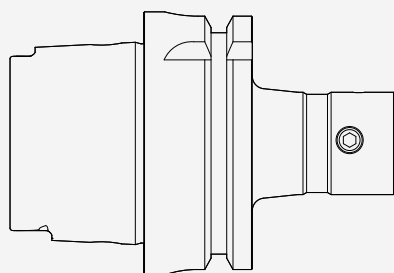

ModulBore – Barras de mandrinar para cabezal de taladrado de precisión

Barra de mandrinar para cabezal de taladrado de precisión, con suministro de refrigerante interior

Ø 10 – 28 mm

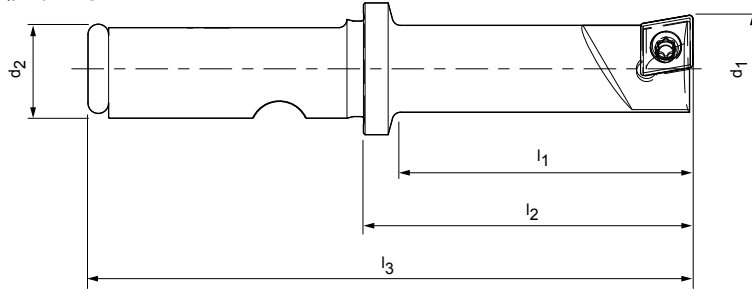

d_1 mín. – máx.	d_2	l_1	l_2	l_3	Inserto de corte	Especificación	Referencia
10 - 13	12	30	35	70	CC.. 0602	MB0211-010013-Z1-22	30415260
13 - 16	12	35	40	75	CC.. 0602	MB0211-013016-Z1-22	30415261
16 - 19	12	40	45	80	CC.. 0602	MB0211-016019-Z1-22	30415262
19 - 22	12	50	55	90	CC.. 0602	MB0211-019022-Z1-22	30415263
22 - 25	12	60	65	100	CC.. 0602	MB0211-022025-Z1-22	30415264
25 - 28	12	70	75	110	CC.. 0602	MB0211-025028-Z1-22	30415265

Plazo de entrega a petición.

ModulBore-Plus – Barra de mandrinado de precisión

Herramienta de mandrinado de acabado para el mecanizado de precisión, con suministro de refrigerante interior

Ø 14 – 23 mm

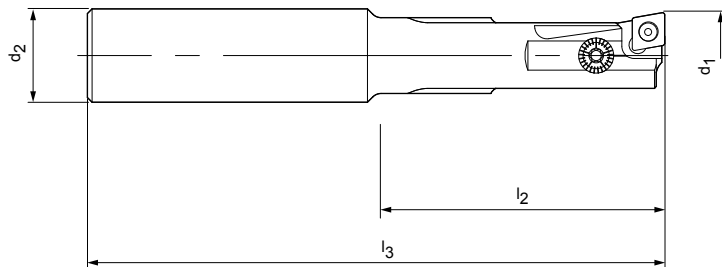

d ₁	d ₂	l ₂	l ₃	Inserto de corte	Especificación	Referencia
14,0	16	48	99	CC.. 0602	MB0311-0140-Z1-WC16	30415266
14,5	16	48	99	CC.. 0602	MB0311-0145-Z1-WC16	30415267
15,0	16	48	99	CC.. 0602	MB0311-0150-Z1-WC16	30415268
15,5	16	48	99	CC.. 0602	MB0311-0155-Z1-WC16	30415269
16,0	20	54	107	CC.. 0602	MB0311-0160-Z1-WC20	30415270
16,5	20	54	107	CC.. 0602	MB0311-0165-Z1-WC20	30415271
17,0	20	54	107	CC.. 0602	MB0311-0170-Z1-WC20	30415272
17,5	20	54	107	CC.. 0602	MB0311-0175-Z1-WC20	30415273
18,0	20	60	113	CC.. 0602	MB0311-0180-Z1-WC20	30415274
18,5	20	60	113	CC.. 0602	MB0311-0185-Z1-WC20	30415275
19,0	20	60	113	CC.. 0602	MB0311-0190-Z1-WC20	30415276
19,5	20	60	113	CC.. 0602	MB0311-0195-Z1-WC20	30415277
20,0	20	70	125	CC.. 0602	MB0311-0200-Z1-WC20	30415278
20,5	20	70	125	CC.. 0602	MB0311-0205-Z1-WC20	30415279
21,0	20	70	125	CC.. 0602	MB0311-0210-Z1-WC20	30415280
21,5	20	70	125	CC.. 0602	MB0311-0215-Z1-WC20	30415281
22,0	20	70	125	CC.. 0602	MB0311-0220-Z1-WC20	30415282
22,5	20	70	125	CC.. 0602	MB0311-0225-Z1-WC20	30415284
23,0	20	70	125	CC.. 0602	MB0311-0230-Z1-WC20	30415283

Rango de regulación diámetro nominal d₁ $\begin{matrix} +0,3 \text{ mm} \\ -0,1 \text{ mm} \end{matrix}$

Plazo de entrega a petición.

ModulBore-Plus – Cabezal de taladrado de precisión con MBS

Herramienta de mandrinado de acabado para el mecanizado de precisión, con suministro de refrigerante interior

Ø 21 – 115 mm

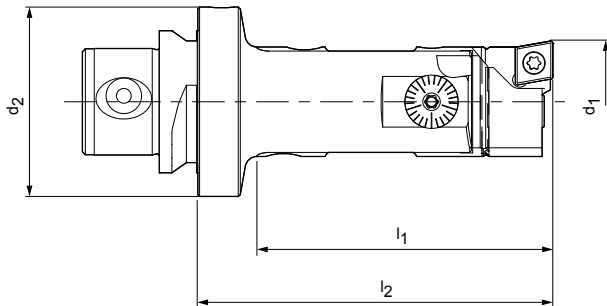

Disponibles a petición

d_1 mín. – máx.	d_2 Tamaño MBS	l_1	l_2	Inserto de corte	Especificación	Referencia
21 - 29	32	50	60	CC.. 0602	MBO401-021029-Z1-MBS320	30415285
29 - 39	24,5	65	65	CC.. 0602	MBO401-029039-Z1-MBS245	30415286
38 - 50	32	75	75	CC.. 0602	MBO401-038050-Z1-MBS320	30415287
50 - 65	42	95	95	CC.. 0602	MBO401-050065-Z1-MBS420	30415289
65 - 88	55	120	120	CC.. 0602	MBO401-065088-Z1-MBS550	30415291
88 - 115	72	150	150	CC.. 0602	MBO401-088115-Z1-MBS720	30415294

Regulación aproximada d_1 véase la tabla | Rango de regulación fina $d_1 = 0,4$ mm

Plazo de entrega a petición.

ModulBore – Cabezal de taladrado de precisión con módulo de puente

Herramienta de mandrinado de acabado para el mecanizado de precisión, sin carro ni soporte de sujeción corto para cabezal de taladrado de precisión $\varnothing 87 - 202$ mm

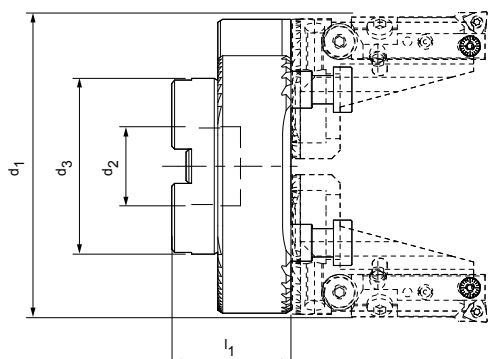

d_1 mín. - máx.	d_2	d_3	l_1	Especificación	Referencia
87 - 110	27	61,5	42	MB0110-087110-Z2-CA27	30415224
109 - 133	27	61,5	42	MB0110-109133-Z2-CA27	30415225
132 - 156	27	62	42	MB0110-132156-Z2-CA27	30415226
155 - 179	27	62	42	MB0110-155179-Z2-CA27	30415227
178 - 202	27	62	42	MB0110-178202-Z2-CA27	30415228

Plazo de entrega a petición.

ModulBore – Carro para soporte de sujeción corto para cabezal de taladrado de precisión

$\varnothing 87 - 202$ mm

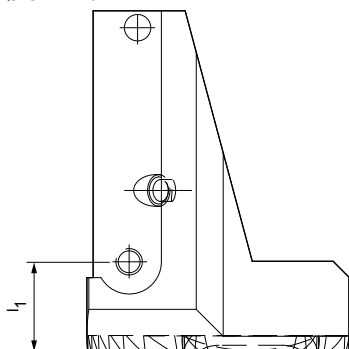

Para \varnothing de herramienta d_1	l_1	Especificación	Referencia
87 - 202	16,9	SL-MB0150-087202	30415310

Plazo de entrega a petición.

Ejemplo

Visión general del sistema – Cabezal de taladrado de precisión con módulo de puente $\varnothing 87 - 202 \text{ mm}$

Adaptadores

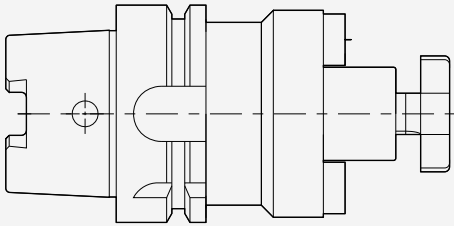

Módulo de puente

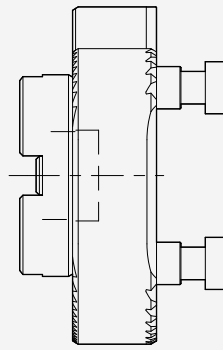

Carro + soporte de sujeción corto para cabezal de taladrado de precisión

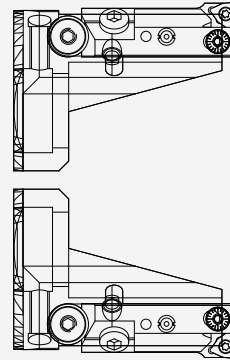

ModulBore – Cabezal de taladrado de precisión con módulo de puente

Herramienta de mandrinado de acabado para el mecanizado de precisión, sin carro ni soporte de sujeción corto para cabezal de taladrado de precisión Ø 200 – 520 mm

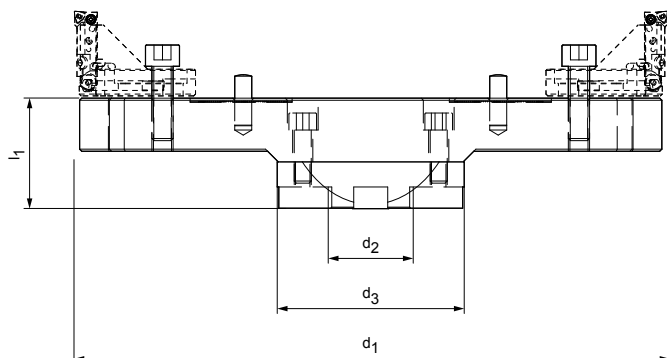

d_1 mín. - máx.	d_2	d_3	l_1	Especificación	Referencia
200 - 280	40	88	51	MB0120-200280-Z2-CA40	30415229
280 - 360	40	88	51	MB0120-280360-Z2-CA40	30415230
360 - 440	40	88	61	MB0120-360440-Z2-CA40	30415231
440 - 520	40	88	61	MB0120-440520-Z2-CA40	30415232

Plazo de entrega a petición.

ModulBore – Cabezal de taladrado de precisión con módulo de puente

Herramienta de mandrinado para el mecanizado de precisión, ejecución reforzada de aluminio, sin carro ni soporte de sujeción corto para cabezal de taladrado de precisión Ø 358 – 1000 mm

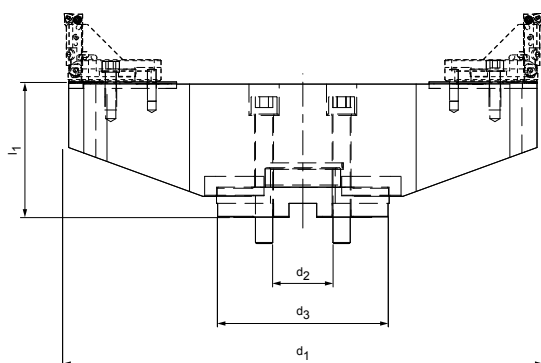

d_1 mín. - máx.	d_2	d_3	l_1	Especificación	Referencia
358 - 440	60	130	91	MB0130-358440-Z2-CA60	30415233
438 - 520	60	130	126	MB0130-438520-Z2-CA60	30415234
518 - 600	60	130	126	MB0130-518600-Z2-CA60	30415235
598 - 680	60	130	126	MB0130-598680-Z2-CA60	30415236
678 - 760	60	130	126	MB0130-678760-Z2-CA60	30415237
758 - 840	60	130	126	MB0130-758840-Z2-CA60	30415238
838 - 920	60	130	126	MB0130-838920-Z2-CA60	30415239
918 - 1.000	60	130	126	MB0130-918000-Z2-CA60	30415240

Plazo de entrega a petición.

Medidas en mm.

ModulBore – Carro para soporte de sujeción corto para cabezal de taladrado de precisión $\varnothing 200 - 1000$ mm

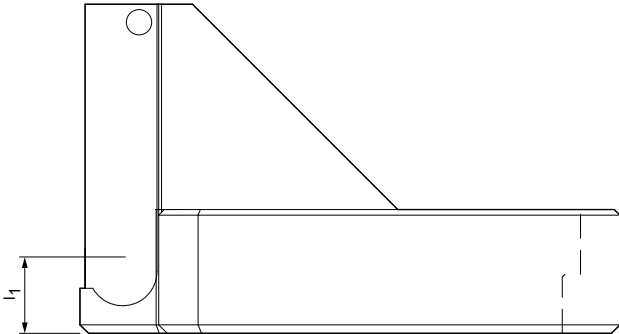

Para \varnothing de herramienta d_1	l_1	Especificación	Referencia
200 - 1.000	13,1	SL-MBO150-2001000	30415311

Contrapeso adecuado para el mecanizado de husillos con un filo referencia 30522418.
Plazo de entrega a petición.

Ejemplo

Visión general del sistema – Cabezal de taladrado de precisión con módulo de puente $\varnothing 200 - 1000$ mm

Adaptadores

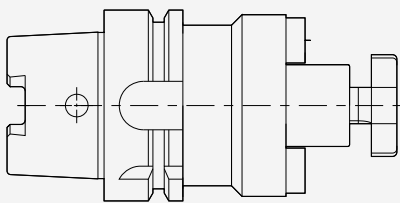

Módulo de puente

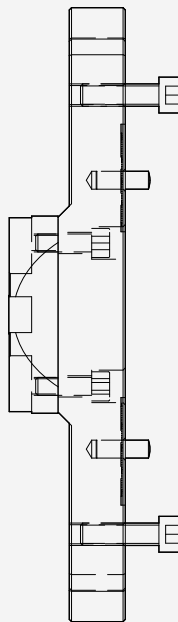

Carro + soporte de sujeción corto para cabezal de taladrado de precisión + contrapeso

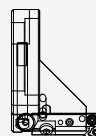
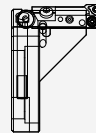

ModulBore – Soporte de sujeción corto para cabezal de taladrado de precisión $\varnothing 87 - 1000$ mm

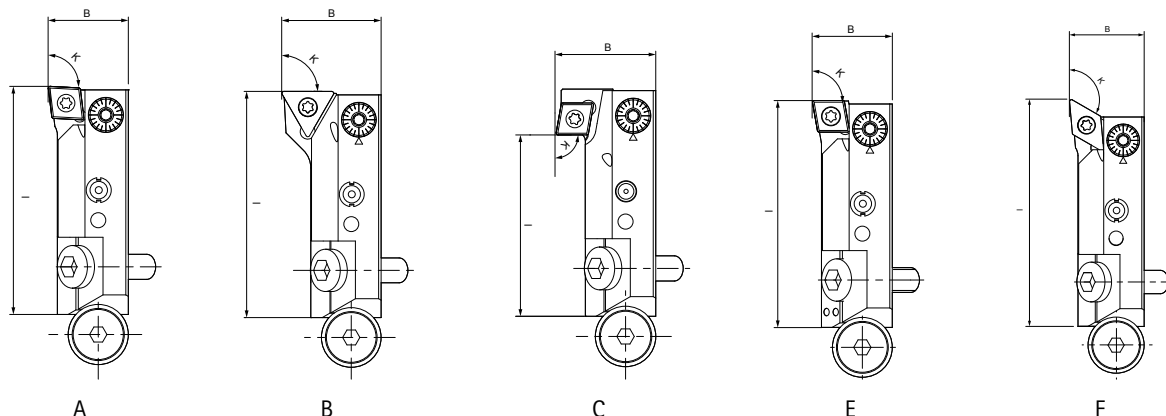

Tipo	l	B	K	Ejecución	Inserto de corte	Especificación	Referencia
A	45,5	16	93°	derecha	CC..0602	MBO501-R-093-16-CC_0602	10030384
A	45,5	16	93°	izquierda	CC..0602	MBO501-L-093-16-CC_0602	30415298
B	45,5	20	90°	derecha	TC..1102	MBO501-R-090-20-TC_1102	30355664
B	45,5	20	90°	izquierda	TC..1102	MBO501-L-090-20-TC_1102	30353989
C	36	20	90°	hacia atrás	CC..0602	MBO501-B-090-20-CC_0602	30415297
A	45,5	16	95°	derecha	CC..0602	MBO501-R-095-16-CC_0602	10078197
A	45,5	16	95°	izquierda	CC..0602	MBO501-L-095-16-CC_0602	30415299
E	45,5	16	90°	derecha	CC..0602	MBO501-R-090-16-CC_0602	10078198
E	45,5	16	90°	izquierda	CC..0602	MBO501-L-090-16-CC_0602	10078199

Con ajuste de precisión de 10 μ m | Carrera de ajuste relativa a la medida B + 0,6 mm \varnothing
Plazo de entrega a petición.

Disponibles a petición

Tipo	l	B	k	Ejecución	Inserto de corte	Especificación	Referencia
F	48,5	16	120° (5°)	izquierda	DC..0702	MBO501-L-120-16-DC_0702	30415305
F	45,8	16	120° (5°)	derecha	DC..0702	MBO501-R-120-16-DC_0702	30415302
A	45,5	22	95°	izquierda	CC..09T3	MBO501-L-095-22-CC_09T3	30415304
A	45,5	22	95°	derecha	CC..09T3	MBO501-R-095-22-CC_09T3	30415301

ModulBore-Plus – Cartucho para plaquita de corte reversible para cabezal de taladrado de precisión

Tipo	l	B	K	Ejecución	Inserto de corte	Especificación	Referencia
A	45,5	16	93°	derecha	CC..0602	MBO511-R-093-16-CC_0602	30415307
A	45,5	16	95°	derecha	CC..0602	MBO511-R-095-16-CC_0602	30415308
A	45,5	16	90°	derecha	CC..0602	MBO511-R-090-16-CC_0602	30415306

Con ajuste de precisión de 2 μ m | Carrera de ajuste relativa a la medida B + 0,5 mm \varnothing
Plazo de entrega a petición.

Adaptador MBS

Mango SK según ISO 7388-1, forma AD/AF

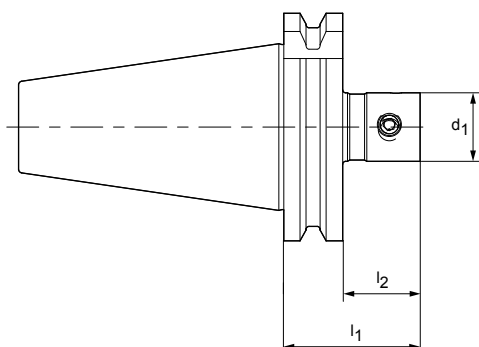

SK	d ₁ Tamaño MBS	l ₁	l ₂	Especificación	Referencia
40	18,5	60	40	MBS101-N-185-040-SK040-S	30415332
40	24,5	60	40	MBS101-N-245-060-SK040-S	30415333
40	32	60	40	MBS101-N-320-060-SK040-S	30415334
40	42	60	40	MBS101-N-420-060-SK040-S	30415335
40	55	65	45	MBS101-N-550-065-SK040-S	30415336
50	18,5	40	20	MBS101-N-185-040-SK050-S	30415337
50	24,5	40	20	MBS101-N-245-040-SK050-S	30415338
50	32	60	40	MBS101-N-320-060-SK050-S	30415339
50	42	60	40	MBS101-N-420-060-SK050-S	30415340
50	55	60	40	MBS101-N-550-060-SK050-S	30415341
50	72	65	45	MBS101-N-720-065-SK050-S	30415342

Plazo de entrega a petición.

Adaptador MBS

Mango BT según ISO 7388-2, forma J (JIS B 6339)

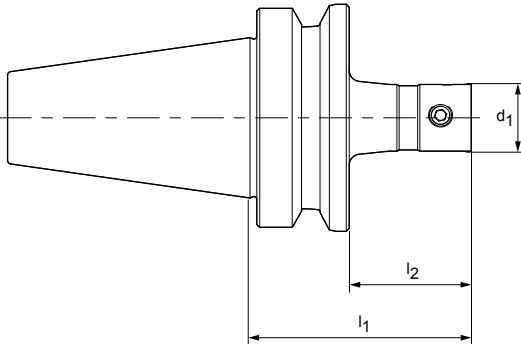

BT	d ₁ Tamaño MBS	l ₁	l ₂	Especificación	Referencia
40	18,5	40	33	MBS101-N-185-060-BT040-S	30415344
40	24,5	40	33	MBS101-N-245-060-BT040-S	30415345
40	32	60	33	MBS101-N-320-060-BT040-S	30415346
40	42	60	33	MBS101-N-420-060-BT040-S	30415347
40	55	60	33	MBS101-N-550-065-BT040-S	30415348
50	18,5	40	-	MBS101-N-185-040-BT050-S	30415349
50	24,5	40	-	MBS101-N-245-040-BT050-S	30415350
50	32	60	22	MBS101-N-320-060-BT050-S	30415351
50	42	60	22	MBS101-N-420-060-BT050-S	30415352
50	55	60	27	MBS101-N-550-065-BT050-S	30415353
50	72	60	32	MBS101-N-720-070-BT050-S	30415354

Plazo de entrega a petición.

Adaptador MBS

Mango HSK-A según DIN 69893-1

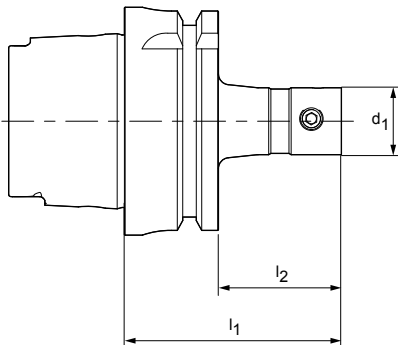

HSK-A	d_1 Tamaño MBS	l_1	l_2	Especificación	Referencia
63	18,5	60	34	MBS101-N-185-060-HSK-A063-S	30415367
63	24,5	60	34	MBS101-N-245-060-HSK-A063-S	30415368
63	32	60	34	MBS101-N-320-060-HSK-A063-S	30415369
63	42	70	44	MBS101-N-420-070-HSK-A063-S	30415370
63	55	80	54	MBS101-N-550-080-HSK-A063-S	30415371
63	72	95	69	MBS101-N-720-095-HSK-A063-S	30415372
100	32	70	41	MBS101-N-320-070-HSK-A100-S	30415373
100	42	80	51	MBS101-N-420-080-HSK-A100-S	30415374
100	55	90	61	MBS101-N-420-550-HSK-A100-S	30415375
100	72	105	76	MBS101-N-720-105-HSK-A100-S	30415376

Plazo de entrega a petición.

Alargaderas MBS

MBS a MBS

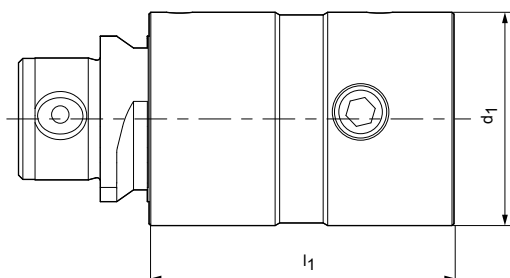

d_1 Tamaño MBS	l_1	Especificación	Referencia
18,5	30	MBS185-MBS185-030-01	30415380
18,5	35	MBS185-MBS185-035-01	30415381
24,5	30	MBS245-MBS245-030-01	30415382
24,5	35	MBS245-MBS245-035-01	30415383
24,5	45	MBS245-MBS245-045-01	30415384
32	40	MBS320-MBS320-040-01	30415385
32	50	MBS320-MBS320-050-01	30415386
32	60	MBS320-MBS320-060-01	30415387
42	50	MBS420-MBS420-050-01	30415388
42	60	MBS420-MBS420-060-01	30415389
42	80	MBS420-MBS420-080-01	30415390
55	70	MBS550-MBS550-070-01	30415391
55	90	MBS550-MBS550-090-01	30415392
55	105	MBS550-MBS550-105-01	30415393
72	75	MBS720-MBS720-075-01	30415394
72	100	MBS720-MBS720-100-01	30415395
72	135	MBS720-MBS720-135-01	30415396

Plazo de entrega a petición.

Reductores MBS

MBS a MBS

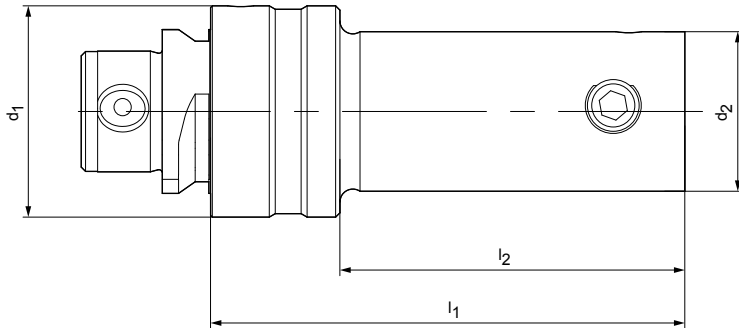

d_1 Tamaño MBS	d_2 Tamaño MBS	l_1	l_2	Especificación	Referencia
24,5	18,5	30	15	MBS245-MBS185-030-01	30415399
32	18,5	30	51	MBS320-MBS185-030-01	30415401
32	24,5	40	25	MBS320-MBS245-040-01	30415403
42	18,5	35	15	MBS420-MBS185-035-01	30415405
42	24,5	45	25	MBS420-MBS245-045-01	30415407
42	32	45	25	MBS420-MBS320-045-01	30415409
55	18,5	40	15	MBS550-MBS185-040-01	30415411
55	24,5	50	25	MBS550-MBS245-050-01	30415413
55	32	50	25	MBS550-MBS320-050-01	30415415
55	42	55	30	MBS550-MBS420-055-01	30415417
72	42	60	30	MBS720-MBS420-060-01	30415419
72	55	60	30	MBS720-MBS550-060-01	30415420

Plazo de entrega a petición.

ModulBore – Mandriles

Con ranura transversal y MBS

Mango MBS

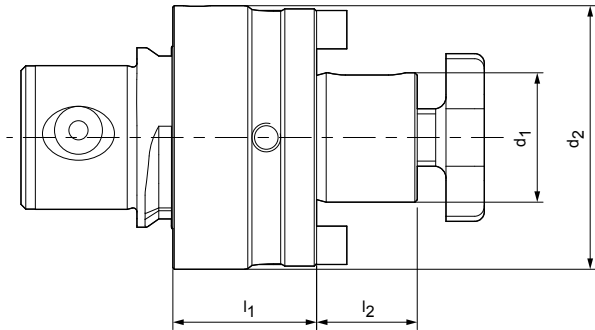

Tamaño MBS	d_1	d_2	l_1	l_2	Especificación	Referencia
MBS420	27	42	30	21	MCA-MBS420-27-30-1-0-W	30415312
MBS550	27	55	30	21	MCA-MBS550-27-30-1-0-W	30415313
MBS720	40	72	35	27	MCA-MBS720-40-35-1-0-W	30415314

Plazo de entrega a petición.

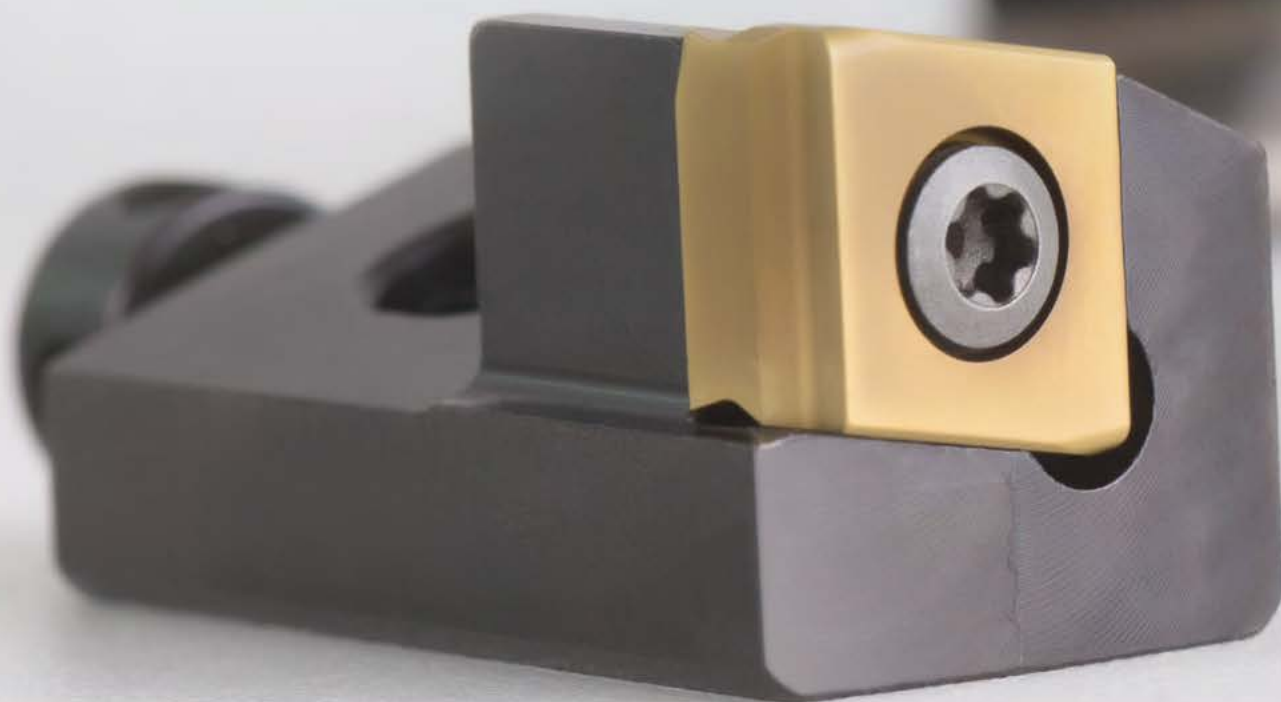

SOPORTE DE SUJECCIÓN CORTO

Además de la posibilidad de ajuste con un gran recorrido de ajuste, los soportes de sujeción cortos ofrecen múltiples opciones para diferentes aplicaciones, gracias a su sustitución fácil y rápida. Los soportes de sujeción cortos se utilizan tanto para mecanizados exteriores como interiores. En caso de modificaciones de ángulos de bisel, por ejemplo, o en caso de reparación, los soportes de sujeción cortos pueden sustituirse fácilmente.

La gama de soportes de sujeción cortos MAPAL cubre una gran parte de las variantes de montaje de diseño. Además de los soportes de sujeción cortos ISO estandarizados, está disponible una serie de soportes de sujeción compactos para insertos de corte reversibles tangenciales y radiales. Estos ofrecen un margen constructivo aún mayor para el diseño de herramientas especiales gracias a las longitudes más cortas.

Si el cliente lo solicita, MAPAL suministra también soportes de sujeción cortos y soportes de sujeción compactos de fabricación especial.

Soporte de sujeción corto

Código de denominación _____	644
Soporte de sujeción corto ISO _____	646
Soportes de sujeción compactos _____	650
Soportes de sujeción compactos para insertos de corte tangenciales _	656
Accesorios _____	660

Comparación de tamaño de los soportes de sujeción compactos MAPAL con los soportes de sujeción cortos ISO

Ejemplo: tamaño del inserto de corte 09

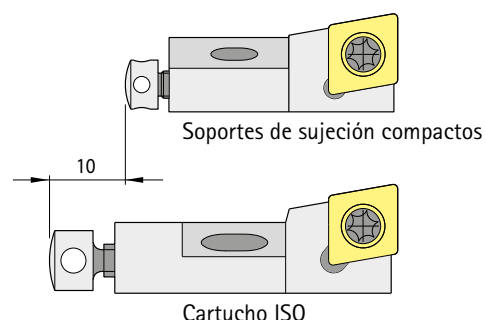

Código de denominación

Soporte de sujeción corto y soportes de sujeción compactos

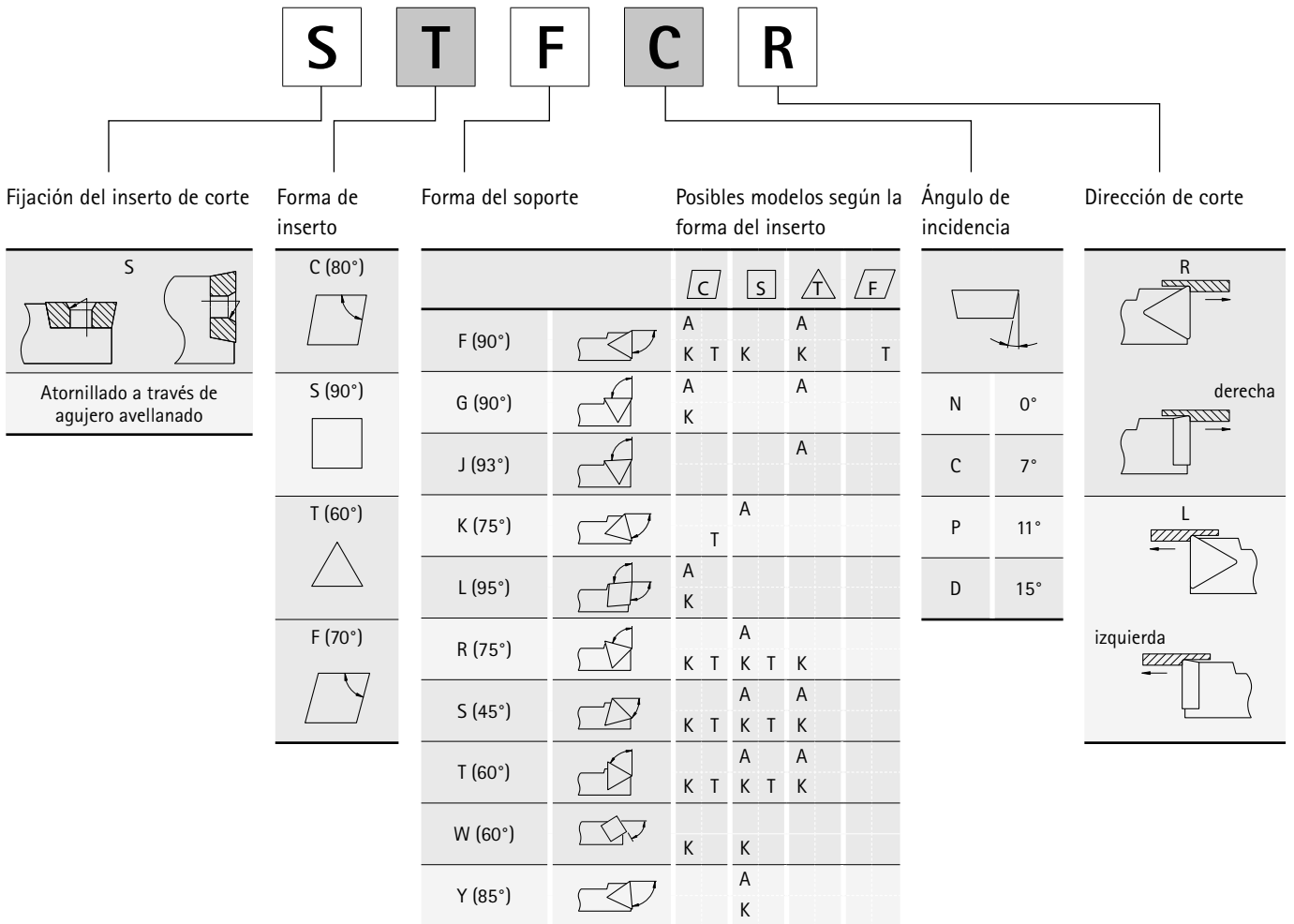

A = Soporte de sujeción corto
 K = Soporte de sujeción compacto
 T = Soporte de sujeción compacto para insertos de corte tangenciales

Soporte de sujeción compacto con ángulo especial Indicación de la forma del soporte directamente a través del ángulo de ajuste

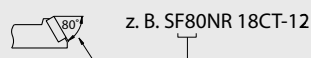
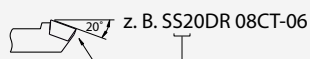

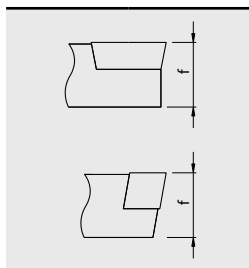
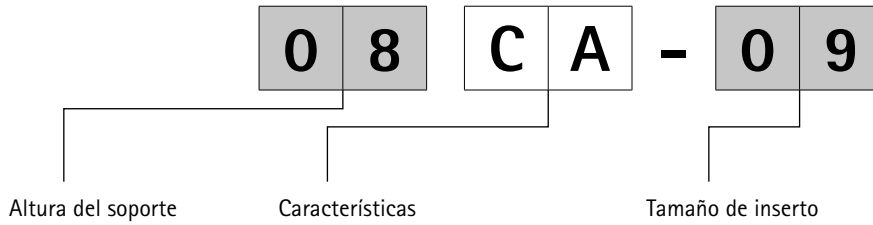

Datos de altura	
Indicador	[mm]
06	6,0
08	8,0
10	10,0
12	12,0
14	14,0
18	18,0

1.ª pos.	Significado
C	Soporte de sujeción corto (Cartridge)
2.ª pos.	Significado
A	Soporte de sujeción corto según DIN 4985
K	Soporte de sujeción compacto similar a DIN 4985
T	Soporte de sujeción compacto similar a DIN 4985 para insertos de corte tangenciales

Circunferencia inscrita				
	C	S	T	F
d [mm]				
5,56	05	-	09	-
6,35	06	06	11	06
9,525	09	09	16	09
12,7	12	12	-	12

Soporte de sujeción corto ISO

Forma F, G

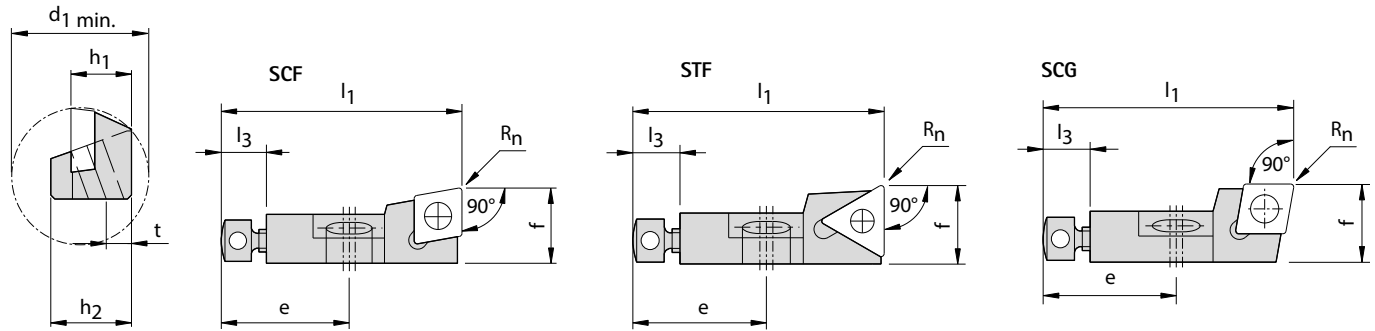

Dibujos en ejecución derecha, ejemplo SCFCR.

Serie preferente disponible en stock

	Especificación	Placa de corte correspondiente	Dimensiones									Grupo de accesorios*	Referencia
			h_1	f (referido a R_n)	R_n	l_1	e	l_3	h_2	t	$d_1 \text{ min.}$		
SCF...	SCFCR 08CA-06	CC_0602__	8	10	0,4	32	17	6	9,5	4,5	25	3	30011050
	SCFCL 08CA-06	CC_0602__	8	10	0,4	32	17	6	9,5	4,5	25	3	30011051
	SCFPR 08CA-06	CP_0602__	8	10	0,4	32	17	6	9,5	4,5	25	3	30011052
	SCFPL 08CA-06	CP_0602__	8	10	0,4	32	17	6	9,5	4,5	25	3	30011053
	SCFCR 10CA-09	CC_09T3__	10	14	0,8	50	20	8	13	5	40	5	30011054
	SCFCR 12CA-12	CC_1204__	12	20	0,8	55	20	8	17	6	50	1	30011056
	SCFCL 12CA-12	CC_1204__	12	20	0,8	55	20	8	17	6	50	1	30011057
STF...	STFCR 08CA-09	TC_0902__	8	10	0,4	32	17	6	9,5	4,5	25	2	30011058
	STFCR 10CA-11-02	TC_1102__	10	14	0,4	50	20	8	13	5	40	4	30011060
	STFCR 12CA-16	TC_16T3__	12	20	0,8	55	20	8	17	6	50	6	30011062
SCG...	SCGCR 08CA-06	CC_0602__	8	10	0,4	32	17	6	9,5	4,5	25	3	30011064
	SCGCL 08CA-06	CC_0602__	8	10	0,4	32	17	6	9,5	4,5	25	3	30011065
	SCGCR 10CA-09	CC_09T3__	10	14	0,8	50	20	8	13	5	40	5	30011068

* véanse las páginas 660-661

Más formas de corte, tamaños y ángulos de incisión a petición.

Volumen de suministro: Soporte de sujeción con piezas de montaje. Las plaquitas de corte reversibles y los accesorios deben pedirse por separado.

Medidas en mm.

Cartucho ISO

Forma J, K, L

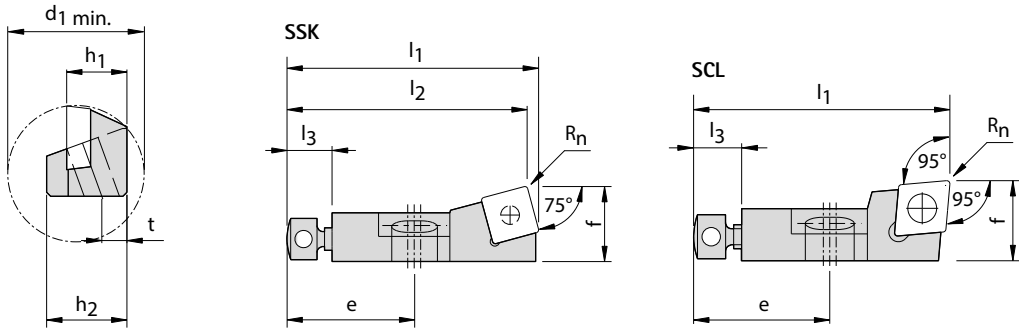

Dibujos en ejecución derecha, ejemplo STJCR.

Serie preferente disponible en stock

	Especificación	Placa de corte correspondiente	Dimensiones										Grupo de accesorios*	Referencia
			h_1	f (referido a R_n)	R_n	l_1	l_2	e	l_3	h_2	t	d_1 min.		
SSK...	SSKCR 10CA-09	SC_09T3__	10	14	0,8	52,2	50	20	8	13	5	40	5	30011086
	SSKCL 10CA-09	SC_09T3__	10	14	0,8	52,2	50	20	8	13	5	40	5	30011087
	SSKCR 12CA-12	SC_1204__	12	20	0,8	58,1	55	20	8	17	6	50	1	30011088
SCL...	SCLCR 10CA-09	CC_09T3__	10	14	0,8	50	-	20	8	13	5	40	5	30011094
	SCLCL 10CA-09	CC_09T3__	10	14	0,8	50	-	20	8	13	5	40	5	30011095
	SCLCL 12CA-12	CC_1204__	12	20	0,8	55	-	20	8	17	6	50	1	30011097

* véanse las páginas 660-661

Más formas de corte, tamaños y ángulos de incisión a petición.
 Volumen de suministro: Soporte de sujeción con piezas de montaje. Las plaquitas de corte reversibles y los accesorios deben pedirse por separado.
 Medidas en mm.

Cartucho ISO

Forma R, S

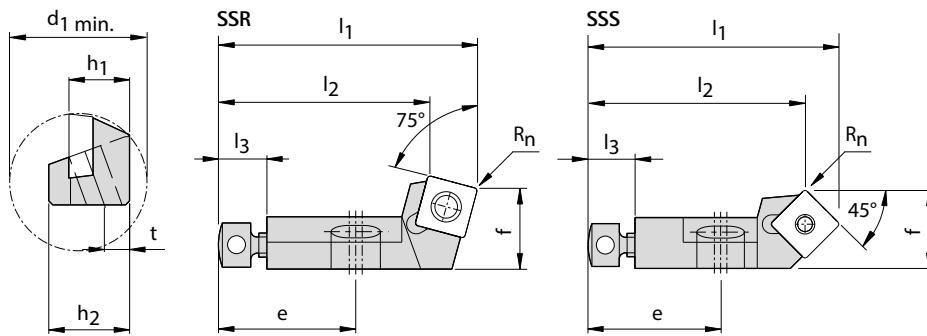

Dibujos en ejecución derecha, ejemplo SSRCR.

Serie preferente disponible en stock

	Especificación	Placa de corte correspondiente	Dimensiones										Grupo de accesorios*	Referencia
			h_1	f (referido a R_n)	R_n	l_1	l_2	e	l_3	h_2	t	d_1 min.		
SSR...	SSRCR 08CA-06	SC_0602__	8	10	0,4	32	26,4	17	6	9,5	4,5	25	3	30011098
	SSRCR 10CA-09	SC_09T3__	10	14	0,8	50	41,3	20	8	13	5	40	5	30011100
	SSRCR 12CA-12	SC_1204__	12	20	0,8	55	43,5	20	8	17	6	50	1	30011102
	SSRCL 12CA-12	SC_1204__	12	20	0,8	55	43,5	20	8	17	6	50	1	30011103
SSS...	SSSCR 08CA-06	SC_0602__	8	10	0,4	32,4	28	17	6	9,5	4,5	25	3	30011104
	SSSCL 08CA-06	SC_0602__	8	10	0,4	32,4	28	17	6	9,5	4,5	25	3	30011105
	SSSCR 10CA-09	SC_09T3__	10	14	0,8	50,1	44	20	8	13	5	40	5	30011106

* véanse las páginas 660-661

Más formas de corte, tamaños y ángulos de incisión a petición.

Volumen de suministro: Soporte de sujeción con piezas de montaje. Las plaquitas de corte reversibles y los accesorios deben pedirse por separado.

Medidas en mm.

Cartucho ISO

Forma T, Y

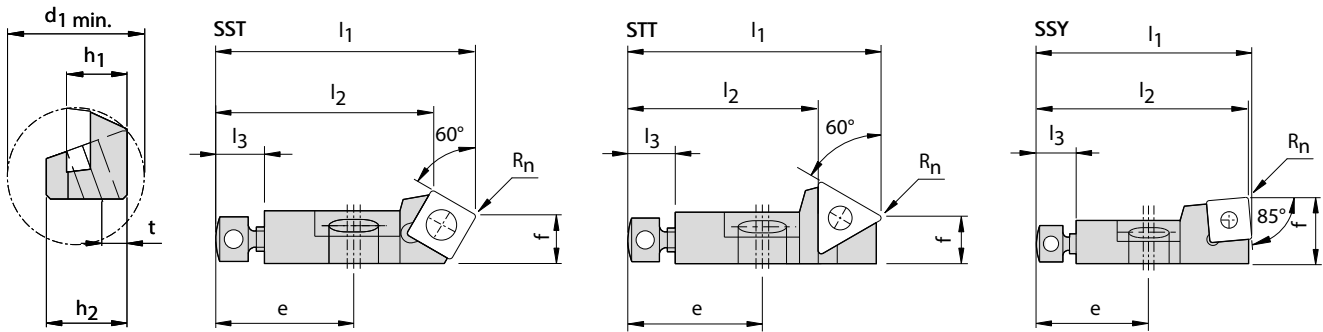

Dibujos en ejecución derecha, ejemplo SSTCR.

Serie preferente disponible en stock

	Especificación	Placa de corte correspondiente	Dimensiones										Grupo de accesorios*	Referencia
			h_1	f (referido a R_n)	R_n	l_1	l_2	e	l_3	h_2	t	$d_1 \text{ min.}$		
SST...	SSTCR 10CA-09	SC_09T3__	10	13,3	0,8	50	40,6	20	8	13	5	40	5	30011118
	SSTCL 10CA-09	SC_09T3__	10	13,3	0,8	50	40,6	20	8	13	5	40	5	30011119
	SSTCR 12CA-12	SC_1204__	12	18,9	0,8	55	44,8	20	8	17	6	50	1	30011120
STT...	STTCR 08CA-09	TC_0902__	8	10,3	0,4	32	24,6	17	6	9,5	4,5	25	2	30011122
	STTCR 10CA-11-02	TC_1102__	10	14	0,4	50	41,4	20	8	13	5	40	4	30011124
SSY...	SSYCR 10CA-09	SC_09T3__	10	14	0,8	50,8	50	20	8	13	5	40	5	30011130
	SSYCR 12CA-12	SC_1204__	12	20	0,8	56	55	20	8	17	6	50	1	30011132

* véanse las páginas 660-661

Más formas de corte, tamaños y ángulos de incisión a petición.
 Volumen de suministro: Soporte de sujeción con piezas de montaje. Las plaquitas de corte reversibles y los accesorios deben pedirse por separado.
 Medidas en mm.

Soportes de sujeción compactos

Forma F

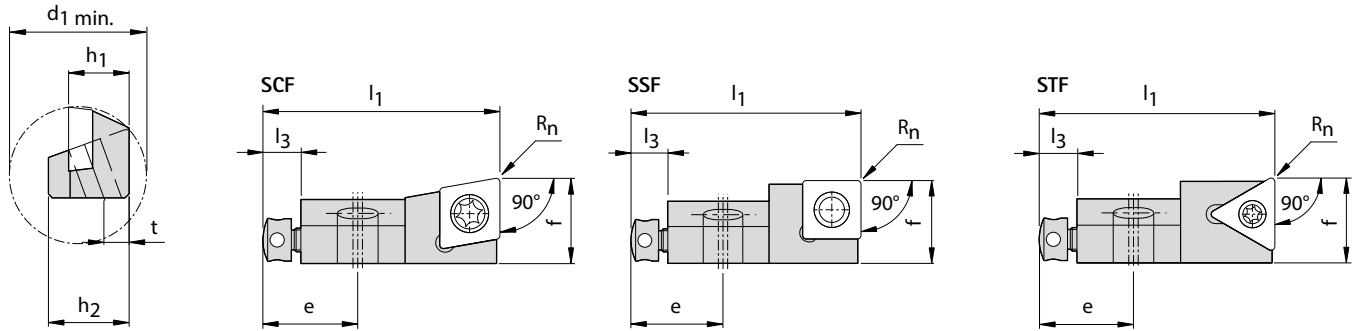

Dibujos en ejecución derecha, ejemplo SCFCR.

Serie preferente disponible en stock

	Especificación	Placa de corte correspondiente	Dimensiones									Grupo de accesorios*	Referencia
			h_1	f (referido a R_n)	R_n	l_1	e	l_3	h_2	t	$d_1 \text{ min.}$		
SCF...	SCFCR 06CK-06 V1	CC_0602_	6	8,5	0,4	25	11	5	6	2,5	18	9	30011134
	SCFCL 06CK-06 V1	CC_0602_	6	8,5	0,4	25	11	5	6	2,5	18	9	30011135
	SCFCR 06CK-06 V2	CC_0602_	6	9,7	0,4	25	11	5	6	2,5	18	9	30011136
	SCFCR 10CK-09	CC_09T3_	10	14	0,8	40	17	8	15	5	33	14	30011138
	SCFCL 10CK-09	CC_09T3_	10	14	0,8	40	17	8	15	5	33	14	30011139
	SCFCR 12CK-12	CC_1204_	12	18	0,8	50	20	8	16	5	37	7	30011140
	SCFCL 12CK-12	CC_1204_	12	18	0,8	50	20	8	16	5	37	7	30011141
SSF...	SSFPR 08CK-06	SP_0603_	8	10	0,4	32	17	5	10	4,5	24	13	30011142
	SSFPR 10CK-09	SC_09T3_	10	14	0,8	44	17	8	15	5	33	16	30011144
	SSFPR 12CK-12	SC_1204_	12	18	0,8	50	20	8	16	5	37	7	30011146
	SSFCL 12CK-12	SC_1204_	12	18	0,8	50	20	8	16	5	37	7	30011147
STF...	STFCR 06CK-09	TC_0902_	6	10	0,4	25	11	5	6	2,5	18	17	30011148
	STFCR 10CK-11	TC_1102_	10	14	0,4	40	17	8	15	5	33	11	30011150
	STFCR 12CK-16	TC_16T3_	12	18	0,8	50	20	8	16	5	37	12	30011152

* véanse las páginas 660-661

Más formas de corte, tamaños y ángulos de incisión a petición.

Volumen de suministro: Soporte de sujeción con piezas de montaje. Las plaquitas de corte reversibles y los accesorios deben pedirse por separado.

Medidas en mm.

Soportes de sujeción compactos

Forma G, L

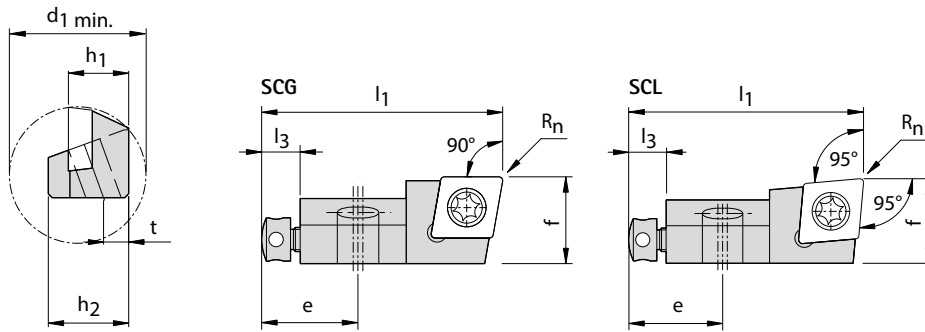

Dibujos en ejecución derecha, ejemplo SCGCR.

Serie preferente disponible en stock

	Especificación	Placa de corte correspondiente	Dimensiones									Grupo de accesorios*	Referencia
			h_1	f (referido a R_n)	R_n	l_1	e	l_3	h_2	t	$d_1 \text{ min.}$		
SCG...	SCGCR 06CK-06 V1	CC_0602__	6	8,5	0,4	25	11	5	6	2,5	18	10	30011154
	SCGCL 06CK-06 V1	CC_0602__	6	8,5	0,4	25	11	5	6	2,5	18	10	30011155
	SCGCR 10CK-09	CC_09T3__	10	14	0,8	40	17	8	15	5	33	15	30011158
	SCGCL 10CK-09	CC_09T3__	10	14	0,8	40	17	8	15	5	33	15	30011159
	SCGCR 12CK-12	CC_1204__	12	18	0,8	50	20	8	16	5	37	8	30011160
	SCGCL 12CK-12	CC_1204__	12	18	0,8	50	20	8	16	5	37	8	30011161
SCL...	SCLCR 06CK-06 V1	CC_0602__	6	8,5	0,4	25	11	5	6	2,5	18	10	30011162
	SCLCL 06CK-06 V1	CC_0602__	6	8,5	0,4	25	11	5	6	2,5	18	10	30011163
	SCLCR 06CK-06 V2	CC_0602__	6	9,7	0,4	25	11	5	6	2,5	18	10	30011164
	SCLCL 06CK-06 V2	CC_0602__	6	9,7	0,4	25	11	5	6	2,5	18	10	30011165
	SCLCR 10CK-09	CC_09T3__	10	14	0,8	40	17	8	15	5	33	15	30011166
	SCLCL 10CK-09	CC_09T3__	10	14	0,8	40	17	8	15	5	33	15	30011167
	SCLCR 12CK-12	CC_1204__	12	18	0,8	50	20	8	16	5	37	7	30011168
	SCLCL 12CK-12	CC_1204__	12	18	0,8	50	20	8	16	5	37	7	30011169

* véanse las páginas 660-661

Más formas de corte, tamaños y ángulos de incisión a petición.

Volumen de suministro: Soporte de sujeción con piezas de montaje. Las plaquitas de corte reversibles y los accesorios deben pedirse por separado.

Medidas en mm.

Soportes de sujeción compactos

Forma R

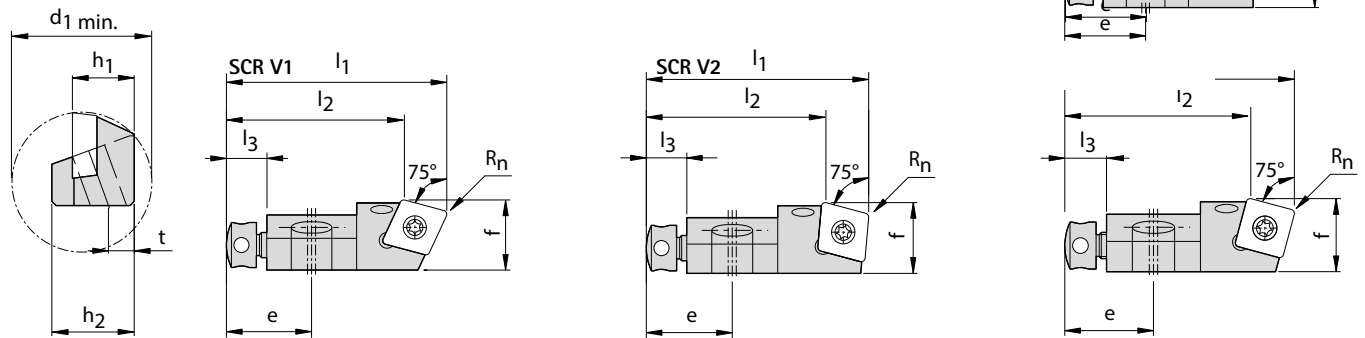

Dibujos en ejecución derecha, ejemplo SCR CR.

Serie preferente disponible en stock

	Especificación	Placa de corte correspondiente	Dimensiones										Grupo de accesorios*	Referencia
			h_1	f (referido a R_n)	R_n	l_1	l_2	e	l_3	h_2	t	$d_1 \text{ min.}$		
SCR...V1	SCR CR 06CK-06 V1	CC_0602__	6	9,7	0,4	25	19,2	11	5	6	2,5	18	9	30011170
	SCR CR 10CK-09 V1	CC_09T3__	10	14	0,8	44	35,5	17	8	15	5	33	14	30011172
SCR...V2	SCR CR 06CK-06 V2	CC_0602__	6	10	0,4	25	19,2	11	5	6	2,5	18	9	30011174
	SCR CR 10CK-09 V2	CC_09T3__	10	14	0,8	44	35,5	17	8	15	5	33	16	30011176
SSR...V1	SSR PR 08CK-06	SP_0603__	8	10	0,4	32	26,3	17	5	10	4,5	24	13	30011178
	SSR CR 10CK-09	SC_09T3__	10	14	0,8	44	35,7	17	8	15	5	33	16	30011180
	SSR CL 10CK-09	SC_09T3__	10	14	0,8	44	35,7	17	8	15	5	33	16	30011181
	SSR CR 12CK-12	SC_1204__	12	18	0,8	50	38,6	20	8	16	5	37	7	30011182
STR...V1	STR CR 10CK-11	TC_1102__	10	14	0,4	40	30,4	17	8	15	5	33	11	30011186
	STR CR 12CK-16	TC_16T3__	12	18	0,8	50	36,1	20	8	16	5	37	12	30011188

* véanse las páginas 660-661

Más formas de corte, tamaños y ángulos de incisión a petición.

Volumen de suministro: Soporte de sujeción con piezas de montaje. Las plaquitas de corte reversibles y los accesorios deben pedirse por separado.

Medidas en mm.

Soportes de sujeción compactos

Forma S

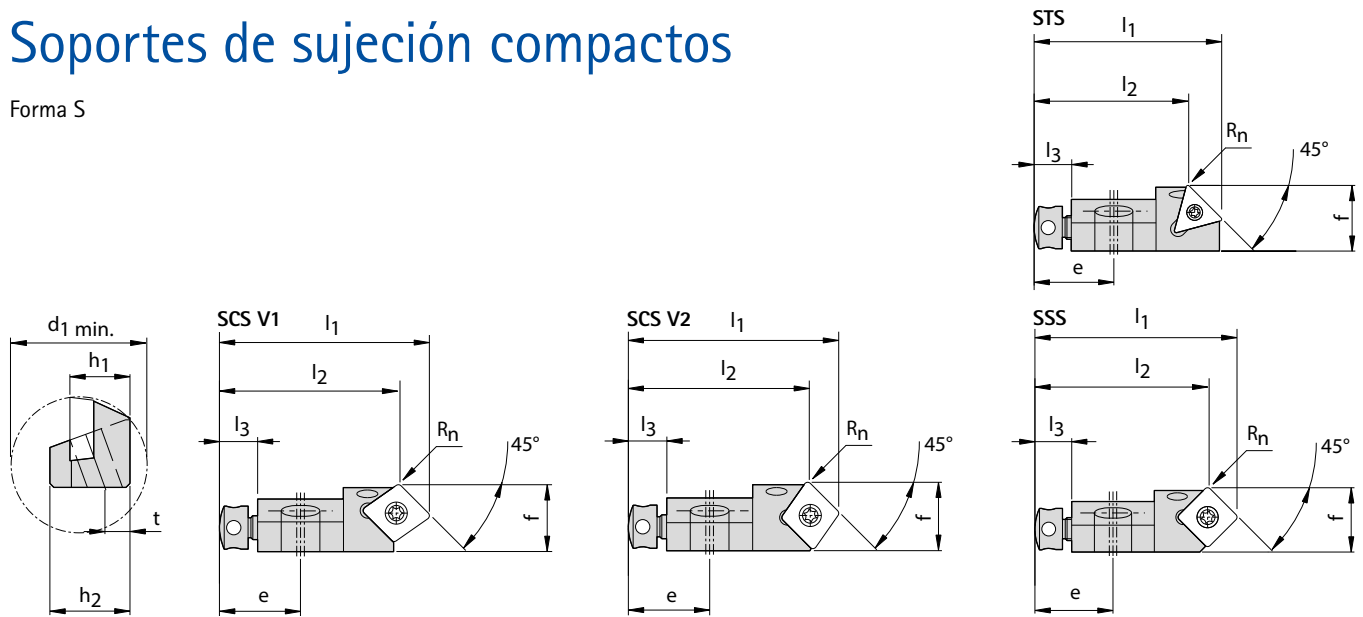

Dibujos en ejecución derecha, ejemplo SCSCR.

Serie preferente disponible en stock

	Especificación	Placa de corte correspondiente	Dimensiones										Grupo de accesorios*	Referencia
			h_1	f	R_n	l_1	l_2	e	l_3	h_2	t	$d_1 \text{ min.}$		
SCS...V1	SCSCR 06CK-06 V1	CC_0602__	6	9,7	0,4	25	20,8	11	5	6	2,5	18	9	30011190
	SCSCR 10CK-09 V1	CC_09T3__	10	14	0,8	44	37,8	17	8	15	5	33	14	30011192
SCS...V2	SCSCR 06CK-06 V2	CC_0602__	6	10	0,4	25	20,8	11	5	6	2,5	18	9	30011194
	SCSCR 10CK-09 V2	CC_09T3__	10	14,3	0,8	44	37,8	17	8	15	5	33	14	30011196
SSS...	SSSPR 08CK-06	SP_0603__	8	10	0,4	32	27,8	17	5	10	4,5	24	13	30011198
	SSSPL 08CK-06	SP_0603__	8	10	0,4	32	27,8	17	5	10	4,5	24	13	30011199
	SSSCR 10CK-09	SC_09T3__	10	14	0,8	44	37,9	17	8	15	5	33	14	30011200
	SSSCL 10CK-09	SC_09T3__	10	14	0,8	44	37,9	17	8	15	5	33	14	30011201
	SSSCR 12CK-12	SC_1204__	12	18	0,8	50	41,7	20	8	16	5	37	7	30011202
STS...	STSCR 06CK-09	TC_0902__	6	10	0,4	25	18,9	11	5	6	2,5	18	17	30011204
	STSCR 10CK-11	TC_1102__	10	14	0,4	40	33	17	8	15	5	33	11	30011206

* véanse las páginas 660-661

Más formas de corte, tamaños y ángulos de incisión a petición.
 Volumen de suministro: Soporte de sujeción con piezas de montaje. Las plaquitas de corte reversibles y los accesorios deben pedirse por separado.
 Medidas en mm.

Soportes de sujeción compactos

Forma T

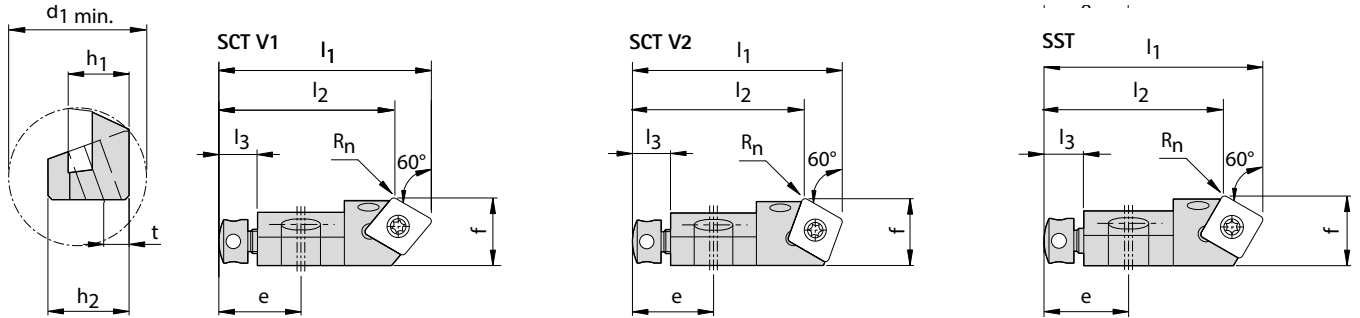

Dibujos en ejecución derecha, ejemplo SCTCR.

Serie preferente disponible en stock

	Especificación	Placa de corte correspondiente	Dimensiones										Grupo de accesorios*	Referencia
			h_1	f	R_n	l_1	l_2	e	l_3	h_2	t	$d_1 \text{ min.}$		
SCT...V1	SCTCR 06CK-06 V1	CC_0602__	6	9,7	0,4	25	19,8	11	5	6	2,5	18	9	30011210
	SCTCR 10CK-09 V1	CC_09T3__	10	14	0,8	44	36,5	17	8	15	5	33	14	30011212
SCT...V2	SCTCR 06CK-06 V2	CC_0602__	6	10	0,4	25	19,8	11	5	6	2,5	18	9	30011214
	SCTCR 10CK-09 V2	CC_09T3__	10	14	0,8	44	36,5	17	8	15	5	33	16	30011216
SST...	SSTPR 08CK-06	SP_0603__	8	10	0,4	32	26,9	17	5	10	4,5	24	13	30011218
	SSTCR 10CK-09	SC_09T3__	10	14	0,8	44	36,6	17	8	15	5	33	14	30011220
	SSTCR 12CK-12	SC_1204__	12	18	0,8	50	39,8	20	8	16	5	37	7	30011222
STT...	STTCR 06CK-09	TC_0902__	6	10	0,4	25	17,6	11	5	6	2,5	18	17	30011224
	STTCR 10CK-11	TC_1102__	10	14	0,4	40	31,4	17	8	15	5	33	11	30011226
	STTCR 12CK-16	TC_16T3__	12	18	0,8	50	37,5	20	8	16	5	37	12	30011228

* véanse las páginas 660-661

Más formas de corte, tamaños y ángulos de incisión a petición.
 Volumen de suministro: Soporte de sujeción con piezas de montaje. Las plaquitas de corte reversibles y los accesorios deben pedirse por separado.
 Medidas en mm.

Soportes de sujeción compactos

Forma W, Y

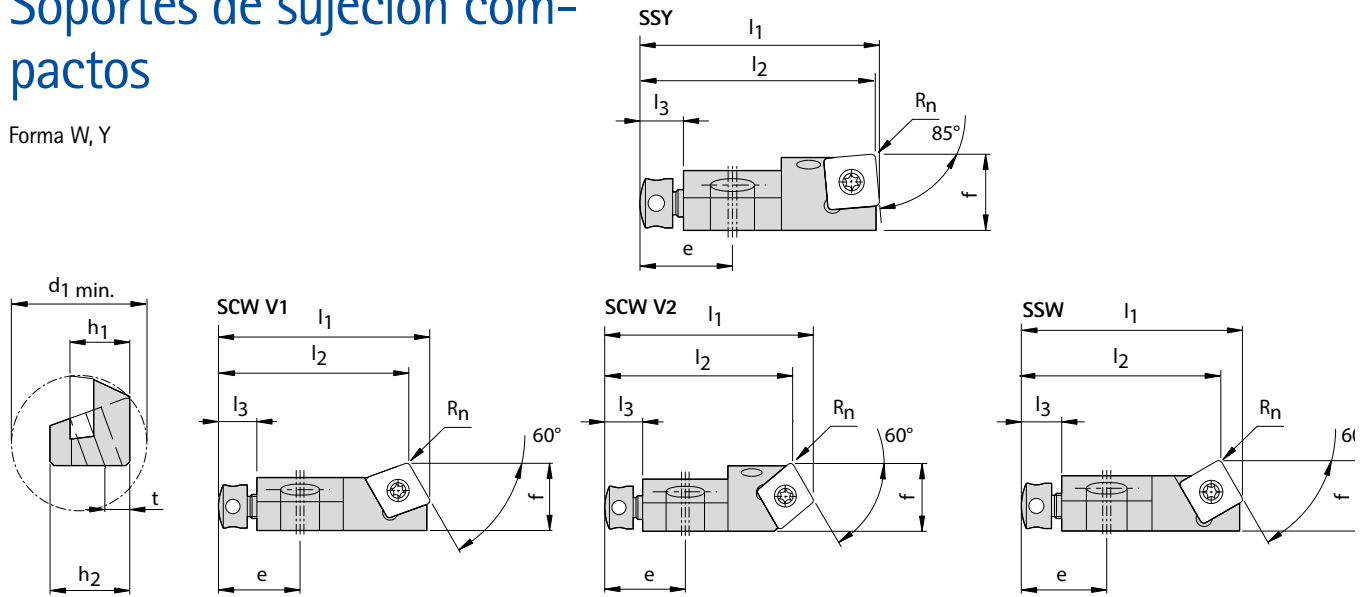

Dibujos en ejecución derecha, ejemplo SCWCR.

Serie preferente disponible en stock

	Especificación	Placa de corte correspondiente	Dimensiones										Grupo de accesorios*	Referencia
			h_1	f (referido a R_n)	R_n	l_1	l_2	e	l_3	h_2	t	$d_1 \text{ min.}$		
SCW...V1	SCWCR 06CK-06 V1	CC__0602__	6	9,7	0,4	25	22	11	5	6	2,5	18	9	30011230
	SCWCR 10CK-09 V1	CC__09T3__	10	14	0,8	44	39,6	17	8	15	5	33	16	30011232
SCW...V2	SCWCL 06CK-06 V2	CC__0602__	6	10	0,4	25	22	11	5	6	2,5	18	9	30011235
SSW...	SSWPR 08CK-06	SP__0603__	8	10	0,4	32	29,1	17	5	10	4,5	24	13	30011238
	SSWCL 10CK-09	SC__09T3__	10	14	0,8	44	39,7	17	8	15	5	33	16	30011241
	SSWCR 12CK-12	SC__1204__	12	18	0,8	50	44,1	20	8	16	5	37	7	30011242
	SSWCL 12CK-12	SC__1204__	12	18	0,8	50	44,1	20	8	16	5	37	7	30011243
SSY...	SSYPR 08CK-06	SP__0603__	8	10	0,4	32	31,5	17	5	10	4,5	24	13	30011250
	SSYCR 10CK-09	SC__09T3__	10	14	0,8	44	43,2	17	8	15	5	33	16	30011252
	SSYCL 10CK-09	SC__09T3__	10	14	0,8	44	43,2	17	8	15	5	33	16	30011253
	SSYCR 12CK-12	SC__1204__	12	18	0,8	50	49	20	8	16	5	37	7	30011254

* véanse las páginas 660-661

Más formas de corte, tamaños y ángulos de incisión a petición.

Volumen de suministro: Soporte de sujeción con piezas de montaje. Las plaquitas de corte reversibles y los accesorios deben pedirse por separado.

Medidas en mm.

Soportes de sujeción compactos para insertos de corte tangenciales

Forma F

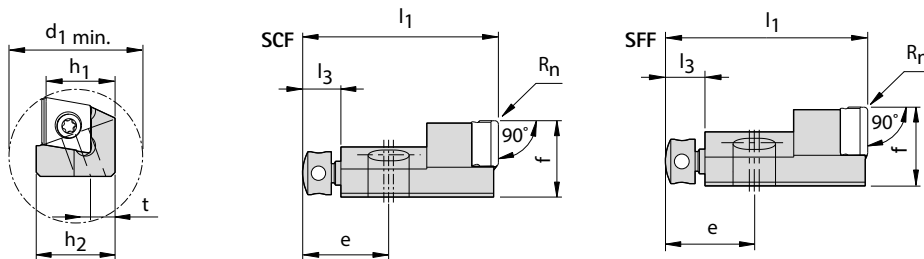

Dibujos en ejecución derecha, ejemplo SCFNR.

Serie preferente disponible en stock

	Especificación	Placa de corte correspondiente	Dimensiones										Grupo de accesorios*	Referencia
			h_1	f (referido a R_n)	R_n	l_1	l_2	e	l_3	h_2	t	d_1 min.		
SCF...	SCFNR 10CT-06	CTHQ0604__	10	11	0,8	29	-	12	5	10,5	5	40	22	30305015
	SCFNR 14CT-09	CTHQ0905__	14	16	0,8	41	-	18	8	16	7	65	24	30305018
	SCFNR 18CT-12	CTHQ1206__	18	22	0,8	43	-	18	8	20	7	75	26	30305020
	SCFDR 10 CT-06	CTHD0603__	10	11	0,8	29	-	12	5	10,5	5	40	22	30552260
	SCFDR 14 CT-09	CTHD09T3__	14	16	0,8	41	-	18	8	16	7	65	20	30552263
	SCFDR 18 CT-12	CTHD1204__	18	22	0,8	43	-	18	8	20	7	75	18	30552264
SFF...	SFFNR 10CT-06	FTHQ0604__	10	11	0,8	29	-	12	5	10,5	5	35	22	30305022
	SFFNR 14CT-09	FTHQ0905__	14	16	0,8	41	-	18	8	16	7	44	24	30305024
	SFFNR 18CT-12	FTHQ1206__	18	22	0,8	43	-	18	8	20	7	59,5	26	30305026

* véanse las páginas 660-661

Más formas de corte, tamaños y ángulos de incisión a petición.

Volumen de suministro: Soporte de sujeción con piezas de montaje. Las plaquitas de corte reversibles y los accesorios deben pedirse por separado.

Medidas en mm.

Soportes de sujeción compactos para insertos de corte tangenciales

Forma 80

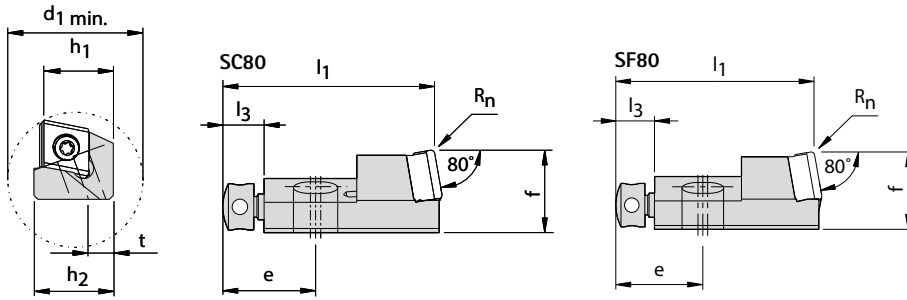

Dibujos en ejecución derecha, ejemplo SC80NR.

Serie preferente disponible en stock

Especificación	Placa de corte correspondiente	Dimensiones											Grupo de accesorios*	Referencia
		h_1	f (referido a R_n)	R_n	l_1	l_2	e	l_3	h_2	t	d_1 min.			
SC80...	SC80NR 10CT-06	CTHQ0604__	10	11	0,8	29	-	12	5	10,5	5	40	23	30305016
	SC80NR 14CT-09	CTHQ0905__	14	16	0,8	41	-	18	8	16	7	65	25	30305019
	SC80NR 18CT-12	CTHQ1206__	18	22	0,8	43	-	18	8	20	7	75	27	30305021
SF80...	SF80NR 10CT-06	FTHQ0604__	10	11	0,8	29	-	12	5	10,5	5	35	23	30305023
	SF80NR 14CT-09	FTHQ0905__	14	16	0,8	41	-	18	8	16	7	44	25	30305025
	SF80NR 18CT-12	FTHQ1206__	18	22	0,8	43	-	18	8	20	7	59,5	27	30305027

* véanse las páginas 660-661

Más formas de corte, tamaños y ángulos de incisión a petición.

Volumen de suministro: Soporte de sujeción con piezas de montaje. Las plaquitas de corte reversibles y los accesorios deben pedirse por separado.

Medidas en mm.

Soportes de sujeción compactos para insertos de corte tangenciales

Forma S, T, R

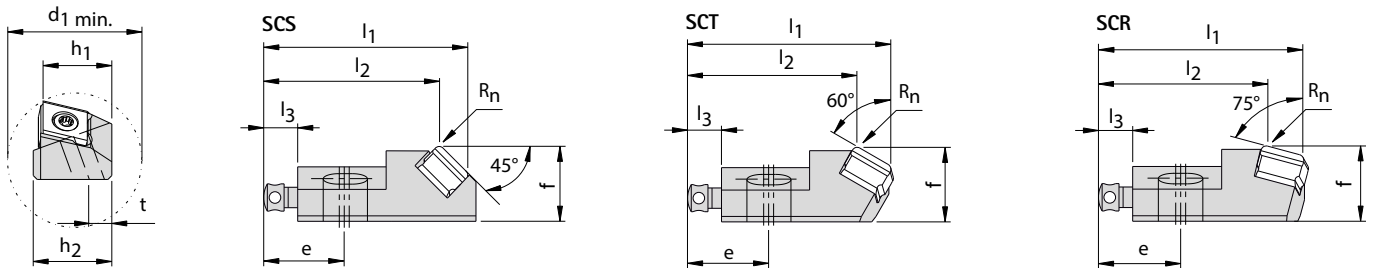

Dibujos en ejecución derecha, ejemplo SCSNR.

Serie preferente disponible en stock

	Especificación	Placa de corte correspondiente	Dimensiones										Grupo de accesorios*	Referencia
			h_1	f (referido a R_n)	R_n	l_1	l_2	e	l_3	h_2	t	$d_1 \text{ min.}$		
SCS...	SCSNR 14 CT-09	CTHQ0905__	14	16	0,8	42,5	36	18	8	16	7	65	30	30552283
SCT...	SCTNR 10 CT-06	CTHQ0604__	10	11	0,8	30	24,7	12	5	10,5	5	40	22	30552284
	SCTNR 14 CT-09	CTHQ0905__	14	16	0,8	42,5	34,4	18	8	16	7	65	20	30552285
	SCTDR 10 CT-06	CTHD0603__	10	11	0,8	30	24,7	12	5	10,5	5	40	22	30552274
SCR...	SCRNR 14 CT-09	CTHQ0905__	14	16	0,8	42,5	33,3	18	8	16	7	65	20	30552287

* véanse las páginas 660-661

Más formas de corte, tamaños y ángulos de incisión a petición.

Volumen de suministro: Soporte de sujeción con piezas de montaje. Las plaquitas de corte reversibles y los accesorios deben pedirse por separado.

Medidas en mm.

Soportes de sujeción compactos para insertos de corte tangenciales

Forma S, T, 20, R

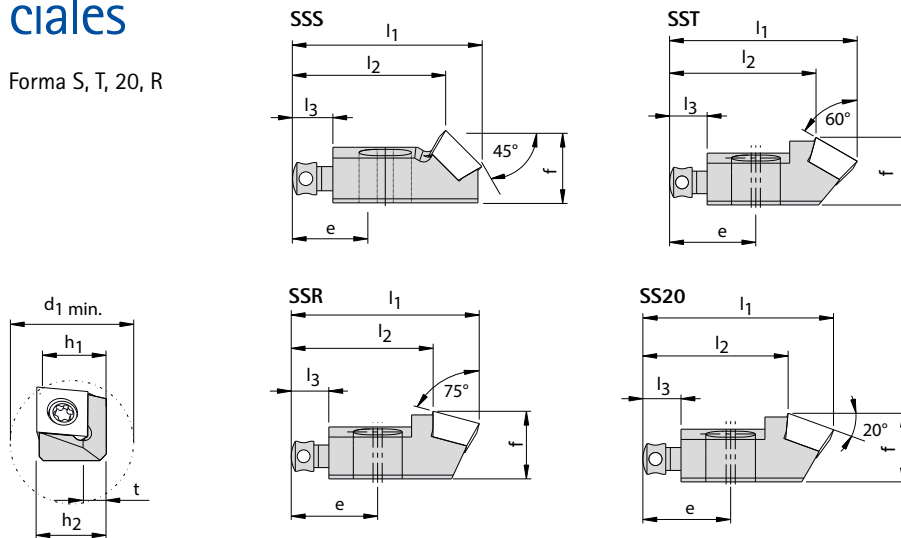

Dibujos en ejecución derecha, ejemplo SSDR.

Serie preferente disponible en stock

	Especificación	Placa de corte correspondiente	Dimensiones									Grupo de accesorios*	Referencia
			h_1	f	l_1	l_2	e	l_3	h_2	t	$d_1 \text{ min.}$		
SSS...	SSSDR 08CT-06	STHD0603__	8,5	9	23,5	19	11,5	5	8,2	3,2	33	28	30474905
	SSSDR 14CT-09	STHD09T3__	14	13,5	35,7	29	18	8	13,5	5	50	32	30474906
SST...	SSTDR 08 CT-06	STHD0603__	8,5	9	25	19,5	11,5	5	8,2	3,2	33	28	30552292
	SSTDR 14 CT-09	STHD09T3__	14	13,5	38	29,8	18	8	13,5	5	50	32	30552293
SS20...	SS20DR 08 CT-06	STHD0603__	8,5	9	25	19	11,5	5	8,2	3,2	33	28	30552294
	SS20DR 14 CT-09	STHD09T3__	14	13,5	38	29	18	8	13,5	5	50	32	30552295
SSR...	SSRDR 08 CT-06	STHD0603__	8,2	9	25	18,9	11,5	5	8,2	3,2	33	28	30552288
	SSRDR 14 CT-09	STHD09T3__	14	13,5	38	28,8	18	8	13,5	5	50	32	30552289

* véanse las páginas 660-661

Más formas de corte, tamaños y ángulos de incisión a petición.
 Volumen de suministro: Soporte de sujeción con piezas de montaje. Las plaquitas de corte reversibles y los accesorios deben pedirse por separado.
 Medidas en mm.

Accesorios para soportes de sujeción cortos ISO y soportes de sujeción compactos

En construcción radial y tangencial



Grupo de accesorios	Tornillo de fijación para cartucho			Tornillo de ajuste axial		Tornillo de ajuste radial		
	Denominación para pedido Tornillo de cabeza cilíndrica	Par de apriete [Nm]*	Referencia	Denominación para pedido Tornillo de cabeza de agujeros cruzados	Referencia	Denominación para pedido Tornillo prisionero	Referencia	
Soporte de sujeción corto ISO	1	DIN7984 M6x20-10.9	12	10019671	M5 x 10	10029150	DIN913 M4x10-45H	10003433
	2	DIN7984 M4x12-10.9	3	10019695	M3 x 8	10002641	DIN913 M3x6-45H	10003422
	3	DIN7984 M4x12-10.9	3	10019695	M3 x 8	10002641	DIN913 M3x6-45H	10003422
	4	DIN7984 M6x16-10.9	12	10019703	M5 x 10	10029150	DIN913 M4x8-45H	10003432
	5	DIN7984 M6x16-10.9	12	10019703	M5 x 10	10029150	DIN913 M4x8-45H	10003432
	6	DIN7984 M6x20-10.9	12	10019671	M5 x 10	10029150	DIN913 M4x10-45H	10003433
Soportes de sujeción compactos	7	MN685 M6x25-TX25-IP	12	30606074	M5 x 7	10018493	DIN915 M4x10-45H	10003900
	8	MN685 M6x25-TX25-IP	12	30606074	M5 x 7	10018493	DIN915 M4x10-45H	10003900
	9	MN685 M3x10-TX9-IP	1,8	30606065	M3 x 5	10025039	DIN915 M3x6-45H	10003894
	10	MN685 M3x10-TX9-IP	1,8	30606065	M3 x 5	10025039	DIN915 M3x6-45H	10003894
	11	MN685 M6x20-TX25-IP	12	30606068	M5 x 7	10018493	DIN915 M4x10-45H	10003900
	12	MN685 M6x25-TX25-IP	12	30606074	M5 x 7	10018493	DIN915 M4x10-45H	10003900
	13	MN685 M4x14-TX15-IP	3	30606067	M3 x 5	10025039	DIN915 M3x6-45H	10003894
	14	MN685 M6x20-TX25-IP	12	30606068	M5 x 7	10018493	DIN915 M4x10-45H	10003900
	15	MN685 M6x20-TX25-IP	12	30606068	M5 x 7	10018493	DIN915 M4x10-45H	10003900
	16	MN685 M6x20-TX25-IP	12	30606068	M5 x 7	10018493	DIN915 M4x10-45H	10003900
17	MN685 M3x10-TX9-IP	1,8	30606065	M3 x 5	10025039	DIN915 M3x6-45H	10003894	
Soportes de sujeción compactos tangenciales	18	ISO 4762-M6X25-12.9	12	10003620	M5 x 7	10018493	ISO 4028-M4x10-45H-KL	30351530
	19	ISO 4762-M6X25-12.9	12	10003620	M5 x 7	10018493	ISO 4028-M4x10-45H-KL	30351530
	20	DIN 7984-M6X20-10.9	12	10019671	M5 x 7	10018493	ISO 4028-M4x10-45H-KL	30351530
	21	DIN 7984-M6X20-10.9	12	10019671	M5 x 7	10018493	ISO 4028-M4x10-45H-KL	30351530
	22	DIN 7984-M4X16-10.9	3	10019685	M3 x 5	10025039	ISO 4028-M3x6-45H-KL	30351529
	23	DIN 7984-M4X16-10.9	3	10019685	M3 x 5	10025039	ISO 4028-M3x6-45H-KL	30351529
	24	DIN 7984-M6X20-10.9	12	10019671	M5 x 7	10018493	ISO 4028-M4x10-45H-KL	30351530
	25	DIN 7984-M6X20-10.9	12	10019671	M5 x 7	10018493	ISO 4028-M4x10-45H-KL	30351530
	26	ISO 4762-M6X25-12.9	12	10003620	M5 x 7	10018493	ISO 4028-M4x10-45H-KL	30351530
	27	ISO 4762-M6X25-12.9	12	10003620	M5 x 7	10018493	ISO 4028-M4x10-45H-KL	30351530
	28	MN685 M4x14-TX15-IP	3	30606067	M3 x 5	10025039	-	-
	29	ISO 4762-M6X25-12.9	12	10003620	M5 x 7	10018493	-	-
	30	DIN 7984-M6X20-10.9	12	10019671	M5 x 7	10018493	ISO 4028-M4x10-45H-KL	30351530
	31	DIN 7984-M4X16-10.9	3	10019685	M3 x 5	10025039	ISO 4028-M3x6-45H-KL	30351529
	32	MN685 M6x20-TX25-IP	12	30606068	M5 x 7	10018493	-	-

* Par de apriete según MN678

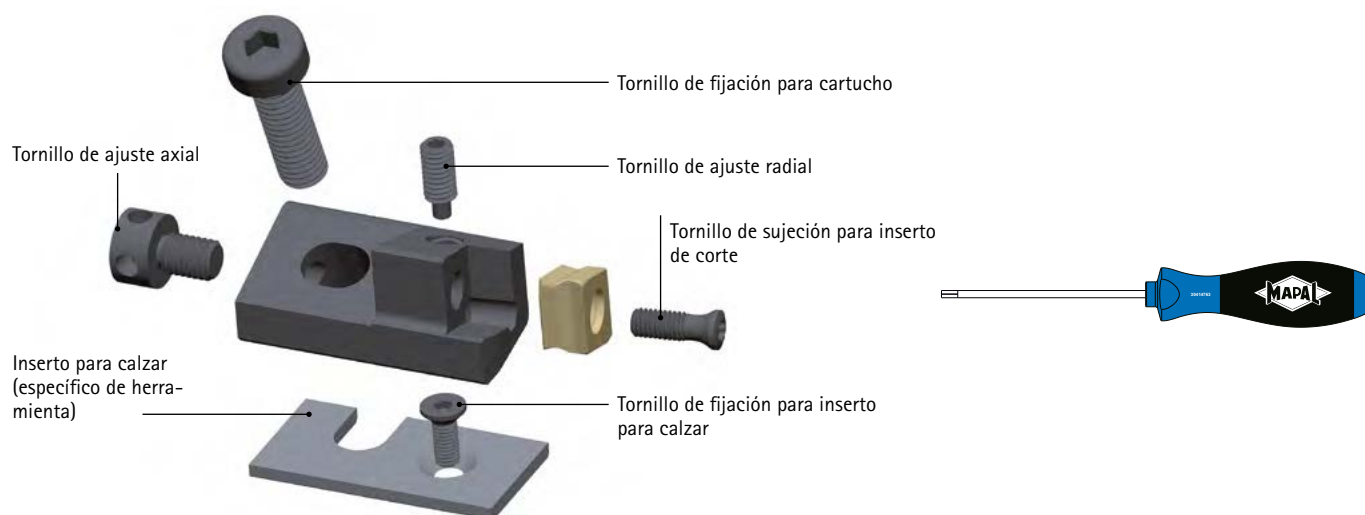

	Inserto para calzar derecha		Inserto para calzar izquierda		Tornillo de fijación para inserto para calzar		
	Denominación para pedido Inserto para calzar	Referencia	Denominación para pedido Inserto para calzar	Referencia	Denominación para pedido Tornillo de cabeza avellanada	* Par de apriete [Nm]	Referencia
	UR 12-1A	a petición	UL 12-1A	a petición	ISO 10642-M3X8-10.9	1,8	10003769
	UR 08-1A	a petición	UL 08-1A	a petición	ISO 10642-M3X6-10.9	1,8	10003768
	UR 08-1A	a petición	UL 08-1A	a petición	ISO 10642-M3X6-10.9	1,8	10003768
	UR 10-1A	a petición	UL 10-1A	a petición	ISO 10642-M3X8-10.9	1,8	10003769
	UR 10-1A	a petición	UL 10-1A	a petición	ISO 10642-M3X8-10.9	1,8	10003769
	UR 12-1A	a petición	UL 12-1A	a petición	ISO 10642-M3X8-10.9	1,8	10003769
	UR 12-1K	a petición	UL 12-1K	a petición	ISO 10642-M3X8-10.9	1,8	10003769
	UR 12-2K	a petición	UL 12-2K	a petición	ISO 10642-M3X8-10.9	1,8	10003769
	UR 06-1K	a petición	UL 06-1K	a petición	ISO 2009-M2X4-4.8	0,5	10029153
	UR 06-2K	a petición	UL 06-2K	a petición	ISO 2009-M2X4-4.8	0,5	10029153
	UR 10-1K	a petición	UL101K	a petición	ISO 10642-M3X8-10.9	1,8	10003769
	UR 12-1K	a petición	UL 12-1K	a petición	ISO 10642-M3X8-10.9	1,8	10003769
	UR 08-1K	a petición	UL 08-1K	a petición	ISO 10642-M3X6-10.9	1,8	10003768
	UR 10-1K	a petición	UL 10-1K	a petición	ISO 10642-M3X8-10.9	1,8	10003769
	UR 10-2K	a petición	UL 10-2K	a petición	ISO 10642-M3X8-10.9	1,8	10003769
	UR 10-3K	a petición	UL 10-3K	a petición	ISO 10642-M3X8-10.9	1,8	10003769
	UR 06-1K	a petición	UL 06-1K	a petición	ISO 2009-M2X4-4.8	0,5	10029153
	UR 18-1T	a petición	-	-	ISO 10642-M3X8-10.9	1,8	10003769
	UR 18-4T	a petición	-	-	ISO 10642-M3X8-10.9	1,8	10003769
	UR 14-1T	a petición	-	-	ISO 10642-M3X8-10.9	1,8	10003769
	UR 14-4T	a petición	-	-	ISO 10642-M3X8-10.9	1,8	10003769
	UR 10-1T	a petición	-	-	ISO 10642-M3X8-10.9	1,8	10003769
	UR 10-2T	a petición	-	-	ISO 10642-M3X8-10.9	1,8	10003769
	UR 14-2T	a petición	-	-	ISO 10642-M3X8-10.9	1,8	10003769
	UR 14-3T	a petición	-	-	ISO 10642-M3X8-10.9	1,8	10003769
	UR 18-2T	a petición	-	-	ISO 10642-M3X8-10.9	1,8	10003769
	UR 18-3T	a petición	-	-	ISO 10642-M3X8-10.9	1,8	10003769
	-	-	-	-	-	-	-
	-	-	-	-	-	-	-
	UR 14-5T	a petición	-	-	ISO 10642-M3X8-10.9	1,8	10003769
	UR 10-3T	a petición	-	-	ISO 10642-M3X8-10.9	1,8	10003769
	-	-	-	-	-	-	-



INSERTOS DE CORTE

Introducción

Series de material de corte	664
Vista general de los productos	666
Resumen de los materiales de corte	670
Código de denominación	676
Vista general de rompevirutas	680

Insertos de corte

Insertos de corte radiales	686
Insertos de corte tangenciales.....	708
Accesorios	730

Anexo técnico

Recomendación de valores de corte	732
---	-----

Serie de material de corte: El material de corte adecuado para cada aplicación

MAPAL ofrece una amplia gama de insertos de corte tangenciales y radiales que cubre todos los requisitos relativos a los materiales de corte y recubrimientos, así como a las geometrías de corte y precisiones correspondientes.

Serie de material de corte Performance Line

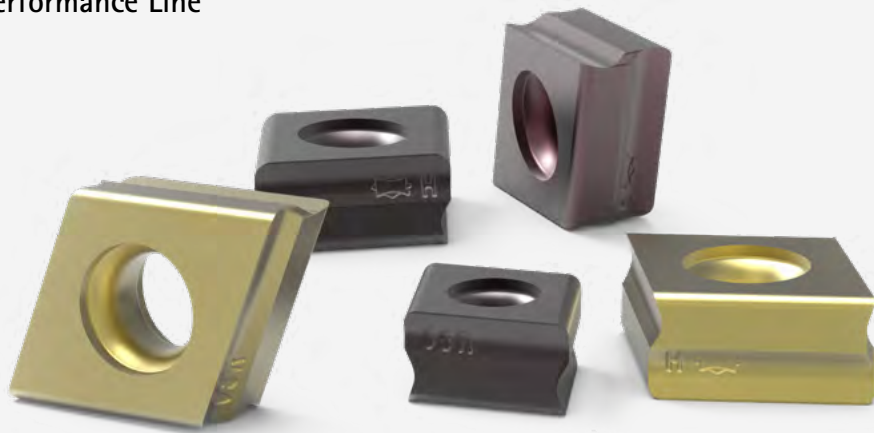

La serie de material de corte Performance Line incluye una amplia gama de insertos de corte tangenciales y radiales que cubre todos los requisitos relativos a los materiales de corte y recubrimientos, así como a las geometrías de corte y precisiones correspondientes.

Los insertos de corte afilados y de alta precisión de la clase de tolerancia H permiten un «verdadero aprovechamiento de todos los insertos» incluso con insertos fijos. Esto se debe a que, junto con los asientos de placa fabricados con precisión, los insertos solo presentan variaciones mínimas entre sí. Esto significa que todos los insertos se utilizan simultáneamente en el mecanizado. Como resultado, es posible aumentar considerablemente el rendimiento.

Los insertos de corte tangenciales y radiales sinterizados de la clase de tolerancia M amplían el programa con unas alternativas especialmente económicas, en particular para mecanizados con mayores tolerancias admisibles. Una novedad en el programa son los insertos radiales y tangenciales afilados en todo el entorno de la clase de tolerancia G, que representan una alternativa rentable a los insertos de alta precisión.

RESUMEN

- Amplia oferta de insertos de corte tangenciales y radiales
- La oferta abarca desde insertos de corte afilados de alta precisión en la clase de tolerancia H hasta insertos de corte sinterizados en la clase de tolerancia N y G
- Gran selección de materiales de corte para casi todos los ámbitos de uso
- Variantes equipadas con PCD y PcBN para el mecanizado altamente rentable de aluminio o fundición

Identificación de insertos de corte prensados «press-to-size»



Serie de material de corte Basic Line

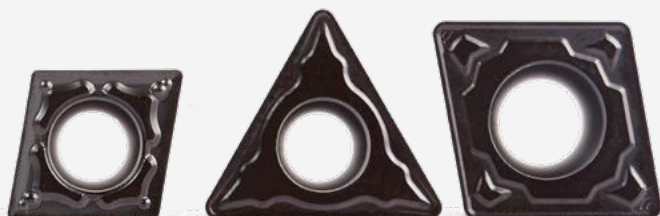

El nuevo programa Basic Line de insertos radiales positivos para el mandrinado y torneado convence por una excelente relación precio-rendimiento. Para el mecanizado de hierro fundido, acero y acero inoxidable se dispone de materiales de corte con recubrimiento de PVD y CVD, que cubren un amplio rango de resistencia al desgaste y tenacidad. De este modo puede seleccionarse el inserto de corte óptimo para cada aplicación. En función del mecanizado están disponibles diferentes formas básicas con tres rompevirutas diferentes para el desbaste, para el mecanizado medio y para el acabado.

RESUMEN

- Filos radiales positivos para el mandrinado y torneado
- Excelente relación precio-rendimiento
- Materiales de corte con recubrimiento de PVD y CVD para materiales P, M y K
- Insertos de cermet para una alta calidad de superficie en acero
- Diferentes rompevirutas para el desbaste, el mecanizado medio y el acabado

Serie de material de corte para el mecanizado mixto



Las combinaciones de materiales de aluminio y acero sinterizado o de aluminio y fundición, como las utilizadas en la producción del cárter, plantean exigencias especiales de mecanizado. MAPAL ofrece una serie de materiales de corte especialmente adaptados para este tipo de mecanizado. Tanto sus sustratos de metal duro como las microgeometrías y macrogeometrías de los insertos han sido especialmente desarrollados para el mecanizado mixto.









Un recubrimiento de PVD como parte de la serie de material de corte evita tanto un recrecimiento del filo durante el mecanizado del aluminio como un desgaste excesivo durante el mecanizado de la parte de hierro fundido o acero sinterizado de la pieza. Esto se debe a que garantiza que el material de corte sea especialmente resistente al desgaste y al calor. De este modo, el mecanizado puede llevarse a cabo con la máxima calidad.

RESUMEN

- Material de corte para el mecanizado de las combinaciones de material aluminio/fundición y aluminio/acero sinterizado
- Sustratos de metal duro adaptados, microgeometrías y macrogeometrías optimizadas del inserto, recubrimiento de PVD basado en una aleación de TiAlN con elemento dopante especial
- Insertos de corte ISO estándar y especiales disponibles
- Larga vida útil y alta rentabilidad

Visión general de los productos: insertos de corte 1/2

Tecnología radial

Tipo de inserto	Tecnología radial – Basic Line							
	CCMT	CCGT	DCMT	SCMT SPMT	SCGT	TCMT	VCMT	VCGT
								

Características

Número de filos de corte	2	2	2	4	4	3	2	2
Tamaño de inserto	06 / 09 / 12	06 / 09 / 12	07 / 11 / 15	06 / 09 / 12	09	09 / 11 / 16 / 22	16	11
Rango de diámetros	desde 17 mm	desde 17 mm		desde 17 mm	desde 25 mm	desde 17 mm		
Dirección de corte	N	N	N	N	N	N	N	N
Mandrinado – neutro	■	■	■	■	■	■	■	■
Mandrinado – afilado con forma de arco								
Avellanado/biselado								

Uso

Desbaste	■		■	■		■	■	
Mecanizado medio	■	■	■	■		■	■	■
Acabado	■	■	■	■	■	■		

Material de corte

Metal duro – afilado		■						■
Metal duro – prensado	■		■	■		■	■	
Cermet		■	■		■	■	■	
PcBN								
PCD								







Idoneidad del material

P	■	■	■	■	■	■	■	■
M ₁	■	■	■	■		■		■
M ₂	■	■	■	■		■		■
K	■		■	■		■	■	
N								
N K								
N P								

Página	686	688	692	694	694	700	704	704
--------	-----	-----	-----	-----	-----	-----	-----	-----

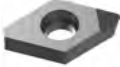
Visión general de los productos: insertos de corte 2/2

Tecnología tangencial

Tipo de inserto	Tecnología radial – Performance Line							
	CCGT	CCGW	DCGT	DCGW	SCGT SPGT	SCGW SPGW	TCGW	VBGW VCGW
								

Características

Número de filos de corte	1	1	1	1	1	1	1	1
Tamaño de inserto	06 / 09	06 / 09	11	11	06 / 09	06 / 09 / 12	11	16
Rango de diámetros	desde 17 mm	desde 17 mm			desde 17 mm	desde 17 mm	desde 17 mm	
Dirección de corte	N	N	N	N	L / R / N	N	N	N
Mandrinado – neutro	■	■	■	■	■	■	■	■
Mandrinado – afilado con forma de arco								
Avellanado/biselado								

Uso

Desbaste								
Mecanizado medio	■	■	■			■	■	
Acabado	■	■	■	■	■	■	■	■









Material de corte

Metal duro – afilado								
Metal duro – prensado								
Cermet								
PcBN		■		■		■	■	■
PCD	■	■	■	■	■	■	■	

Idoneidad del material

P								
M ₁								
M ₂								
K		■		■		■	■	■
N	■	■	■	■	■	■	■	
N K								
N P								

Página	688	689	692	692	694	696	700	704
--------	-----	-----	-----	-----	-----	-----	-----	-----

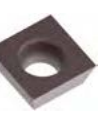
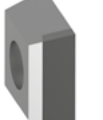
Tecnología tangencial – Performance Line									
CTNQ	CTGQ	CTHQ		FTNQ	FTGQ	FTHQ		STHD / STHE	
									
4	4	4	1	4	4	4	1	4	1
09 / 12	09 / 12	06 / 09 / 12	06 / 09 / 12	09 / 12	09 / 12	06 / 09 / 12	06 / 09 / 12	06 / 09	06 / 09
desde 41 mm	desde 65 mm	desde 28 mm	desde 28 mm	desde 30 mm	desde 30 mm	desde 22 mm	desde 22 mm		
L / R	L	L / R	L / R	L / R	L	L / R	L / R	N	N
■		■	■	■		■	■		
	■	■	■		■	■	■		
								■	■
■	■	■	■	■	■	■	■		
■	■	■	■	■	■	■	■		
■		■			■	■		■	
	■			■					
			■				■		■
■	■	■		■	■	■			
■	■	■		■		■			
■	■	■		■		■		■	
■		■		■	■	■		■	
		■	■			■	■	■	■
708	710	712	712	718	720	722	722	728	728

Resumen de los materiales de corte: Selección del material de corte correcto

Selección de un material de corte

Los materiales de corte cubren un amplio rango de resistencia al desgaste y tenacidad. La denominación del material de corte está formada de tal modo que la tenacidad aumenta con el número.

Los materiales de corte con recubrimiento de CVD (HC...) son la mejor opción para el mandrinado de materiales K, P y M. Consiguen la mayor vida útil.

Ejemplo: HC830 es más tenaz que HC815 (cuanto más tenaz un material de corte, menor la resistencia al desgaste).

Para los materiales no ferrosos, las clases de metal duro sin recubrimiento y con recubrimiento de PCD (HU.../HP...) son la primera elección. A partir de un contenido de silicio de $\geq 12\%$, se recomienda PCD (PU...) debido a su creciente abrasividad. Con PCD se logra la vida útil más duradera. Por eso, este material de corte es idóneo especialmente para series grandes.

1. Seleccione el material según el grupo de arranque de virutas Mapal (para los grupos de material a mecanizar MAPAL, véase la página desplegable de la cubierta).

2. Seleccione en la **tabla «Resumen de los materiales de corte [...]»** la clase que se encuentra debajo del material deseado según la línea de producto.

3. En función de las condiciones marco (véase la **tabla «Condiciones marco»**) deberá seleccionarse un material de corte con recubrimiento CVD con mayor resistencia al desgaste o mayor tenacidad.

4. Si predominan las condiciones marco en dirección de las flechas negras y si no pueden impedirse roturas a pesar de una clase CVD tenaz, es recomendable cambiar a los materiales de corte con recubrimiento de PVD.

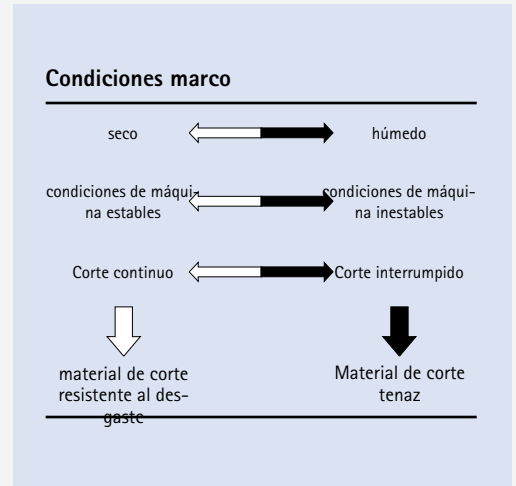

Resumen de los materiales de corte Basic Line

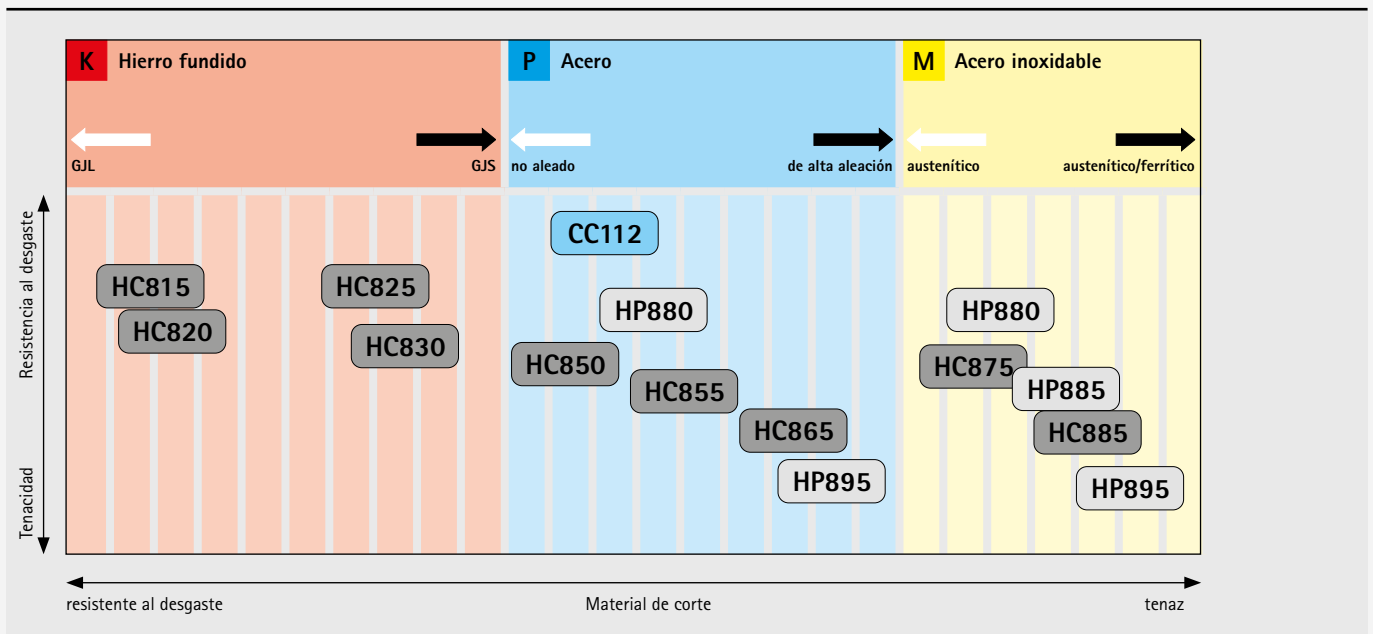

- CVD
- PVD
- Cermet, CVD

Selección de un material de corte

1. Seleccione en la tabla «Resumen de los materiales de corte» la clase que se encuentra debajo del material deseado.
2. Para el mecanizado mixto de aluminio/hierro fundido, la clase HP530-P es la mejor opción, y para aluminio/acero, la clase HP545-P.
3. Si está garantizado un proceso estable con un desgaste normal, para una vida útil más larga podrá seleccionarse una clase más resistente al desgaste: HP525-P para aluminio/hierro fundido o HP540-P para aluminio/acero.

Resumen de los materiales de corte para el mecanizado mixto

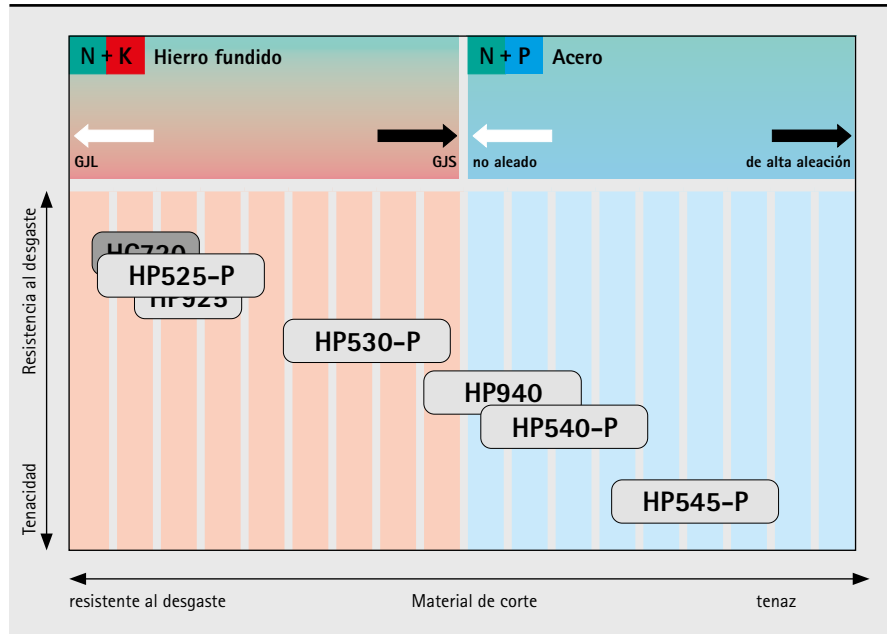

Pulido de PVD

Resumen de los materiales de corte Performance Line

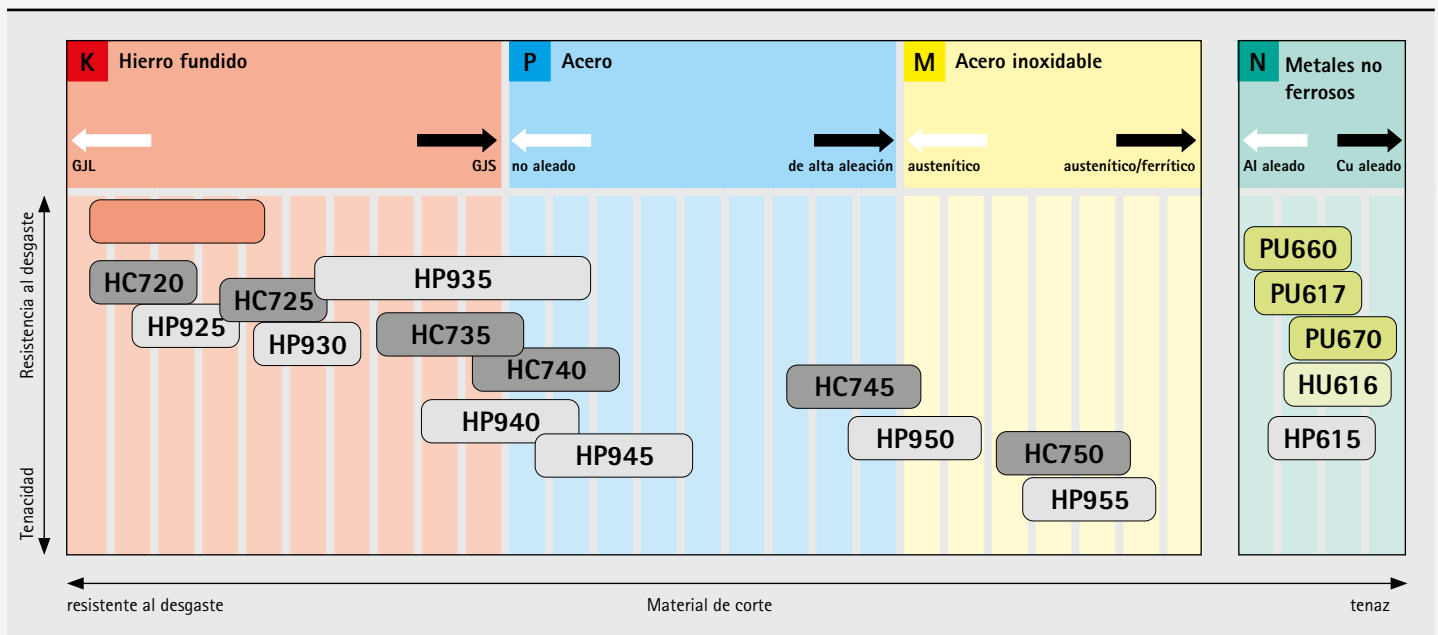

- CVD
- PVD
- PcBN
- PCD
- sin revestir

Resumen de los materiales de corte: Clases y descripción de las clases 1/2

Sustrato	Recubrimiento	Material de corte	Composición de capa	Color de capa	Ámbito de uso	Aplicación recomendada
Cermet	con recubrimiento de CVD	CC112	TiCN+Al ₂ O ₃	Varios colores		Clase de cermet de grano muy fino con recubrimiento de Al ₂ O ₃ para el acabado y el semimecanizado de acero y materiales de hierro fundido a velocidades de corte elevadas.
PcBN	sin revestir	FU430	-	-		Clase PcBN con alto contenido de CBN para el acabado y semiacabado de GJL y metal sinterizado.
Metal duro	con recubrimiento de CVD	HC698*	Diamante	Negro antracita		Metal duro con un recubrimiento de diamante CVD para el mecanizado de aluminio.
		HC725	TiCN+Al ₂ O ₃	Negro		Metal duro de grano fino con gran resistencia al desgaste y un recubrimiento CVD de varias capas con capa de cobertura de Al ₂ O ₃ para el mecanizado de GJL y GJS a velocidades de corte elevadas. Para un corte liso hasta ligeramente interrumpido para el mecanizado intermedio y el mecanizado de desbaste.
		HC740	TiCN+Al ₂ O ₃	Negro		Metal duro de grano fino con gran resistencia al desgaste y un recubrimiento CVD de varias capas con capa de cobertura de Al ₂ O ₃ . Para un corte liso hasta ligeramente interrumpido para el mecanizado intermedio y el mecanizado de desbaste, aceros de baja aleación, así como fundición de acero resistente al calor.
		HC745	TiCN+Al ₂ O ₃	Negro		Metal duro de grano fino con una relación equilibrada entre desgaste y tenacidad, y un recubrimiento CVD de varias capas con capa de cobertura de Al ₂ O ₃ para el mecanizado a velocidades de corte más elevadas. Para el corte continuo o las relaciones y materiales inestables con gran resistencia a la tracción y aceros de alta aleación a inoxidables, así como fundición de acero resistente al calor.
		HC750	TiCN+Al ₂ O ₃	Negro		Metal duro de grano fino con una relación equilibrada de la tenacidad, y un recubrimiento CVD de varias capas con capa de cobertura de Al ₂ O ₃ . Para el corte continuo las relaciones y materiales inestables con mayor resistencia a la tracción, desde aceros inoxidables hasta fundiciones de acero resistentes al calor.
		HC815	TiCN+Al ₂ O ₃	Negro		Clase de metal duro de grano fino resistente al desgaste con recubrimiento de Al ₂ O ₃ . Adecuado para el mecanizado de materiales de hierro fundido en condiciones estables.
		HC820	TiCN+Al ₂ O ₃	Negro		Metal duro con recubrimiento de Al ₂ O ₃ con tratamiento posterior optimizado para incrementar la estabilidad de bordes. Adecuado para el mecanizado de GJL en condiciones estables y corte ligeramente interrumpido.
		HC825	TiCN+Al ₂ O ₃	Negro		Resistencia al desgaste incrementada debido al recubrimiento CVD grueso. Adecuado para el mecanizado de fundición en condiciones inestables.
		HC830	TiCN+Al ₂ O ₃	Negro		Clase de metal duro de grano fino con recubrimiento grueso y estabilidad de bordes mejorada. Adecuado para corte fuertemente interrumpido en fundición.
		HC850	TiCN+Al ₂ O ₃ +TiN	Dorado		Metal duro de gradiente con recubrimiento de MT-TiCN y Al ₂ O ₃ y capa superior de TiN. Adecuado para el mecanizado de acero debido a la rugosidad superficial reducida.
		HC855	TiCN+Al ₂ O ₃ +TiN	Dorado		Metal duro de gradiente con relación equilibrada de tenacidad y resistencia al desgaste. Adecuado para el semiacabado y el mecanizado medio de acero.
		HC865	TiCN+Al ₂ O ₃ +TiN	Dorado		Clase de metal duro de gradiente tenaz con recubrimiento de Al ₂ O ₃ y capa superior lisa de TiN. Adecuado para el semiacabado y el mecanizado medio de acero y acero aleado.
		HC875	TiCN+Al ₂ O ₃ +TiN	Dorado		Clase de metal duro de gradiente de grano fino con recubrimiento CVD fino. Adecuado para el mecanizado de acero de alta aleación y acero inoxidable.
		HC885	TiCN+Al ₂ O ₃ +TiN	Dorado		Clase de metal duro con tenacidad incrementada y recubrimiento CVD. Adecuado para el mecanizado de acero inoxidable.

* Material de corte para el barrenado en sólido de aluminio.







Resumen de los materiales de corte: Clases y descripción de las clases 2/2

Sustrato	Recubrimiento	Material de corte	Composición de capa	Color de capa	Ámbito de uso	Aplicación recomendada	
Metal duro	con recubrimiento de PVD	HP615	TiB2	Antracita	●	Metal duro de granulado fino con una capa de PVD parcialmente reducida para mecanizar materiales adhesivos. Primera opción para prolongar la duración respecto a los insertos sin recubrimiento en aleaciones de aluminio con un 7-12 % de silicio.	
		HP880	TiAlN	Antracita	●	Excelente resistencia al desgaste y resistencia al calor, debido al nuevo recubrimiento de PVD. Adecuado para el acabado de acero inoxidable.	
		HP885	TiAlN + TiAlSiN	Cobre	●	Material de corte resistente a la temperatura, metal duro de grano muy fino con recubrimiento de PVD multicapa para el mecanizado universal de aceros inoxidables.	
		HP895	TiAlN	Antracita	⚡	Metal duro de granulado muy fino con recubrimiento de TiAlN, con alto contenido de agente adhesivo. Combinación optimizada de resistencia al desgaste y tenacidad. Adecuado para el semiacabado de acero inoxidable.	
		HP930	AlTiCrN	Negro antracita	●	Metal duro de grano fino con capa gruesa de PVD. Clase para el semimecanizado y mecanizado de desbaste, para el mecanizado de GJL y GJS.	
		HP945	AlTiCrN	Negro antracita	⚡	Metal duro de grano fino con capa gruesa de PVD. Para el mandrinado de aceros y aceros inoxidables, así como fundición de acero resistente al calor.	
		HP950	TiAlSiN	Cobre	⚡	Metal duro de granulado muy fino, tenaz, con capa de PVD. Para el mandrinado de materiales de máxima resistencia a la tracción, aceros inoxidables y fundiciones de acero resistentes al calor.	
	Con recubrimiento de PVD, mecanizado mixto	HP525-P	TiAlXN	Dorado-marrón	●	Metal duro con recubrimiento de PVD, especialmente adecuado para el mecanizado mixto de aluminio y GJL/GJS con corte liso.	
		HP530-P	TiAlXN	Dorado-marrón	●	Metal duro con recubrimiento de PVD, especialmente adecuado para el mecanizado mixto de aluminio y GJL/GJS con corte desde liso hasta ligeramente interrumpido.	
		HP540-P	TiAlXN	Dorado-marrón	●	Metal duro con recubrimiento de PVD, especialmente adecuado para el mecanizado mixto de aluminio y acero sinterizado con corte desde liso hasta ligeramente interrumpido.	
		HP545-P	TiAlXN	Dorado-marrón	●	Metal duro con recubrimiento de PVD, con una relación equilibrada de la tenacidad, especialmente adecuado para el mecanizado mixto de aluminio y acero sinterizado con corte desde ligeramente hasta fuertemente interrumpido.	
	PCD	I	PU617	-	-	●	Clase PCD con granulometría media para el mecanizado de desbaste y semimecanizado en metales no ferrosos y para el mecanizado de materiales muy abrasivos.
			PU660	-	-	●	Clase PCD de grano fino para el acabado de metales no ferrosos y materiales no metálicos, como por ejemplo plásticos reforzados con fibras. El grano fino dota al inserto de unas buenas propiedades de afilado con una buena resistencia al desgaste para conseguir unos acabados superficiales elevados.
PU670			-	-	⚡	Material de corte de PCD con granulometría media y gruesa. Excelente resistencia al desgaste mecánico con buena tenacidad, especialmente adecuado para el mecanizado de materiales abrasivos.	



Código de denominación: insertos de corte radiales

S
C
H
T
0
9
T
3

Forma de inserto

S (90°)

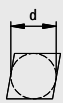
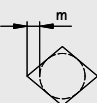
C (80°)

T (60°)

D (55°)

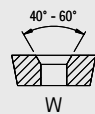
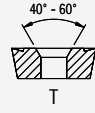
V (35°)

W (82°) **





Tolerancia

			
	d [mm]	m [mm]	s [mm]
H	±0,013	±0,013	±0,025
G	±0,025	±0,025	desde ±0,05 hasta ±0,13 *
M	desde ±0,05 hasta ±0,15 *	desde ±0,08 hasta ±0,20*	desde ±0,05 hasta ±0,13 *

Tipo de inserto

 W
 T

Tamaño de inserto

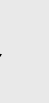
Circunferencia inscrita					
d [mm]	S	C	T	D	V
5,56	-	-	09	-	-
6,35	06	06	11	07	11
6,70	-	-	-	-	-
9,525	09	09	16	11	16
12,70	12	12	22	-	-

Ángulo de incidencia

	
B	5°
C	7°
P	11°
O	Forma especial

Grosor de inserto

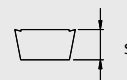
	
Indicador	s [mm]
T1	1,98
02	2,38
03	3,18
T3	3,97
04	4,76

* Tolerancia en función del tamaño de inserto

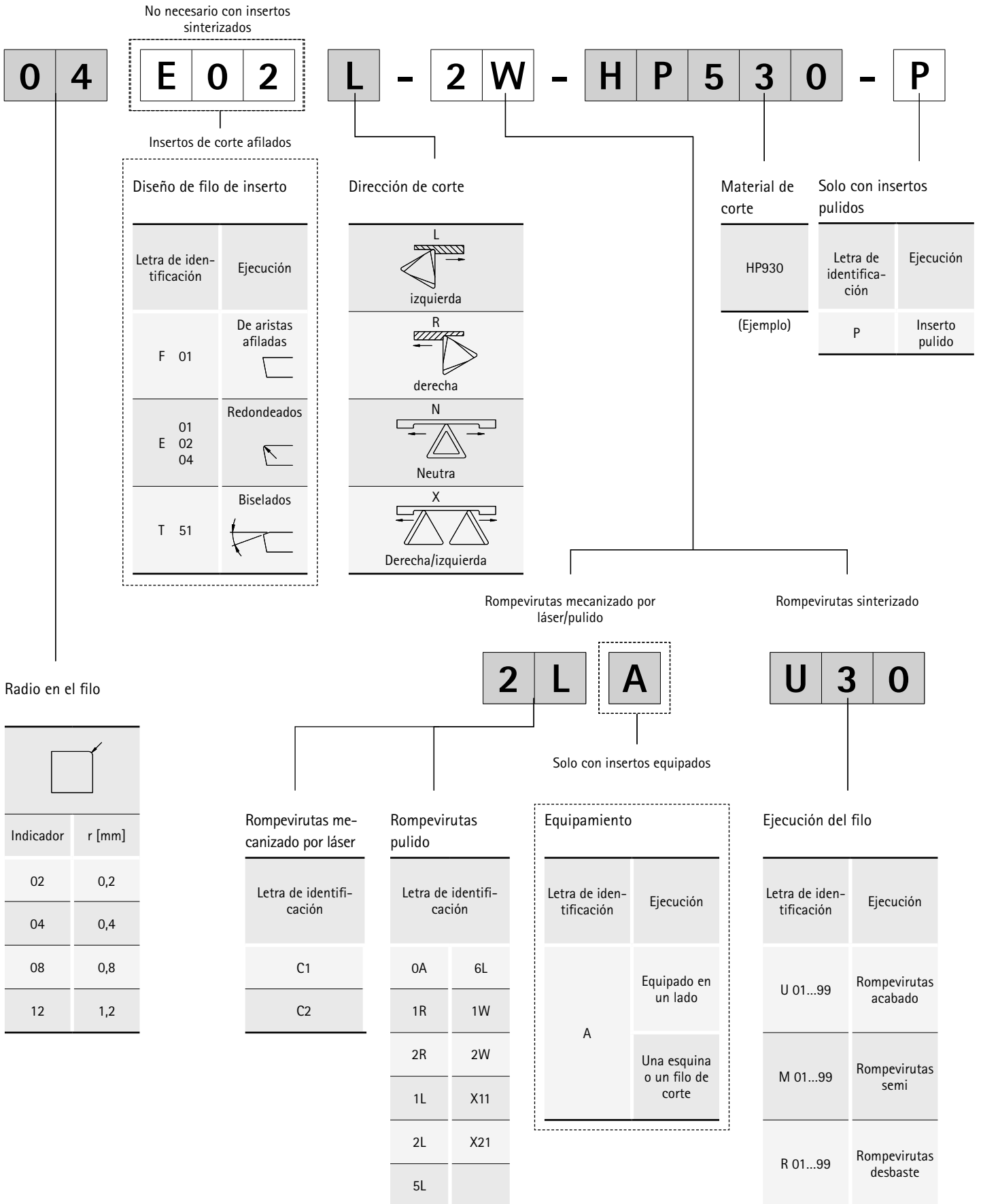

** Barrenado en sólido





Código de denominación: insertos de corte tangenciales

C
T
H
Q
09
05
08





Forma de inserto

C (80°) 
F (70°) 
S (90°) 

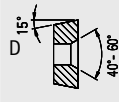

Tolerancia

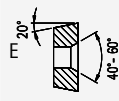
	 d [mm]	 s [mm]
H	±0,013	±0,025
G	±0,025	±0,13
N	±0,05 - ±0,15	±0,025

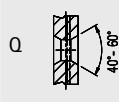
Tipo de inserto







Tamaño de inserto

Circunferencia inscrita	 d	 d1	 d
	d [mm]	C	F
6,35	06/09	06	06
9,525	09/13	09	09
12,7	12/18	12	-





Inserto de corte

T
Tangencial

Grosor de inserto

	Indica- dor	s [mm]
	03	3,18
	T3	3,97
	04	4,76
	05	5,56
	06	6,35

Radio en el filo

	Indicador	r [mm]
	00	0
	04	0,4
	08	0,8
	12	1,2

H 0 2

L

0 0

B 0 4 1

- H P 9 4 5

Dirección de corte

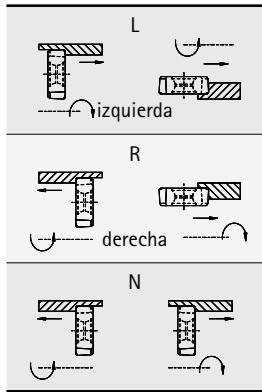

Ángulo de incisión

Mandrinado

Afilado con forma de arco

Indicador	Ángulo
00	0°
10	10°

Material de corte

HP950

(Ejemplo)

Rompe virutas







Letra de identificación
A 01...99
D 01...99
G 01...99
H 01...99

Afilado con forma de arco

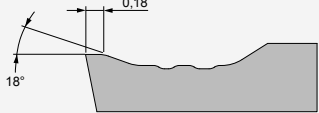
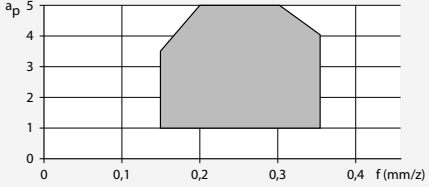
Afilado con forma de arco			
	Indicador	Radio	
Posición de montaje	B012	12	CTHQ/FTHQ
	B016	16	
	B021	21	
	B041	40	
	B081	80	

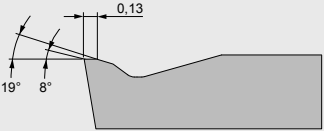
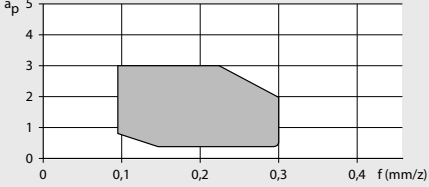
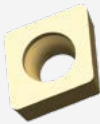
Visión general de rompevirutas – Mandrinado

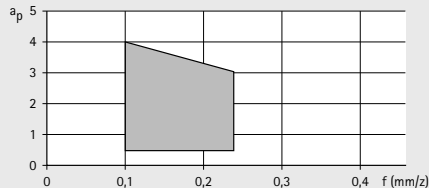
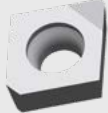
Insertos de corte reversibles radiales

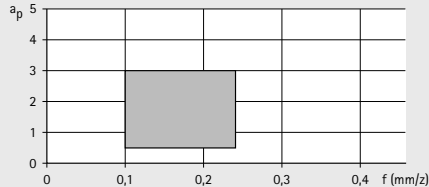



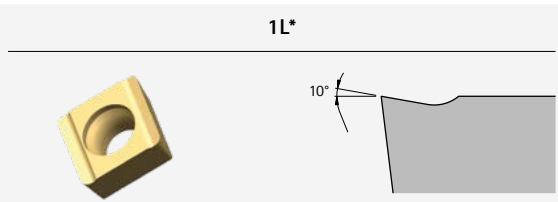
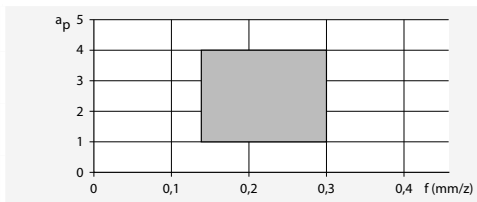
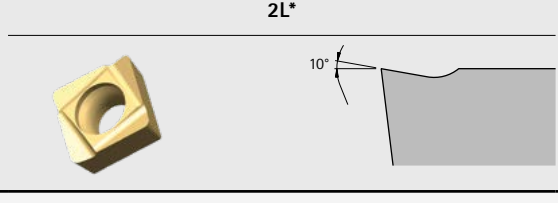
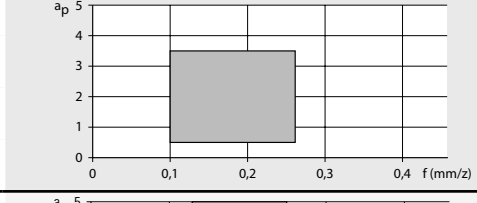
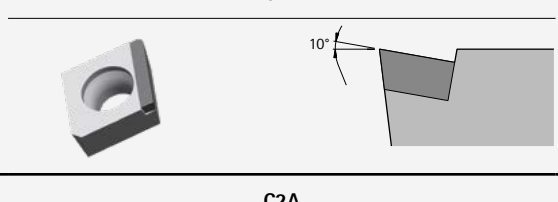
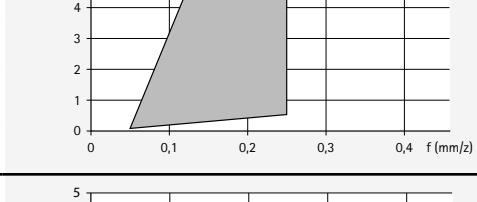
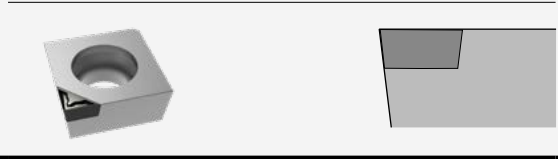
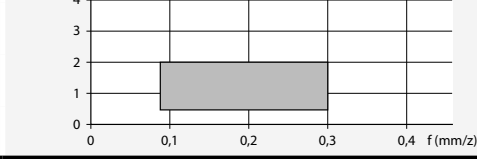
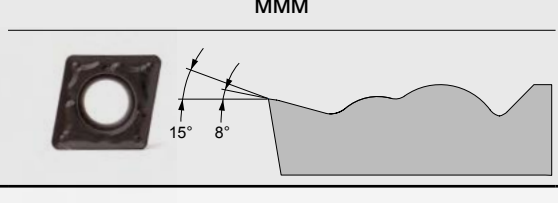
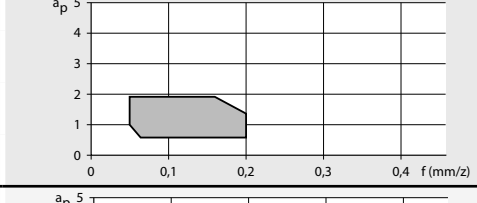
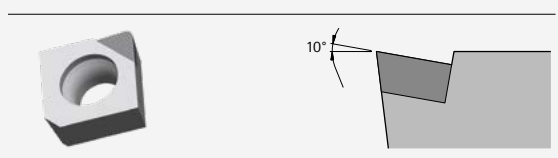
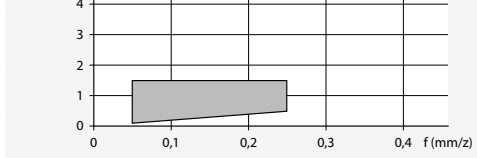
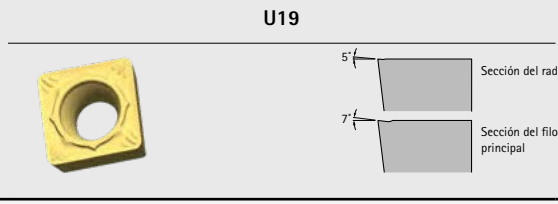
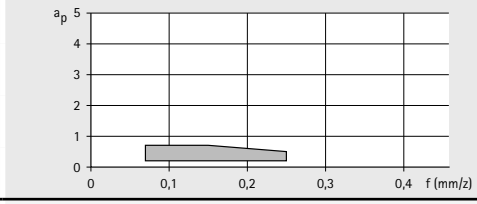
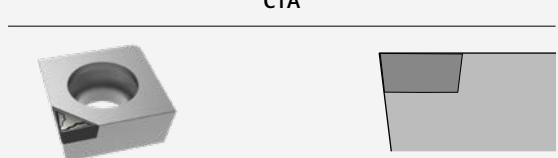
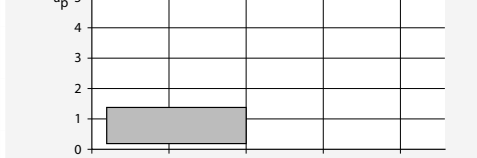



	Tipo	Grupo de materiales	Preparación del filo	Diagrama
Desbaste	MKM  	P M K N	+++	
	MGP  	P M K N	++	
Mecanizado medio	OA*  	P M K N	+ ++	
	OAA*  	P M K N	0 + ++	

* Este rompevirutas está disponible con diferentes preparaciones del filo.
 0 = de aristas afiladas | + = ligeramente redondeado | ++ = redondeo intermedio | +++ = redondeo alto

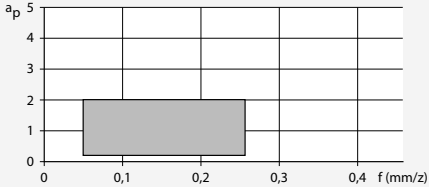
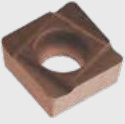
	Tipo	Grupo de materiales	Preparación del filo	Diagrama
Mecanizado medio	1L* 	P M K N	+ ++	
	2L* 	P M K N	+ ++	
	6LA 	P M K N	0	
	C2A 	P M K N	0	
Acabado	MMM 	P M K N	++	
	5LA 	P M K N	0	
	U19 	P M K N	+	
	C1A 	P M K N	0	

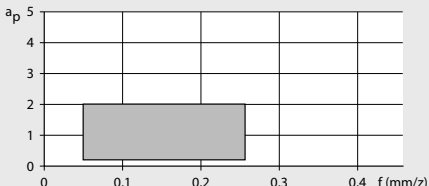
Visión general de rompevirutas – Mandrinado

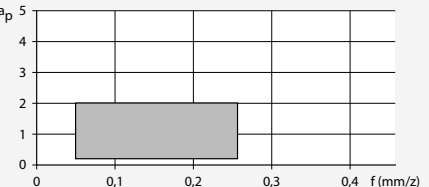
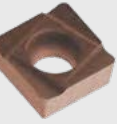
Insertos de corte reversibles radiales

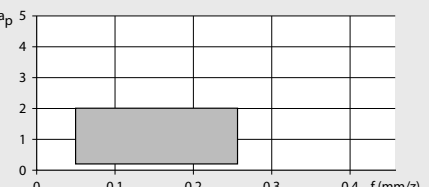
	Tipo	Grupo de materiales	Preparación del filo	Diagrama
Mecanizado mixto	1R*  	P M K N	0 +	
	2R*  	P M K N	0 +	
	1W  	P M K N	+	
	2W  	P M K N	+	

Identificación de insertos de corte prensados «press-to-size»



* Este rompevirutas está disponible con diferentes preparaciones del filo.
 0 = de aristas afiladas | + = ligeramente redondeado | ++ = redondeo intermedio | +++ = redondeo alto

Notas

Visión general de rompevirutas – Mandrinado

Insertos de corte reversibles tangenciales

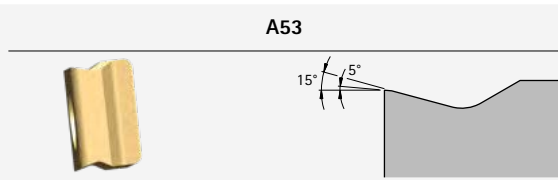
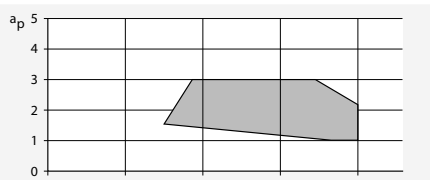
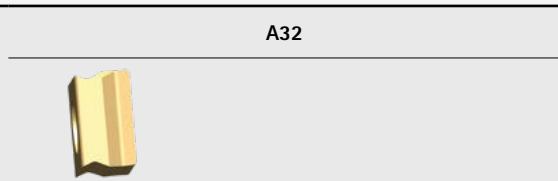
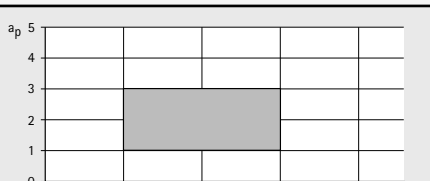
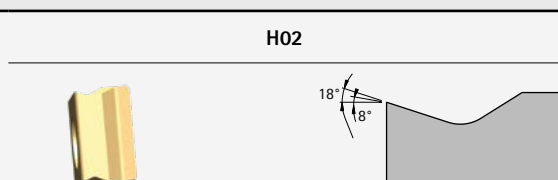
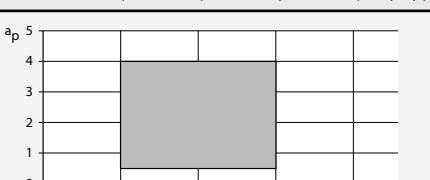
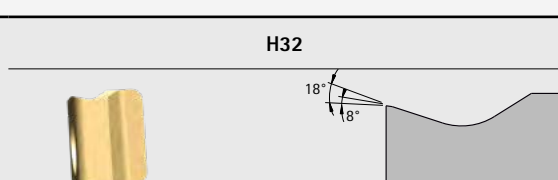
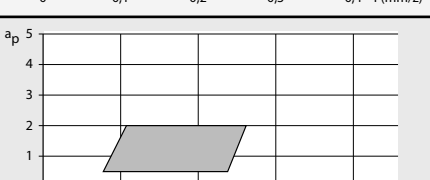
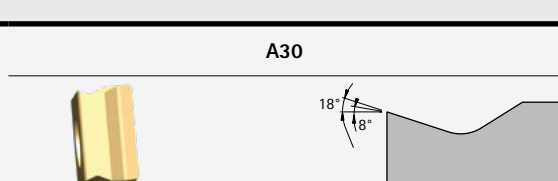
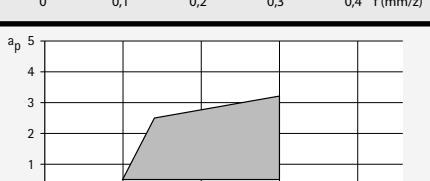
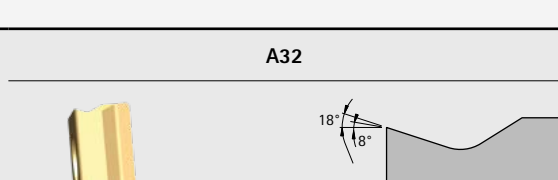
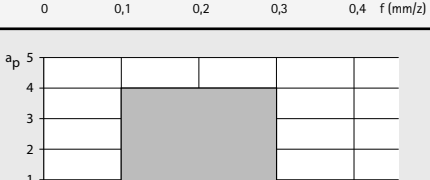
	Tipo	Grupo de materiales	Preparación del filo	Diagrama
Desbaste	A53 	P M K N	++	
	A32 	P M K N	++	
	H02 	P M K N	++	
	H32 	P M K K	++	
Mecanizado medio	A30 	P M K N	0	
	A32 	P M K N	++	

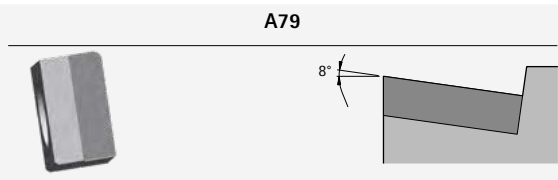
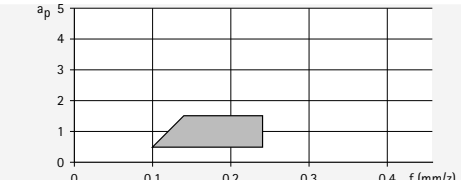
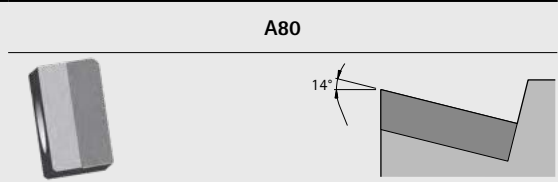
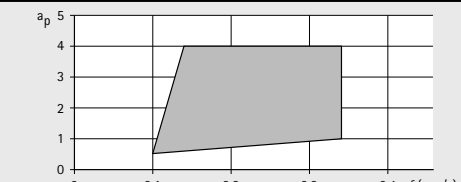
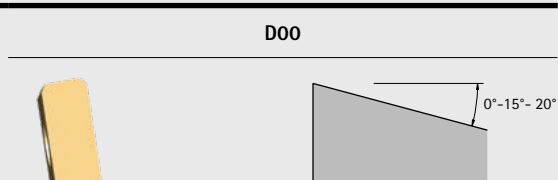
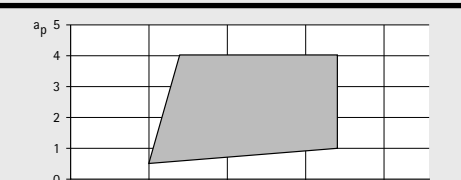
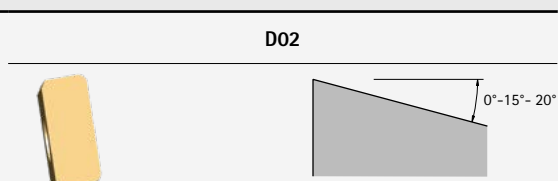
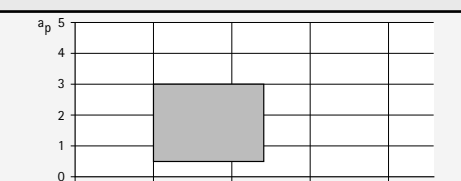
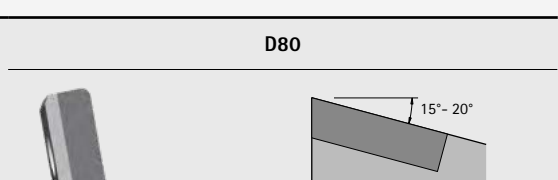
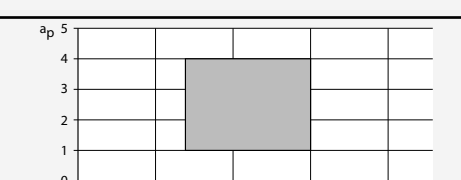
	Tipo	Grupo de materiales	Preparación del filo	Diagrama
Mecanizado medio	A79 	P M K N	0	
	A80 	P M K N	0	
Universal	D00 	P M K N	0	
	D02 	P M K N	++	
	D80 	P M K N	0	

CCMT

Inserto de corte radial,
de doble filo, ejecución neutra



Material	P						
	no aleado resistente al desgaste	aleado tenaz	no aleado resistente al desgaste	aleado tenaz			
Sustrato	Metal duro						
Recubrimiento	CVD			PVD			
Clase de materiales de corte	HC850	HC855	HC865	HP880	HP895		
Diseño de filo de inserto	MKM		MKM				
CCMT06 a_p máx. [mm]							
Desbaste	CCMT060204N-...-	1,5 - 2,5					
	CCMT09						
	CCMT09T304N-...-	1,5 - 3,0		30966062			
		1,5 - 4,0					
	CCMT09T308N-...-	1,5 - 3,0	31265843	30985462			
		1,5 - 4,0					
	CCMT12						
	CCMT120408N-...-	1,5 - 4,0	31265844	30985477			
		1,5 - 5,0					
	CCMT120412N-...-	1,5 - 4,0	31265846	30985485			
	1,5 - 5,0						
Diseño de filo de inserto	MGP	MGP	MGP	MGP	MGP		
CCMT06 a_p máx. [mm]							
Mecanizado medio	CCMT060202N-...-...	0,25 - 2,0					
	CCMT060204N-...-...	0,5 - 2,0		30985423	30985422		
	CCMT060208N-...-...	0,75 - 2,0	30985443		30985442		
	CCMT09						
	CCMT09T302N-...-...	0,25 - 3,0	30985451				
	CCMT09T304N-...-...	0,5 - 3,0		30985455	31092654	30966057	30966058
	CCMT09T308N-...-...	0,75 - 3,0	31265842	30985892	30985461	30985891	30985460
	CCMT12						
	CCMT120404N-...-...	0,5 - 3,0	30985470				
	CCMT120408N-...-...	0,75 - 3,0	30985473		30985474		
CCMT120412N-...-...	1,0 - 3,0	31265845		31092655			
Diseño de filo de inserto	MMM		MMM	MMM	MMM		
CCMT06 a_p máx. [mm]							
Acabado	CCMT060202N-...-...	0,5 - 1,0	30985415			30985414	
	CCMT060204N-...-...	0,5 - 1,0	30985435		30985436	30985432	30985433
	CCMT060208N-...-...	0,5 - 1,0					30985448
	CCMT09						
	CCMT09T302N-...-...	0,5 - 1,0	30985453				30985452
	CCMT09T304N-...-...	0,5 - 1,0	30985887		30966053	30966070	30955706
	CCMT09T308N-...-...	0,5 - 1,0	30985465		30985896	30985894	30985895

M					K		
austenítico ← resistente al desgaste		ferrítico → tenaz	austenítico ← resistente al desgaste	ferrítico → tenaz	GJL ← resistente al desgaste		GJS → tenaz
Metal duro					Metal duro		
CVD		PVD			CVD		
HC875	HC885	HP880	HP885	HP895	HC820	HC830	
					MKM	MKM	
					30985425	30985427	
					30966120	30985884	
					30966113	30985893	
					30985475	30985476	
					30985481	30985483	
	MGP	MGP	MGP	MGP	MGP	MGP	
	30985420	30985421		31245556	30985422	30985413	30985419
				31245557	30985442	30985439	30985441
						30985450	
	30985883	30966056	30966057	31245558	30966058	30985882	30985454
	30985459	30985890	30985891	31245559	30985460	30985888	30985889
						30985467	30985469
	30985899					30985472	30985898
						30985479	
			MMM	MMM	MMM	MMM	MMM
					30985414		
			30985432	31245539	30985433	30985429	30985431
				31245541	30985448	30985445	30985447
					30985452		
			30966070	31245543	30955706	30985885	30985886
			30985894	31245545	30985895	30985463	30985464

CCGT

Inserto de corte radial, de doble filo, ejecución neutra



Metal duro/cermet

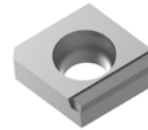

6LA

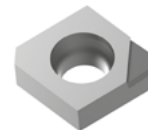

5LA



C1A



C2A

Variantes equipadas,
de un filo:

Material	P		M	N		
				Al aleado resistente al desgaste		
Sustrato	Cermet	Metal duro	Metal duro	PCD		
Recubrimiento	CVD	PVD	PVD	-		
Clase de materiales de corte	CC112	HP895	HP895	PU617	PU660	PU670

Diseño de filo de inserto	a_p máx. [mm]	MGP		6LA	C2A	
CCGT06						
CCGT060202N-...-...	0,25 - 2,0		30985376	30985376		
CCGT060204F01L-...-...	0,1 - 3,0			30708850		
CCGT060204F01R-...-...	0,1 - 3,0			31277722		
CCGT060204N-...-...	0,5 - 2,0		30985378	30985378		
CCGT060208F01L-...-...	0,1 - 3,0			30375239		
CCGT060208F01R-...-...	0,1 - 3,0			31204099		
CCGT060208N-...-...	0,75 - 2,0		30985393	30985393		
CCGT09						
CCGT09T302N-...-...	0,25 - 3,0		30985398	30985398		
CCGT09T304F01L-...-...	0,1 - 4,5			30370125		
CCGT09T304F01R-...-...	0,1 - 4,5			30497774		
CCGT09T304F01N-...-...	0,4 - 1,6					30234061
CCGT09T304N-...-...	0,5 - 3,0		30985400	30985400		
CCGT09T308F01L-...-...	0,1 - 4,5			30370124		
CCGT09T308F01R-...-...	0,1 - 4,5			30370397		
CCGT09T308F01N-...-...	0,5 - 2,0					30234062
CCGT09T308N-...-...	0,75 - 3,0		30985406	30985406		
CCGT12						
CCGT120404N-...-...	0,5 - 3,0		30985410	30985410		
CCGT120404F01L-...-...	0,1 - 7,0			31025433		
CCGT120408N-...-...	0,5 - 3,0		30985411	30985411		
CCGT120408F01L-...-...	0,1 - 7,0			30589862		

Diseño de filo de inserto	a_p máx. [mm]	U19		5LA	C1A	
CCGT06						
CCGT060204N-...-...	0,1 - 0,5	30874908				
CCGT060204F01N-...-...	0,1 - 1,0			30708851	10104313	
CCGT060208N-...-...	0,2 - 0,5	30799422				
CCGT060208F01N-...-...	0,1 - 1,5			31277724		
CCGT09						
CCGT09T304F01N-...-...	0,1 - 2,0			31079089		
CCGT09T304F01N-...-...	0,1 - 1,0				10099042	
CCGT09T308F01N-...-...	0,1 - 2,0			31277725		
CCGT09T308F01N-...-...	0,15 - 1,4				30234050	

CCGW

Insertos de corte radiales, de doble filo, ejecución neutra

Variantes equipadas,
de un filo:

OAA

Material	K			N		
	GJL ← resistente al desgaste	GJS → tenaz	GJL ← resistente al desgaste	GJS → tenaz	GJL ← resistente al desgaste	GJS → tenaz
Sustrato	Metal duro			PcBN	PCD	
Recubrimiento	CVD		PVD	-	-	
Clase de materiales de corte	HC740		HP930	FU430	PU617	

Diseño de filo de inserto		OA	OA	OAA		
CCGW06 a_p máx. [mm]						
Mecanizado medio	CCGW060204E04N-...-...	0,5 - 3,2	31317178	30950259		
	CCGW060204T51N-...-...	0,5 - 2,0			10105523	
	CCGW060208E04N-...-...	0,5 - 3,2	31317202	30950280		
	CCGW09					
	CCGW09T304E04N-...-...	0,5 - 4,0	31027805	30950281		
	CCGW09T304T51N-...-...	0,5 - 2,5			10105636	
	CCGW09T308E04N-...-...	0,5 - 4,0	31023434	30950282		
	CCGW09T308T51N-...-...	0,5 - 2,5			10105650	
	CCGW09T312E04N-...-...	0,5 - 4,0	31317207	30950283		

Diseño de filo de inserto			OA	OAA	OAA	
CCGW06 a_p máx. [mm]						
Acabado	CCGW060202F01N-...-...	0,1 - 1,0			31277730	
	CCGW060204F01N-...-...	0,1 - 1,0			30492177	
	CCGW060204E01N-...-...	0,1 - 1,0			10105520	
	CCGW060204E02N-...-...	0,2 - 1,0		30950284		
	CCGW060208E02N-...-...	0,2 - 1,0		30950285		
	CCGW09					
	CCGW09T304F01N-...-...	0,1 - 1,0				30418983
	CCGW09T304E01N-...-...	0,1 - 1,0			10105634	
	CCGW09T304E02N-...-...	0,2 - 2,0		30950286		
	CCGW09T308F01N-...-...	0,1 - 1,0				30492178
	CCGW09T308E01N-...-...	0,1 - 1,0			10105648	
	CCGW09T308E02N-...-...	0,2 - 2,0		30950287		

CCHT

Insertos de corte radiales, de doble filo, ejecución izquierda

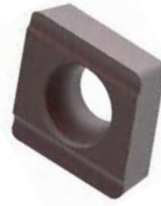

Material	K		N	
Sustrato	Metal duro		Metal duro	
Recubrimiento	CVD	PVD	-	PVD
Clase de materiales de corte	HC740	HP930	HU616	HP615

Diseño de filo de inserto		1L	1L		1R	
CCHT06 a_p máx. [mm]						
Mecanizado medio	CCHT060204E04L-...-...	0,5 - 3,2	31041976	30950288		
	CCHT060208E04L-...-...	0,5 - 3,2	31115820	30950289		
	CCHT09					
	CCHT09T302F01L-...-...	0,5 - 4,0				30492197
	CCHT09T304F01L-...-...	0,5 - 4,0				30478168
	CCHT09T304E04L-...-...	0,5 - 4,0	30963744	30950290		
	CCHT09T308F01L-...-...	0,5 - 4,0				30484471
	CCHT09T308E04L-...-...	0,5 - 4,0	30884324	30950291		
	CCHT09T312E04L-...-...	0,5 - 4,0	30884469	30950292		
	CCHT12					
	CCHT120404E04L-...-...	0,5 - 5,0	30963715	30950293		
	CCHT120408E04L-...-...	0,5 - 5,0	30894700	30950294		
CCHT120412E04L-...-...	0,5 - 5,0	31317213	30950295			

Diseño de filo de inserto			1L	1R	1R	
CCHT06 a_p máx. [mm]						
Acabado	CCHT060202F01L-...-...	0,1 - 1,0			30010702	
	CCHT060204F01L-...-...	0,1 - 1,4			30010703	
	CCHT060204E02L-...-...	0,1 - 1,0		30950296		
	CCHT060208F01L-...-...	0,1 - 1,8			30010704	
	CCHT060208E02L-...-...	0,1 - 1,0		30950297		
	CCHT09					
	CCHT09T302F01L-...-...	0,1 - 2,0			30010705	30492197
	CCHT09T304F01L-...-...	0,1 - 2,0			30010706	30478168
	CCHT09T304E02L-...-...	0,1 - 2,0		30950298		
	CCHT09T308F01L-...-...	0,1 - 2,0			30010707	30484471
	CCHT09T308E02L-...-...	0,1 - 2,0		30950299		
	CCHT09T312F01L-...-...	0,1 - 2,0			30084580	
	CCHT12					
	CCHT120402F01L-...-...	0,1 - 3,0			30010708	
	CCHT120404F01L-...-...	0,1 - 3,0			30010709	
	CCHT120408F01L-...-...	0,1 - 3,0			30010710	
	CCHT120412F01L-...-...	0,1 - 3,0			30010711	

CCHT

Insertos de corte radiales, de doble filo, ejecución derecha



Material	K		N	
Sustrato	Metal duro		Metal duro	
Recubrimiento	CVD	PVD	-	PVD
Clase de materiales de corte	HC740	HP930	HU616	HP615

Diseño de filo de inserto		1L	1L		1R
CCHT06	a_p máx. [mm]				
CCHT060204E04R-...-...	0,5 - 3,2	31317208	30950300		
CCHT060208E04R-...-...	0,5 - 3,2	31317209	30950301		
CCHT09					
CCHT09T304F01R-...-...	0,5 - 4,0				30478169
CCHT09T304E04R-...-...	0,5 - 4,0	31115392	30950302		
CCHT09T308F01R-...-...	0,5 - 4,0				30492211
CCHT09T308E04R-...-...	0,5 - 4,0	31041977	30950303		
CCHT09T312E04R-...-...	0,5 - 4,0	31317210	30950304		
CCHT12					
CCHT120404E04R-...-...	0,5 - 5,0	31317211	30950305		
CCHT120408E04R-...-...	0,5 - 5,0	31317212	30950306		
CCHT120412E04R-...-...	0,5 - 5,0	31317214	30950307		

Diseño de filo de inserto		1L	1R	1R
CCHT06	a_p máx. [mm]			
CCHT060202F01R-...-...	0,1 - 1,0		30010732	
CCHT060204F01R-...-...	0,1 - 1,4		30010733	
CCHT060204E02R-...-...	0,1 - 1,0	30950308		
CCHT060208F01R-...-...	0,1 - 1,8		30010734	
CCHT060208E02R-...-...	0,1 - 1,0	30950309		
CCHT09				
CCHT09T302F01R-...-...	0,1 - 2,0		30010735	
CCHT09T304F01R-...-...	0,1 - 2,0		30010736	30478169
CCHT09T304E02R-...-...	0,1 - 2,0	30950310		
CCHT09T308F01R-...-...	0,1 - 2,0		30010737	30492211
CCHT09T308E02R-...-...	0,1 - 2,0	30950311		
CCHT09T312F01R-...-...	0,1 - 2,0		30492212	
CCHT12				
CCHT120402F01R-...-...	0,1 - 3,0		30010738	
CCHT120404F01R-...-...	0,1 - 3,0		30010739	
CCHT120408F01R-...-...	0,1 - 3,0		30010740	
CCHT120412F01R-...-...	0,1 - 3,0		30010741	

DCMT | DCGT | DCGW

Inserto de corte radial, de doble filo, ejecución neutra



Material	P				
	no aleado resistente al desgaste		aleado tenaz	no aleado resistente al desgaste	aleado tenaz
Sustrato	Metal duro				
Recubrimiento	CVD			PVD	
Clase de materiales de corte	HC850	HC855	HC865	HP880	HP895

Diseño de filo de inserto				MKM		
DCMT11		ap máx. [mm]				
Desbaste	DCMT11T304N-...-...	1,5 - 2,5		30966087		
		1,5 - 3,0				
	DCMT11T308N-...-...	1,5 - 3,0		30966078		
		1,5 - 4,0				

Diseño de filo de inserto		MGP	MGP	MGP	MGP	MGP	
DCMT07		ap máx. [mm]					
Mecanizado medio	DCMT070202N-...-...	0,25 - 1,8					
	DCMT070204N-...-...	0,5 - 2,0	30985499			30985498	
	DCMT070208N-...-...	0,75 - 2,0			31092658		
	DCMT11						
	DCMT11T304N-...-...	0,25 - 2,0	31092656	30985510	30966101	30966092	30966093
	DCMT11T308N-...-...	0,5 - 2,5	30966103	30985518		30966082	30966083
	DCGT11						
	DCGT11T304F01N-...-...	0,4 - 1,5					
	DCGT11T308F01N-...-...	0,5 - 1,8					
	DCMT15						
	DCMT150404N-...-...	0,5 - 2,5					
	DCMT150408N-...-...	0,5 - 3,0					
DCMT150412N-...-...	0,5 - 3,0						

Diseño de filo de inserto		MMM			MMM	MMM	MMM
DCMT07		ap máx. [mm]					
Acabado	DCMT070202N-...-...	0,5 - 1,0			30985495		30985494
	DCMT070204N-...-...	0,5 - 1,0	30986033				30985500
	DCMT070208N-...-...	0,5 - 1,0					
	DCMT11						
	DCMT11T302N-...-...	0,5 - 1,5	30966100				30985505
	DCMT11T304N-...-...	0,5 - 1,5	30985902		30966088	30966095	30966096
	DCMT11T308N-...-...	0,5 - 1,5	30966104		30966079	30966085	30966086
	DCGT11						
	DCGT11T304F01N-...-...	0,1 - 1,0					
	DCGT11T308F01N-...-...	0,15 - 1,4					
	DCGW11						
	DCGW11T304F01N-...-...	0,1 - 2,0					
	DCGW11T304E01N-...-...	0,1 - 1,0					
	DCGW11T308F01N-...-...	0,1 - 2,0					
	DCGW11T308F01N-...-...	0,1 - 1,0					

Variantes equipadas,
de un filo:

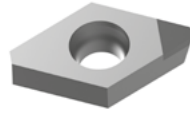

0AA



C1A



C2A

M					K			N			
austenítico resistente al desgaste		ferrítico tenaz	austenítico resistente al desgaste		ferrítico tenaz	GJL resistente al desgaste		GJS tenaz	Al aleado resistente al desgaste		Cu aleado tenaz
Metal duro					Metal duro		PcBN	PCD			
CVD		PVD			CVD		-	-			
HC875	HC885	HP880	HP885	HP895	HC815	HC825	FU430	PU617	PU660	PU670	
					MKM	MKM					
					30985511	30985512					
					30985519	30985520					
	MGP	MGP	MGP	MGP	MGP	MGP				C2A	
					30985493						
				30985498	30985496	30985497					
					30985501	30985502					
	30985508	30966091	30966092	31245560	30966093	30985506	30985507				
	30985517		30966082	31245562	30966083	30985515	30985516				
										30234066	
										30234067	
					30985522						
					30985523						
					30985524						
	MMM		MMM	MMM	MMM	MMM	0AA	0AA	1CA		
	30966105				30985494						
	30966107			31245546	30985500						
				31245547							
					30985505						
			30966095	31245548	30966096	30985513					
	30985903		30966085	31245549	30966086						
										30234052	
										30234053	
									31212079		
							10105921				
									31277726		
							10105952				



SCMT | SPMT | SCGT | SPGT

Inserto de corte radial,
cuatro filos, ejecución neutra

Material	P					
		no aleado resistente al desgaste		aleado tenaz	no aleado resistente al desgaste	aleado tenaz
Sustrato	Cermet	Metal duro				
Recubrimiento	CVD	CVD			PVD	
Clase de materiales de corte	CC112	HC850	HC855	HC865	HP880	HP895

Diseño de filo de inserto			MKM		MKM		
SCMT09	a_p máx. [mm]						
SCMT09T308N-...-...	1,5 - 3,0		31265847		30966072		
	1,5 - 4,0						
SCMT12							
SCMT120408N-...-...	1,5 - 4,0		31265848		30985564		
	1,5 - 5,0						
SCMT120412N-...-...	1,5 - 4,0		31265849				
	1,5 - 5,0						

Diseño de filo de inserto			MGP	MGP	MGP		MGP
SPMT06	a_p máx. [mm]						
SPMT060304N-...-...	0,5 - 2,0		30985573		30985575		
SPMT060308N-...-...	0,75 - 2,0				31265851		
SCMT09							
SCMT09T304N-...-...	0,5 - 3,0		31085129		31085141		30985536
SCMT09T308N-...-...	0,75 - 3,0		31085140	30985543	30966127		
SCMT09T312N-...-...	1 - 3,0		31276723		31273621		
SCGT09							
SCGT09T308F01N-...-...	0,5 - 2,0						
SCMT12							
SCMT120404N-...-...	0,5 - 3,0						
SCMT120408N-...-...	0,75 - 3,0		31085142	30985560	31085143		

Diseño de filo de inserto		U19	MMM		MMM	MMM	MMM
SPMT06	a_p máx. [mm]						
SPMT060304N-...-...	0,5 - 2,0		30985579		30985580	30985577	30985913
SPGT06							
SPGT060304F01N-...-...	0,1 - 0,8						
SPGT060304F01L-...-...	0,1 - 3,0						
SPGT060304F01R-...-...	0,1 - 3,0						
SPGT060308F01N-...-...	0,1 - 0,8						
SPGT060308F01L-...-...	0,1 - 3,0						
SPGT060308F01R-...-...	0,1 - 3,0						
SCMT09							
SCMT09T304N-...-...	0,5 - 1,5		31085144		31085145		30985540
SCMT09T308N-...-...	0,5 - 1,5		30983531		30966073	30966076	30955704
SCGT09							
SCGT09T304N-...-...	0,1 - 0,5	30647885					
SCGT09T304F01N-...-...	0,1 - 0,5						
SCGT09T304F01L-...-...	0,1 - 4,5						
SCGT09T304F01R-...-...	0,1 - 4,5						
SCGT09T308N-...-...	0,1 - 0,5	10102893					
SCGT09T308F01N-...-...	0,1 - 0,5						
SCGT09T308F01N-...-...	0,15 - 1,4						
SCGT09T308F01L-...-...	0,1 - 4,5						
SCGT09T308F01R-...-...	0,1 - 4,5						

Los rangos de a_p especificados son recomendaciones y pueden variar en función del material a mecanizar.

Variantes equipadas,
de un filo:

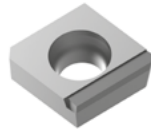

6LA

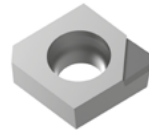

5LA



C1A



C2A

M				K		N			
austenítico resistente al desgaste	ferrítico tenaz	austenítico resistente al desgaste	ferrítico tenaz	GJL resistente al desgaste	GJS tenaz	Al aleado resistente al desgaste		Cu aleado tenaz	
Metal duro				PCD					
CVD		PVD		-					
HC875	HC885	HP880	HP895	HC820	HC830	PU617	PU660	PU670	
				MKM	MKM				
				30985545	31092659				
				30985562	31092660				
				30985566	31092661				
	MGP		MGP	MGP	MGP				C2A
				30985574	30985576				
				30985914	30985915				
30985535			30985536	30985908	30985534				
31092662				30985911	30985912				
									30249457
30985559				30985552	30985554				
				30985556	30985558				
	MMM	MMM	MMM	MMM	MMM	5LA	6LA	C1A	
	30972033	30985577	30985913	30985578	31084646				
						31277727			
							30373268		
							31279699		
						31279698			
							31217111		
							31279720		
			30985540	30985538	30985539				
		30966076	30955704	30985548	30985550				
						30374908			
							30546951		
							31279721		
						30692832			
								30250261	
							30568596		
							31279723		

SCGW | SPGW

Insertos de corte radiales, cuatro filos

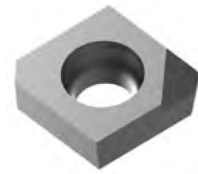

Variantes equipadas, de un filo:

OAA

Material	K			N	
	GJL ← resistente al desgaste	GJS → tenaz	GJL ← resistente al desgaste	GJS → tenaz	GJL ← resistente al desgaste
Sustrato	Metal duro			PcBN	PCD
Recubrimiento	CVD		PVD	-	-
Clase de materiales de corte	HC740		HP930	FU430	PU617

Diseño de filo de inserto		OA	OA	OAA	
SPGW06 a_p máx. [mm]					
Mecanizado medio	SPGW060304E04N-...-...	0,5 - 3,2	31070945	30950312	
	SPGW060308E04N-...-...	0,5 - 3,2	31050739	30950313	
	SCGW09				
	SCGW09T304E04N-...-...	0,5 - 4,0	31022296	30950314	
	SCGW09T304T51N-...-...	0,5 - 2,5			10106285
	SCGW09T308E04N-...-...	0,5 - 4,0	31022297	30950315	
	SCGW09T308T51N-...-...	0,5 - 2,5			10106299
	SCGW12				
	SCGW120404E04N-...-...	0,5 - 5,0	31317220	30950316	
	SCGW120408E04N-...-...	0,5 - 5,0	30939413	30950317	

Diseño de filo de inserto			OA	OAA	OAA
SPGW06 a_p máx. [mm]					
Acabado	SPGW060304F01N-...-...	0,1 - 1,2			31277731
	SPGW060304E02N-...-...	0,2 - 1,0		30950318	
	SPGW060308F01N-...-...	0,1 - 1,0			31279738
	SPGW060308E02N-...-...	0,2 - 1,0		30950319	
	SCGW09				
	SCGW09T304F01N-...-...	0,1 - 1,4			31277732
	SCGW09T304E01N-...-...	0,1 - 1,0		10106283	
	SCGW09T304E02N-...-...	0,2 - 2,0		30950320	
	SCGW09T308F01N-...-...	0,1 - 1,8			30429723
	SCGW09T308E01N-...-...	0,1 - 1,0		10106297	
	SCGW09T308E02N-...-...	0,2 - 2,0		30950321	
	SCGW12				
	SCGW120404F01N-...-...	0,1 - 1,4			31279752
	SCGW120408F01N-...-...	0,1 - 1,8			31279753

Los rangos de a_p especificados son recomendaciones y pueden variar en función del material a mecanizar.

SCHT | SPHT

Insertos de corte radiales, de doble filo, ejecución neutra



Material	K		N
	GJL ← resistente al desgaste	GJS → tenaz	GJL ← resistente al desgaste
Sustrato	Metal duro		Metal duro
Recubrimiento	CVD	PVD	
Clase de materiales de corte	HC740	HP930	HU616

Diseño de filo de inserto		1L	1L		
SPHT06 a_p máx. [mm]					
Mecanizado medio	SPHT060304E04X-...-...	0,5 - 3,2	31042317	30953122	
	SPHT060308E04X-...-...	0,5 - 3,2	31317315	30953126	
	SCHT09				
	SCHT09T304E04X-...-...	0,5 - 4,0	31121604	30953127	
	SCHT09T308E04X-...-...	0,5 - 4,0	30963756	30953128	
	SCHT09T312E04X-...-...	0,5 - 4,0	31317219	30953150	
	SCHT12				
	SCHT120404E04X-...-...	0,5 - 5,0	31081857	30953151	
	SCHT120408E04X-...-...	0,5 - 5,0	31317304	30953152	
SCHT120412E04X-...-...	0,5 - 5,0	31317308	30953154		

Diseño de filo de inserto			1L	1R	
SPHT06 a_p máx. [mm]					
Acabado	SPHT060304E02X-...-...	0,1 - 1,0		30953158	
	SPHT060308E02X-...-...	0,1 - 1,0		30953164	
	SCHT09				
	SCHT09T302F01X-...-...	0,1 - 2,0			30141062
	SCHT09T304F01X-...-...	0,1 - 2,0			30010681
	SCHT09T304E02X-...-...	0,1 - 2,0		30953159	
	SCHT09T308F01X-...-...	0,1 - 2,0			30010682
	SCHT09T308E02X-...-...	0,1 - 2,0		30953168	
	SCHT09T312F01X-...-...	0,1 - 2,0			30492274
	SCHT12				
SCHT120404F01X-...-...	0,1 - 3,0			30010683	
SCHT120408F01X-...-...	0,1 - 3,0			30010684	

SCHT | SPHT

Insertos de corte radiales, cuatro filos



Ejecución izquierda



Ejecución derecha

Material	K		N	
	GJL ← resistente al desgaste	GJS → tenaz	GJL ← resistente al desgaste	GJS → tenaz
Sustrato	Metal duro		Metal duro	
Recubrimiento	CVD		-	PVD
Clase de materiales de corte	HC740		HU616	HP615

Diseño de filo de inserto		2L	2L		2R	
SPHT06 a_p máx. [mm]						
Mecanizado medio	SPHT060302F01L-...-...	0,5 - 3,2			30492231	
	SPHT060302F01R-...-...	0,5 - 3,2			30492248	
	SPHT060304F01L-...-...	0,5 - 3,2			30239958	
	SPHT060304F01R-...-...	0,5 - 3,2			30492249	
	SPHT060304E04L-...-...	0,5 - 3,2	31044035	30950322		
	SPHT060304E04R-...-...	0,5 - 3,2	30939004	30950346		
	SPHT060308F01L-...-...	0,5 - 3,2			30492232	
	SPHT060308F01R-...-...	0,5 - 3,2			30492250	
	SPHT060308E04L-...-...	0,5 - 3,2	31317311	30950323		
	SPHT060308E04R-...-...	0,5 - 3,2	31317314	30950347		
	SCHT09					
	SCHT09T304F01L-...-...	0,5 - 4,0			30492235	
	SCHT09T304F01R-...-...	0,5 - 4,0			30492252	
	SCHT09T304E04L-...-...	0,5 - 4,0	31043583	30950324		
	SCHT09T304E04R-...-...	0,5 - 4,0	30812298	30950348		
	SCHT09T308F01L-...-...	0,5 - 4,0			30042582	
	SCHT09T308F01R-...-...	0,5 - 4,0			30492253	
	SCHT09T308E04L-...-...	0,5 - 4,0	31039585	30950325		
	SCHT09T308E04R-...-...	0,5 - 4,0	31317215	30950349		
	SCHT09T312E04L-...-...	0,5 - 4,0	31317216	30950326		
SCHT09T312E04R-...-...	0,5 - 4,0	31317217	30950350			
SCHT12						
SCHT120404E04L-...-...	0,5 - 5,0	31317284	30950327			
SCHT120404E04R-...-...	0,5 - 5,0	31317287	30950351			
SCHT120408E04L-...-...	0,5 - 5,0	31317300	30950328			
SCHT120408E04R-...-...	0,5 - 5,0	31317301	30950352			
SCHT120412E04L-...-...	0,5 - 5,0	31317305	30950329			
SCHT120412E04R-...-...	0,5 - 5,0	31317307	30950353			

Tabla siguiente:
Acabado



SCHT | SPHT

Insertos de corte radiales, cuatro filos



Ejecución izquierda



Ejecución derecha

Material	K	N	
		Al aleado ← resistente al desgaste	Cu aleado → tenaz
Sustrato		Metal duro	
Recubrimiento	PVD	-	PVD
Clase de materiales de corte	HP930	HU616	HP615

Diseño de filo de inserto		2L	2R	2R
SPHT06	a_p máx. [mm]			
Acabado	SPHT060302F01L-...-...	0,1 - 1,0	30092077	30492231
	SPHT060302F01R-...-...	0,1 - 1,0	30089678	30492248
	SPHT060304F01L-...-...	0,1 - 1,0	30010644	30239958
	SPHT060304F01R-...-...	0,1 - 1,0	30010662	30492249
	SPHT060304E02L-...-...	0,1 - 1,0	30950330	
	SPHT060304E02R-...-...	0,1 - 1,0	30950354	
	SPHT060308F01L-...-...	0,1 - 1,0	30057636	30492232
	SPHT060308F01R-...-...	0,1 - 1,0	30438143	30492250
	SPHT060308E02L-...-...	0,1 - 1,0	30950331	
	SPHT060308E02R-...-...	0,1 - 1,0	30950355	
SCHT09				
Acabado	SCHT09T304F01L-...-...	0,1 - 2,0	30010645	30492235
	SCHT09T304F01R-...-...	0,1 - 2,0	30010663	30492252
	SCHT09T304E02L-...-...	0,1 - 2,0	30950332	
	SCHT09T304E02R-...-...	0,1 - 2,0	30950356	
	SCHT09T308F01L-...-...	0,1 - 2,0	30010646	30042582
	SCHT09T308F01R-...-...	0,1 - 2,0	30010664	30492253
	SCHT09T308E02L-...-...	0,1 - 2,0	30950333	
	SCHT09T308E02R-...-...	0,1 - 2,0	30950357	

TCMT | TCGW

Inserto de corte radial, tres filos, ejecución neutra



Material	P				
	no aleado resistente al desgaste	aleado tenaz	no aleado resistente al desgaste	aleado tenaz	
Sustrato	Metal duro				
Recubrimiento	CVD		PVD		
Clase de materiales de corte	HC850	HC865	HP880	HP895	
Diseño de filo de inserto		MKM			
TCMT11	a_p máx. [mm]				
Desbaste	TCMT110204N-...-...	1,5 - 3,0	30985591		
		1,5 - 4,0			
	TCMT16				
	TCMT16T304N-...-...	1,5 - 3,0	30985608		
		1,5 - 5,0			
		1,5 - 3,0	30985615		
		1,5 - 5,0			
Diseño de filo de inserto		MGP	MGP	MGP	
TCMT09	a_p máx. [mm]				
Mecanizado medio	TCMT090204N-...-...	0,5 - 2,0	30985582		
	TCMT11				
	TCMT110204N-...-...	0,5 - 2,5	30945048	30985589	30985588
	TCMT110208N-...-...	0,75 - 2,5	30985599	30985600	30985601
	TCGW11				
	TCGW110204T51N-...-...	0,5 - 2,5			
	TCGW110208T51N-...-...	0,75 - 2,5			
	TCMT16				
	TCMT16T304N-...-...	0,5 - 2,5	30985605	31092663	30985604
	TCMT16T308N-...-...	0,75 - 2,5	30985613	31092665	30985612
TCMT16T312N-...-...	1,0 - 2,5		31092666		
TCMT22					
TCMT220408N-...-...	0,75 - 3,0				
Diseño de filo de inserto		MMM	MMM	MMM	MMM
TCMT11	a_p máx. [mm]				
Acabado	TCMT110202N-...-...	0,5 - 1,5	30985584	30985585	30985583
	TCMT110204N-...-...	0,5 - 1,5	30985595	30985596	30985594
	TCMT110208N-...-...	0,5 - 1,5			
	TCGW11				
	TCGW110204F01N-...-...	0,1 - 1,0			
	TCGW110204E01N-...-...	0,1 - 1,0			
	TCGW110208F01N-...-...	0,1 - 1,5			
	TCGW110208E01N-...-...	0,1 - 1,0			
	TCMT16				
	TCMT16T304N-...-...	0,5 - 1,5			30985609
TCMT16T308N-...-...	0,5 - 1,5			30985617	



Variantes equipadas, de un filo:

OAA

M				K			N
austenítico resistente al desgaste				ferrítico tenaz	GJL resistente al desgaste	GJS tenaz	
Metal duro				Metal duro		PcBN	PCD
CVD		PVD		CVD		-	-
HC875	HP880	HP885	HP895	HC815	HC825	FU430	PU617
				MKM			
				30985590			
				30985607			
				30985614			
	MGP		MGP	MGP	MGP	OAA	
				30985917			
30985587			30985588	30985586			
30985598		31245563	30985601	30985597			
						30227880	
						30227892	
			30985604	30985602	30985603		
			30985612	30985610	30985611		
		31245564		30985618	30985619		
				30985622	30985623		
	MMM	MMM	MMM	MMM		OAA	OAA
		30985593	31245550	30985583			
			31245551	30985594	30985592		
							31279724
						30227878	
						30227890	31279725
			31245552	30985609			
30985616		31245553	30985617				

Los rangos de ap especificados son recomendaciones y pueden variar en función del material a mecanizar.

TCHT

Inserto de corte radial, de tres filos, ejecución izquierda/derecha



Ejecución izquierda

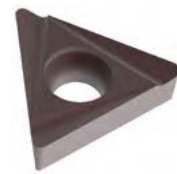

Ejecución derecha

Material	K		N
Sustrato	Metal duro		Metal duro
Recubrimiento	CVD	PVD	
Clase de materiales de corte	HC740	HP930	HU616

Diseño de filo de inserto		2L	2L	
TCHT09	a_p máx. [mm]			
TCHT090204E04L-...-...	0,5 - 2,5	31317317	30950224	
TCHT090204E04R-...-...	0,5 - 2,5	31317318	30950235	
TCHT090208E04L-...-...	0,5 - 2,5	31317319	30950225	
TCHT090208E04R-...-...	0,5 - 2,5	31317320	30950236	
TCHT11				
TCHT110204E04L-...-...	0,5 - 3,0	31317321	30950226	
TCHT110204E04R-...-...	0,5 - 3,0	31317322	30950237	
TCHT110208E04L-...-...	0,5 - 3,0	31317325	30950227	
TCHT110208E04R-...-...	0,5 - 3,0	31317326	30950238	
TCHT16				
TCHT16T304E04L-...-...	0,5 - 4,0	31317327	30950228	
TCHT16T304E04R-...-...	0,5 - 4,0	31317328	30950239	
TCHT16T308E04L-...-...	0,5 - 4,0	31317340	30950229	
TCHT16T308E04R-...-...	0,5 - 4,0	31317342	30950240	

Diseño de filo de inserto		2L	2R
TCHT06	a_p máx. [mm]		
TCHT06T104F01L-...-...	0,1 - 1,0		30492290
TCHT06T104F01R-...-...	0,1 - 1,0		30492307
TCHT06T104E02L-...-...	0,1 - 1,0	30950230	
TCHT06T104E02R-...-...	0,1 - 1,0	30950241	
TCHT09			
TCHT090204F01L-...-...	0,1 - 1,0		30010759
TCHT090204F01R-...-...	0,1 - 1,0		30010777
TCHT090204E02L-...-...	0,1 - 1,0	30950231	
TCHT090204E02R-...-...	0,1 - 1,0	30950242	
TCHT090208E02L-...-...	0,1 - 1,0	30950232	
TCHT090208E02R-...-...	0,1 - 1,0	30950243	
TCHT11			
TCHT110202F01L-...-...	0,1 - 1,5		30010761
TCHT110202F01R-...-...	0,1 - 1,5		30010779
TCHT110204F01L-...-...	0,1 - 1,5		30010762
TCHT110204F01R-...-...	0,1 - 1,5		30010780
TCHT110204E02L-...-...	0,1 - 1,5	30950233	
TCHT110204E02R-...-...	0,1 - 1,5	30950244	
TCHT110208F01L-...-...	0,1 - 1,5		30010763
TCHT110208F01R-...-...	0,1 - 1,5		30478186
TCHT110208E02L-...-...	0,1 - 1,5	30950234	
TCHT110208E02R-...-...	0,1 - 1,5	30950245	
TCHT16			
TCHT16T304F01L-...-...	0,1 - 2,5		30478187
TCHT16T304F01R-...-...	0,1 - 2,5		30478188
TCHT16T308F01L-...-...	0,1 - 2,5		30019882
TCHT16T308F01R-...-...	0,1 - 2,5		30478189

Los rangos de a_p especificados son recomendaciones y pueden variar en función del material a mecanizar.

TCHT

Insertos de corte radiales, de un filo, ejecución neutra



Material	K	N
Sustrato	Metal duro	
Recubrimiento	CVD	PVD
Clase de materiales de corte	HC740	HP930

Diseño de filo de inserto	1L	1L		
TCHT09	a_p máx. [mm]			
Mecanizado medio	TCHT090204E04X-...-...	0,5 - 2,5	31319106	30950246
	TCHT090208E04X-...-...	0,5 - 2,5	31319107	30950247
	TCHT11			
	TCHT110204E04X-...-...	0,5 - 3,0	31319108	30950248
	TCHT110208E04X-...-...	0,5 - 3,0	31319109	30950249
	TCHT16			
	TCHT16T304E04X-...-...	0,5 - 4,0	31039581	30950250
	TCHT16T308E04X-...-...	0,5 - 4,0	31319140	30950251

Diseño de filo de inserto		1L	1R	
TCHT06	a_p máx. [mm]			
Acabado	TCHT06T104F01X-...-...	0,1 - 1,0		30492325
	TCHT06T104E02X-...-...	0,1 - 1,0	30950252	
	TCHT09			
	TCHT090204F01X-...-...	0,1 - 1,0		30010795
	TCHT090204E02X-...-...	0,1 - 1,0	30950253	
	TCHT090208E02X-...-...	0,1 - 1,0	30950254	
	TCHT11			
	TCHT110202F01X-...-...	0,1 - 1,5		30010797
	TCHT110204F01X-...-...	0,1 - 1,5		30010798
	TCHT110204E02X-...-...	0,1 - 1,5	30950255	
	TCHT110208F01X-...-...	0,1 - 1,5		30010799
	TCHT110208E02X-...-...	0,1 - 1,5	30950256	
	TCHT16			
	TCHT16T304F01X-...-...	0,1 - 2,5		30019940
	TCHT16T308F01X-...-...	0,1 - 2,5		30019941

VCMT | VCGT | VBGW | VCGW

Insertos de corte radiales, de doble filo, ejecución neutra



Material		P			
		no aleado ← resistente al desgaste		aleado → tenaz	
Sustrato		Metal duro			
Recubrimiento		CVD		PVD	
Clase de materiales de corte		HC850		HC865	HP880
Diseño de filo de inserto				MKM	
VCMT16		a_p máx. [mm]			
Desbaste	VCMT160408N-...-...	1,5 - 3,0		30985630	
Diseño de filo de inserto		MGP	MGP	MGP	
VCGT11		a_p máx. [mm]			
Mecanizado medio	VCGT110304N-...-...	0,25 - 2,0			30966122
	VCMT16				
	VCMT160404N-...-...	0,5 - 2,0	30966097	30966098	
	VCMT160408N-...-...	0,75 - 2,0	31093307	30985629	
Diseño de filo de inserto					
VBGW16		a_p máx. [mm]			
Acabado	VBGW160404E01N-...-...	0,1 - 1,0			
	VBGW160408E01N-...-...	0,1 - 1,0			
	VCGW16				
	VCGW160404E01N-...-...	0,1 - 1,0			
	VCGW160408E01N-...-...	0,1 - 1,0			



Variantes equipadas,
de un filo:

OAA

	M	K	
	Metal duro	Metal duro	PcBN
	PVD	CVD	-
	HP880	HC815	FU430
	MGP	MGP	
	30966122		
		30985627	
		30985628	
			OAA
			10106686
			10106698
			10106768
			10106780

CCHT | Mecanizado mixto

Insertos de corte radiales, de doble filo, mecanizado mixto



Ejecución derecha



Ejecución izquierda

Material	N + K		N + P			
	GJL ← resistente al desgaste	GJS → tenaz	no aleado ← resistente al desgaste	aleado → tenaz		
Sustrato	Metal duro		Metal duro			
Recubrimiento	PVD		PVD			
Clase de materiales de corte	HP525-P	HP530-P	HP540-P	HP545-P		
Diseño de filo de inserto	1W	1W	1R	1R		
CCHT09	a_p máx. [mm]					
Radio	CCHT09T304E02L-...-...	0,1 - 2,0 *	30909374	30909375	30907411	30909351
	CCHT09T304E02R-...-...	0,1 - 2,0	30909376	30909377	30909352	30909353
	CCHT09T308E02L-...-...	0,1 - 2,0	30909378	30909379	30909354	30909355
	CCHT09T308E02R-...-...	0,1 - 2,0	30909380	30909381	30909356	30909357

* En función del cojinete de empuje.
También posible para insertos especiales.

SCHT | Mecanizado mixto

Insertos de corte radiales, de cuatro filos, mecanizado mixto



con radio,
Ejecución izquierda



con radio,
Ejecución derecha

Material	N + K		N + P	
	GJL resistente al desgaste	GJS tenaz	no aleado resistente al desgaste	aleado tenaz
Sustrato	Metal duro		Metal duro	
Recubrimiento	PVD		PVD	
Clase de materiales de corte	HP525-P	HP530-P	HP540-P	HP545-P

Diseño de filo de inserto		2W	2W	2R	2R	
SCHT09		a_p máx. [mm]				
Radio	SCHT09T304E02L-...-...	0,1 - 2,0	30909366	30909367	30909345	30909346
	SCHT09T304E02R-...-...	0,1 - 2,0	30909368	30909369	30909347	30909348
	SCHT09T308E02L-...-...	0,1 - 2,0	30909370	30909371	30909349	30909350
	SCHT09T308E02R-...-...	0,1 - 2,0	30909372	30909373	30903215	30907589

CTNQ

Insertos de corte tangenciales, de cuatro filos, sin afilado con forma de arco



Material	P			M ₁	
	no aleado resistente al desgaste			aleado tenaz	
Sustrato	Metal duro			Metal duro	
Recubrimiento	CVD		PVD		CVD
Clase de materiales de corte	HC740		HP945	HP950	HC750

Diseño de filo de inserto		H02	H02	H02	A32	
CTNQ desde \varnothing 41 mm a_p máx. [mm]						
Desbaste	CTNQ090508...L-...	1,5 - 3,0	30933846	30933848	30933849	30950088
		1,5 - 4,0				
	CTNQ090508...R-...	1,5 - 3,0	30933850	30933851	30950091	30950092
		1,5 - 4,0				
	CTNQ090512...L-...	1,5 - 3,0	30933852	30933854	30933855	30950094
		1,5 - 4,0				
	CTNQ090512...R-...	1,5 - 3,0	30933856	30933857	30950097	30950099
		1,5 - 4,0				
	CTNQ desde \varnothing 54 mm					
	CTNQ120608...L-...	1,5 - 3,0	30933864	30933866	30933867	
1,5 - 5,0						
CTNQ120612...L-...	1,5 - 3,0	30933868	30933869	30980913		
	1,5 - 5,0					

Diseño de filo de inserto		A32	A32	A32	A32	
CTNQ desde \varnothing 41 mm a_p máx. [mm]						
Mecanizado medio	CTNQ090508...L-...	0,5 - 2,0	30933892	30933894	30933895	30950088
	CTNQ090508...R-...	0,5 - 2,0	30933896	30933897	30950112	30950092
	CTNQ090512...L-...	0,5 - 2,0	30933898	30933900	30933901	30950094
	CTNQ090512...R-...	0,5 - 2,0	30933902	30933903	30950118	30950099

M₁ Acero inoxidable

M₂ Fundición de acero resistente al calor (materiales para turbocompresores)

Los rangos de a_p especificados son recomendaciones y pueden variar en función del material a mecanizar.

M ₂			K			
austenítico resistente al desgaste		ferrítico tenaz	GJL resistente al desgaste	GJS tenaz	GJL resistente al desgaste	GJS tenaz
Metal duro			Metal duro			
CVD		PVD	CVD		PVD	
HC740	HC750	HP945	HC725	HC740	HP930	HP945
H02	H02	H02	H02	H02	H02	H02
30933846	30980873	30933848				
			30933926	30933846	30933929	30933848
30933850	30980900	30933851				
			30933931	30933850	30933934	30933851
30933852	30980902	30933854				
			30933936	30933852	30933939	30933854
30933856	30980905	30933857				
			30933941	30933856	30933944	30933857
30933864	30980907	30933866				
			30933956	30933864	30933959	30933866
30933868	30980911	30933869				
			30933961	30933868	30933964	30933869
A32	A32	A32	A32	A32	A32	A32
30933892	30950088	30933894	30934005	30933892	30934008	30933894
30933896	30950092	30933897	30934010	30933896	30934013	30933897
30933898	30950094	30933900	30934015	30933898	30934018	30933900
30933902	30950099	30933903	30934020	30933902	30934023	30933903

CTGQ

Insertos de corte tangenciales, de cuatro filos, agujero ciego, con afilado con forma de arco



Material	P				K			
	← no aleado resistente al desgaste	→ aleado tenaz	← no aleado resistente al desgaste	→ aleado tenaz	GJL resistente al desgaste	→ GJS tenaz	← GJL resistente al desgaste	→ GJS tenaz
Sustrato	Metal duro				Metal duro			
Recubrimiento	CVD		PVD		CVD		PVD	
Clase de materiales de corte	HC740	HC745	HP945	HP950	HC725	HC740	HP930	HP945

Diseño de filo de inserto	H02	H02	H02	H02	H02	H02	H02	H02
---------------------------	-----	-----	-----	-----	-----	-----	-----	-----

CTGQ ø 65 mm		a_p máx. [mm]								
Desbaste	CTGQ090504... LOOB041-...	1,5 - 3,0	31173955	31173956	31173957	31173958				
		1,5 - 4,0					31173959	31173955	31173980	31173957
	CTGQ090508... LOOB041-...	1,5 - 3,0	31173981	31173982	31173983	31173984				
		1,5 - 4,0					31173985	31173981	31173986	31173983
	CTGQ090512... LOOB041-...	1,5 - 3,0	31173987	31184714	31173988	31184715				
		1,5 - 4,0					31173989	31173987	31173990	31173988
	CTGQ ø 78 mm									
	CTGQ120604... LOOB081-...	1,5 - 3,0	31184725	31184726	31184728	31184729				
		1,5 - 5,0					31184724	31184725	31184727	31184728
	CTGQ120608... LOOB081-...	1,5 - 3,0	31173995	31173996	31173997	31173998				
		1,5 - 5,0					31173999	31173995	31174000	31173997
	CTGQ120612... LOOB081-...	1,5 - 3,0	31184731	31184732	31184734	31184735				
	1,5 - 5,0					31184730	31184731	31184733	31184734	

Diseño de filo de inserto	A32	A32	A32	A32	A32	A32	A32	A32
---------------------------	-----	-----	-----	-----	-----	-----	-----	-----

CTGQ ø 65 mm		a_p máx. [mm]								
Mecanizado medio	CTGQ090504... LOOB041-...	0,5 - 2,0	31174001	31184716	31174002	31184717	31174003	31174001	31174004	31174002
	CTGQ090508... LOOB041-...	0,5 - 2,0	31174005	31184718	31174006	31184719	31174007	31174005	31174008	31174006
	CTGQ090512... LOOB041-...	0,5 - 2,0	31174009	31184720	31174010	31184721	31174011	31174009	31174012	31174010

CTGQ

Insertos de corte tangenciales, de cuatro filos, agujero pasante, con afilado con forma de arco



Material	P				K				
	no aleado resistente al desgaste	aleado tenaz	no aleado resistente al desgaste	aleado tenaz	GJL resistente al desgaste	GJS tenaz	GJL resistente al desgaste	GJS tenaz	
Sustrato	Metal duro				Metal duro				
Recubrimiento	CVD		PVD		CVD		PVD		
Clase de materiales de corte	HC740	HC745	HP945	HP950	HC725	HC740	HP930	HP945	
Diseño de filo de inserto	H02	H02	H02	H02	H02	H02	H02	H02	
CTGQ desde \varnothing 65 mm a_p máx. [mm]									
Desbaste	CTGQ090508... L10B041-...	1,5 - 3,0	31174013	31174014	31174015	31174016			
		1,5 - 4,0					31174017	31174013	31174018
	CTGQ desde \varnothing 78 mm								
	CTGQ120608... L10B081-...	1,5 - 3,0	31174019	31174020	31174021	31174022			
	1,5 - 5,0					31174023	31174019	31174024	31174021
Diseño de filo de inserto	A32	A32	A32	A32	A32	A32	A32	A32	
CTGQ desde \varnothing 65 mm a_p máx. [mm]									
Mecanizado medio	CTGQ090508... L10B041-...	0,5 - 2,0	31174029	31184722	31174031	31184723	31174030	31174029	31174032
									31174031

CTHQ

Insertos de corte tangenciales, de cuatro filos, sin afilado con forma de arco



Ejecución izquierda



Ejecución derecha

Material	P		M ₁	M ₂		M ₂
Sustrato	Metal duro		Metal duro	Metal duro		Metal duro
Recubrimiento	CVD	PVD	CVD	CVD		PVD
Clase de materiales de corte	HC740	HP945	HC750	HC740	HC750	HP945

Diseño de filo de inserto							
CTHQ desde \varnothing 28 mm a_p máx. [mm]							
Desbaste	CTHQ060408...L-...	1,5 - 2,5					
	CTHQ060408...R-...	1,5 - 2,5					
	Diseño de filo de inserto			A32	H02	H02	H02
	CTHQ desde \varnothing 41 mm a_p máx. [mm]						
	CTHQ090508...L-...	1,5 - 3,0		30950084	30980629	30980631	30980632
		1,5 - 4,0					
	CTHQ090508...R-...	1,5 - 3,0		30950086	30980712	30980714	30980751
		1,5 - 4,0					
	CTHQ desde \varnothing 54 mm						
	CTHQ120608...L-...	1,5 - 3,0			30980759	30980765	30980766
1,5 - 5,0							
CTHQ120608...R-...	1,5 - 3,0			30980784	30980786	30980787	
	1,5 - 5,0						
Diseño de filo de inserto		A32	A32		A32	A32	A32
CTHQ desde \varnothing 28 mm a_p máx. [mm]							
Mecanizado medio	CTHQ060404...R-...	0,5 - 2,0					
	CTHQ desde \varnothing 41 mm						
	CTHQ090504...L-...	0,5 - 2,0	30933878	30933880		30933878	30980967
	CTHQ090504...R-...	0,5 - 2,0				30980968	
	CTHQ090508...L-...	0,5 - 2,0	30813598	30933885		30813598	30950084
	CTHQ090508...R-...	0,5 - 2,0				30950086	
	CTHQ desde \varnothing 54 mm						
	CTHQ120604...L-...	0,5 - 2,0	30933904			30933904	
CTHQ120604...R-...	0,5 - 2,0	30980051			30980051		

M₁ Acero inoxidable

M₂ Fundición de acero resistente al calor (materiales para turbocompresores)

Los rangos de a_p especificados son recomendaciones y pueden variar en función del material a mecanizar.



Variantes equipadas,
de un filo:

A79, A80

K				N		
GJL ← resistente al desgaste		GJS → tenaz	GJL ← resistente al desgaste	GJS → tenaz		
Metal duro				Metal duro		PCD
CVD		PVD		-	PVD	-
HC725	HC740	HP930	HP945	HU616	HP615	PU617
H32	H32	H32	H32			
30933907	30980615	30933910	30980618			
30933912	30980621		30980625			
H02	H02	H02	H02			A80
30921024	30980629	30933917	30980632			30492720
30921023	30980712	30933923	30980751			30515656
30933946	30980759	30933949	30980766			
30933951	30980784	30933954	30980787			
A32	A32	A32	A32	A30	A30	A80
30679873	30942364		30942366	30477914	31010211	
30679874	30933878	30933979	30933880	30492760	31010211	30492764
30679875		30942374		30492770		30515411
30724676	30813598	30933994	30933885	31186236	30610917	
30789885		30942382		31264530	31203830	
30789886	30933904	30934028		30477929		
30789887	30980051	30980054		30477930		

CTHQ

Insertos de corte tangenciales, de cuatro filos, agujero ciego, con afilado con forma de arco



Material	P				M ₂	
	no aleado resistente al desgaste	aleado tenaz	no aleado resistente al desgaste	aleado tenaz		
Sustrato	Metal duro				Metal duro	
Recubrimiento	CVD		PVD		CVD	
Clase de materiales de corte	HC740	HC745	HP945	HP950	HC750	

Diseño de filo de inserto	A53	A53	A53	A53	A32		
CTHQ desde ø 65 mm a_p máx. [mm]							
Desbaste	CTHQ090508... L00B041-...	1,5 - 3,0	30933714	30933715	30933716	30933717	30933718
		1,5 - 4,0					
	CTHQ090512... L00B041-...	1,5 - 3,0	30950047				
		1,5 - 4,0					
	CTHQ desde ø 78 mm						
	CTHQ120608... L00B081-...	1,5 - 3,0	30933733	30933734			
	1,5 - 5,0						
CTHQ120612... L00B081-...	1,5 - 3,0	30950048					
	1,5 - 5,0						

Diseño de filo de inserto	A32		A32				
CTHQ desde ø 40 mm a_p máx. [mm]							
Mecanizado medio	CTHQ060404... L00B021-...	0,5 - 2,0					
		0,5 - 2,0					
	CTHQ desde ø 65 mm						
	CTHQ090504... L00B041-...	0,5 - 2,0	30950080		30988741		
	CTHQ090508... L00B041-...	0,5 - 2,0	30988732		30988742		
	CTHQ desde ø 78 mm						
	CTHQ120604... L00B081-...	0,5 - 2,0					
	CTHQ120608... L00B081-...	0,5 - 2,0	30988734		30988744		

M₂ Fundición de acero resistente al calor (materiales para turbocompresores)

Los rangos de a_p especificados son recomendaciones y pueden variar en función del material a mecanizar.



Variantes equipadas,
de un filo:

A79, A80

K				N	
GJL ← resistente al desgaste		GJS → tenaz	GJL ← resistente al desgaste	GJS → tenaz	
Metal duro				Metal duro	PCD
CVD		PVD		-	-
HC725	HC740	HP930	HP945	HU616	PU617
H02	H02	H02	H02		A80
30933721	30988707	30933724	30988736		30492584
30933727	30988708	30933730	30988737		
30933735	30988709	30933738	30988738		
	30988730		30988739		
A32	A32	A32	A32	A30	A80
30679863	30988748	30933807	30988753	30477915	30492616
30679858	30950080	30933756	30988741	30328643	
30679859	30988732	30933765	30988742	30307194	30492584
30789881	31322355	31322356	31322357	30477928	
30789882	30988734	30933777	30988744	30477931	31213527

CTHQ



Insertos de corte tangenciales, de cuatro filos, agujero pasante, con afilado con forma de arco

Material	P				M ₂		
	no aleado resistente al desgaste	aleado tenaz	no aleado resistente al desgaste	aleado tenaz			
Sustrato	Metal duro				Metal duro		
Recubrimiento	CVD		PVD		CVD		
Clase de materiales de corte	HC740	HC745	HP945	HP950	HC750		
Diseño de filo de inserto	A53	A53	A53	A53	A32		
CTHQ desde ø 65 mm a _p máx. [mm]							
Desbaste	CTHQ090508... L10B041-...	1,5 - 3,0	30933783	30933784	30933785	30933786	30933787
	CTHQ desde ø 78 mm						
	CTHQ120608... L10B081-...	1,5 - 3,0	30950082				
		1,5 - 5,0					
Diseño de filo de inserto	A32		A32				
CTHQ desde ø 40 mm a _p máx. [mm]							
Mecanizado medio	CTHQ060408... L10B021-...	0,5 - 2,0					
	CTHQ desde ø 65 mm						
	CTHQ090508... L10B041-...	0,5 - 2,0	30988749		30988755		
	CTHQ desde ø 78 mm						
	CTHQ120608... L10B081-...	0,5 - 2,0	30988750		30988756		

M₂ Fundición de acero resistente al calor (materiales para turbocompresores)

Los rangos de a_p especificados son recomendaciones y pueden variar en función del material a mecanizar.



Variantes equipadas,
de un filo:

A79, A80

K				N	
GJL ← resistente al desgaste		GJS → tenaz	GJL ← resistente al desgaste	GJS → tenaz	
Metal duro				Metal duro	PCD
CVD		PVD		-	-
HC725	HC740	HP930	HP945	HU616	PU617
H02	H02	H02	H02		A80
30933790	30988746	30933793	30988751		30492657
30933796	30988747	30933799	30988752		
A32	A32	A32	A32	A30	A80
30679863	30988748	30933807	30988753	30477916	
30679865	30988749	30933825	30988755	30307197	30492657
	30988750		30988756	30477932	

FTNQ

Insertos de corte tangenciales, de cuatro filos, sin afilado con forma de arco



Material	P		M ₁	M ₂	
				austenítico resistente al desgaste	ferrítico tenaz
Sustrato	Metal duro		Metal duro	Metal duro	
Recubrimiento	CVD	PVD	CVD	CVD	
Clase de materiales de corte	HC740	HP945	HC750	HC740	HC750

Diseño de filo de inserto	H02	H02	A32	H02	H02
---------------------------	-----	-----	-----	-----	-----

FTNQ desde \varnothing 30 mm a_p máx. [mm]

Desbaste	FTNQ090508...L-...	1,5 - 3,0	30934169	30934170	30934171	30934169	30980508
		1,5 - 4,0					
	FTNQ desde \varnothing 40 mm						
	FTNQ120608...L-...	1,5 - 3,0	30934188	30934189		30934188	30980523
		1,5 - 5,0					
	FTNQ120608...R-...	1,5 - 3,0	30934196	30934197		30934196	
1,5 - 5,0							

Diseño de filo de inserto	A32	A32		A32	A32
---------------------------	-----	-----	--	-----	-----

FTNQ desde \varnothing 30 mm a_p máx. [mm]

Mecanizado medio	FTNQ090508...L-...	0,5 - 2,0	30934222	30934223		30934222	30934171
		0,5 - 2,0					

M₁ Acero inoxidable

M₂ Fundición de acero resistente al calor (materiales para turbocompresores)

Los rangos de a_p especificados son recomendaciones y pueden variar en función del material a mecanizar.

	M₂	K			
	Metal duro	Metal duro			
	PVD	CVD		PVD	
HP945	HC725	HC740	HP930	HP945	
	H02	H02	H02	H02	H02
	30934170				
		30934173	30934169	30934175	30934170
	30934189				
		30934192	30934188	30934194	30934189
	30934197				
		30934198	30934196	30934200	30934197
	A32	A32	A32	A32	A32
	30934223				
		30934173	30934222	30934175	30934223

FTGQ

Insertos de corte tangenciales, de cuatro filos, agujero ciego, con afilado con forma de arco



Material	P				K			
	no aleado ← resistente al desgaste	aleado → tenaz	no aleado ← resistente al desgaste	aleado → tenaz	GJL ← resistente al desgaste	GJS → tenaz	GJL ← resistente al desgaste	GJS → tenaz
Sustrato	Metal duro				Metal duro			
Recubrimiento	CVD		PVD		CVD		PVD	
Clase de materiales de corte	HC740	HC745	HP945	HP950	HC725	HC740	HP930	HP945

Diseño de filo de inserto		H02	H02	H02	H02	H02	H02	H02	H02	
FTGQ desde \varnothing 30 mm		a_p máx. [mm]								
Desbaste	FTGQ090504...L00B016- ...	1,5 - 3,0	31174033	31174034	31174035	31174036				
		1,5 - 4,0					31174037	31174033	31174038	31174035
	FTGQ090508...L00B016- ...	1,5 - 3,0	31174039	31174040	31174041	31174042				
		1,5 - 4,0					31174043	31174039	31174044	31174041
	FTGQ090512...L00B016- ...	1,5 - 3,0	31184737	31184738	31184740	31184741				
		1,5 - 4,0					31184736	31184737	31184739	31184740
	FTGQ desde \varnothing 40 mm									
	FTGQ120604...L00B021- ...	1,5 - 3,0	31184755	31184756	31184758	31184759				
		1,5 - 5,0					31184754	31184755	31184757	31184758
	FTGQ120608...L00B021- ...	1,5 - 3,0	31174045	31174046	31174047	31174048				
		1,5 - 5,0					31174049	31174045	31174050	31174047
	FTGQ120612...L00B021- ...	1,5 - 3,0	31184761	31184762	31184764	31184765				
	1,5 - 5,0					31184760	31184761	31184763	31184764	

Diseño de filo de inserto		A32	A32	A32	A32	A32	A32	A32	A32	
FTGQ desde \varnothing 30 mm		a_p máx. [mm]								
Mecanizado medio	FTGQ090504...L00B016- ...	0,5 - 2,0	31174051	31184742	31174053	31184743	31174052	31174051	31174054	31174053
	FTGQ090508...L00B016- ...	0,5 - 2,0	31174055	31184744	31174057	31184745	31174056	31174055	31174058	31174057
	FTGQ090512...L00B016- ...	0,5 - 2,0	31184747	31184748	31184750	31184751	31184746	31184747	31184749	31184750

FTGQ

Insertos de corte tangenciales, de cuatro filos, agujero pasante, con afilado con forma de arco



Material	P				K					
	no aleado resistente al desgaste	aleado tenaz	no aleado resistente al desgaste	aleado tenaz	GJL resistente al desgaste	GJS tenaz	GJL resistente al desgaste	GJS tenaz		
Sustrato	Metal duro				Metal duro					
Recubrimiento	CVD		PVD		CVD		PVD			
Clase de materiales de corte	HC740	HC745	HP945	HP950	HC725	HC740	HP930	HP945		
Diseño de filo de inserto	H02	H02	H02	H02	H02	H02	H02	H02		
FTGQ desde \varnothing 30 mm	a_p máx. [mm]									
Desbaste	FTGQ090508...L10B016-	1,5 - 3,0	31174059	31174060	31174061	31174062				
	...	1,5 - 4,0					31174063	31174059	31174065	
	FTGQ desde \varnothing 40 mm									
	FTGQ120608...L10B021-	1,5 - 3,0	31174066	31174067	31174068	31174069				
...	1,5 - 5,0					31174070	31174066	31174071	31174068	
Diseño de filo de inserto	A32	A32	A32	A32	A32	A32	A32	A32		
FTGQ desde \varnothing 30 mm	a_p máx. [mm]									
Mecanizado medio	FTGQ090508...L10B016-	0,5 - 2,0	31174076	31184752	31174078	31184753	31174077	31174076	31174079	
	...								31174078	

FTHQ

Insertos de corte tangenciales, de cuatro filos, sin afilado con forma de arco



Material	P		M ₁		
			austenítico resistente al desgaste ← ferrítico → tenaz		
Sustrato	Metal duro		Metal duro		
Recubrimiento	CVD	PVD	CVD	PVD	
Clase de materiales de corte	HC740	HP945	HC750	HC740	HC750

Diseño de filo de inserto		A53	A53	A32	H02	H02	
FTHQ desde ø 30 mm a _p máx. [mm]							
Desbaste	FTHQ090508...L-...	1,5 - 3,0	30980167	30934159	30934160	30912756	30980484
		1,5 - 4,0					
	FTHQ090508...R-...	1,5 - 3,0	30934166	30934167	30950130	30980488	
		1,5 - 4,0					
	FTHQ desde ø 40 mm						
	FTHQ120608...L-...	1,5 - 3,0	30934177	30934178	30934179	30980491	30980493
	1,5 - 5,0						
FTHQ120608...R-...	1,5 - 3,0	30934185	30934186	30950135	30980501		
	1,5 - 5,0						

Diseño de filo de inserto		A32	A32		A32	A32	
FTHQ desde ø 22 mm a _p máx. [mm]							
Mecanizado medio	FTHQ060404...L-...	0,5 - 1,5					
	FTHQ060404...R-...	0,5 - 1,5					
	FTHQ060408...L-...	0,5 - 1,5					
	FTHQ060408...R-...	0,5 - 1,5					
	FTHQ desde ø 30 mm						
	FTHQ090504...L-...	0,5 - 2,0					
	FTHQ090504...R-...	0,5 - 2,0					
	FTHQ090508...L-...	0,5 - 2,0	30934214	30934215		30934214	30934160
	FTHQ090508...R-...	0,5 - 2,0					30950130
	FTHQ desde ø 40 mm						
	FTHQ120604...L-...	0,5 - 2,0					
	FTHQ120604...R-...	0,5 - 2,0					
	FTHQ120608...L-...	0,5 - 2,0	30934231	30934232		30934231	30934179
	FTHQ120608...R-...	0,5 - 2,0					30950135

M₁ Acero inoxidable

M₂ Fundición de acero resistente al calor (materiales para turbocompresores)

Los rangos de a_p especificados son recomendaciones y pueden variar en función del material a mecanizar.

FTHQ

Insertos de corte tangenciales, de cuatro filos, agujero ciego, con afilado con forma de arco



Material	P		M	
	no aleado ← resistente al desgaste	aleado → tenaz	no aleado ← resistente al desgaste	aleado → tenaz
Sustrato	Metal duro		Metal duro	
Recubrimiento	CVD		PVD	
Clase de materiales de corte	HC740		HP945	

Diseño de filo de inserto		A53	A53	A32	
FTHQ desde ϕ 30 mm a_p máx. [mm]					
Desbaste	FTHQ090508... L00B016-...	1,5 - 3,0	30980181	30934058	
	FTHQ090512...L00B016- ...	1,5 - 3,0	30934075	30934076	
	FTHQ desde ϕ 40 mm				
	FTHQ120608... L00B021-...	1,5 - 3,0	30934081	30934082	
	FTHQ120612...L00B021- ...	1,5 - 3,0	30934087	30934088	
		1,5 - 5,0			

Diseño de filo de inserto		A32			
FTHQ desde ϕ 22 mm a_p máx. [mm]					
Mecanizado medio	FTHQ060404...L00B012-...	0,5 - 1,5			
	FTHQ060408...L00B012-...	0,5 - 1,5			
	FTHQ desde ϕ 30 mm				
	FTHQ090504...L00B016-...	0,5 - 2,0	30950123		
	FTHQ090508...L00B016-...	0,5 - 2,0	30901249		
	FTHQ desde ϕ 40 mm				
	FTHQ120604...L00B021-...	0,5 - 2,0			
	FTHQ120608...L00B021-...	0,5 - 2,0	30934113		
FTHQ120612...L00B021-...	0,5 - 2,0				



Variantes equipadas,
de un filo:

A79, A80

K		K		N		
GJL ← resistente al desgaste		GJS → tenaz	GJL ← resistente al desgaste		GJS → tenaz	
Metal duro CVD		Metal duro PVD		Metal duro	PCD	
HC725	HC740	HP930	HP945	HU616	PU617	
H02	H02	H02	H02			A80
30934071	30934057	30934073	30988760			30492784
30934077	30988757	30934079	30988761			
30934083	30988758	30934085	30988762			
30934089	30988759	30934091	30988763			
A32	A32	A32	A32	A30	A79	A80
30679879	30950121	30934095	30988764	30477935		
30679880	30950122	30934099	30988765	30477936	30492816	
30679881	30950123	30934103	30988766	30477942		
30679882	30901249	30934111	30934106	30478043		30492784
30934115	30934113	30934118	30934114	30477950		
				30477952		
				30492842		

FTHQ

Insertos de corte tangenciales, de cuatro filos, agujero pasante, con afilado con forma de arco

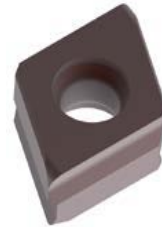

Material	P		M	K		
	Metal duro		Metal duro	Metal duro		
Sustrato	CVD		PVD	CVD		
Recubrimiento	HC740		HP945	HC750	HC725 HC740	
Clase de materiales de corte	A53		A53	A32	H02 H02	
Diseño de filo de inserto	A53		A53	A32	H02 H02	
FTHQ desde \varnothing 30 mm a_p máx. [mm]	A53		A53	A32	H02 H02	
Desbaste	FTHQ090508...L10B016-	1,5 - 3,0	30934120	30934121	30934122	
	...	1,5 - 4,0				30934124 30988767
	FTHQ desde \varnothing 40 mm					
	FTHQ120608...L10B021-	1,5 - 3,0	30934128	30934129		
...	1,5 - 5,0				30934130 30988768	
Diseño de filo de inserto	A32		A32	A32	A32	
FTHQ desde \varnothing 22 mm a_p máx. [mm]	A32		A32	A32	A32	
Mecanizado medio	FTHQ060408...L10B012-...	0,5 - 1,5				30679886 30942386
	FTHQ desde \varnothing 30 mm					
	FTHQ090508...L10B016-...	0,5 - 2,0	30942389	30942390		30679888 30942389
	FTHQ desde \varnothing 40 mm					
FTHQ120608...L10B021-...	0,5 - 2,0	30942391	30942392		30789889 30942391	



Variantes equipadas,
de un filo:

A79, A80

K		N		
GJL ← resistente al desgaste		GJS → tenaz		
Metal duro		Metal duro		PCD
PVD		-		-
HP930	HP945	HU616		PU617
H02	H02			A80
30934126	30988769			30492850
30934132	30988770			30668155
A32	A32	A30	A79	A80
30942394	30942388	30477937	30492868	
30942397	30942390	30477944		30492850
30942400	30942392	30477953		30668155

STHD – STHE

Insertos de corte tangenciales, de cuatro filos, biseles, ejecución neutra



Variantes equipadas,
de un filo:

D80

Material	M ₂	K		N	
Sustrato	Metal duro	Metal duro		Metal duro	PCD
Recubrimiento	PVD	CVD	PVD	-	-
Clase de materiales de corte	HP930	HC725	HP930	HU616	PU617



Diseño de filo de inserto		D02	D02	D02	D00	D80	
STH_06	a_p máx. [mm]						
Biseles	STHD060300...N-...	0,1 - 4,2	30950141	30774242	30950141	30213884	30493003
	STHE060300...N-...	0,1 - 4,2	30950142	30789899	30950142	30228119	30370122
	STH_09						
	STHD09T300...N-...	0,1 - 6,3	30950143	30631370	30950143	30215016	30493005
	STHE09T300...N-...	0,1 - 6,3	30950144	30631351	30950144	30257365	30493006

M₂ Fundición de acero resistente al calor (materiales para turbocompresores)

Los rangos de a_p especificados son recomendaciones y pueden variar en función del material a mecanizar.

Notas







Accesorios para insertos de corte tangenciales

Inserto de corte	Tamaño del inserto de corte reversible	Tornillo de sujeción					Destornillador
		Dimensión [MxL]	Denominación	Par de apriete [Nm]	Tamaño Torx	Referencia	Referencia
CT... 	0604	M2.5 x 8.7	MN659 M2.5x8.7-TX8-IP	1	TX8-IP	30533284	30414760
	0905	M3.5 x 11	MN659 M3.5x11-TX10-IP	2,8	TX10-IP	10105079	30414763
	1206	M5 x 14	MN659 M5x14-TX20-IP	7,5	TX20-IP	10006485	30414766
FT... 	0604	M2.5 x 8.7	MN659 M2.5x8.7-TX8-IP	1	TX8-IP	30533284	30414760
	0905	M3.5 x 11	MN659 M3.5x11-TX10-IP	2,8	TX10-IP	10105079	30414763
	1206	M5x14	MN659 M5x14-TX20-IP	7,5	TX20-IP	10006485	30414766
ST... 	0603	M2.5 x 6	MN659 M2.5x6-TX8-IP	1	TX8-IP	10105073	30414760
	09T3	M3.5x9	MN659 M3.5x9-TX15-IP	2,8	TX15-IP	10105078	30414764

Pasta para tornillos para alta temperatura

Pasta de cerámica/tubo de PE 30 g, con cierre	30861389	
---	----------	--

Accesorios para insertos de corte radiales

Inserto de corte	Tamaño del inserto de corte reversible	Tornillo de sujeción					Destornillador
		Dimensión [Mxl]	Denominación	Par de apriete [Nm]	Tamaño Torx	Referencia	Referencia
CC... 	0602	M2.5 x 6	MN659 M2.5x6-TX8-IP	1	TX8-IP	10105073	30414760
	09T3	M3.5 x 9	MN659 M3.5x9-TX15-IP	2,8	TX15-IP	10105078	30414764
	1204	M5 x 11	MN659 M5x11-TX20-IP	7,5	TX20-IP	10105082	30414766
DC... 	0702	M2.5 x 6	MN659 M2.5x6-TX8-IP	1	TX8-IP	10105073	30414760
	11T3	M3.5 x 9	MN659 M3.5x9-TX15-IP	2,8	TX15-IP	10105078	30414764
	1504	M5x11	MN659 M5x11-TX20-IP	7,5	TX20-IP	10105082	30414766
SP... 	0603	M2.5 x 6	MN659 M2.5x6-TX8-IP	1	TX8-IP	10105073	30414760
TC... 	06T1	M2 x 4.95	MN659 M2x4.95-TX6-IP	0,5	TX6-IP	10002712	30414758
	0902	M2.2 x 5.5	MN659 M2.2x5.5-TX7-IP	0,8	TX7-IP	10105070	30414759
	1102	M2.5 x 6	MN659 MN2.5x6-TX8-IP	1	TX8-IP	10105073	30414760
	16T3	M3.5 x 9	MN659 M3.5x9-TX15-IP	2,8	TX15-IP	10105078	30414764
	2204	M5x11	MN659 M5x11-TX20-IP	7,5	TX20-IP	10105082	30414766
SC... 	09T3	M3.5 x 9	MN659 M3.5x9-TX15-IP	2,8	TX15-IP	10105078	30414764
	1204	M5 x 11	MN659 M5x11-TX20-IP	7,5	TX20-IP	10105082	30414766
VB-/VC... 	1103	M2.5 x 6	MN659 MN2.5x6-TX8-IP	1	TX8-IP	10105073	30414760
	1604	M3.5 x 9	MN659 M3.5x9-TX15-IP	2,8	TX15-IP	10105078	30414764

Recomendación de valores de corte para herramientas de mandrinado con inserto de corte (1/2)

Velocidad de corte [m/min]

Grupo de arranque de virutas de Mapal*	Material		Rigidez/dureza [N/mm ²] [HRC]	Cermet		PcBN	
				Con recubrimiento de CVD	Con recubrimiento PVD	sin revestir	
				CC112	CP872	FU430	
P	P1	P1.1	Aceros de construcción, para tornos automáticos, de cementación y revenidos, no aleados	< 700	160-600	200-300	
		P1.2	Aceros de construcción, para tornos automáticos, de cementación y revenidos, no aleados	< 1200	160-500		
	P2	P2.1	Aceros nitrurados, de cementación y aceros revenidos, aleados	< 900	160-600	120-220	
		P2.2	Aceros nitrurados, de cementación y aceros revenidos, aleados	< 1400	140-400		
	P3	P3.1	Aceros para herramientas, rodamientos, resortes y rápidos**	< 800	160-600	120-220	
		P3.2	Aceros para herramientas, rodamientos, resortes y rápidos**	< 1000	140-400		
		P3.3	Aceros para herramientas, rodamientos, resortes y rápidos**	< 1500			
	P4	P4.1	Aceros para herramientas, rodamientos, resortes y rápidos**		140-400		
	P5	P5.1	Aceros inoxidables, ferríticos y martensíticos		140-400		
	P6	P6.1	Fundición de acero		140-400		
M	M1	M1.1	Fundición de acero inoxidable, ferrítica y martensítica	< 700	100-500		
		M1.2	Aceros inoxidables, ferríticos/austeníticos (dúplex)	< 1000	100-450		
	M2	M2.1	Fundición de acero inoxidable, austenítica	< 700	100-500		
	M3	M3.1	Fundición de acero inoxidable, ferrítica/austenítica (dúplex)	< 1000	100-450		
K	K1	K1.1	Hierro fundido con grafito laminar (fundición gris), GJL	< 300		400-1000	140-300
		K2.1	Hierro fundido con grafito esferoidal, GJS	< 500		350-800	120-260
	K2	K2.2	Hierro fundido con grafito esferoidal, GJS	≤ 800			120-220
		K2.3	Hierro fundido con grafito esferoidal, GJS	> 800			80-140
	K3	K3.1	Hierro fundido con grafito vermicular, GJV; fundición maleable, GJM	< 500			80-130
		K3.2	Hierro fundido con grafito vermicular, GJV; fundición maleable, GJM	> 500			80-120
N	N1	N1.1	Aluminio, aleado y no aleado < 3 % Si				
		N1.2	Aluminio, aleado ≤ 7 % Si				
		N1.3	Aluminio, aleado > 7-12 % Si				
		N1.4	Aluminio, aleado > 12 % Si				
	N2	N2.1	Cobre, no aleado y de baja aleación	< 300			
		N2.2	Cobre, aleado	> 300			
		N2.3	Latón, bronce, fundición roja	< 1200			
	N3	N3.1	Grafito, > 8 μm	< 1200			
		N3.2	Grafito, ≤ 8 μm				
	N4	N4.1	Plástico, termoplásticos				
N4.2		Plástico, plásticos termoestables					
N4.3		Plástico, espumas					
K+K	K1.1, K1.2	Mecanizado mixto de hierro fundido (GJL y GJS)					
K+P	K1.1, Sinter	Mecanizado mixto de hierro fundido y acero sinterizado					
N+K	N1.2, K1.1	Mecanizado mixto de aluminio y hierro fundido (GJL)					
	N1.2, K1.2	Mecanizado mixto de aluminio y hierro fundido (GJS)					
N+P	N1.2, Sinter	Mecanizado mixto de aluminio y acero sinterizado					

* Grupos de mecanizado MAPAL

** Si los componentes de aleación de Cr, Mo, Ni, V, W suman > 8 %, elegir el siguiente grupo de mecanizado MAPAL superior.

Recomendación de valores de corte para herramientas de mandrinado con inserto de corte (2/2)

Velocidad de corte [m/min]

Grupo de arranque de virutas de Mapal*	Material	Rigidez/dureza [N/mm ²] [HRC]	Con recubrimiento de PV					
			HP615	HP880	HP885	HP895		
P	P1	P1.1	Aceros de construcción, para tornos automáticos, de cementación y revenidos, no aleados	< 700		100-220	100-220	
		P1.2	Aceros de construcción, para tornos automáticos, de cementación y revenidos, no aleados	< 1200		100-220	100-220	
	P2	P2.1	Aceros nitrurados, de cementación y aceros revenidos, aleados	< 900		100-220	100-220	
		P2.2	Aceros nitrurados, de cementación y aceros revenidos, aleados	< 1400		100-200	100-200	
	P3	P3.1	Aceros para herramientas, rodamientos, resortes y rápidos**	< 800		80-200	80-200	
		P3.2	Aceros para herramientas, rodamientos, resortes y rápidos**	< 1000		80-200	80-200	
		P3.3	Aceros para herramientas, rodamientos, resortes y rápidos**	< 1500				
	P4	P4.1	Aceros para herramientas, rodamientos, resortes y rápidos**			80-200	80-200	
	P5	P5.1	Aceros inoxidables, ferríticos y martensíticos			80-200	80-200	
	P6	P6.1	Fundición de acero					
M	M1	M1.1	Fundición de acero inoxidable, ferrítica y martensítica	< 700		150-220	100-180	150-220
		M1.2	Aceros inoxidables, ferríticos/austeníticos (dúplex)	< 1000		120-200	100-160	120-200
	M2	M2.1	Fundición de acero inoxidable, austenítica	< 700		100-180	80-150	100-180
	M3	M3.1	Fundición de acero inoxidable, ferrítica/austenítica (dúplex)	< 1000		100-180	60-140	100-180
K	K1	K1.1	Hierro fundido con grafito laminar (fundición gris), GJL	< 300				
		K2.1	Hierro fundido con grafito esferoidal, GJS	< 500				
	K2	K2.2	Hierro fundido con grafito esferoidal, GJS	≤ 800				
		K2.3	Hierro fundido con grafito esferoidal, GJS	> 800				
	K3	K3.1	Hierro fundido con grafito vermicular, GJV; fundición maleable, GJM	< 500				
		K3.2	Hierro fundido con grafito vermicular, GJV; fundición maleable, GJM	> 500				
N	N1	N1.1	Aluminio, aleado y no aleado < 3 % Si		150-600			
		N1.2	Aluminio, aleado ≤ 7 % Si		100-500			
		N1.3	Aluminio, aleado > 7-12 % Si		100-400			
		N1.4	Aluminio, aleado > 12 % Si					
	N2	N2.1	Cobre, no aleado y de baja aleación	< 300	100-350			
		N2.2	Cobre, aleado	> 300	100-300			
		N2.3	Latón, bronce, fundición roja	< 1200	100-250			
	N3	N3.1	Grafito, > 8 μm	< 1200				
		N3.2	Grafito, ≤ 8 μm					
	N4	N4.1	Plástico, termoplásticos					
N4.2		Plástico, plásticos termoestables						
N4.3		Plástico, espumas						
K1+K2	K1.1, K1.2	Mecanizado mixto de hierro fundido (GJL y GJS)						
K+P	K1.1, Sinter	Mecanizado mixto de hierro fundido y acero sinterizado						
N+K	N1.2, K1.1	Mecanizado mixto de aluminio y hierro fundido (GJL)						
	N1.2, K1.2	Mecanizado mixto de aluminio y hierro fundido (GJS)						
N+P	N1.2, Sinter	Mecanizado mixto de aluminio y acero sinterizado						

* Grupos de mecanizado MAPAL

** Si los componentes de aleación de Cr, Mo, Ni, V, W suman > 8 %, elegir el siguiente grupo de mecanizado MAPAL superior.

Metal duro							PCD			
D			Con recubrimiento de PVD, mecanizado mixto				sin revestir	sin revestir		
HP930	HP945	HP950	HP525-P	HP530-P	HP540-P	HP545-P	HU616	PU617	PU660	PU670
	100-180	100-160								
	100-180	100-160								
	100-180	100-160								
	80-150	80-150								
	100-180	100-160								
	80-130	90-130								
	80-130	90-130								
	80-130	90-130								
	80-130	90-130								
	70-120	70-120								
140-220	120-200									
120-200	120-180									
120-180	120-180									
80-140	80-120									
60-130	60-100									
60-120	60-100									
							150-500	450-2200	450-2200	410-1980
							100-450	400-1700	400-1700	360-1530
							100-400	350-1300	350-1300	320-1170
								200-800	200-800	180-720
							100-250	250-600	250-600	230-540
							100-220	200-600	200-600	180-540
							80-220	200-500	200-500	180-450
							120-480	300-600	300-600	270-540
							250-500	400-1000	400-1000	360-900
							250-500	400-1000	400-1000	360-900
			120-220	120-220	120-200					
				120-200	120-200	110-200				
			120-300	120-300	120-230					
			120-280	120-280	120-230					
				120-220	120-230	110-200				

Los valores de trabajo indicados son de referencia.

Los datos óptimos para cada situación de mecanizado deben determinarse mediante ensayos o durante el propio proceso de mecanizado.

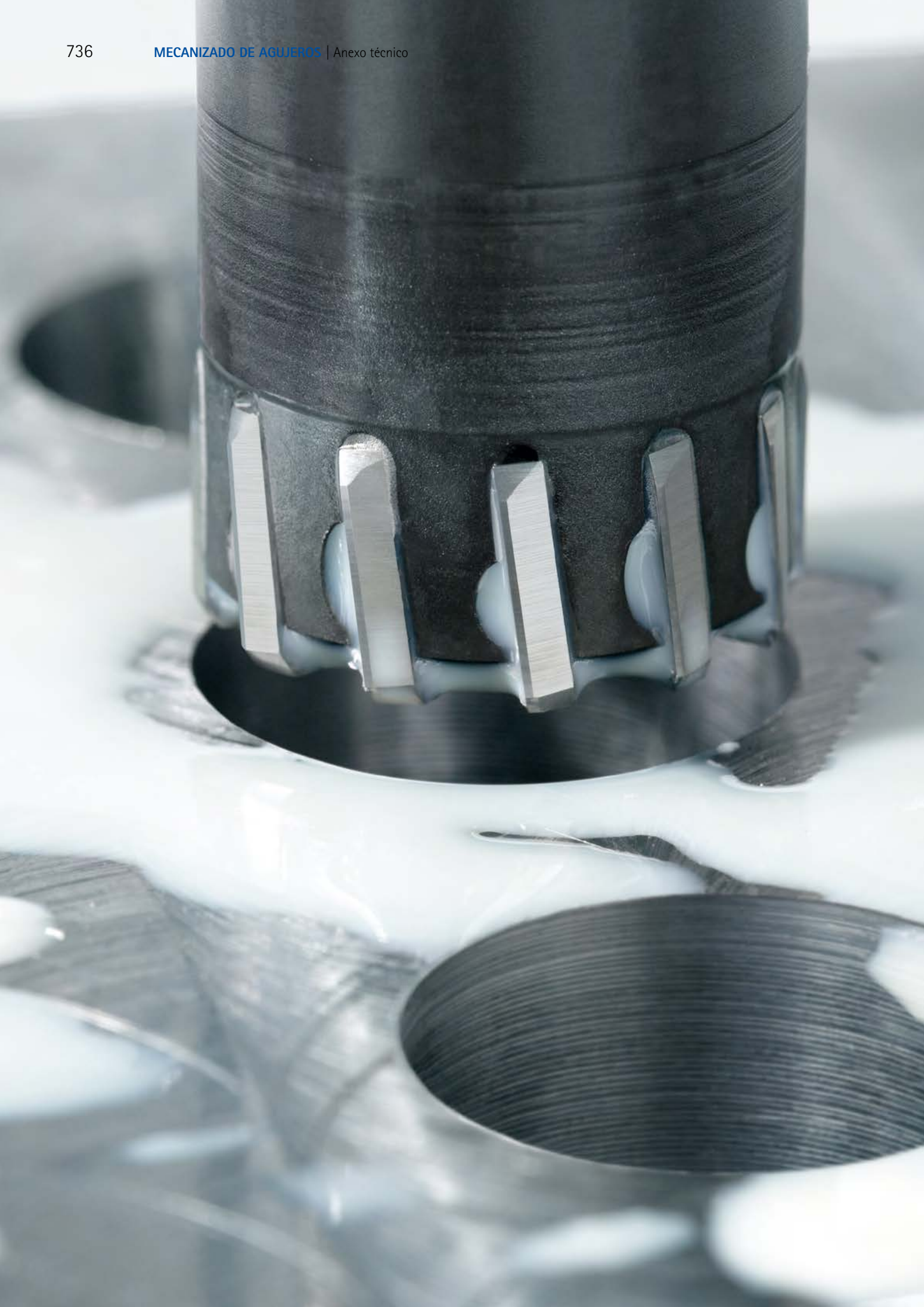

Anexo técnico

Información sobre aplicación, manipulación y datos de corte



59.5
Antriebsauslastung - Anzeige
X1 Y1 Z1 C1 B1 U1
01/07 Service Info
NC/UKS/4_1471_SPM_STANDARDPROG/SPM_2_2
782812_4 MEL 4 Betriebsart aktiv
RESET
UKS
Position [mm]
X 226.533
Y 33.867
Z 46.362
G55 0.000 0.000
TFS
T SPM_STANDARD D1
F SPM_STANDARD 0.000 0.000 1.137.758
S1 Master 0 0 mm/min 0.0% 100%
Zoom Istwert

T.S.M NPV setzen Hulp. Werkst Werkz. messen Position Planfräsen Schwenken

ANEXO TÉCNICO

Barrenado en solido

Indicaciones de uso	
Brocas de cabezal intercambiable TTD-Tritan	740
Taladrado profundo	742
Brocas de insertos de corte	744
Indicaciones de manipulación	
Brocas de placas de corte QTD	746
Brocas de cabezal intercambiable TTD	748
Brocas de cabezal intercambiable TTD-Tritan	750

Escariado y taladrado de precisión

Geometrías de entrada y ángulos de desprendimiento	752
Indicaciones de manipulación	
Sistema HFS	754
HPR400 y HPR400 plus	756
Escariadores de un filo	758
Sistema EasyAdjust	760
Solución de problemas	764

Mandrinado y torneado

Explicación de términos y fórmulas	766
Valores de referencia del diámetro de mandrinado mínimo	770
Solución de problemas	
Formas de desgaste de los insertos de corte	772
De la práctica para la práctica	773

Indicaciones de uso de las brocas de cabezal intercambiable TTD-Tritan

La broca de cabezal intercambiable de tres filos TTD-Tritan garantiza en la unión una transmisión óptima del par y, al mismo tiempo, una elevada precisión de cambio y concentricidad. El cabezal intercambiable puede sustituirse de forma rápida y segura, y no es posible posicionarlo incorrectamente. La herramienta va acompañada de una llave TORX® adecuada con mango para sujetar de forma precisa el cabezal intercambiable en el portaherramientas a través del tornillo de sujeción especial.

Situación del refrigerante

Presión del refrigerante dependiendo de la profundidad de taladrado: 3xD: 8 bar | 5xD: 12 bar



Ángulo de entrada y salida máx.

Para el taladrado piloto y para la salida en superficies inclinadas, reducir v_f un 50 %.

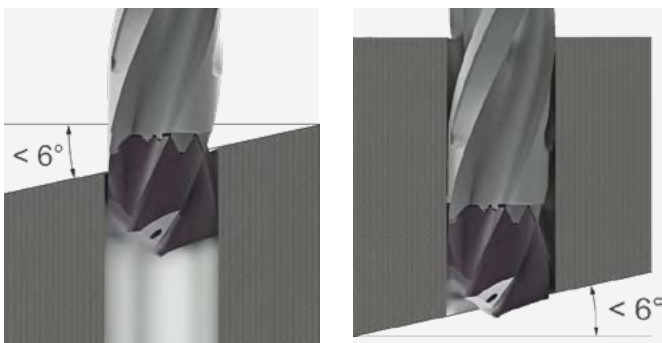

Agujero pasante

Al salir del agujero se recomienda no reducir el valor de corte.

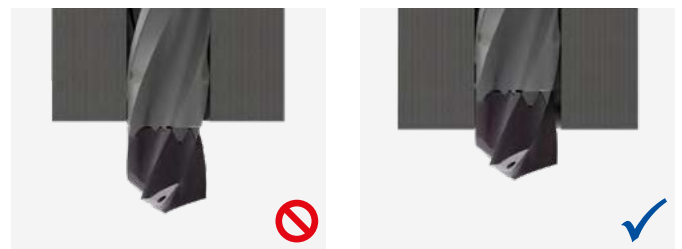

Precisión de concentricidad

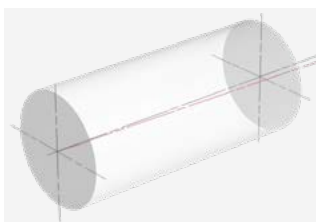

Máx. 0,02 mm

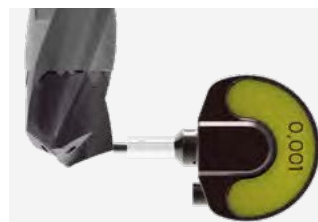

Máx. 0,04 mm

No usar marcha rápida para el retroceso

Para la velocidad de retroceso se recomienda el valor de velocidad de avance multiplicado por cinco.

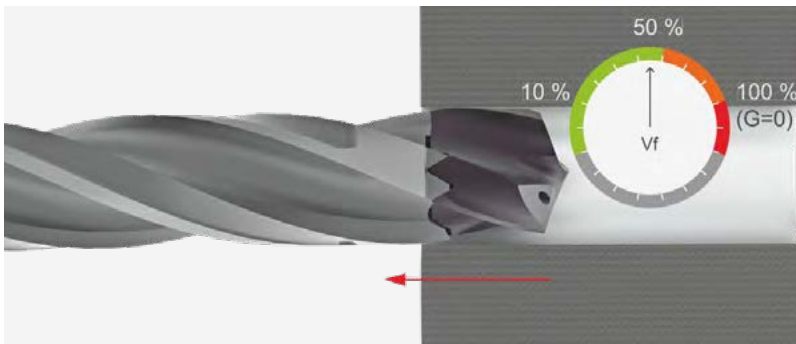

Situaciones de mecanizado

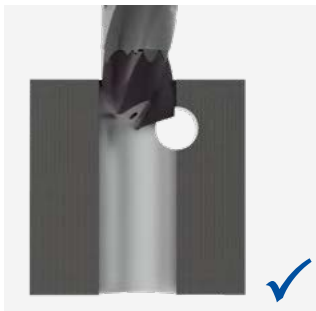

Agujero descentrado
Cuchilla transversal en contacto

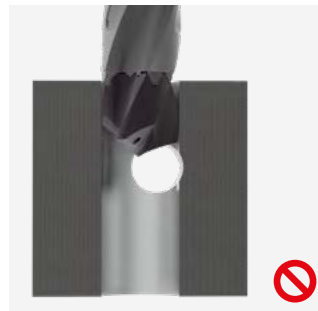

Agujero descentrado
Cuchilla transversal no en contacto

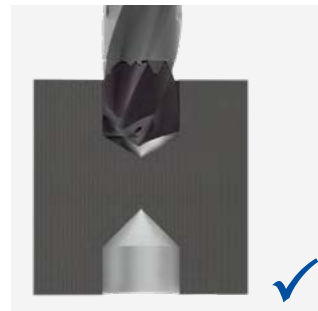

Perforación con agujero en dirección opuesta
 $v_f = -50\%$

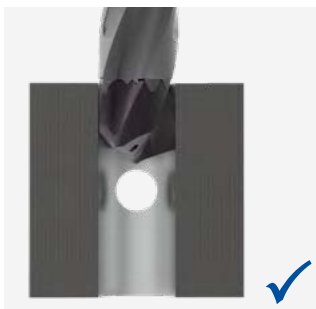

Agujero centrado y $\ll D$



Agujero centrado y $\approx D$



Agujero centrado y $\gg D$

Taladrado profundo

Para MEGA-Deep-Drill | MEGA-Deep-Drill-Alu

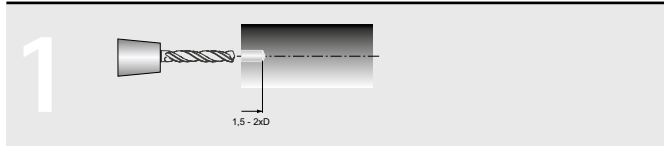

Realizar el agujero piloto

- Recomendación para la broca piloto, véase página siguiente (o 0,01-0,02 mm más grande que el diámetro del taladro profundo)
- Profundidad del agujero piloto entre 1,5 y 2xD

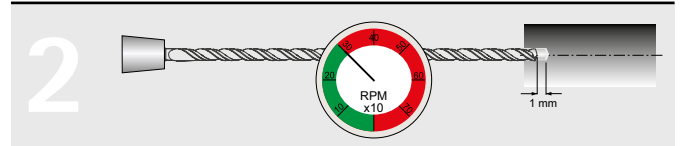

MEGA-Deep-Drill – Entrada en el agujero piloto

- Entrada con máx. 300 r.p.m. y $v_f = 1000$ mm/min
- Sin refrigerante – hasta 1 mm antes del fondo del agujero piloto
- Activar el refrigerante

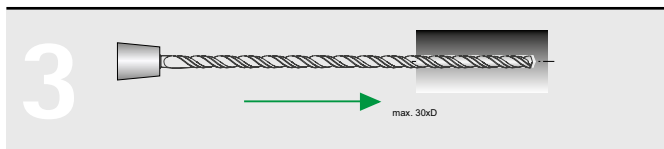

Taladrado con MEGA-Deep-Drill

- Velocidad de corte (v_c) y avances (f) según la tabla (véase la página 286). Taladrado sin ciclos de picoteo

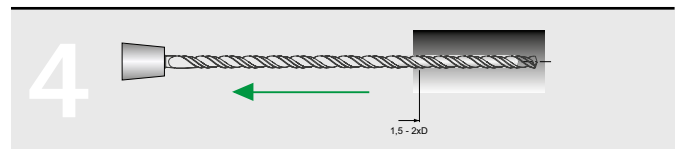

MEGA-Deep-Drill – Retroseso

- Retroseso con el número de revoluciones actual y avance doble (= $2 \times v_f$) hasta 1,5-2xD al final del agujero

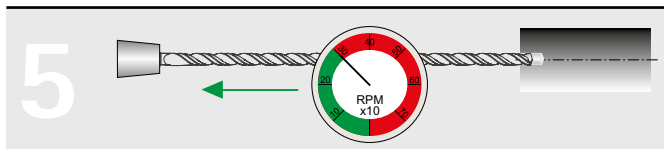

MEGA-Deep-Drill – Salida del agujero

- Desactivar el refrigerante
- Salida con máx. 300 r.p.m. y $v_f = 1000$ mm/min

Indicaciones de uso para diámetro ≤ 3 mm

- Selección de un tipo de refrigerante adecuado para herramientas muy pequeñas para una óptima lubricación por refrigeración
- Filtración eficaz del medio refrigerante para evitar la obstrucción de los canales de refrigeración
- Selección de un ciclo de taladrado adecuado (taladrado con ciclos de picoteo si es necesario)

Presión del refrigerante necesaria

Para MEGA-Deep-Drill | MEGA-Deep-Drill-Alu

	ø 3 – 5 mm	ø 5 – 8 mm	ø 8 – 12 mm	ø 12 – 16 mm
RI	60 bar	40 bar	30 bar	25 bar
MMS	12 bar	10 bar	9 bar	8 bar

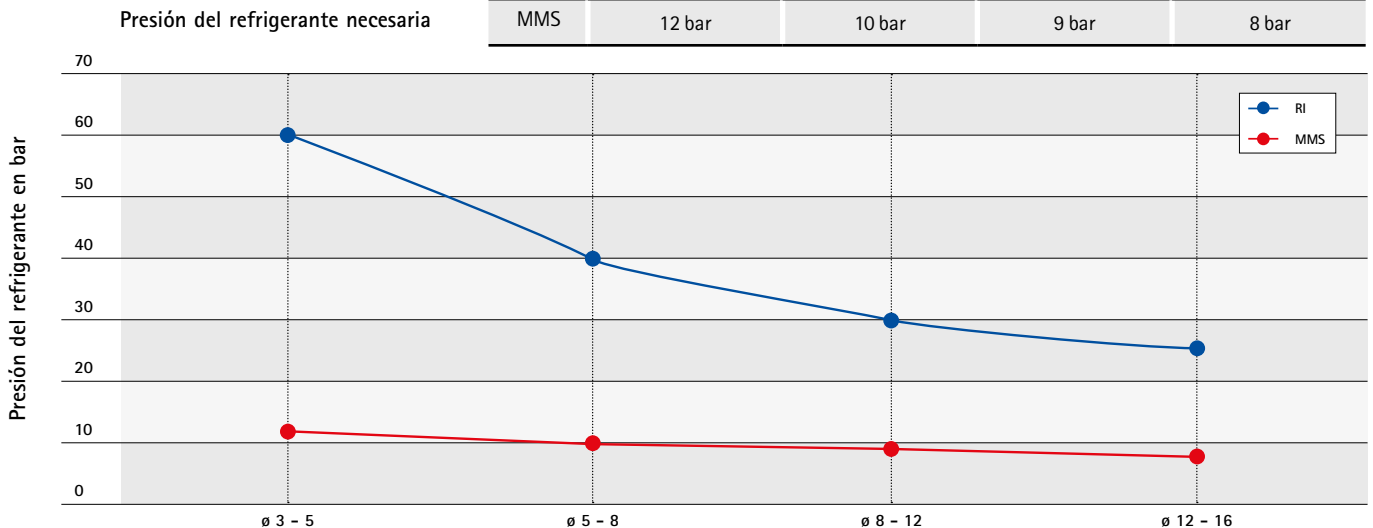

Taladrado profundo 15xD – 30xD en dos pasos:

Taladrado profundo 15xD – 30xD con MEGA-Deep-Drill (SCD171) o MEGA-Deep-Drill-Alu (SCD181)

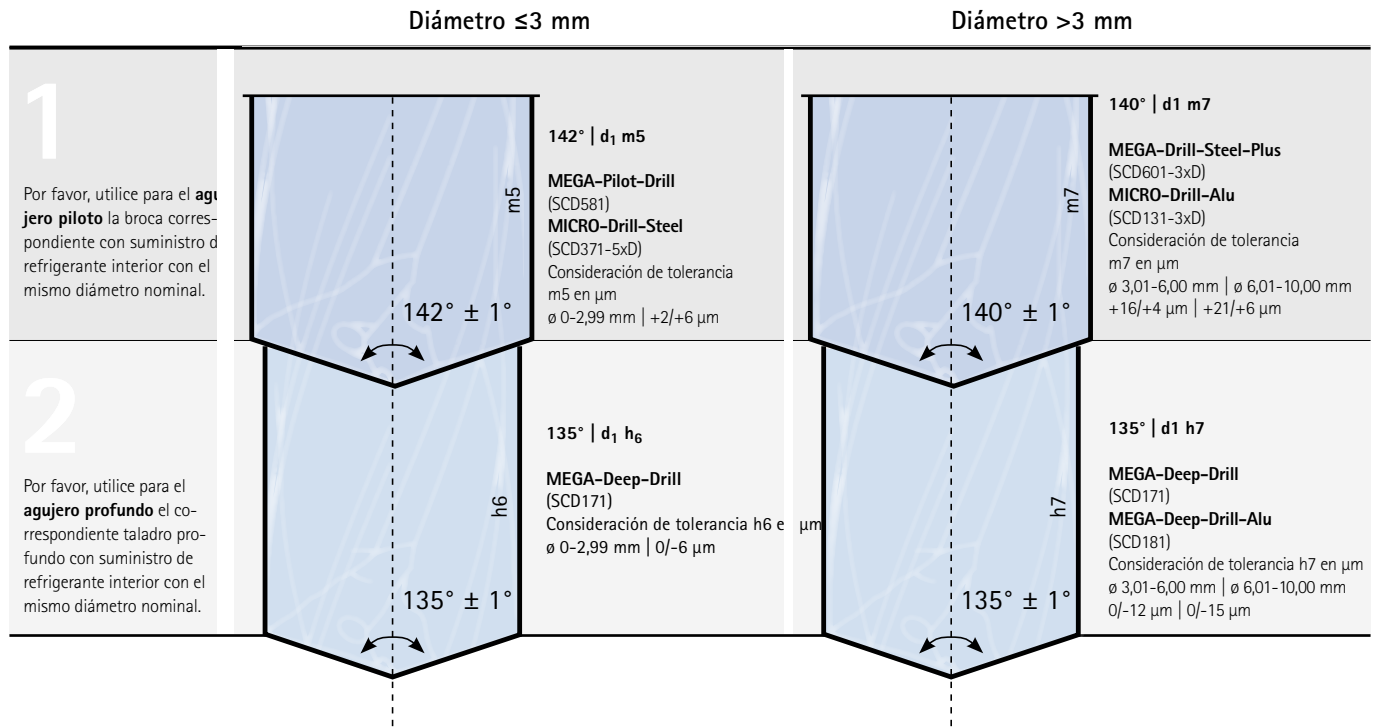

Taladrado profundo 40xD en tres pasos:

Taladrado profundo 40xD con MEGA-Deep-Drill (SCD171) o MEGA-Deep-Drill-Alu (SCD181)

Diseño óptimo para un mecanizado seguro.

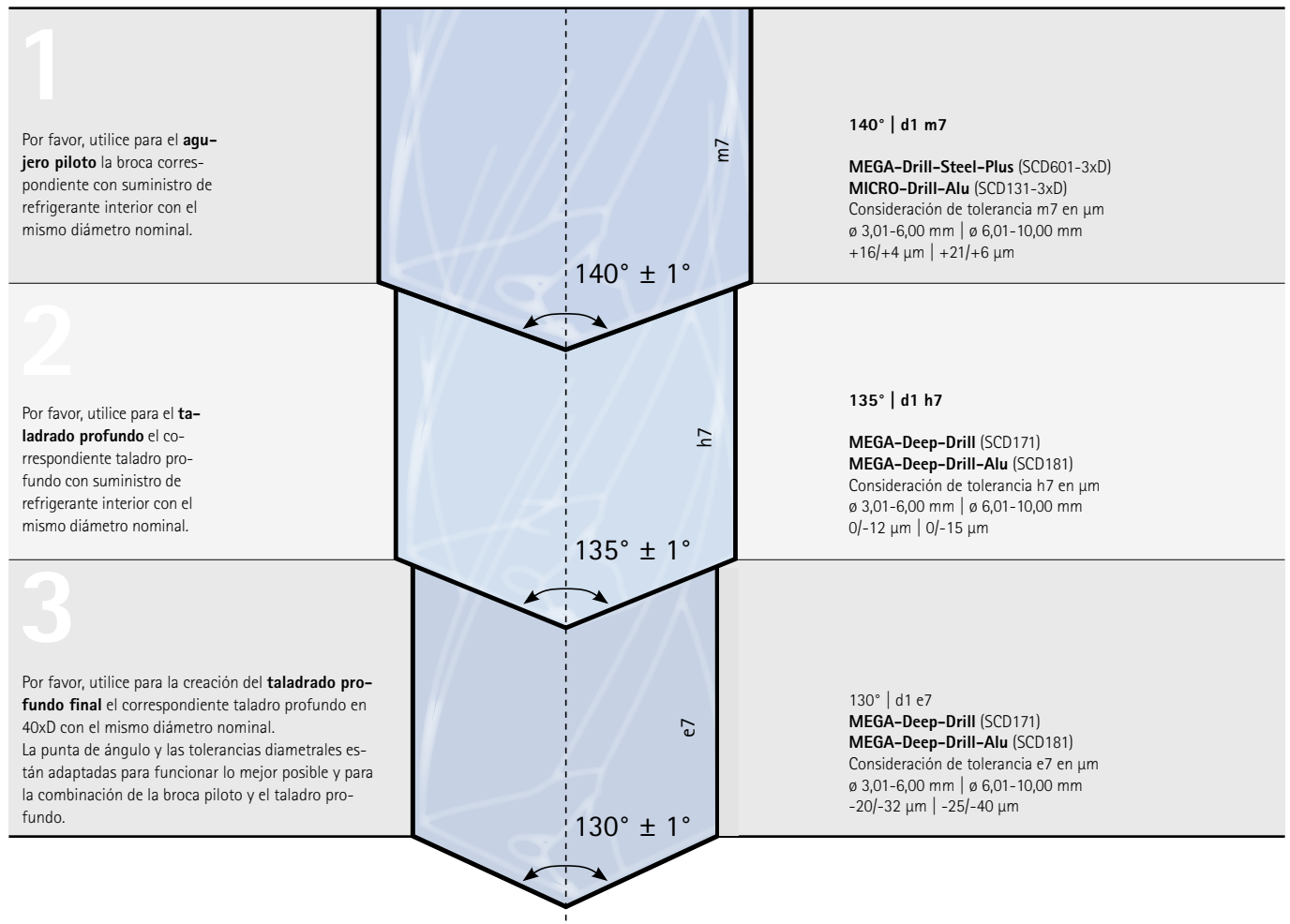

Indicaciones de aplicación para broca con insertos de corte

NOTAS

- Longitud máxima de herramienta 5xD
- En el caso de utilizar brocas con una relación longitud/diámetro superior a tres, durante el taladrado piloto y al salir la broca se recomiendan las siguientes reducciones con respecto a la velocidad de corte v_c y al avance f:
 - 3xD: v_c -20 % | f -30 %
 - 4xD: v_c -30 % | f -40 %
 - 5xD: v_c -40 % | f -50 %



Lo ideal es que la situación de la rosca sea plana, avellanada o prefresada.

Si no es el caso, es necesaria una reducción del avance de entre un 30 y un 60 %:

- Taladrado y salida de la broca en superficies inclinadas y cóncavas
- Al entrar la broca en agujeros transversales
- Agujeros en materiales apilados
- Taladrado piloto en superficies irregulares
- Taladrado piloto en un borde
- Taladrado piloto en una superficie abombada
- Taladrado piloto en un contorno puntiagudo
- Agujeros en fila con solapamientos
- Taladrado piloto de un centraje
- Un mandrinado no es posible



Taladrado de paquetes



Taladrado piloto de una superficie abombada



Taladrado pasante con agujero transversal



Taladrado piloto de un contorno puntiagudo



Taladrado piloto en una superficie irregular

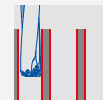

Unos agujeros en fila son posibles con restricciones en función del material



Taladrado piloto en un borde



Taladrado piloto de un centraje o una acanaladura



Taladrado piloto de superficies inclinadas/salida inclinada del agujero



Un mandrinado no es posible

Topografía en el fondo del agujero en agujeros ciegos

	Diámetro D [mm]	A* [mm]	B* [mm]	C* [mm]
WOGT030206N-X40-HC698	16,00 - 20,90	3,61 (con \varnothing 16) - 3,52 (con \varnothing 20,9)	3,89 (con \varnothing 16) - 6,93 (con \varnothing 20,9)	0,40 (con \varnothing 16) - 0,71 (con \varnothing 20,9)
WOGT040206N-X40-HC698	21,00 - 25,90	4,06 (con \varnothing 21) - 4,00 (con \varnothing 25,9)	6,44 (con \varnothing 21) - 8,95 (con \varnothing 25,9)	0,76 (con \varnothing 21) - 0,98 (con \varnothing 25,9)
WOGT053006N-X40-HC698	26,00 - 30,90	5,18 (con \varnothing 26) - 5,11 (con \varnothing 30,9)	7,82 (con \varnothing 26) - 10,34 (con \varnothing 30,9)	0,81 (con \varnothing 26) - 1,04 (con \varnothing 30,9)
WOGT063008N-X40-HC698	31,00 - 44,90	6,41 (con \varnothing 31) - 6,28 (con \varnothing 44,9)	9,09 (con \varnothing 31) - 16,18 (con \varnothing 44,9)	1,06 (con \varnothing 31) - 1,62 (con \varnothing 44,9)
WOGT073808N-X40-HC698	45,00 - 54,90	7,70 (con \varnothing 45) - 7,63 (con \varnothing 54,9)	14,80 (con \varnothing 45) - 19,82 (con \varnothing 54,9)	1,57 (con \varnothing 45) - 7,63 (con \varnothing 54,9)

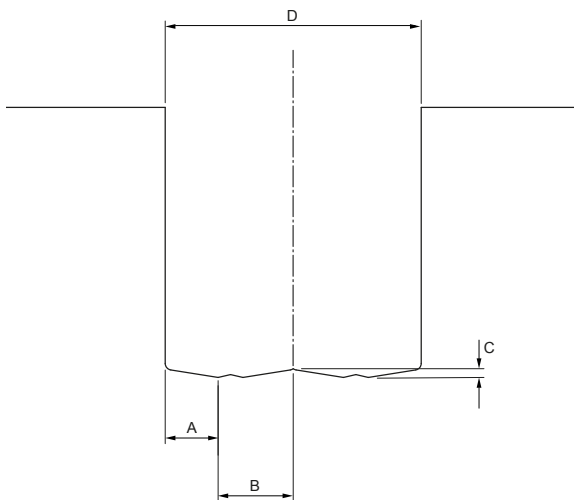
**Nota de seguridad**

En los agujeros pasantes, al salir la broca se desprende una tapa de aristas vivas o un disco del agujero. Existe peligro de que este disco salga despedido, causando daños o lesiones. Con el fin de evitarlo deberán adoptarse las medidas de protección correspondientes.

*Debido a la posición de montaje y al ángulo de incisión de las placas de corte varían A, B y C.

Información de manipulación para brocas de placas de corte QTD

Cambio y ajuste fáciles de los insertos QTD

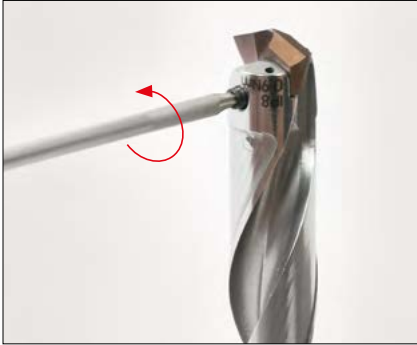

1. Afloje el tornillo de sujeción especial girando en sentido antihorario con ayuda de la llave TORX® PLUS suministrada.



2. Extraiga la placa de corte del asiento de placa.



3. Limpie el asiento de placa con aire comprimido.

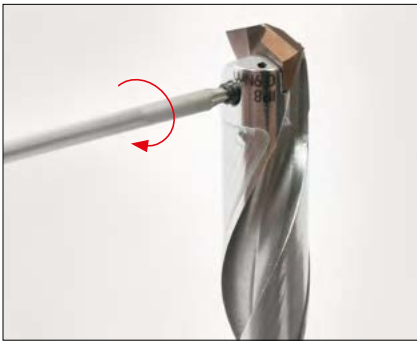

4. Coloque la nueva placa de corte en el asiento de placa. Apriete manualmente el tornillo de sujeción especial girando en sentido horario, utilizando la llave TORX® PLUS suministrada.



5. Apriete el tornillo de sujeción especial con el par de apriete especificado.

NOTAS

- ¡Utilice exclusivamente los tornillos originales!
- A más tardar en el 5.º cambio del cabezal de taladrado debe sustituirse el tornillo de sujeción especial
- En la herramienta está grabado el par de apriete válido

Resultado:

La placa de corte se ha sustituido completamente y la herramienta puede utilizarse.



Notas

Información de manipulación de la broca de cabezal intercambiable TTD

Información práctica

PILOTAJE

- A partir de una profundidad de taladrado de 8xD se recomienda un agujero piloto
- Para el cabezal de taladrado intercambiable tipo 02 se recomienda un agujero piloto a partir de una profundidad de taladrado de 5xD
- Para un agujero piloto con el cabezal de taladrado intercambiable tipo 02 se recomienda una reducción del avance indicado en un 50 %
- Para un agujero piloto con los cabezales de taladrado intercambiables de los tipos 01 y 03 pueden utilizarse los valores de trabajo recomendados
- La entrada en el agujero piloto se realiza con la misma geometría del cabezal de taladrado y unos valores de trabajo reducidos (recomendación: $v_c = 50 \%$ y aprox. $f = 50 \%$) hasta 1 mm antes del fondo del agujero
- El taladrado después del pilotaje se realiza con los valores de trabajo recomendados (véanse las páginas 224-227)

Herramienta parada

Con la herramienta parada, posicionar horizontalmente la salida del espacio para virutas para que no se estanquen las virutas.

Situación del refrigerante

Presión del refrigerante dependiendo de la profundidad de taladrado:

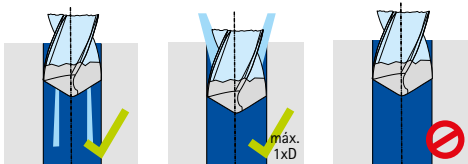

1xD: 8 bar | 3xD: 8 bar | 5xD: 12 bar | 8xD: 25 bar | 12xD: 40 bar

Ángulo de entrada y de salida máx.

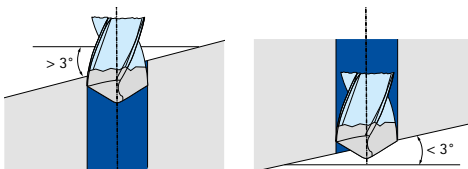

INFORMACIÓN PARA EL TALADRADO CON SOPORTE 12xD

- Con una profundidad de taladrado de 12xD es necesario un agujero piloto
- La presión del refrigerante debe ser de 40 bar, como mínimo
- Para el mecanizado de materiales de acero puede ser necesario eliminar las virutas
- Con una herramienta accionada es posible el uso en el torno
- Se recomienda aumentar la velocidad de corte un 30 % respecto al valor estándar

Agujero pasante

Al salir del agujero se recomienda no realizar ninguna reducción del valor de corte.

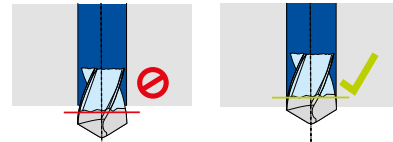

Precisión de concentricidad

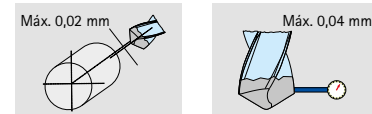

No usar marcha rápida para el retroceso

Para la velocidad de retroceso se recomienda el valor de la velocidad de avance multiplicado por cinco.

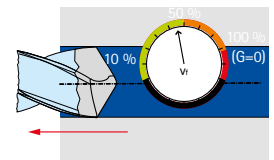

Situaciones de mecanizado



Agujero descentrado
Cuchilla transversal en contacto

Agujero descentrado
Cuchilla transversal no en contacto

Perforación con agujero en
dirección opuesta

Agujero centrado
 $y < D$

Agujero centrado
 $y = D$

Agujero centrado
 $y >> D$

Montaje

Aflojar el cabezal de taladrado

1. En cada sustitución del cabezal de taladrado, compruebe la facilidad de movimiento del tornillo de sujeción. Si el tornillo de sujeción puede aflojarse fácilmente, debe sustituirse. ¡Utilice exclusivamente los tornillos de sujeción originales!

Nota:

Como muy tarde al cambiar por 8.ª vez el cabezal de taladrado, es necesario sustituir el tornillo de sujeción.



2. Abra el tornillo de sujeción utilizando la llave para tornillos de cabeza hexagonal suministrada.



3. Extraiga el cabezal de taladrado del dentado.

Sujetar el cabezal de taladrado

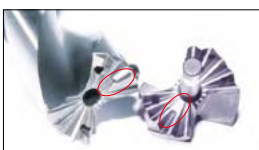

1. Limpie con un cepillo la unión TTS del soporte.
2. Coloque el nuevo cabezal de taladrado en el soporte.
3. Apriete el tornillo de sujeción manualmente en sentido horario.

Nota:

Compruebe que la ayuda de posicionamiento del cabezal de taladrado esté en contacto con la ayuda de posicionamiento del soporte, y que coincidan la ranura de alojamiento de virutas y el dentado del cabezal de taladrado y del soporte.

Pares de apriete del tornillo de apriete

Rango de diámetros [mm]	Rosca Portaherramientas para cabezal intercambiable	Anchura de los pisos	Par de apriete admisible que puede transmitirse [Nm]
12,00 - 13,49	M2,5	1,3	1,0
13,50 - 16,49	M3	1,5	1,3
16,50 - 24,49	M4x0,5	2	3,5
24,50 - 32,49	M5x0,5	2,5	4,0
32,50 - 41,49	M6x0,5	3	6,0
41,50 - 45,49	M8x1	4	10,0

Indicaciones de manipulación de la broca de cabezal intercambiable TTD-Tritan

Montaje de la herramienta

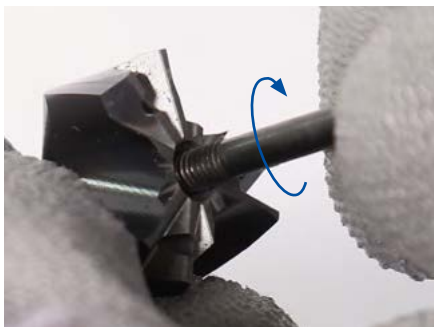

- 1. Introducir y enroscar el tornillo de sujeción especial**
Introducir el tornillo de sujeción especial en el agujero del cabezal de taladrado intercambiable, con el lado roscado pequeño delante. A continuación, enroscar el tornillo de sujeción especial en sentido horario hasta el tope.



- 2. Limpieza con aire comprimido**
Limpiar con aire comprimido el portaherramientas para cabezal intercambiable y el cabezal de taladrado intercambiable.

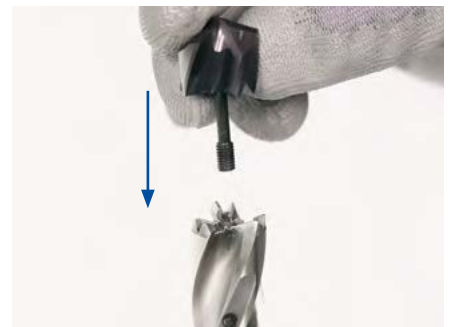

- 3. Colocar el cabezal de taladrado intercambiable**
Colocar el cabezal de taladrado intercambiable en el portaherramientas para cabezal intercambiable.

Nota:

En el estado de suministro, el tornillo de sujeción especial ya está montado en el cabezal de taladrado intercambiable. Una vez aflojado, el tornillo de sujeción especial puede volver a enroscarse en el cabezal de taladrado intercambiable.

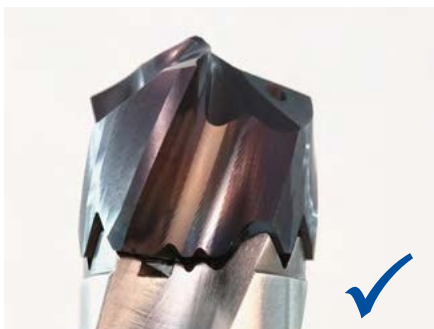

- 4. Comprobar el posicionamiento del cabezal de taladrado**
Comprobar si coinciden las ranuras de alojamiento de virutas y los dentados del cabezal de taladrado intercambiable y del portaherramientas para cabezal intercambiable. Si no coinciden, girar el cabezal de taladrado intercambiable hasta que coincidan la ranura de alojamiento de virutas y el dentado.

Resultado:

La ranura de alojamiento de virutas y el dentado coinciden (izquierda) | no coinciden (derecha)

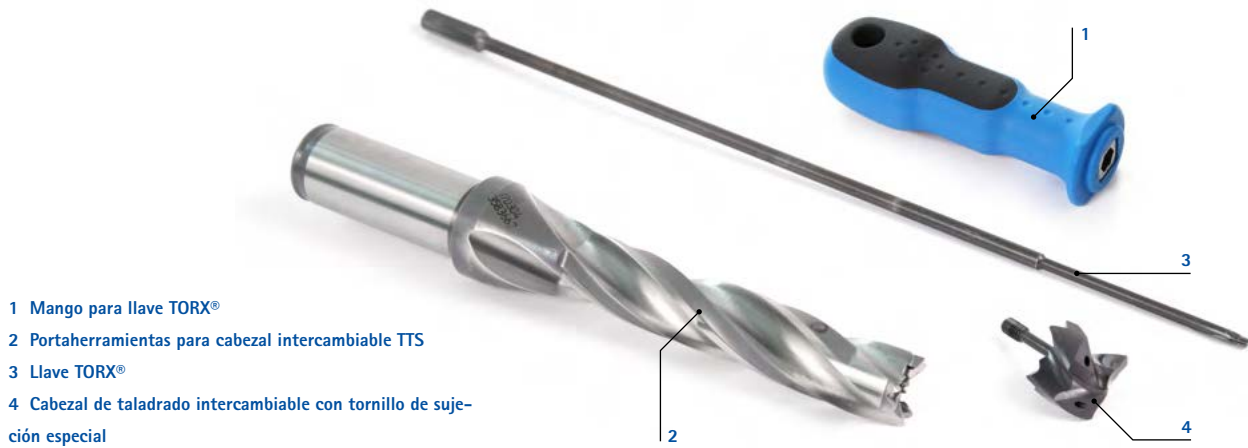

- 1 Mango para llave TORX®
- 2 Portaherramientas para cabezal intercambiable TTS
- 3 Llave TORX®
- 4 Cabezal de taladrado intercambiable con tornillo de sujeción especial



5. **Apretar hasta el tope el tornillo de sujeción especial**
Mantener ligeramente apretado el cabezal de taladrado intercambiable contra el portaherramientas para cabezal intercambiable para que se mantenga en la posición ajustada. A continuación, introducir la llave TORX® en el agujero central del portaherramientas para cabezal intercambiable, hasta el orificio roscado del tornillo de sujeción especial. Después, apretar a mano el tornillo de sujeción especial con la llave TORX® hasta el tope en sentido antihorario.



6. **Apretar el tornillo de sujeción especial con el par de apriete**

Utilizando una llave dinamométrica adecuada con punta Allen, apretar el tornillo de sujeción especial en combinación con la llave TORX® y el par de apriete especificado.

Nota:

El par de apriete especificado del tornillo de sujeción especial está indicado en el lado inferior del portaherramientas para cabezal intercambiable.

Resultado:

El tornillo de sujeción especial está apretado con el par de apriete especificado y el cabezal de taladrado intercambiable está firmemente unido al portaherramientas para cabezal intercambiable. El proceso de montaje ha concluido.

Volumen de suministro

- 1 Mango para llave TORX®
- 2 Portaherramientas para cabezal intercambiable TTS
- 3 Llave TORX®

Pares de apriete del tornillo de sujeción especial

Rango de diámetros [mm]	Rosca Portaherramientas para cabezal intercambiable	Tamaño TORX®	Par de apriete admisible que puede transmitirse [Nm]
12,00 - 13,99	M3 x 0,5	T6	0,40
14,00 - 17,49	M3,5 x 0,6	T7	0,70
17,50 - 19,49	M4 x 0,7	T8	1,30
19,50 - 24,49	M5 x 0,8	T10	2,00
24,50 - 28,49	M6 x 1,0	T15	3,10
28,50 - 32,49	M6 x 1,0	T15	5,60

Geometrías de entrada y ángulos de desprendimiento

Escariador de múltiples filos

Series FXR, MOR, MPR, HPR

Entrada

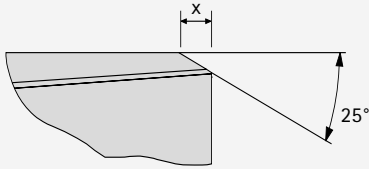
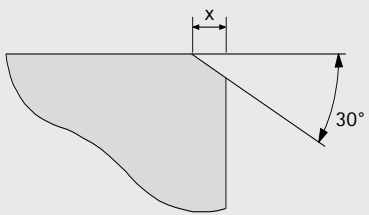
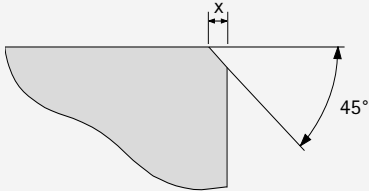
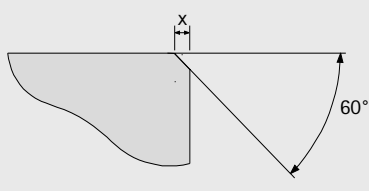
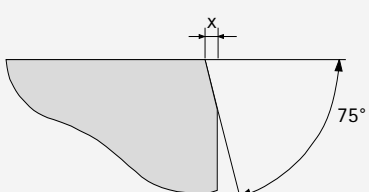
Geometría	Geometría de entrada	
	Denominación	Geometría
	ML	25°
	ME	30°
	MF	
	MG	
	MY	
	MC	45°
	MO	
	MU	
	MV	60°
	MT	
	MA	75°

Forma de viruta/ángulo de desprendimiento

Ángulo de desprendimiento	
Denominación	Ángulo
0A	0°
1 F	5°
1G	6°
1M	13°
2A	0° (para agujero ciego)
2G	6° (para agujero ciego)
3C	-2°

Explicación de los materiales de corte	
Denominación	Explicación
HU	Metal duro sin recubrimiento
HP	Metal duro con recubrimiento de PVD
HC	Metal duro con recubrimiento CVD
CU	Cermet sin recubrimiento
CP	Cermet con recubrimiento de PVD
PU	PCD

x = Longitud de la entrada

Resumen de la serie | Rango de diámetros | Designación de entrada | Longitud de la entrada

Serie	Designación de entrada	Rango de diámetros	Longitud de la entrada x
FXR	MC	2,81 - 3,35	0,30
		3,36 - 4,05	0,40
		4,06 - 5,60	0,50
		5,61 - 6,60	0,60
		6,61 - 7,60	0,70
		7,61 - 11,60	0,80
		11,61 - 20,10	1,00
	MF	2,81 - 3,70	0,70
		3,71 - 6,20	0,90
		6,21 - 12,20	1,20
		12,21 - 20,20	1,50
	MG	2,81 - 3,70	0,70
		3,71 - 6,20	0,90
		6,21 - 12,20	1,20
		12,21 - 20,20	1,50
	MT	2,81 - 6,20	0,30
		6,21 - 10,70	0,40
		10,71 - 16,20	0,50
		16,21 - 20,20	0,60
	MV	2,81 - 6,20	0,30
		6,21 - 10,70	0,40
		10,71 - 16,20	0,50
		16,21 - 20,20	0,60

Serie	Designación de entrada	Rango de diámetros	Longitud de la entrada x
MOR	MY	7,70 - 40,20	1,00
	MU	7,70 - 40,20	0,60
MRP	MG	3,85 - 6,20	0,90
		6,21 - 10,70	1,20
		10,71 - 20,20	1,50
		20,21 - 40,20	1,50
	MV	3,85 - 6,20	0,30
		6,21 - 10,70	0,40
		10,71 - 20,20	0,50
		20,21 - 26,20	0,60
	26,21 - 40,20	0,80	
HPR	MA	7,00 - 65,00	0,40
	MC	7,00 - 65,00	0,55
	ME	7,00 - 65,00	1,40
	MF	7,00 - 65,00	1,40
	ML	7,00 - 65,00	1,00
	MO	7,00 - 65,00	0,60

Información de manipulación para sistema HFS®

Sistema HFS® de MAPAL con sujeción axial

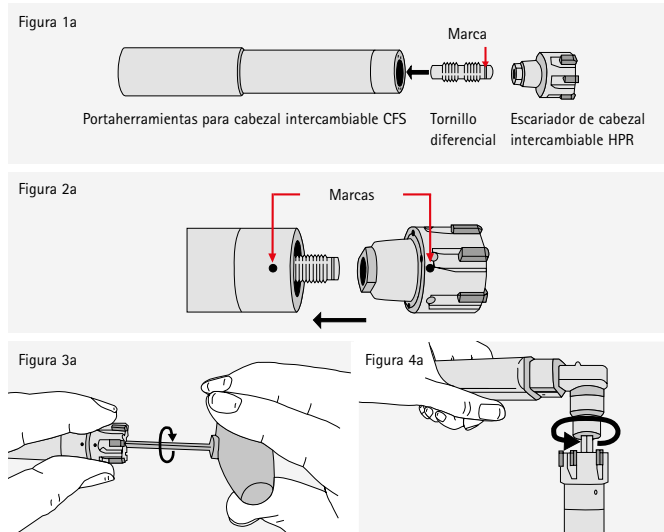

Sistema HFS® de MAPAL con sujeción radial

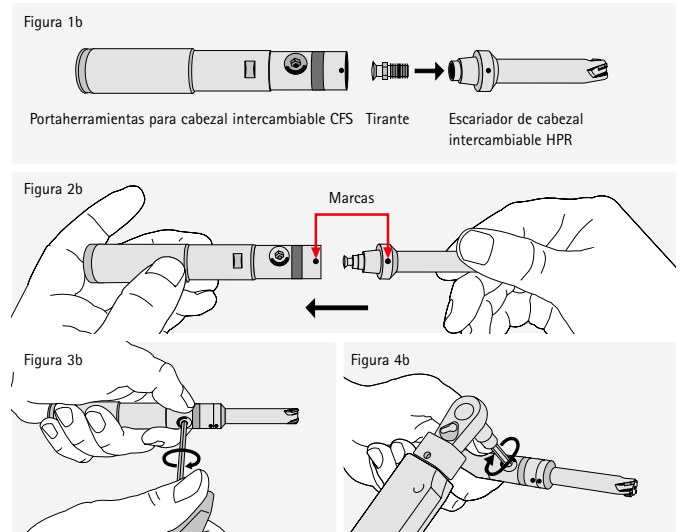

Limpieza

Limpiar todas las piezas y prestar atención a que los conos interior y exterior, así como la cara plana del cono HFS, estén libres de cuerpos extraños (p. ej., virutas). Para la limpieza del cono interior se recomienda el limpiador cónico especial (véase la página 474).

Sujeción

- Colocar el extremo del tornillo diferencial sin marca en el portaherramientas para cabezal intercambiable HFS sin enroscar el tornillo diferencial (véase Fig. 1a).
- Colocar el escariador de cabezal intercambiable HPR en el tornillo diferencial. A la vez, alinear las marcas del escariador de cabezal intercambiable HPR y del portaherramientas para cabezal intercambiable HFS: «punto con punto» (véase Fig. 2a). A continuación, colocar el escariador de cabezal intercambiable HPR completamente en el portaherramientas para cabezal intercambiable HFS y sujetar ambas piezas.
- Atornillar el escariador de cabezal intercambiable HPR y el portaherramientas para cabezal intercambiable HFS con una llave Allen y apretar firmemente. Prestar atención a que estén alineadas las marcas y a que la cara plana esté en contacto (véase Fig. 3a).
Nota: HPR 100, 110, 150 se aprietan a través del escariador (sentido de giro en sentido horario). HPR 130, 131, 180 se aprietan a través del portaherramientas (sentido de giro en sentido antihorario). Los sentidos de giro vienen indicados en el portaherramientas.
- Nota:** Los portaherramientas para cabezal intercambiable HFS están rotulados con el par de apriete requerido. Apretar el escariador de cabezal intercambiable HPR con la llave dinamo-métrica en sentido horario (véase Fig. 4a).

Soltar

- Nota:** El sentido de giro para soltar el escariador de cabezal intercambiable HPR es opuesto al sentido de giro del proceso de sujeción. Para soltar el escariador de cabezal intercambiable HPR, girar el tornillo diferencial con una llave Allen.
- Extraer el escariador de cabezal intercambiable HPR.

Ajuste del escariador de cabezal intercambiable HPR con ajuste de precisión

- Nota:** El par de insertos opuesto en línea con los puntos de marca redondos en el portaherramientas para cabezal intercambiable HFS y en el escariador de cabezal intercambiable HPR, se utilizan como referencia para la medición y el ajuste del diámetro de la herramienta. Fijar el escariador de cabezal intercambiable HPR en el portaherramientas para cabezal intercambiable HFS.
- Ajustar el diámetro deseado de la herramienta mediante el micrómetro con cuadrante indicador. A continuación, situar el micrómetro con cuadrante indicador en los filos de referencia.
- Situación la llave TORX® en el tornillo de ajuste y girar lentamente en sentido horario. Ajustar el escariador de cabezal intercambiable HPR a la medida deseada.



Por favor, observe en variantes HPR con sistema de ajuste:

En los escariadores de cabezal intercambiable HPR de ajuste de precisión hasta \varnothing 30 mm y un tamaño HFS 12 hasta 20, una sujeción del escariador de cabezal intercambiable HPR solo es posible radialmente. A partir de un \varnothing 30 mm y un tamaño HFS 24, el escariador de cabezal intercambiable HPR también puede sujetarse a través del tornillo diferencial.

Sujeción

- Enroscar el tirante con el lado roscado en el escariador de cabezal intercambiable HPR con rosca izquierda (véase Fig. 1b).
- Colocar el escariador de cabezal intercambiable HPR completamente en el portaherramientas para cabezal intercambiable HFS. A la vez, alinear las marcas del escariador de cabezal intercambiable HPR y del portaherramientas para cabezal intercambiable HFS: «punto con punto» (véase Fig. 2b). A continuación, sujetar ambas piezas.
- Girar el perno de sujeción con la llave Allen en sentido horario (véase Fig. 3b). El sentido de giro viene indicado en el portaherramientas para cabezal intercambiable HFS.
- Nota:** Los portaherramientas para cabezal intercambiable HFS están rotulados con el par de apriete requerido. Apretar el escariador de cabezal intercambiable HPR con la llave dinamo-métrica en sentido horario (véase Fig. 4b).

Tamaño de interfaz HFS	Par de apriete [Nm]	
	axial	radial
10	4	-
12	6	7
14	6	7
16	15	12
20	15	12
24	20	-

Soltar

- Para soltar el escariador, girar el perno de sujeción con una llave Allen hasta el tope en sentido antihorario.
→ El escariador de cabezal intercambiable HPR se expulsa y puede extraerse.

Conducción del refrigerante para el sistema HFS®

Para aprovechar completamente el elevado rendimiento de los escariadores HPR, las diferentes series de cabezales intercambiables requieren la conducción de refrigerante adecuada. La diferencia entre los componentes reside en el tornillo diferencial o el tirante. Dependiendo de la variante de cabezal, estos componentes se utilizan con o sin paso del refrigerante para garantizar una conducción directa del refrigerante a través de la unión directamente hasta los insertos.

Nota:

En todos los portaherramientas con tamaño HFS 12 siempre se incluyen ambas ejecuciones en el volumen de suministro. Por este motivo, durante el montaje es importante seleccionar el sistema adecuado para el cabezal intercambiable (véase Fig. abajo)

Conducción del refrigerante sin paso central

Los escariadores tienen que montarse sin paso central del refrigerante.

El refrigerante se transfiere a través de la cara plana del portaherramientas al cabezal intercambiable.

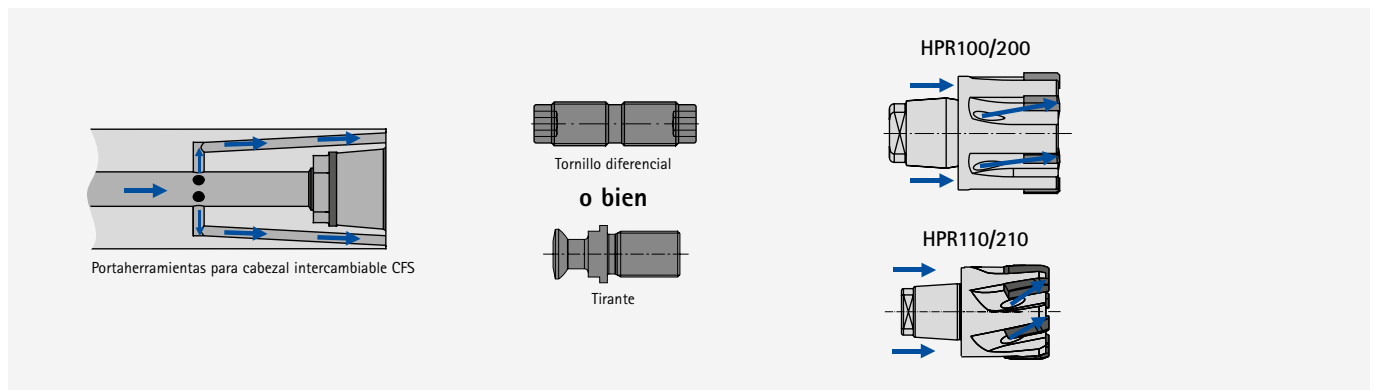

Conducción del refrigerante con paso central

Todos los escariadores indicados deben montarse con paso central del refrigerante.

El refrigerante se transfiere de forma central y, en el caso de HPR150 y HPR250, adicionalmente a través de la cara plana.

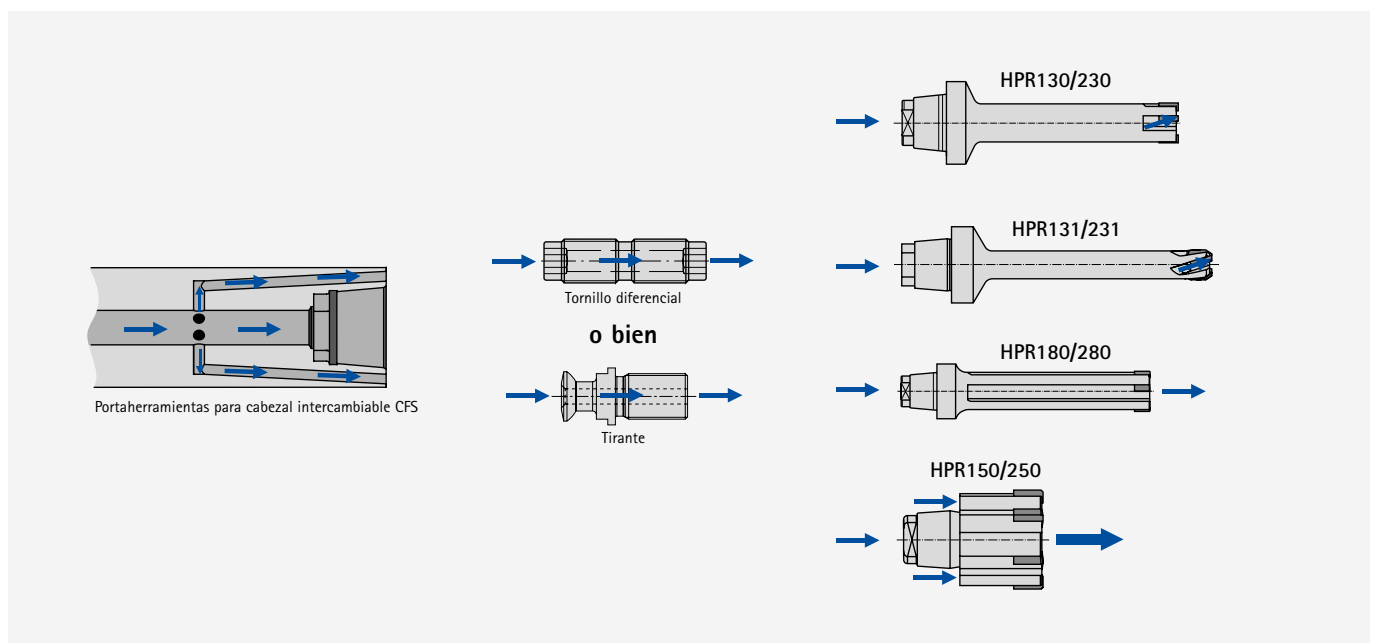

Información de manipulación del HPR400

El HPR400 ofrece un sistema en el que la herramienta puede reequiparse de forma rápida y económica directamente en las instalaciones del cliente. Las placas de corte sustituibles se colocan axialmente en el asiento de placa de corte y, con ayuda de un tornillo TORX®, se fijan de forma estable en el cuerpo de la herramienta. La calidad de mecanizado de precisión micrométrica se mantiene como de costumbre.

Cambio de las placas de corte

Nota:

¡Durante el cambio de placas de corte deben sustituirse completamente todas las placas de corte!



1. Limpiar el HPR400 con aire comprimido y un paño. Soltar el tornillo TORX®. A tal efecto, girar el tornillo TORX® con un destornillador TORX® adecuado en sentido antihorario. Después de soltarlo, extraer el tornillo TORX®.



2. Desplazar la placa de corte cuidadosamente en sentido axial hacia fuera del asiento de la placa de corte y extraerla. Extraer las demás placas de corte repitiendo los pasos 1 y 2.



Observación:

Solo para personal cualificado.

3. **Nota:** en caso de suciedad, limpiar las superficies de apoyo de las placas de corte.

Limpiar los asientos de placa de corte con aire comprimido. A continuación, limpiar los asientos de placas aplicando alcohol de limpieza de la forma adecuada.



4. Colocar la placa de corte nueva hasta la mitad del asiento de placa de corte. A continuación, presionar la placa de corte con el dedo pulgar ligeramente dentro del asiento de placa de corte y, al mismo tiempo, desplazar la placa de corte axialmente hacia abajo hasta la posición final.

Para evitar que se caiga la placa de corte, fijar la placa de corte con el tornillo TORX®.



5. **Nota:** apretar los tornillos TORX® únicamente con una llave dinamométrica adecuada.

Apretar el tornillo TORX® con un par de apriete de 3,1 m.

Resultado:

Las placas de corte están completamente cambiadas y el HPR400 está listo para usarse.

Indicaciones de manipulación de HPR400 plus

Las placas de corte de cuatro filos del HPR400 plus se fabrican con una precisión tan elevada que los empleados del cliente pueden, como hasta ahora, invertir o cambiar las placas de corte sin problemas.



Cambio de las placas de corte

Requisito:

Limpiar la herramienta antes de iniciar el cambio de las placas de corte.

Observación:

Solo para personal cualificado.



1. Aflojar el tornillo TORX® PLUS con un destornillador adecuado, girar a tal efecto el tornillo TORX® PLUS en sentido antihorario. A continuación, extraer el tornillo TORX® PLUS.



2. Desplazar la placa de corte cuidadosamente en sentido axial hacia arriba, fuera del asiento de placa de corte, y extraerla. Extraer las demás placas de corte.



3. Limpiar los asientos de plaquitas con aire comprimido y limpiar los asientos de plaquitas utilizando correctamente alcohol de limpieza. Limpiar las superficies de apoyo de las placas de corte con una masa de limpieza.

Nota:

¡Durante el cambio de placas de corte siempre deben insertarse o sustituirse todas las placas de corte!

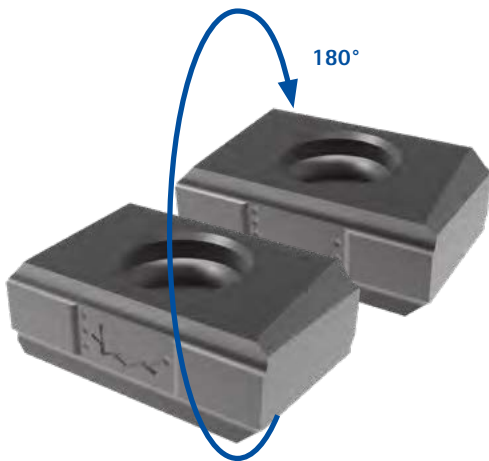

Nota:

Al invertir la placa de corte, observar el orden de los filos de corte con ayuda de los puntos de marcado (de uno a cuatro puntos).



4. Colocar la placa de corte nueva o insertada hasta la mitad del asiento de placa. A continuación, presionar la placa de corte con el dedo pulgar ligeramente dentro del asiento de placa y, al mismo tiempo, desplazar la placa de corte axialmente hacia abajo, dentro del asiento de placa. A continuación, fijar la placa de corte con el tornillo TORX® PLUS.



5. Apretar el tornillo TORX® PLUS con el par de apriete especificado en sentido horario.

Nota:

Apretar los tornillos TORX® PLUS únicamente con una llave dinamométrica adecuada. El par de apriete para los tornillos TORX® PLUS es de 3,5 Nm.

Resultado:

Las placas de corte están completamente cambiadas y la herramienta está lista para usarse.

Indicaciones de ajuste para escariadores de un filo WP

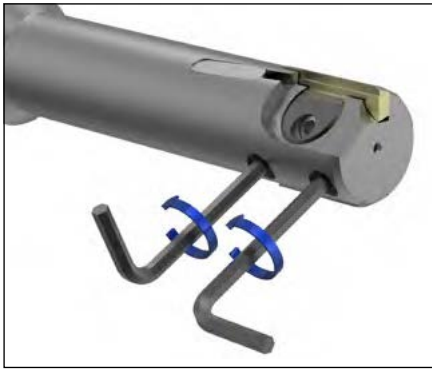
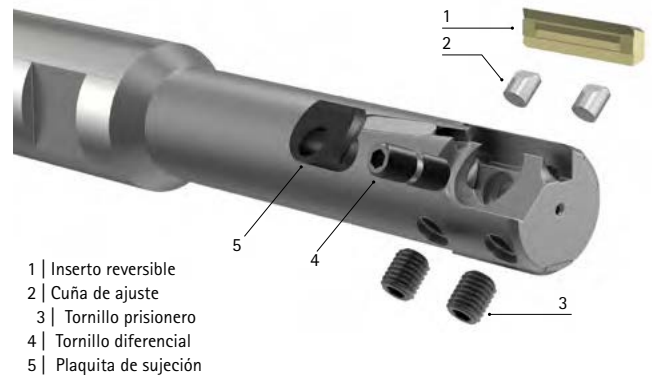

1. Girar los dos tornillos prisioneros 1/2 vuelta en sentido antihorario.



2. Cómo soltar la plaquita de sujeción
Girar el tornillo diferencial 2-3 vueltas en sentido antihorario desde ambos lados (el inserto reversible apunta hacia abajo).

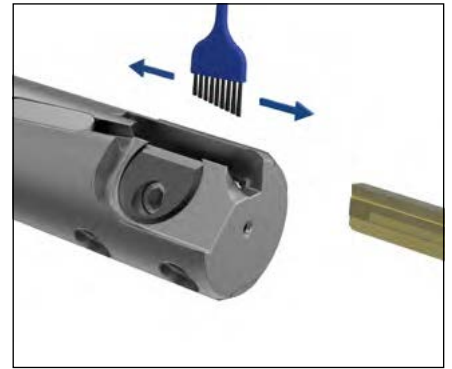

3. Extraer el inserto reversible.

4. Limpiar el inserto reversible y su asiento.

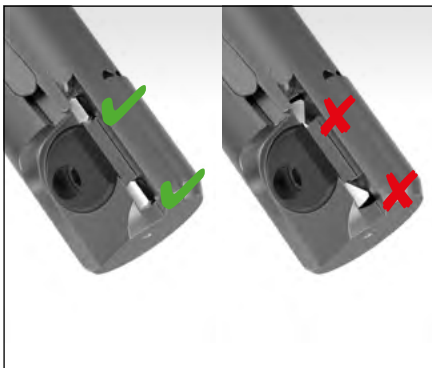

5. Comprobar que las cuñas de ajuste estén colocadas en posición recta.

6. Insertar el inserto reversible nuevo o girado en su asiento.

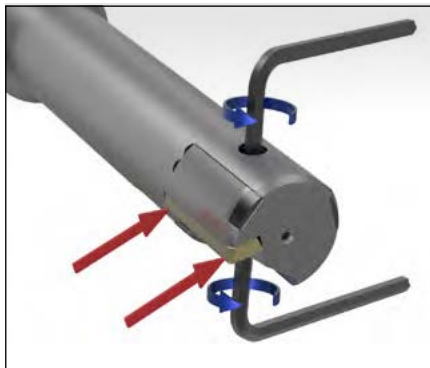

7. Mantener el inserto reversible presionado y apretar el tornillo diferencial en sentido horario desde ambos lados hasta el par de apriete requerido.

8. Girar ambos tornillos prisioneros 1/4 de vuelta en el sentido horario.

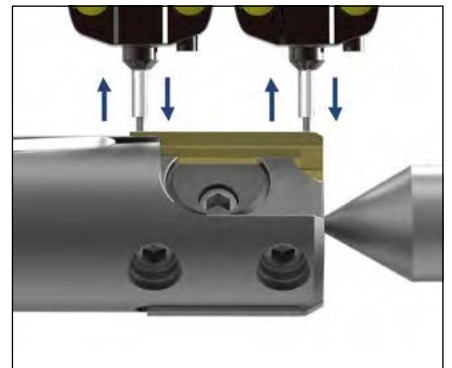

9. Ajustar las medidas de ajuste delantera y trasera en intervalos alternativos por medio de los tornillos prisioneros. Estrechamiento hacia atrás de aprox. 1 µm/mm.

NOTA:

Puede encontrar un resumen de los pares de apriete en formato PDF en la página web de MAPAL:

www.mapal.com → Mediateca → Instrucciones e indicaciones de manipulación → Información técnica general → Pares de apriete para los tornillos de sujeción MAPAL

Indicaciones de ajuste para escariadores de un filo HX

Tamaño 2 y tamaño 3

- | | |
|---------------------------|-------------------------|
| 1 Plaquita de sujeción | 4 Cartucho |
| 2 Tornillo diferencial | 5 Cuña de ajuste |
| 3 Inserto reversible HX | 6 Tornillo prisionero |

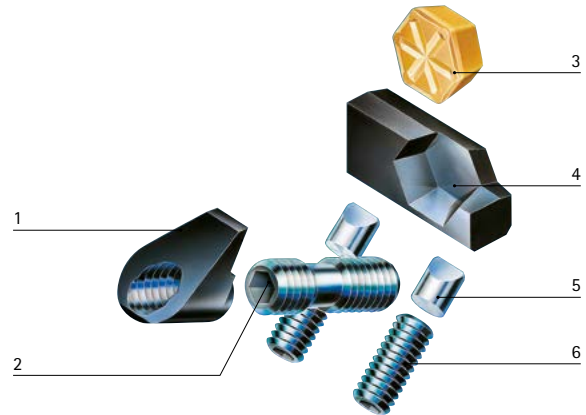

Cambio de insertos reversibles y ajuste

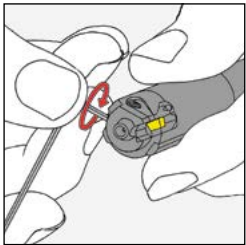

1. Girar los tornillos prisioneros anterior y posterior media vuelta a la izquierda.

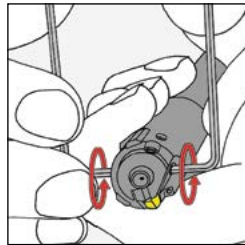

2. **Nota:** Para abrir tienen que utilizarse dos llaves. Para soltar la plaquita de sujeción y el cartucho, girar el tornillo diferencial en el sentido horario y en sentido contrario.

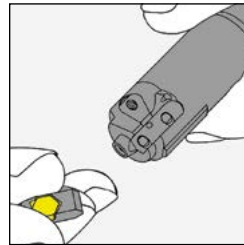

3. Extraer el inserto reversible y el cartucho. Limpiar el inserto reversible, el cartucho y el asiento de el inserto reversible (no utilizar aire comprimido, observar las cuñas de ajuste). Continuar girando el inserto reversible 60° o insertar un inserto reversible nuevo en el cartucho. Volver a montar el cartucho.

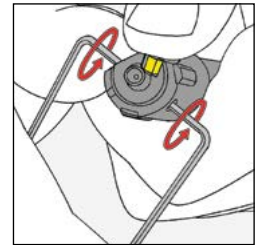

4. **Nota:** Para apretar tienen que utilizarse dos llaves. Presionar el inserto reversible y el cartucho contra el tope posterior y la cuña de ajuste. Girar el tornillo diferencial desde arriba a la derecha y desde abajo a la izquierda, y apretar.

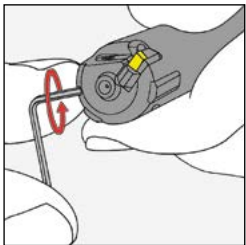

5. Para el ajuste aproximado, girar los tornillos prisioneros anterior y posterior un cuarto de vuelta a la derecha.

Para una manipulación sencilla y una seguridad de ajuste garantizada, recomendamos la utilización de un dispositivo de ajuste MAPAL.

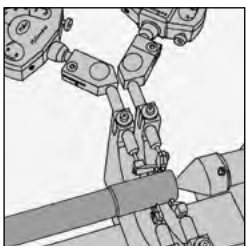

7. Calibrar el MAPAL MASTERSET con el mandril de ajuste (debe pedirse por separado). El mandril de ajuste tiene la medida mínima del agujero.

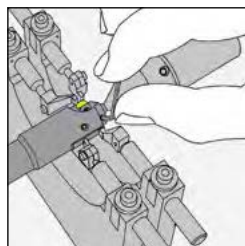

8. Ajustar las medidas de ajuste delantera y trasera en intervalos alternativos por medio de los tornillos prisioneros. El estrechamiento hacia atrás es de aprox. 0,005 a 0,010 mm.

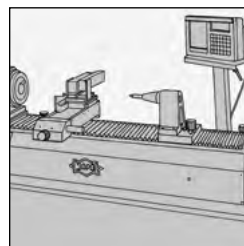

9. MAPAL UNISSET Para el ajuste confortable de los escariadores, MAPAL ofrece unos dispositivos de ajuste electrónicos de diseño vertical y horizontal.

Encontrará más información en el catálogo «AJUSTE | MEDICIÓN | ENTREGA».

Para las indicaciones de ajuste detalladas, consulte el manual de uso del dispositivo.

Información de manipulación del sistema EasyAdjust

Sustituir y ajustar un inserto reversible

El sistema EasyAdjust permite un cambio de insertos reversibles sencillo a la par que rápido. Para poder sustituir y ajustar con precisión micrométrica un inserto reversible solo se requieren un par de pasos.



1. Soltar la cuña de ajuste con una llave Allen y girarla media vuelta en sentido antihorario.

Observación:

Uso solo para personal cualificado.



2. **Nota:** para soltar son necesarias dos llaves Allen.

Para soltar la garra de fijación, girar la llave Allen 1 en sentido antihorario y la llave Allen 2 en sentido horario.



3. Presionar el cartucho junto con la cuña de ajuste hacia delante, en dirección a la herramienta.



4. Extraer el inserto reversible del cartucho.

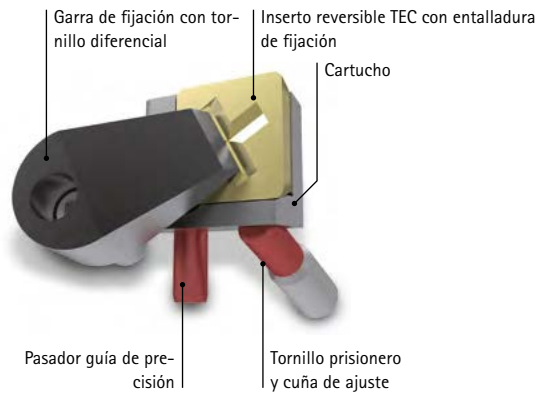
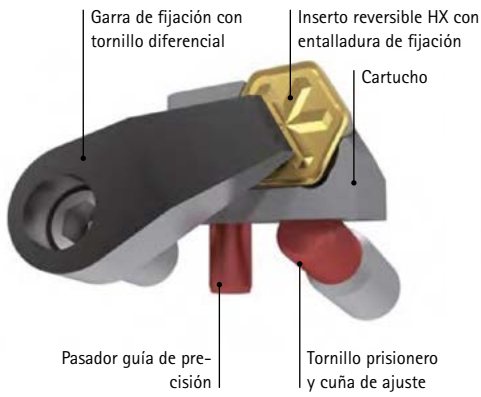

5. Sustituir o girar el inserto reversible. A continuación, colocar el inserto reversible en el cartucho.



6. **Nota:** Para apretar son necesarias dos llaves Allen.

Para apretar la garra de fijación, girar la llave Allen 1 en sentido horario y la llave Allen 2 en sentido antihorario.

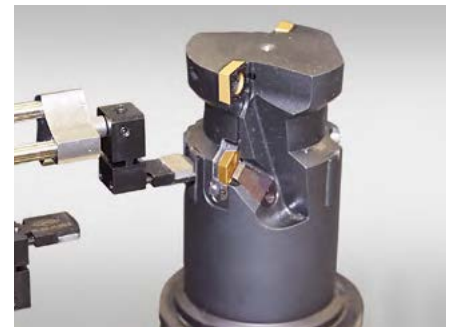

7. **Nota:** Continuar con la medición de la distancia radial o con la medición absoluta.

Sujetar la herramienta en el amarre de un dispositivo de ajuste. Desplazar el palpador de medida al punto más alto de la guía de apoyo y poner a cero el valor medido en este punto.

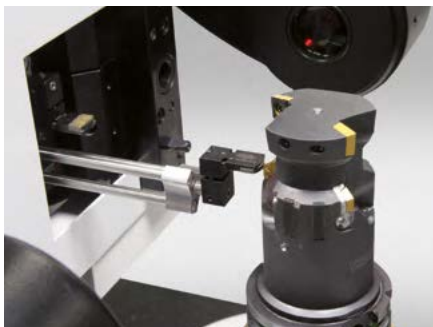

8. Desplazar el palpador de medida al punto más alto del inserto reversible.



9. Ajustar la medida de distancia radial o la medida absoluta del inserto reversible, girar a tal efecto el tornillo prisionero en sentido horario con una llave Allen.



Resultado:

La medida de distancia radial o la medida absoluta deseada del inserto reversible está ajustada.

Instrucciones de montaje y ajuste para escariador exterior con sistema EA



Cambiar el inserto reversible

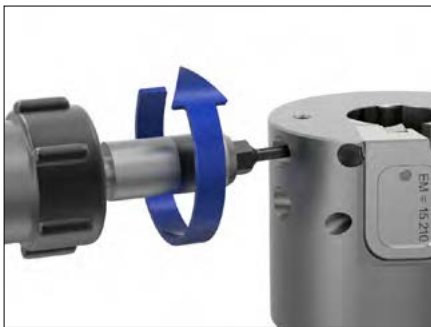

1. Girar los dos tornillos de fijación TORX® en sentido antihorario y extraer el cartucho.



2. Reajustar el inserto reversible al ajuste básico: Girar el tornillo de ajuste media vuelta en sentido antihorario.



3. Girar el tornillo de seguridad 1,5 vueltas en sentido antihorario.



4. Extraer el inserto reversible. Limpiar el asiento del inserto reversible y el inserto reversible TEC.

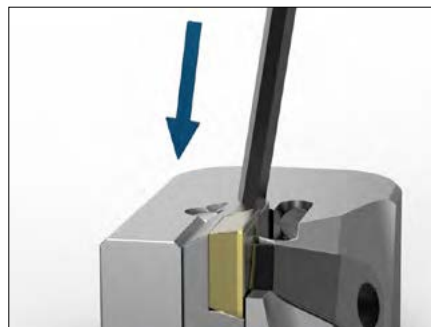

5. Insertar el inserto reversible nuevo o girado en su asiento, prestando atención a la presión axial y radial. Empujar el cartucho del inserto reversible ligeramente hacia atrás en la dirección de ajuste.

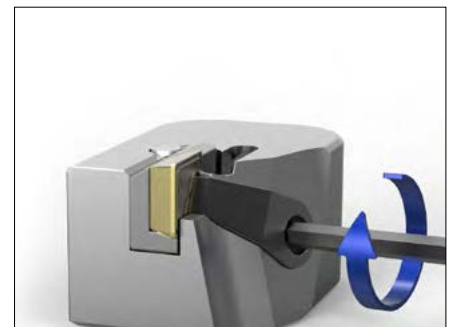

6. Apretar a mano el tornillo diferencial de la garra de fijación en sentido horario.

Ajustar el inserto reversible



7. Ajustar el bloque patrón según el etiquetado del cartucho y poner a cero el botón.

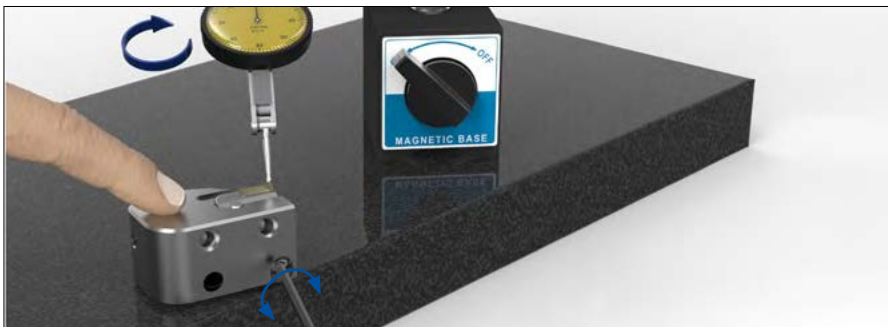

8. Colocar el palpador en el punto más alto del inserto reversible TEC. Girar el tornillo de ajuste en sentido horario hasta que la aguja del reloj comparador esté a cero.

Montaje



9. Introducir el cartucho en su asiento. Apretar ligeramente los dos tornillos de fijación TORX®. A continuación, apretar los tornillos de fijación TORX® con 2,8 Nm.

Solución de problemas para herramientas de taladrado de precisión y escariadores fijos

El agujero no redondo, irregular

Causas		Solución	
Herramienta de taladrado de precisión	Escariadores de múltiples filos		
Saliente ajustado demasiado grande	-	Comprobar/ajustar el ajuste de la herramienta	
-	fz demasiado pequeño/vc demasiado grande	Adaptar los valores de corte, (se recomienda ver el catálogo)	
Avance demasiado grande	-	Comprobar el avance	

El agujero no redondo, repetido

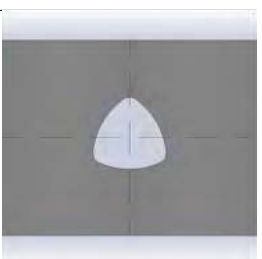
Causas		Solución	
Herramienta de taladrado de precisión	Escariadores de múltiples filos		
Componente tenso (mandril de mordazas típico de polígono)	-	Comprobar la configuración de sujeción/presión de sujeción	
Componente con secciones transversales asimétricas	-	Reducir la presión de corte (estrechamiento mayor, número de dientes menor, entrada más inclinada, avance menor)	

Agujero demasiado grande

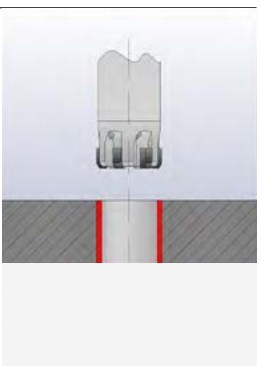
Causas		Solución	
Herramienta de taladrado de precisión	Escariadores de múltiples filos		
Error de concentricidad demasiado grande	-	Comprobar la concentricidad/utilizar el adaptador de alineación	
Mal posicionamiento	-	Comprobar la posición del taladrado	
Recrecimiento del filo	-	Aumentar vc, comprobar lubricante refrigerante/comprobar material de corte/comprobar inclinación de entrada (se recomienda ver el catálogo)	
Vibraciones/oscilaciones	-	Adaptar los parámetros de corte/cota a remover (se recomienda ver el catálogo)	
Saliente demasiado grande	-	Comprobar/corregir el diámetro de ajuste	
-	Diámetro de la herramienta incorrecto	Comprobar el diámetro	

Agujero demasiado pequeño

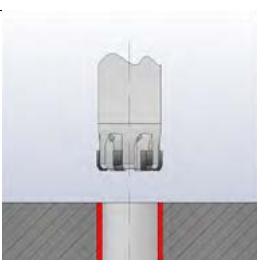
Causas		Solución	
Herramienta de taladrado de precisión	Escariadores de múltiples filos		
Inserto/inserto desgastado	-	Sustitución/reafilado	
Comprobar la profundidad de corte ap (mecanizado previo)	-	Adaptar los valores de corte, se recomienda ver el catálogo	
Componente de pared fina (deformación elástica del componente)	-	Reducir las fuerzas de corte (estrechamiento mayor, número de dientes menor, entrada más inclinada, avance menor)	
Saliente demasiado pequeño	-	Comprobar/reajustar el ajuste	

Entrada cónica | Salida cónica del agujero

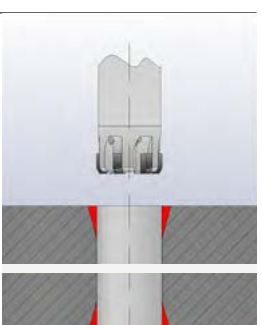
Causas		Solución	
Herramienta de taladrado de precisión	Escariadores de múltiples filos		
Error de concentricidad demasiado grande	-	Comprobar la concentricidad/utilizar el adaptador de alineación	
Problema de posicionamiento/desplazamiento de eje	-	Comprobar la posición del mecanizado previo o la rectitud del eje	
-	Rebasamiento demasiado grande	Longitud máxima de entrada +1 mm de rebasamiento en la salida del agujero	
Avance demasiado grande	-	Comprobar el avance	
Presión KSS demasiado grande	-	Reducir la presión KSS	

Superficie del taladrado incorrecta – irregular

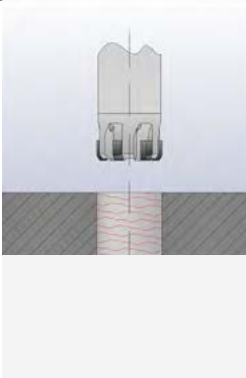
Causas		Solución	
Herramienta de taladrado de precisión	Escariadores de múltiples filos		
Estructura/roturas		Comprobar, sustituir la herramienta o el inserto si es necesario Valores de corte, se recomienda ver el catálogo	
Cota a remover demasiado baja		Comprobar mecanizado previo y cota a remover	
Falta lubricación/refrigeración		Comprobar el suministro KSS/MMS y el contenido de aceite Comprobar la aptitud del aditivo o KSS para este mecanizado	
Retirada de virutas alterada		Aumentar la presión de KSS/adaptar la geometría de corte	
Desgaste		Sustituir el inserto o la herramienta	
Desequilibrio		Comprobar que la combinación de alojamiento/adaptador y herramienta está suficientemente equilibrada	

Superficie del taladrado incorrecta – regular

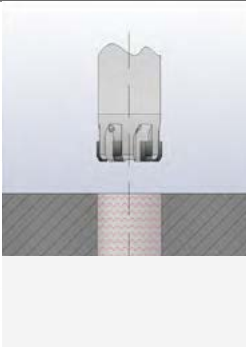
Causas		Solución	
Herramienta de taladrado de precisión	Escariadores de múltiples filos		
Desplazamiento de eje/posicionamiento incorrecto		Comprobar el desplazamiento del agujero y la posición	
fz demasiado pequeño/vc demasiado grande		Adaptar los valores de corte (se recomienda ver el catálogo)	
Relación diámetro/longitud crítica		Comprobar la relación diámetro/longitud crítica	
Influencias del husillo y de la unidad de accionamiento		Modificar parámetros de corte, comprobar inclinación de entrada (se recomienda ver el catálogo)	
Desequilibrio		¿Está suficientemente equilibrada la combinación de alojamiento/adaptador y herramienta?	
Estrechamiento demasiado pequeño		Comprobar/ajustar	
Saliente demasiado grande		Comprobar/ajustar	

Curva del taladrado/forma del cilindro incorrecta

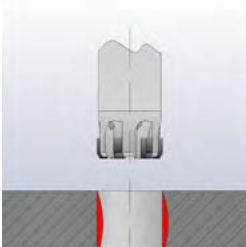
Causas		Solución	
Herramienta de taladrado de precisión	Escariadores de múltiples filos		
Mecanizado previo incorrecto		Comprobar/ajustar, consultar con el departamento especializado/especialista del producto	
Geometría de entrada o herramienta inadecuada		Consulta con el departamento especializado/especialista del producto	
Estrategia de mecanizado no adecuada		Consulta con el departamento especializado/especialista del producto	

La entrada se rompe por completo. En general, se debe consultar a un especialista del producto/empleo de MAPAL

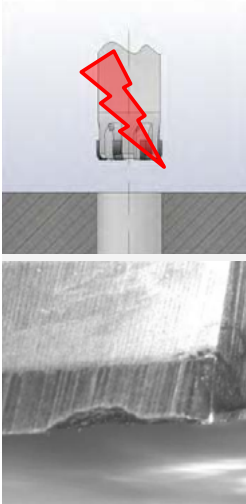
Causas		Solución	
Herramienta de taladrado de precisión	Escariadores de múltiples filos		
Retirada de virutas		Aumentar la presión de KSS/geometría de corte	
Estrechamiento demasiado grande/pequeño		Comprobar/ajustar	
Cota a remover ap demasiado grande		Comprobar/ajustar	
Desgaste demasiado grande		Sustituir el inserto o la herramienta	
Vibraciones		Determinar y eliminar la causa	
Valores de corte incorrectos		Adaptar los valores de corte (se recomienda ver el catálogo)	
Avance demasiado grande		Reducir el avance si es necesario	

Fórmulas generales de mecanizado por arranque de viruta para el mandrinado

Velocidad y avance

Número de revoluciones	$n = \left[\frac{1}{\text{min}} \right]$	$n = \frac{v_c \cdot 1000}{\pi \cdot D_c}$
Velocidad de corte	$v_c = \left[\frac{\text{m}}{\text{min}} \right]$	$v_c = \frac{\pi \cdot D_c \cdot n}{1000}$
Velocidad de avance	$v_f = \left[\frac{\text{mm}}{\text{min}} \right]$	$v_f = f_z \cdot z \cdot n$
Avance/diente	$f_z = [\text{mm}]$	$f_z = \frac{v_f}{z \cdot n}$
Avance	$f = [\text{mm}]$	$f = f_z \cdot z$
Número de insertos	z	

Fuerza de corte

Fuerza de corte F_c	$F_c = A \cdot k_c = b \cdot h \cdot k_c$	F_c en N k_c en N/mm ²
Fuerza de corte específica	$k_c = \left[\frac{k_c \cdot 1.1}{h \cdot mc} \right]$	

Magnitudes de arranque de viruta en el mandrinado

Además de la fuerza de corte específica del material, la sección de arranque de viruta A determina esencialmente la fuerza de arranque de viruta. La proporción de avance por inserto f_z y la profundidad de corte a_p son en este caso las magnitudes fundamentales.

Rigen las relaciones siguientes:

Avance	$f = [\text{mm}]$	$f = f_z \cdot z$
Ángulo de ajuste	$\kappa = [^\circ]$	$\kappa = \frac{\sigma}{2}$
Anchura de arranque de viruta	$b = [\text{mm}]$	$b = \frac{a_p}{\sin \kappa}$
Espesor de viruta	$h = [\text{mm}]$	$h = f_z \cdot \sin \kappa$
Profundidad de corte	$a_p = [\text{mm}]$	$a_p = \frac{(D - d)}{2}$

En la figura se muestra la sección de arranque de viruta A en el mandrinado.

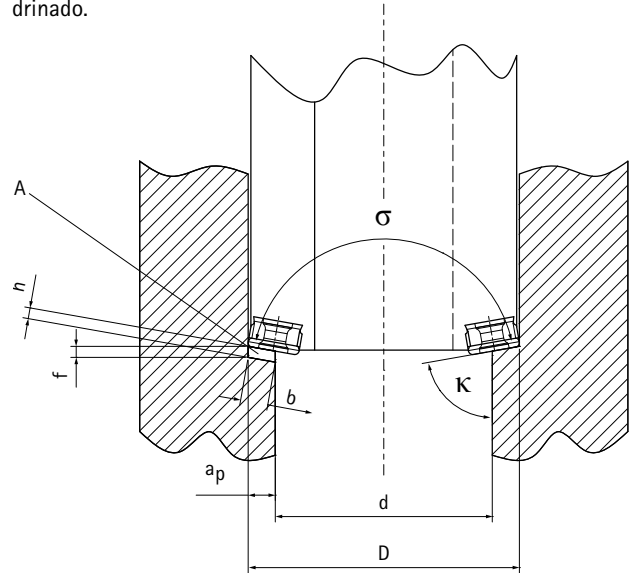

Sección de arranque de viruta para el mandrinado $A = [\text{mm}^2]$

$$A = \frac{(D - d) \cdot f_z}{2}$$

o bien

$$A = a_p \cdot f_z$$

Cálculo de la fuerza de corte en el mandrinado

Simplificado

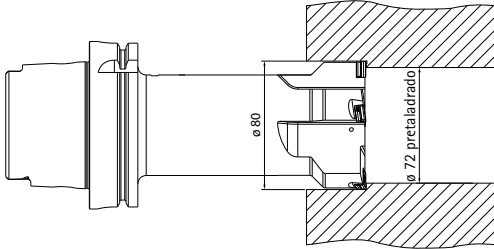

Ejemplo de cálculo:

Herramienta de mandrinado hasta $\varnothing 80$ mm;
 $Z = 5$; $\varnothing 72$ mm pretaladrado, $\kappa = 90^\circ$

Material: EN-GJL-250
 $k_{c1.1^*} = 1160$, $M_c = 0,26$
 $v_c = 200$ m/min, $f_z = 0,2$ mm
 Embotamiento 30 %

	Fórmula básica	Cálculo	Resultado
1. Número de revoluciones	$n = \frac{V_c \cdot 1000}{\pi \cdot D}$	$n = \frac{200 \cdot 1000}{\pi \cdot 80}$	$n = 800$ 1/min
2. Profundidad de corte	$a_p = \frac{(D - d)}{2}$	$a_p = \frac{(80 - 72)}{2}$	$a_p = 4$ mm
3. Sección de arranque de viruta	$A = a_p \cdot f \cdot z$	$A = 4 \text{ mm} \cdot 0,2 \text{ mm} \cdot 5$	$A = 4$ mm ²
4. Espesor de viruta	$h = f_z \cdot \sin \kappa$	$h = 0,2 \text{ mm} \cdot \sin 90^\circ$	$h = 0,2$ mm
5. Fuerza de corte específica sin factor de embotamiento	$k_c = \frac{k_{c1.1}}{h^{m_c}}$	$k_c = \frac{1160}{0,2^{0,26}}$	$k_c = 1763$ N/mm ² con un embotamiento del 30%: $1763 \text{ N/mm}^2 \times 1,3 = 2292 \text{ N/mm}^2$
6. Fuerza de corte	$F_c = A \cdot k_c = b \cdot h \cdot k_c$	$F_c = 4 \text{ mm}^2 \cdot 2292 \text{ N/mm}^2$	$F_c = 9,17$ kN
7. Par de corte d_m = diámetro promedio en metros	$M_c = F_c \cdot \frac{d_m}{2}$	$M_c = 9167,3 \text{ N} \cdot \frac{0,076 \text{ m}}{2}$	$M_c = 348,3$ Nm
8. Potencia de corte	$P_c = \frac{2 \cdot \pi \cdot n \cdot M_c}{60s}$	$P_c = \frac{2 \cdot \pi \cdot 800 \text{ min}^{-1} \cdot 348,3 \text{ Nm}}{60s}$	$P_c = 29,2$ kW

*Valor a partir del cálculo de la fuerza de corte, WTO GmbH

Nota: La eficacia del accionamiento del husillo principal no se tiene en cuenta. MAPAL puede realizar los cálculos de potencia correspondientes.

Selección de la máquina herramienta

Comparación con el par de giro y la potencia de la máquina herramienta

A continuación se muestran dos diagramas: número de revoluciones/potencia.

El número de dientes y los parámetros de corte deben especificarse dependiendo de la máquina.

En el ejemplo de cálculo, la máquina con el husillo de motor no es apropiada, ya que con un número de revoluciones de 800 r.p.m. solo se alcanzan un par de giro de 187 Nm y una potencia de aprox. 20 kW (Figura 1).

Husillo de motor (Figura 1)

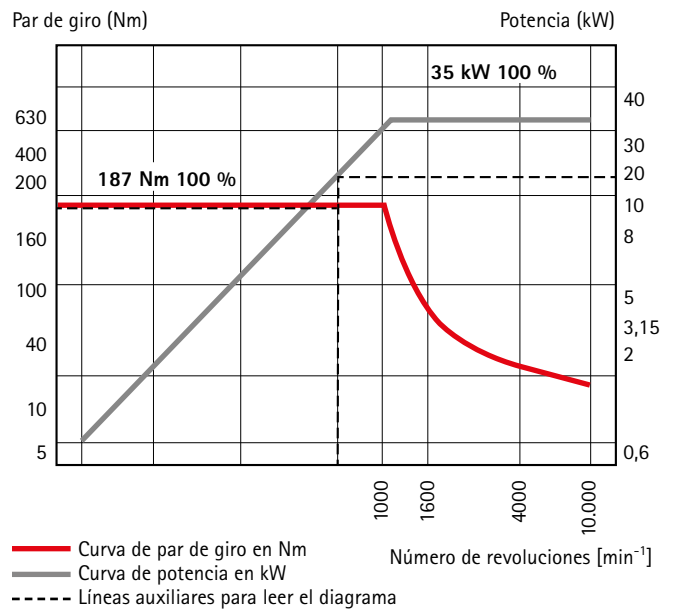

Solución:

Reducir el número de dientes, la velocidad de corte y el avance, dividir el corte en dos herramientas o seleccionar una máquina más potente (p. ej. con husillo de engranajes, Figura 2).

Husillo de engranajes (figura 2)

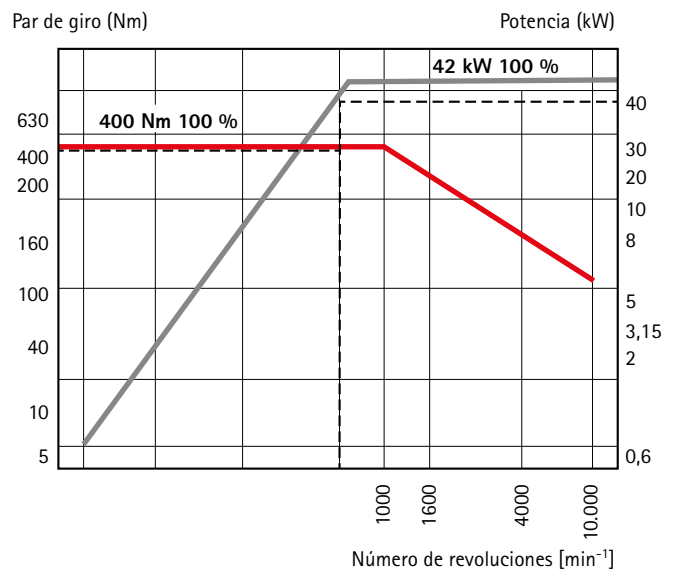

Valores de referencia del diámetro de mandrinado mínimo – radial

En función del número de dientes y el inserto de corte

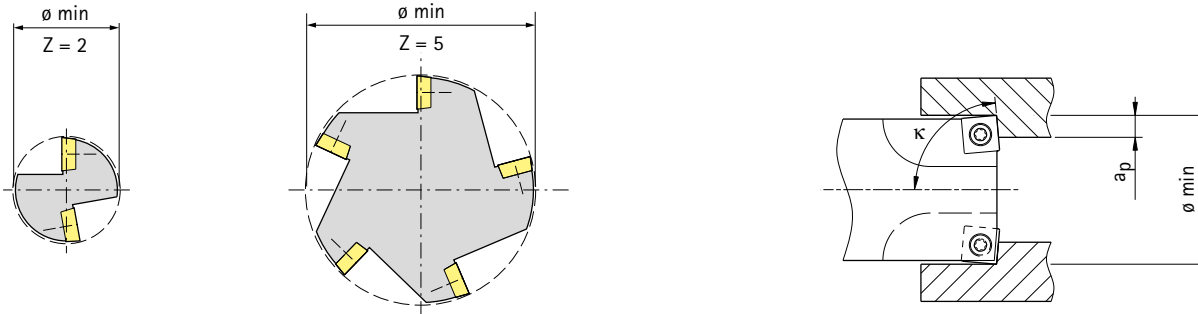

Filos de mandrinado radiales sin afilado con forma de arco

Forma de inserto de corte	Tamaño del inserto de corte reversible				Número de dientes	Observación
	0603	09T3	1204			
S (90°)	Diámetro de mandrinado mínimo con κ 85°					Adecuado para agujero pasante
	17	25	28		1	
	17	25	31		2	
	23	32	39		3	
	31	43	53		4	
	51	63	73		5	
C (80°)	0602	09T3	1204			Adecuado para mecanizado de hombro de 90°
	Diámetro de mandrinado mínimo con κ 90°					
	17	24	28		1	
	18	26	33		2	
	23	34	41		3	
	31	45	54		4	
49	63	77		5		
T (60°)	06T1	0902	1102	16T3		Adecuado con restricciones para agujeros pasantes y mecanizado de hombro de 90°
	Diámetro de mandrinado mínimo con κ 90°					
	15	17	17	24	1	
	18	21	24	37	2	
	21	25	28	43	3	
	27	34	37	57	4	
37	51	67	76	5		

Valores de referencia del diámetro de mandrinado mínimo – tangencial

En función del número de dientes y el inserto de corte

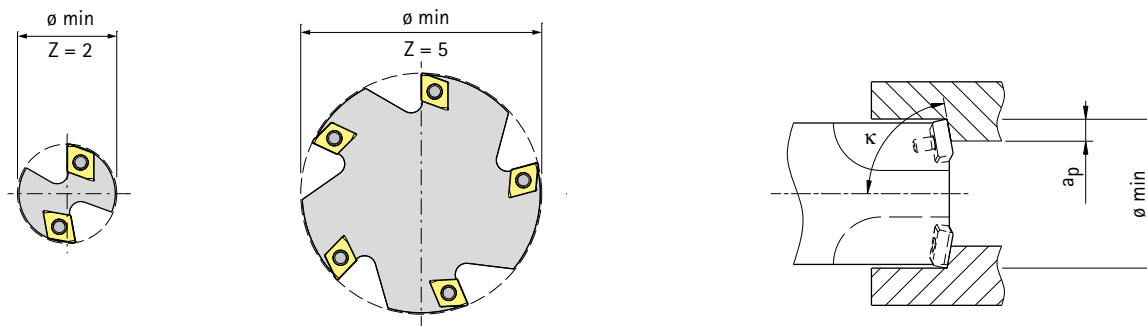

Filos de mandrinado tangenciales sin afilado con forma de arco

Forma de inserto de corte	Tamaño del inserto de corte reversible			Número de dientes	Observación
	0603/0604	09T3/0905	1204/1206		
C (80°)	Diámetro de mandrinado mínimo con κ 80° y 90°				
	28	41	54	1	Adecuado para agujeros pasantes y mecanizado de hombro de 90°
	28	41	54	2	
	30	41	54	3	
	40	56	64	4	
	59	84	94	5	

Filos de mandrinado tangenciales con afilado con forma de arco

Forma de inserto de corte	Tamaño del inserto de corte reversible			Número de dientes	Observación
	0604	0905	1206		
C (80°)	Diámetro de mandrinado mínimo con κ 80° y 90°				
	40	65	78	1	Adecuado para agujero pasante y mecanizado de hombro de 90°
	40	65	78	2	
	40	65	78	3	
	41	65	78	4	
	64	86	102	5	

Filos de mandrinado tangenciales con y sin afilado con forma de arco

Forma de inserto de corte	Tamaño del inserto de corte reversible			Número de dientes	Observación
	0604	0905	1206		
F (70°)	Diámetro de mandrinado mínimo con κ 80° y 90°				
	22	30	40	1	Adecuado para agujeros pasantes y mecanizado de hombro de 90°
	22	30	40	2	
	31	43	53	3	
	42	56	67	4	
	64	83	99	5	

Solución de problemas

Formas de desgaste de los insertos de corte

Forma de desgaste

Desgaste de la cara de incidencia

Tangencial



radial

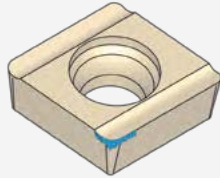

Desgaste por craterización

Tangencial



radial

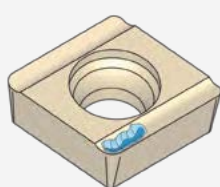

Desgaste por entalla

Tangencial



radial

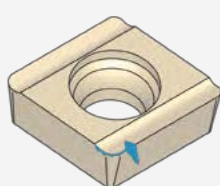

Recrecimiento del filo

Tangencial

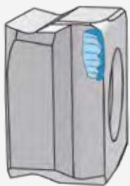

radial

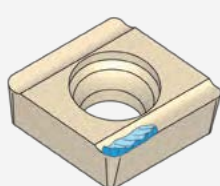

Roturas

Tangencial



radial

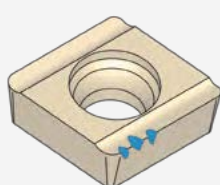

Rotura de los insertos

Tangencial



radial

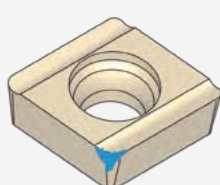

Soluciones

- Reducir la velocidad de corte
- Seleccionar una clase de materiales de corte más resistente al desgaste

- Reducir el avance
- Reducir la velocidad de corte
- Seleccionar una clase de materiales de corte más resistente al desgaste
- Utilizar refrigerante

- Reducir la velocidad de corte
- Seleccionar un ángulo de ajuste menor
- Reducir el avance

- Aumentar la velocidad de corte
- Aumentar el avance
- Seleccionar una geometría de corte fácil (insertos afilados)

- Aumentar la velocidad de corte
- Reducir el avance
- Seleccionar una clase de metal duro más tenaz
- Seleccionar una geometría más fuerte
- Mejorar la estabilidad (por ejemplo, herramienta corta)
- Refrigeración, continua o seca (evitar el termochoque)

- Reducir el avance
- Reducir la profundidad de corte
- Seleccionar una geometría más fuerte del inserto de corte
- Seleccionar una clase de metal duro más tenaz
- Seleccionar una placa de corte más gruesa

De la práctica – Solución de problemas en el mandrinado

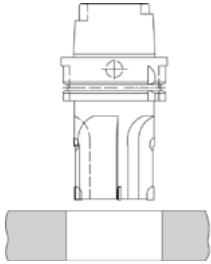
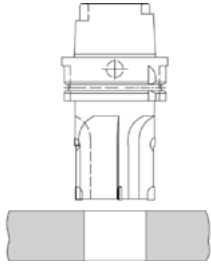
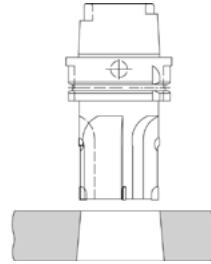
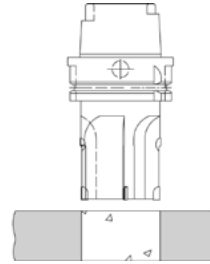
El agujero se hace demasiado grande	El agujero se hace demasiado pequeño	El agujero se hace cónico	Superficie deficiente en el agujero
<p>¿Causa?</p> <ul style="list-style-type: none"> - Diámetro de herramienta quizá demasiado grande - Velocidad de corte demasiado alta - Avance demasiado alto - Error de concentricidad demasiado grande - Entrada irregular - Lubricante refrigerante inadecuado 	<p>¿Causa?</p> <ul style="list-style-type: none"> - Herramienta desgastada - Velocidad de corte demasiado baja - Avance demasiado bajo - Material dúctil, se contrae después del mecanizado - Cota a remover demasiado baja 	<p>¿Causa?</p> <ul style="list-style-type: none"> - Error de concentricidad demasiado grande - Entrada incorrecta - Mecanizado previo incorrecto 	<p>¿Causa?</p> <ul style="list-style-type: none"> - Lubricante refrigerante inadecuado - Recrecimiento en el inserto - Herramienta embotada, posible astillamiento del inserto - Retirada de virutas deficiente - Desequilibrio residual demasiado grande
			

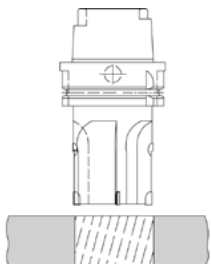
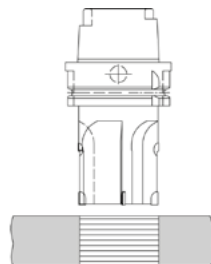
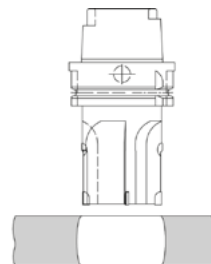
El agujero tiene marcas de vibraciones	El agujero presenta estrías de avance	El agujero se abomba
<p>¿Causa?</p> <ul style="list-style-type: none"> - Recrecimiento en el inserto - Herramienta embotada - Lubricante refrigerante inadecuado - Error de concentricidad demasiado grande - Desequilibrio residual demasiado grande - Configuración de sujeción incorrecta 	<p>¿Causa?</p> <ul style="list-style-type: none"> - Herramienta embotada, posible astillamiento del inserto - Recrecimiento en el inserto - Lubricante refrigerante inadecuado 	<p>¿Causa?</p> <ul style="list-style-type: none"> - Pieza sujeta incorrectamente
		



Pictogramas

Barrenado en solido >

	Barrenado en solido		Taladrado		Taladrado escalonado		Taladrado profundo
	Escariado H7		Mecanizado de alto avance HFC		Mecanizado a alta velocidad HSC		Taladrado de paquetes
	Taladrado transversal		Entrada inclinada en el agujero		Salida inclinada del agujero		Fondo del agujero plano 180°
	Agujero roscado del núcleo		Agujero piloto		Máxima tolerancia de taladrado alcanzable $\geq IT$		Serie preferente en H7
	Tolerancia del diámetro de afilado de la herramienta		Profundidad de taladrado máxima 3xD		Suministro de refrigerante		Interfaz CFS
	Con inserto de corte		Interfaz QTS		Interfaz TTS-100		Interfaz TTS-300
	Forma del mango HA según DIN DIN 6535		Forma del mango HB según DIN DIN 6535		Forma del mango HE según DIN DIN 6535		

Escariado y taladrado de precisión >

	Agujero pasante		Agujero ciego		Sistema de sujeción axial HFS		Sistema de sujeción radial HFS
	Serie preferente en H7		Máxima tolerancia de taladrado alcanzable $\geq IT$		Tolerancia del diámetro de afilado de la herramienta		Escariador de un filo
	Plaquita reversible WP		Suministro de refrigerante		Interfaz HFS		Interfaz módulo
	Interfaz HSK-A		Interfaz mango cono Morse (MK)		Mango cilíndrico HA según DIN DIN 6535		Forma del mango HE según DIN DIN 6535
	Mango cilíndrico con plano de sujeción						

Avellanado >

	Avellanador cónico según DIN		Avellanado 90°
--	------------------------------	--	----------------

Configuración >

	Producto con características configurables
--	--

Pictogramas

Clase de productos >



Basic Line:
Herramientas universales, amplia gama de aplicación, costes de adquisición reducidos



Performance Line:
Herramientas de alto rendimiento, amplia gama de aplicación, alta productividad en la fabricación en serie



Expert Line:
Herramientas especializadas para aplicaciones seleccionadas, máxima precisión y productividad

Idoneidad del material >



Muy adecuado



Adecuado con restricciones

Ejemplo: Tabla de idoneidad de materiales estándar

P	1	2	3	4	5	6	M	1	2	3	K	1	2	3	N	1	2	3	4	S	1	2	3	4	5	H	1	2	3
	■	■	■	■							■	■																	

Ejemplo: Tabla de idoneidad de materiales para metales no ferrosos y materiales de construcción ligera

N	1.1	1.2	1.3	1.4	2.1	2.2	2.3	3.1	4.1	4.2	4.3	G	1.1	1.2	1.3	2.1	3.1	4.1	4.2	5.1	5.2	5.3
										■									■			

Grupos de mecanizado de MAPAL

Grupo de mecanizado		Material	Rigidez/dureza [N/mm ²] [HRC]	Materiales mecanizados frecuentemente
P	P1	P1.1 Aceros de construcción, para tornos automáticos, de cementación y revenidos, no aleados	< 700 N/mm ²	1.0122 (S235/St 37), 1.0401 (C15), 1.0503 (C45), 1.0570 (S355/St 52), 1.1213 (Cf53)
		P1.2 Aceros de construcción, para tornos automáticos, de cementación y revenidos, no aleados	< 1200 N/mm ²	1.1249 (Cf70)
	P2	P2.1 Aceros nitrurados, de cementación y aceros revenidos, aleados	< 900 N/mm ²	1.7131 (16MnCr5)
		P2.2 Aceros nitrurados, de cementación y aceros revenidos, aleados	< 1400 N/mm ²	1.7227 (42CrMoS4)
	P3	P3.1 Aceros para herramientas, rodamientos, resortes y rápidos*	< 800 N/mm ²	1.2343 (X37CrMoV5-1), 1.2762 (75CrMoNiW6-7)
		P3.2 Aceros para herramientas, rodamientos, resortes y rápidos*	< 1000 N/mm ²	1.2367 (X38CrMoV5-3), 1.2713 (55NiCrMoV6)
		P3.3 Aceros para herramientas, rodamientos, resortes y rápidos*	< 1500 N/mm ²	1.2379 (X153CrMoV12) 1.2738 (40CrMnNiMo8-6-4)
	P4	P4.1 Aceros inoxidables, ferríticos y martensíticos		1.4510 (X3CrTi17), 1.4589 (X5CrNiMoTi15-2)
P5	P5.1 Fundición de acero		1.7231 (G42CrMo4)	
P6	P6.1 Fundición de acero inoxidable, ferrítica y martensítica			
M	M1	M1.1 Aceros inoxidables, austeníticos	< 700 N/mm ²	1.4301 (V2A), 1.4571 (V4A)
		M1.2 Aceros inoxidables, ferríticos/austeníticos (dúplex)	< 1000 N/mm ²	1.4362 (Alloy 2304), 1.4501, 1.4662 (LDX 2404)
	M2	M2.1 Fundición de acero inoxidable, austenítica	< 700 N/mm ²	
	M3	M3.1 Fundición de acero inoxidable, ferrítica/austenítica (dúplex)	< 1000 N/mm ²	
K	K1	K1.1 Hierro fundido con grafito laminar (fundición gris), GJL	< 300 N/mm ²	GJL-250 (GG-25), GJL-260 (GG-26 Cr)
		K2.1 Hierro fundido con grafito esférico, GJS	< 500 N/mm ²	GJS-400 (GGG-40), GJS-450 (GGG-45)
		K2.2 Hierro fundido con grafito esférico, GJS	≤ 800 N/mm ²	GJS-600 (GGG-60), GJS-800-2 (GGG-80), GJS-800-8 (ADI 800)
	K2	K2.3 Hierro fundido con grafito esférico, GJS	> 800 N/mm ²	GJS-900-2 (GGG-90), GJS-1000-5 (ADI 1000), GJS-1200-2 (ADI 1200), GJS-1400-1 (ADI 1400)
		K3.1 Hierro fundido con grafito vermicular, GJV; fundición maleable, GJM	< 500 N/mm ²	GJV-300, GJV-400, GJMW-400-5 (GTW-40)
	K3	K3.2 Hierro fundido con grafito vermicular, GJV; fundición maleable, GJM	> 500 N/mm ²	GJV-500, GJV-700
N	N1	N1.1 Aluminio, aleado y no aleado < 3 % Si		Alloy 2024, Alloy 7075, Al99
		N1.2 Aluminio, aleado ≤ 7 % Si		AlSi7
		N1.3 Aluminio, aleado > 7-12 % Si		AlSi9, AlSi9Cu
		N1.4 Aluminio, aleado > 12 % Si		AlSi12, AlSi17
	N2	N2.1 Cobre, no aleado y de baja aleación	< 300 N/mm ²	SE-Cu
		N2.2 Cobre, aleado	> 300 N/mm ²	CuSn6
		N2.3 Latón, bronce, fundición roja	< 1200 N/mm ²	CuZn33, CuAl9Mn3
	N3	N3.1 Grafito, > 8 μm		
		N3.2 Grafito, ≤ 8 μm		
	N4	N4.1 Plástico, termoplásticos		PA, PE, PC, PS, PVC, PP, PTFE, POM, PMMA
		N4.2 Plástico, plásticos termoestables		PU, PF, EP, UP, VE, CR
		N4.3 Plástico, espumas		EPS, PUR, PVC-E, PS-E, PP-E
C	C1	C1.1 Matriz de plástico, reforzada con fibras de aramida (AFK)		Nomex, Kevlar, Twaron, KOREX
		C1.2 Matriz de plástico (termoestable), CFK/GFK		IMS, HTA
		C1.3 Matriz de plástico (termoplástico), CFK/GFK		GMT-PP, PEEK
	C2	C2.1 Matriz de carbono, reforzada con fibras de carbono (CFC)		CF222, CF225, CF226, CF227, CF260
	C3	C3.1 Matriz metálica (MMC)		CeramTec AO-403 (AlSi9MgMn-Al2O3), Al/Cu/Mg-SiO2/AI2O3/AIN/TiC/SiC/BN/TiB2
	C4	C4.1 Construcción tipo sándwich, núcleo de panal (nido de abeja)		
		C4.2 Construcción tipo sándwich, núcleo de espuma		PLASCORE PAMG-XR1 5052, PCGA-XR1 3003, PAMG-XR1 5056, Micro-Cell (core made of Alloy 5052/5066)
	C5	C5.1 Material compuesto (stack), material compuesto de no metal/metal no ferroso		Aluminio CFK, IMS/HTA + Alloy 2024/6061/7075
		C5.2 Material compuesto (stack), material compuesto de no metal/metal		CFK-Titan, IMS/HTA + TiAl6V4/AMS4905
		C5.3 Material compuesto (stack), material compuesto de no metal/no metal		CFK-CFK
		C5.4 Material compuesto (stack), material compuesto de metal no ferroso/metal no ferroso		Aluminio-aluminio
		C5.5 Material compuesto (stack), material compuesto de metal no ferroso/metal		Aluminio-titanio
C5.6 Material compuesto (stack), material compuesto de metal/metal			Titanio inoxidable	
S	S1	S1.1 Titanio, aleaciones de titanio	< 400 N/mm ²	
		S2.1 Titanio, aleaciones de titanio	< 1200 N/mm ²	TiAl6V4
	S2	S2.2 Titanio, aleaciones de titanio	> 1200 N/mm ²	
		S3.1 Níquel, no aleado y aleado	< 900 N/mm ²	1.3912 (Invar, Ni36)
	S3	S3.2 Níquel, no aleado y aleado	> 900 N/mm ²	
		S4.1 Superaleación de gran resistencia al calor basada en Ni, Co y Fe		Hardox, Hastelloy, Incoloy, Inconel, NIMONIC, Stellite, Waspaloy
S5	S5.1 Aleaciones de wolframio y molibdeno			
H	H1	H1.1 Acero templado/fundición de acero	< 44 HRC	1.2738 HH, 1.2085, Toolox 33, Toolox 44
		H1.2 Acero templado/fundición de acero	< 55 HRC	1.2343, 1.2311, 1.2312, 1.2714, 1.2083, 1.2738
	H2	H2.1 Acero templado/fundición de acero	< 60 HRC	1.1730, 1.2379, 1.2358, 1.2767, 1.4112, ASP 2012
		H2.2 Acero templado/fundición de acero	< 65 HRC	1.2379, 1.2363, 1.2436, 1.2842, ASP 2005, Vanadis 23
	H2	H2.3 Acero templado/fundición de acero	< 68 HRC	ASP 2017, ASP 2023, Vanadis 30, Vanadis 60
		H3	H3.1 Fundición/fundición dura resistente al desgaste, GJN	

* Si los componentes de aleación de Cr, Mo, Ni, V, W suman > 8 %, elegir el siguiente grupo de mecanizado MAPAL superior.



Descubra ahora las soluciones de herramientas y servicio que le harán avanzar:

MECANIZADO DE AGUJEROS

ESCARIADO | TALADRADO DE PRECISIÓN

BARRENADO EN SOLIDO | MANDRINADO | AVELLANADO

FRESADO

SUJECCIÓN

TORNEADO

HERRAMIENTAS ACCIONADAS

AJUSTE | MEDICIÓN | ENTREGA

SERVICIOS